

WICSTYLE evo

Türsysteme

Door systems

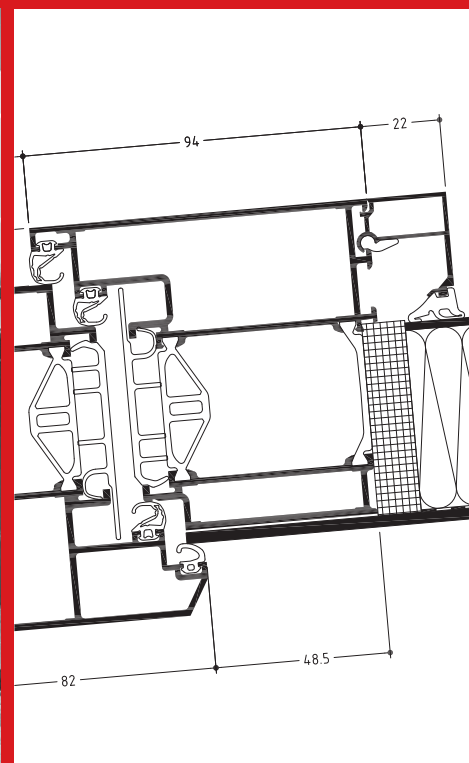

Programm 09.2015
Product range



Die in dieser Dokumentation enthaltenen Daten und Hinweise entsprechen den uns bekannten Informationen zum Zeitpunkt der Drucklegung. Eine Haftung für die hier enthaltenen Informationen ist ausgeschlossen, es sei denn, die Fehler beruhen auf Vorsatz oder grober Fahrlässigkeit seitens unseres Unternehmens.

Die in den Unterlagen dargestellten und beschriebenen Produkte und Anwendungen sind für Fachunternehmen ausgelegt. Sämtliche Beschreibungen erfolgen als Serviceleistung ohne Anerkennung von Rechtspflichten und entbinden nicht von eigener Prüfung bei der Verwendung für Zwecke des Anwenders. Branchenübliche Fachkenntnisse sowie Kenntnis des aktuellen gültigen Standes der Technik werden als bekannt vorausgesetzt und daher nicht gesondert beschrieben oder erläutert.

Die Benutzung des Markenzeichens WICONA® ist nur zulässig, sofern ausschließlich die in den jeweils gültigen WICONA-Profilprogrammen aufgenommenen Konstruktionsteile (Profile, Zubehör und Beschläge) verwendet werden. Die Echtheit der Artikel bzw. Teile und die Einheit der Konstruktion ist erkennbar durch die entsprechende Kennzeichnung bei diesen Teilen. Von Sapa Building Systems entwickelte und geprüfte WICONA-Systeme für Fassaden, Fenster und Türen erhalten mit entsprechenden Prüfungen und Prüfzeugnissen durch anerkannte Institute ihre endgültige Bestätigung. Für jeden verarbeitenden Fachbetrieb sind diese Prüfzeugnisse und Dokumentationen verpflichtende Arbeitsrichtlinien. Bei festgestellten Mängeln, die an WICONA Fassaden, -Fenstern und -Türen sichtbar werden, weil systemfremde Teile verwendet wurden, wird in diesen Fällen jede Haftung durch Sapa Building Systems ausgeschlossen. Desweiteren verlieren die attestierte Prüfzeugnisse für diese Elemente ihre Gültigkeit.

Bitte beachten Sie auch die „Wichtigen Hinweise“ im Vorspann unserer Profilprogramme und Verarbeitungsrichtlinien.

Sapa Building Systems

® = eingetragene Markenzeichen
Sapa Building Systems

The data and instructions contained in this documentation correspond to the information known to us at the time of printing. There is no liability on our part for the information contained herein, unless the errors are deliberate on our part or attributable to gross negligence by our company.

The products and applications shown and described in these documents are designed for specialist companies. All descriptions are provided as a service, without admitting legal responsibility, and do not release the user from the need to check that a product or application is suitable for the particular purpose envisaged. Specialist knowledge customary in this branch of business and awareness of the latest technology are assumed and consequently are not separately described or explained.

Use of the trademark WICONA® is permitted only if the structural parts included in the applicable WICONA profile programmes (profiles, accessories and fittings) are exclusively used. The genuineness of the items or parts and the uniformity of the design is identifiable by the corresponding markings on these parts. WICONA systems developed and tested by Sapa Building Systems for facades, windows and doors are ultimately qualified by the appropriate tests and test certificates from recognised institutes. Each processing company is subject to these test certificates and documentation as mandatory work guideline specifications. Sapa Building Systems is not liable for any defects visible on WICONA facades, windows and doors and attributable to the use of parts not belonging to the system or to a lack of maintenance of these products. The corresponding test certificates also lose their validity for these items.

Please also note the "Important indications" in the opening sections of our profile programmes and processing guideline specifications.

Sapa Building Systems

® = registered trademarks
Sapa Building Systems

1 Technischer Vorspann / *Technical Prefix*

Nummernverzeichnis, Wichtige Hinweise, Öffnungsarten, Symbole und Hinweise, Technische Informationen
Numerical index, Important indications, Opening types, Symbols and indications, Technical Information

2 WICSTYLE 75 evo

Serienbeschreibung, Profilübersicht, Profile, Anwendungsbeispiele, Glasleistenprofile - Auswahltabellen, Zulässige Flügelgrößen
Description of series, Survey of profiles, Profiles, Examples of application, Glazing bead profiles - Selection tables, Admissible sash sizes

3 WICSTYLE 65 evo / 65

Serienbeschreibung, Profilübersicht, Profile, Anwendungsbeispiele, Glasleistenprofile - Auswahltabellen, Zulässige Flügelgrößen
Description of series, Survey of profiles, Profiles, Examples of application, Glazing bead profiles - Selection tables, Admissible sash sizes

4 Profile universell / *Profiles universal*

Glasleistenprofile, Zusatzprofile, Eckwinkelprofile
Glazing bead profiles, Additional profiles, Corner angle profiles

5 Zubehör / *Accessories*

Zubehörübersicht, Dichtungen Meterware / Stückware, Kunststoffprofile / Formstücke, Eckwinkel / Blechteile, Verbinder, Verbindungselemente, Verschiedenes
Survey of accessories, Gaskets metre ware / single parts, Plastic profiles / moulded pieces, Corner angles / Metal sheet parts, Butt joint connectors, Connecting components, Miscellaneous

6 Werkzeuge / *Tools*

Sägebeilagen, Schablonen, Stanzwerkzeuge, Presstawerkzeuge, Verschiedenes, Hilfsstoffe
Sawing shims, Templates, Punching tools, Crimping tools, Miscellaneous, Auxilliary means

7 Kompendium / *Comprisal*

Statikseiten, EN Normen, Statische Werte, Eckwinkelzuschnitt - Auswahltabellen, Zuordnung Gelenkeckwinkel, Zuordnung Gelenkverbinder, Sprossenstoßverbindungen, Informationen zur Durchschusshemmung / Einbruchhemmung, Zertifikate
Static pages, European standards, Statical values, Cutting corner angle - Selection tables, Assignments hinged corner angles, Assignments hinged connectors, crossbar butt-joint connection, Information on bullet resistant / burglar resistant, Certificates

	Seite <i>Page</i>
Nummernverzeichnis <i>Numerical index</i>	N1
Wichtige Hinweise <i>Important indications</i>	1/3
Öffnungsarten <i>Opening types</i>	1/11
Symbole / Hinweise <i>Symbols / Indications</i>	1/13
Zulässige Flügelgrößen <i>Admissible sash sizes</i>	1/13
Profilseiten <i>Profile pages</i>	1/14
Fluchttürverschlusssysteme <i>Emergency exit lock systems</i>	1/16
Abkürzungsverzeichnis <i>List of abbreviations</i>	1/17
Eckverbindungstechnik <i>Corner connection technique</i>	1/18

Artikel-Nr. <i>Article-no.</i>	Seite <i>Page</i>	Artikel-Nr. <i>Article-no.</i>	Seite <i>Page</i>	Artikel-Nr. <i>Article-no.</i>	Seite <i>Page</i>	Artikel-Nr. <i>Article-no.</i>	Seite <i>Page</i>	Artikel-Nr. <i>Article-no.</i>	Seite <i>Page</i>
134026	2/81	1916201	3/47	1917201	2/57	1926518	3/39	1927532	2/89
134026	3/70	1916202	3/47	1917202	2/57	1926520	3/76	3000074	4/15
1010187	3/37	1916203	3/48	1917203	2/58	1926521	3/77	3020190	3/84
1010425	2/34	1916204	3/48	1917204	2/58	1926522	3/77	3020191	3/73
1010463	2/90	1916205	3/49	1917205	2/59	1926523	3/77	3021018	3/85
1010464	2/90	1916206	3/49	1917206	2/59	1926524	3/71	3021033	2/82
1017077	2/33	1916207	3/50	1917207	2/60	1926525	3/71	3021033	3/72
1020442	2/83	1916209	3/50	1917209	2/60	1926526	3/71	3021035	3/82
1020452	3/74	1916211	3/51	1917211	2/61	1926527	3/78	3090098	4/3
1020453	3/74	1916213	3/51	1917213	2/61	1926528	3/78	3090099	4/3
1020457	3/71	1916215	3/52	1917215	2/62	1926529	3/79	3090244	4/13
1020461	2/52	1916220	3/52	1917220	2/63	1926530	3/79	3091052	4/9
1020496	2/82	1916224	3/53	1917224	2/64	1926531	3/79	3091053	4/9
1020497	2/83	1916241	3/55	1917241	2/66	1926532	3/80	3091061	3/85
1020498	2/84	1916244	3/56	1917244	2/67	1926533	3/80	3091062	3/85
1020499	3/33	1916246	3/57	1917246	2/68	1926534	3/43	3091063	3/85
1020500	2/36	1916247	3/58	1917247	2/69	1926535	3/43	3900030	4/15
1020501	2/54	1916248	3/59	1917248	2/70	1926536	3/44	3900043	4/16
1020502	2/37	1916249	3/60	1917249	2/71	1926537	3/80	3900044	4/20
1020503	2/38	1916250	3/61	1917250	2/72	1926538	3/81	3900048	4/15
1020504	2/39	1916251	3/62	1917251	2/73	1926539	3/81	3900049	4/15
1020508	2/44	1916256	3/63	1917256	2/74	1926540	3/44	3900050	4/16
1020509	3/46	1916258	3/64	1917258	2/75	1926541	3/35	3900051	4/17
1020510	2/51	1916259	3/65	1917259	2/76	1926542	3/36	3900052	4/18
1020511	2/50	1916260	3/66	1917260	2/77	1926544	3/36	3900053	4/19
1020512	2/41	1916270	3/67	1917270	2/78	1926545	3/81	3925094	4/10
1020513	2/42	1916271	3/68	1917271	2/79	1926547	3/71	3925095	4/10
1020515	2/53	1916272	3/69	1917272	2/80	1927500	2/34	3925096	4/10
1020533	2/45	1916273	3/69	1917273	2/80	1927501	2/35	3925097	4/10
1020534	2/46	1916301	3/75	1917301	2/84	1927502	2/35	3925099	3/73
1320033	2/56	1916303	3/76	1917303	2/85	1927506	2/40	3925100	3/73
1320034	3/46	1916336	3/53	1917336	2/64	1927507	2/40	3925101	3/83
1916001	3/23	1916338	3/54	1917338	2/65	1927510	2/47	3926500	3/71
1916002	3/23	1917001	2/21	1920512	3/45	1927511	2/47	3926501	3/72
1916003	3/24	1917002	2/21	1920513	2/55	1927512	2/48	3926502	3/72
1916004	3/24	1917003	2/22	1920516	3/45	1927513	2/48	3926504	3/82
1916005	3/25	1917004	2/22	1920517	2/55	1927514	2/49	3926505	3/82
1916009	3/25	1917005	2/23	1926500	3/32	1927515	2/49	3926512	3/72
1916019	3/25	1917009	2/24	1926501	3/32	1927516	2/43	3926513	3/83
1916055	3/26	1917055	2/24	1926502	3/32	1927517	2/43	3927501	2/82
1916056	3/26	1917056	2/24	1926503	3/33	1927518	2/44	3991001	4/3
1916057	3/26	1917057	2/25	1926504	3/33	1927520	2/85	3991002	4/3
1916058	3/27	1917058	2/25	1926505	3/34	1927521	2/86	3991003	4/3
1916059	3/27	1917059	2/25	1926506	3/34	1927522	2/86	3991004	4/3
1916060	3/27	1917060	2/26	1926507	3/35	1927523	2/87	3991005	4/3
1916062	3/28	1917062	2/27	1926510	3/40	1927524	2/82	3991006	4/3
1916064	3/28	1917064	2/28	1926511	3/40	1927525	2/82	3991007	4/3
1916067	3/29	1917067	2/29	1926512	3/41	1927526	2/82	3991008	4/3
1916068	3/29	1917068	2/30	1926513	3/41	1927527	2/87	3991009	4/3
1916069	3/30	1917069	2/31	1926514	3/42	1927528	2/88	3991010	4/4
1916073	3/30	1917073	2/32	1926515	3/42	1927529	2/88	3991011	4/4
1916076	3/31	1917076	2/32	1926516	3/38	1927530	2/89	3991012	4/4
1916077	3/31	1917077	2/33	1926517	3/38	1927531	2/89	3991013	4/4

Artikel-Nr. <i>Article-no.</i>	Seite <i>Page</i>	Artikel-Nr. <i>Article-no.</i>	Seite <i>Page</i>	Artikel-Nr. <i>Article-no.</i>	Seite <i>Page</i>	Artikel-Nr. <i>Article-no.</i>	Seite <i>Page</i>	Artikel-Nr. <i>Article-no.</i>	Seite <i>Page</i>
3991014	4/4								
3991015	4/4								
3991016	4/4								
3991017	4/4								
3991022	4/5								
3991023	4/5								
3991024	4/5								
3991025	4/5								
3991026	4/5								
3991027	4/5								
3991028	4/5								
3991029	4/5								
3991030	4/5								
3991031	4/5								
3991032	4/5								
3991033	4/6								
3991034	4/6								
3991035	4/6								
3991036	4/6								
3991037	4/6								
3991213	4/11								
3991214	4/11								
3991220	4/11								
3991253	4/12								
3991255	4/12								
3991256	4/13								
3991257	4/12								
3991258	4/14								
3991259	4/14								
3991264	4/7								
3991265	4/7								
3991266	4/7								
3991267	4/7								
3991268	4/7								
3991269	4/7								
3991270	4/7								
3991271	4/7								
3991272	4/7								
3991273	4/7								
3991274	4/7								
3991275	4/8								
3991276	4/8								
3991277	4/8								
3991278	4/8								
3991279	4/8								

Artikel-Nr. <i>Article-no.</i>	Seite <i>Page</i>	Artikel-Nr. <i>Article-no.</i>	Seite <i>Page</i>	Artikel-Nr. <i>Article-no.</i>	Seite <i>Page</i>	Artikel-Nr. <i>Article-no.</i>	Seite <i>Page</i>	Artikel-Nr. <i>Article-no.</i>	Seite <i>Page</i>
186131	5/66	4070028	5/72	4070162	5/73	4910053	5/19	4930076	5/38
198057	5/66	4070029	5/72	4070163	5/73	4910055	5/20	4930077	5/38
4010003	5/14	4070030	5/36	4070164	5/73	4910056	5/20	4930084	5/38
4010015	5/14	4070036	5/67	4070165	5/73	4910074	5/21	4930085	5/38
4010016	5/15	4070040	5/72	4070169	5/72	4910076	5/21	4930086	5/38
4010017	5/15	4070041	5/72	4070170	5/72	4910082	5/21	4930089	5/39
4010018	5/16	4070042	5/73	4070175	5/72	4910086	5/21	4930090	5/39
4010047	5/16	4070043	5/72	4070176	5/72	4910089	5/22	4930098	5/39
4010066	5/17	4070044	5/72	4070177	5/73	4910091	5/22	4930099	5/39
4010067	5/16	4070045	5/72	4070178	5/73	4910094	5/22	4930100	5/39
4010090	5/17	4070046	5/72	4070179	5/73	4910095	5/23	4930101	5/40
4010117	5/20	4070047	5/72	4070180	5/76	4910096	5/23	4930111	5/40
4010131	5/23	4070048	5/72	4070221	5/76	4910097	5/23	4930112	5/40
4010132	5/23	4070049	5/72	4070222	5/76	4920021	5/25	4940077	5/40
4010235	5/14	4070050	5/72	4070223	5/76	4920022	5/26	4940079	5/34
4010236	5/15	4070051	5/72	4070224	5/76	4920023	5/26	4940143	5/40
4010237	5/15	4070052	5/73	4070225	5/72	4920024	5/26	4940144	5/41
4010238	5/16	4070053	5/73	4070226	5/75	4920025	5/26	4940148	5/41
4010243	5/14	4070054	5/73	4070227	5/75	4920026	5/27	4940149	5/41
4010369	5/17	4070055	5/73	4070228	5/75	4920027	5/27	4940150	5/42
4010556	5/23	4070056	5/73	4070229	5/73	4920028	5/27	4940151	5/42
4020006	5/25	4070057	5/73	4070230	5/75	4920029	5/27	4940152	5/42
4020049	5/34	4070058	5/73	4070231	5/72	4920030	5/28	4940155	5/43
4020621	5/25	4070059	5/72	4070232	5/74	4920031	5/28	4940158	5/43
4020622	5/25	4070060	5/72	4070233	5/74	4920032	5/28	4940161	5/43
4030019	5/34	4070061	5/73	4070234	5/74	4920033	5/28	4940164	5/44
4030031	5/34	4070062	5/72	4070240	5/78	4920034	5/29	4940170	5/44
4040026	5/35	4070063	5/73	4070242	5/79	4920035	5/29	4940171	5/44
4040027	5/35	4070066	5/73	4070243	5/79	4920036	5/29	4940473	5/45
4040028	5/35	4070067	5/73	4070244	5/77	4920037	5/29	4940482	5/45
4040029	5/35	4070070	5/73	4070245	5/77	4920038	5/30	4940485	5/45
4040030	5/36	4070071	5/73	4070246	5/77	4920039	5/30	4940506	5/45
4040086	5/36	4070080	5/72	4070247	5/77	4920040	5/30	4940538	5/46
4040088	5/36	4070081	5/72	4070248	5/77	4920044	5/30	4950005	5/47
4040610	5/35	4070082	5/72	4070249	5/77	4920047	5/30	4950006	5/47
4040807	5/46	4070083	5/72	4070443	5/73	4920060	5/31	4950007	5/47
4050587	5/47	4070084	5/72	4070448	5/68	4920100	5/31	4950008	5/48
4050591	5/47	4070085	5/72	4080446	5/70	4920101	5/31	4950009	5/48
4060056	5/58	4070086	5/72	4080447	5/70	4920102	5/31	4950010	5/48
4060411	5/54	4070087	5/72	4080448	5/70	4920103	5/32	4950011	5/48
4060413	5/54	4070088	5/72	4090001	5/70	4920110	5/32	4950012	5/48
4070000	5/66	4070089	5/78	4900188	5/70	4920117	5/32	4950013	5/49
4070002	5/66	4070090	5/78	4910004	5/14	4920118	5/32	4950014	5/49
4070008	5/66	4070091	5/78	4910026	5/17	4920119	5/33	4950015	5/49
4070009	5/66	4070092	5/78	4910027	5/18	4920120	5/33	4950016	5/49
4070010	5/67	4070093	5/78	4910028	5/18	4930048	5/36	4950021	5/49
4070011	5/67	4070094	5/78	4910040	5/20	4930049	5/36	4950057	5/50
4070012	5/67	4070095	5/78	4910041	5/20	4930050	5/37	4950058	5/50
4070013	5/67	4070096	5/78	4910042	5/18	4930051	5/37	4950059	5/50
4070017	5/67	4070097	5/78	4910043	5/19	4930052	5/37	4950060	5/50
4070025	5/72	4070110	5/73	4910044	5/19	4930053	5/37	4950061	5/50
4070026	5/72	4070115	5/73	4910045	5/19	4930067	5/37	4950062	5/51
4070027	5/72	4070161	5/72	4910052	5/19	4930068	5/37	4950063	5/51

Artikel-Nr. <i>Article-no.</i>	Seite <i>Page</i>	Artikel-Nr. <i>Article-no.</i>	Seite <i>Page</i>	Artikel-Nr. <i>Article-no.</i>	Seite <i>Page</i>	Artikel-Nr. <i>Article-no.</i>	Seite <i>Page</i>	Artikel-Nr. <i>Article-no.</i>	Seite <i>Page</i>
4950076	5/51	4960072	5/64						
4950077	5/51	4960201	5/65						
4950078	5/52	4970072	5/69						
4950079	5/52	4970073	5/68						
4950082	5/52	4970074	5/80						
4950328	5/52	4970077	5/68						
4950352	5/53	4970078	5/68						
4960002	5/54	4970079	5/68						
4960003	5/54	4970081	5/80						
4960004	5/55	4970082	5/80						
4960005	5/55	4970086	5/80						
4960006	5/55	4970087	5/80						
4960007	5/56	4980067	5/71						
4960008	5/56	4980084	5/71						
4960009	5/56	4980085	5/71						
4960010	5/56	4990002	5/24						
4960011	5/57	4990003	5/24						
4960012	5/57	4990009	5/24						
4960013	5/57								
4960014	5/57								
4960015	5/58								
4960016	5/58								
4960035	5/58								
4960037	5/58								
4960040	5/64								
4960041	5/64								
4960042	5/64								
4960043	5/64								
4960045	5/65								
4960046	5/65								
4960047	5/65								
4960048	5/65								
4960050	5/59								
4960052	5/59								
4960053	5/59								
4960054	5/59								
4960055	5/59								
4960056	5/60								
4960057	5/60								
4960058	5/60								
4960059	5/60								
4960060	5/61								
4960061	5/61								
4960062	5/61								
4960063	5/61								
4960064	5/62								
4960065	5/62								
4960066	5/62								
4960067	5/62								
4960068	5/63								
4960069	5/63								
4960070	5/63								
4960071	5/63								

Artikel-Nr. <i>Article-no.</i>	Seite <i>Page</i>	Artikel-Nr. <i>Article-no.</i>	Seite <i>Page</i>	Artikel-Nr. <i>Article-no.</i>	Seite <i>Page</i>	Artikel-Nr. <i>Article-no.</i>	Seite <i>Page</i>	Artikel-Nr. <i>Article-no.</i>	Seite <i>Page</i>
5010592	6/9	5060101	6/33	5910086	6/11				
5010624	6/6	5060102	6/33	5910087	6/11				
5030100	6/24	5060103	6/34	5910088	6/11				
5030101	6/24	5060104	6/34	5910089	6/12				
5030102	6/25	5060105	6/34	5910090	6/12				
5030103	6/25	5060107	6/34	5930001	6/23				
5040000	6/13	5060369	6/28	5930003	6/23				
5040003	6/13	5060422	6/31	5930005	6/23				
5040004	6/13	5060424	6/31	5930008	6/24				
5040005	6/13	5060425	6/31	5930010	6/24				
5040090	6/17	5060426	6/32	5930030	6/24				
5040101	6/17	5060428	6/28	5930031	6/24				
5040150	6/21	5060429	6/28	5940001	6/14				
5040151	6/21	5070000	6/36	5940005	6/15				
5040152	6/22	5070001	6/36	5940006	6/15				
5040166	6/22	5070002	6/36	5940007	6/15				
5040388	6/13	5070003	6/37	5940010	6/16				
5040407	6/13	5070004	6/37	5940013	6/16				
5040408	6/14	5070012	6/38	5940035	6/16				
5040417	6/14	5070015	6/38	5940049	6/16				
5050000	6/3	5070016	6/38	5940051	6/19				
5050297	6/3	5070024	6/38	5940053	6/19				
5050298	6/3	5070025	6/38	5940054	6/20				
5060001	6/26	5070043	6/39	5940060	6/20				
5060002	6/26	5070044	6/39	5940062	6/20				
5060003	6/26	5070224	6/36	5940069	6/21				
5060004	6/26	5070225	6/37	5940072	6/16				
5060012	6/26	5070226	6/37	5940101	6/18				
5060013	6/26	5070227	6/37	5940107	6/18				
5060014	6/27	5070229	6/39	5940110	6/19				
5060015	6/27	5370004	6/39	5940112	6/21				
5060016	6/27	5370005	6/39	5950001	6/3				
5060017	6/27	5910004	6/6	5950004	6/4				
5060020	6/28	5910006	6/6	5950010	6/4				
5060021	6/28	5910008	6/7	5950011	6/4				
5060024	6/29	5910009	6/7	5950016	6/4				
5060025	6/29	5910010	6/7	5950018	6/4				
5060031	6/29	5910011	6/7	5950019	6/5				
5060032	6/29	5910012	6/8	5950020	6/5				
5060051	6/30	5910013	6/8	5950021	6/5				
5060053	6/30	5910014	6/8	5960006	6/33				
5060055	6/30	5910016	6/8	5960007	6/29				
5060056	6/30	5910019	6/9	5960012	6/27				
5060060	6/30	5910020	6/9	5960013	6/27				
5060061	6/31	5910023	6/9	5960017	6/34				
5060070	6/32	5910024	6/9	5960018	6/34				
5060071	6/32	5910058	6/10	5960019	6/35				
5060073	6/32	5910059	6/10	5970002	6/36				
5060075	6/32	5910060	6/10	5970003	6/40				
5060076	6/32	5910074	6/10	5970004	6/40				
5060077	6/33	5910076	6/10	5970006	6/40				
5060080	6/33	5910077	6/11	5970007	6/41				
5060089	6/33	5910081	6/11	5970008	6/41				

1. Werkstoff, Maßtoleranzen

WICONA-Profile werden im Strangpressverfahren aus der Aluminium-Legierung EN AW-6060 T66 (AlMgSi_{0,5}F22) warm ausgehärtet nach DIN EN 573-3, DIN EN 573-4 und DIN EN 755-2 hergestellt. Diese Legierung ist sehr korrosionsbeständig, gut anodisierbar und von hoher Festigkeit. Die Technischen Lieferbedingungen und Maßtoleranzen sind in DIN EN 12020-1 und DIN EN 12020-2 festgelegt.

2. Auswahl der Profile, Zubehörteile und Beschläge

Die Auswahl von Profilen, Zubehör und Beschlägen erfolgt eigenverantwortlich durch den Verarbeiter, abhängig von den baulichen Gegebenheiten, den statischen Erfordernissen, den architektonischen Vorstellungen und den Kundenwünschen, sowie unter Beachtung unserer Verarbeitungsrichtlinien. Bei der Festlegung von Elementgrößen müssen zur Aufnahme von Wärmedehnungen und Bauwerksbewegungen Fugen in der Rahmenkonstruktion und gegebenenfalls auch im Bauanschluss vorgesehen werden. Die in unseren Unterlagen dargestellten Bauanschlüsse müssen vom Verarbeiter den jeweiligen baulichen Bedingungen angepasst werden.

Zu beachten sind unsere Angaben über zulässige Flügelgrößen, -gewichte und -formate sowie Normen, Hinweise und Vorschriften von Fachverbänden und behördliche Verordnungen.

3. Bestellung

Alle Artikel der Profilprogramme können bei den eingerichteten Verkaufsbüros von WICONA und bei unseren anderen Vertriebspartnern bestellt werden. Pressblanke Profile, Zubehörteile und Beschläge werden aus Lagervorrat geliefert. Zwischenverkauf bleibt vorbehalten.

Bis auf wenige Ausnahmen sind die Profile dieser Liste objektbezogen nach Terminvereinbarung auch oberflächenveredelt lieferbar. Die Verkaufsbedingungen sind der WICONA-Preisliste zu entnehmen.

Lieferlängen sind in den Datenblöcken und der Preisliste der Profile angegeben. Die dort angegebenen Außenabwicklungen enthalten bei Verbundprofilen die gesamte sichtbare Abwicklung ohne Dämmleisten.

4. Transport

WICONA-Profile werden werkseitig mit äußerster Sorgfalt behandelt um Korrosion und mechanische Beschädigungen beim Transport und in den WICONA-Lagern auszuschließen. Diesem Zweck dient die Portionsverpackung in PE-Folie, gegebenenfalls unter Anwendung von Schutzöl.

Der Transport erfolgt durch WICONA oder durch Vertragsspediteure ausschließlich auf Fahrzeugen mit gedeckter Ladefläche und unter Beachtung unserer Verpackungs-, Verlade- und Transportvorschriften. Damit ist die größtmögliche Sicherheit gegeben, dass WICONA-Profile unbeschädigt beim Empfänger ankommen.

Mit der Übergabe der Ware an einen Spediteur oder Frachtführer, spätestens jedoch mit verlassen des Lagers oder des Lieferwerks, geht die Gefahr auf den Käufer über. Wird beim Eingang der Ware festgestellt, dass Verpackungen nass oder beschädigt sind, so muss dies beim Fahrer reklamiert werden; die Beanstandung muss mit Gegenzeichnung des Fahrers auf dem Lieferschein vermerkt werden. Zusätzlich muss dies dem Lieferer innerhalb von 7 Tagen schriftlich mitgeteilt werden. Nicht transportbedingte Sachmängel müssen, soweit durch zumutbare Untersuchungen feststellbar, unverzüglich, spätestens 7 Tage nach Warenanlieferung schriftlich mitgeteilt werden. Bei der ersten Untersuchung nicht erkennbare Mängel sind unverzüglich nach Feststellung unter sofortiger Einstellung laufender Be- oder Verarbeitung schriftlich anzuzeigen. Schadensmeldungen, die diese Fristen überschreiten, können wir nicht anerkennen. Zum Abladen am besten geeignet ist ein Kran mit Traverse und zwei Gurten mit mindestens 80 mm Breite. Wird mit Stapler abgeladen und transportiert, so nur mit breiten, auf großen Abstand eingestellten Gabelzinken. Die Auslieferungsfahrer sind angewiesen, unsachgemäßes Abladen zu melden.

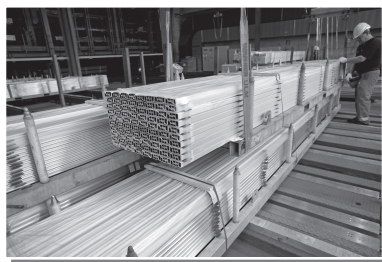

1. Material, Dimensional tolerances

WICONA profiles are manufactured in extrusion process from aluminium alloy EN AW-6060 T66 (AlMgSi_{0,5}F22) and age hardened according to DIN EN 573-3, DIN EN 573-4 and DIN EN 755-2. This alloy is highly corrosion-resistant, good for anodic treatment and is of high strength. The technical delivery terms and dimensional tolerances are predetermined in DIN EN 12020-1 and DIN EN 12020-2.

2. Selection of profiles, accessories and fittings

Selection of profiles, accessories and fittings is the fabricator's own responsibility, dependent on the structural conditions, the static requirements, the architectural conceptions and customer wishes whilst observing the guidelines of our Workshop Manual. Gaps in the frame construction and if necessary, also in the junctions to structure should be provided with regard to thermal expansions and structural movements when determining unit sizes. The junctions to structure, represented in our documents, must be adapted to the respective structural conditions by the fabricator.

Please follow our specifications concerning admissible sash/leaf sizes, weights and formats as well as standards, hints and instructions of professional associations and regulations of public authorities.

3. Ordering

All articles of our Profile Programme can be ordered from the established WICONA sales offices and other sales partners. Extruded profiles, accessories and fittings are delivered ex stock and are subject to prior (intermediate) sale.

Apart from few exceptions, the profiles included in this Programme List are also deliverable project based and surface treated according to the stipulated delivery time. Please refer to the current WICONA price list for sales conditions.

The delivery lengths are indicated in the data blocks and price list of profiles. The outer perimeter listed therein includes the total visible perimeter of composite profiles without the perimeter of thermal break strips.

4. Transport

WICONA profiles are treated with utmost care in the factory in order to prevent corrosion and avoid mechanical damages during transport and at the WICONA stocks. For this purpose, the profiles are bundled in portion packs in polyethylene foil and, when necessary, with application of a protective oil film.

The transport takes place through WICONA or contract forwarding agents, exclusively on vehicles with covered loading area considering our packaging, loading and transport prescriptions. This provides maximum safety for WICONA profiles to reach the addressee undamaged.

With the transfer of goods to a forwarding agent or freight carrier, the responsibility goes over to the purchaser, at the latest however on leaving the warehouse or supplying factory. If on receipt, the goods are found to be damaged or the packages are wet, complaint should be noted in the delivery receipt with countersignature of the driver. In addition, written notice should be sent to the supplier within 7 days. Quality defects other than transport damages, as far as identifiable through reasonable inspections, should be reported through written notice immediately, at the latest 7 days after delivery of goods. Not identifiable defects at the initial stage of inspection should be reported immediately by written notification after the identification while stopping the running processing. We cannot accept damage reports received after this time limit. A crane with traverse and two belts with minimum 80 mm width is best suited for unloading. If a fork lift truck is used for unloading and transport, then only with wide and widely spaced fork prongs. The truck drivers have instructions to report improper unloading procedures.

5. Lagerung beim Verarbeiter

Jede Einwirkung von Feuchtigkeit, auch durch Handschweiß oder durch Tauwasserbildung, kann bei pressblanken Aluminiumprofilen Korrosion auslösen. Auch eloxierte Oberflächen können durch alkalische Stoffe, z. B. Zement, Kalk, Mörtel oder durch Flugrost, Stahlspäne und dergleichen angegriffen werden. Wichtig ist daher eine trockene Lagerung in einem gedeckten Raum und die Vermeidung starker Temperaturschwankungen im Lager. Ein optimaler Schutz pressblanker Aluminiumprofile wird dadurch erreicht, dass sie erst unmittelbar vor der Weiterverarbeitung aus der werkseitigen PE-Folienverpackung entnommen werden. Eine starke Aufheizung der verpackten Profile durch direkte Sonneneinstrahlung muss vermieden werden.

Auflageflächen und seitliche Anlagen von Lagergestellen müssen aus nicht aggressivem Holz oder Kunststoff bestehen. Beim Entnehmen werden die Profile nur herausgehoben, keinesfalls aus dem Stapel herausgezogen. Bei jedem Handling von pressblanken Profilen sollten trockene, saubere Handschuhe getragen werden. Oberflächenbehandelte Profile sind gegen Korrosionsangriff durch Bewitterung und normale atmosphärische Einflüsse bestens und dauerhaft geschützt. Stoß-, Druck- und Biegebeanspruchungen können zu Beschädigungen von Eloxal und Beschichtung führen. Solche Schäden können in der Regel durch Nachbehandlung nicht beseitigt werden.

6. Verarbeitung

Genaue, vollständige und verbindliche Angaben zur Profilverarbeitung, Profilverbindung und zum Einbau von Beschlägen und Zubehör sind in unseren Verarbeitungsunterlagen enthalten.

Zur spanenden Bearbeitung von Aluminium sind Werkzeuge mit spezieller Schneidengeometrie über den Fachhandel lieferbar. Für saubere Schnitte ist das regelmäßige Nachschärfen der Werkzeuge und die Verwendung geeigneter Kühlschmiermittel wichtig. Für die wirtschaftliche Verarbeitung aller WICONA-Systeme bieten wir ein umfassendes Sortiment von Bearbeitungs- und Einbauschablonen, Montagehilfsmitteln, systembezogenen Spezialwerkzeugen, Stanzwerkzeugen und kompletten Stanzeinheiten an. Auch bei der Verarbeitung ist größte Sorgfalt geboten, um Schäden auf veredelten Oberflächen zu vermeiden. Eckverbindung mit Hülse: bei erhöhten optischen Anforderungen, oder sehr empfindlichen Sichtflächen, welche die in den Merkblättern VFF* Al.02 und VFF Al.03 dargestellten Mindestanforderungen unter Punkt "Fertigungsbedingte mechanische Beschädigungen" überschreiten, sollte an Stelle der vorgegebenen Hülse mit Bund (4070000), die Hülse ohne Bund (4070008) verwendet werden. Damit lassen sich bei Verbolzungsstellen, die sehr dicht an der Sichtfläche liegen, Abzeichnungen vermeiden.

Bei der Verwendung der Hülse ohne Bund (4070008) ist bei der Verarbeitung auf eine flächenbündige Setztiefe zu achten.

Spannbacken und Auflagen von Arbeitstischen sollten aus Holz oder Kunststoff bestehen und regelmäßig von darauf haftenden Spänen gereinigt werden; Stahlhämmer dürfen zur Profilverarbeitung nicht verwendet werden. Die meisten WICONA-Beschläge sind werkseitig gefettet; hingegen müssen Treibstangenkanäle, Drehkippscheren und Riegelschieber, Verriegelungsgarnituren und die zugänglichen beweglichen Teile von Fenstergetrieben, Handhebeln und Oberlichtöffnern beim Einbau leicht gefettet werden. Für die Reinigung fertiger Elemente liefert WICONA geeignete Mittel, die bei vorschriftsmäßiger Anwendung mit eloxierten bzw. beschichteten Oberflächen verträglich sind. Wir weisen besonders darauf hin, dass manche im Handel erhältlichen Produkte farbbeschichtete Oberflächen angreifen können.

5. Storage at the fabricator

Any influence of moisture, also through hand perspiration or formation of condensation water, can cause corrosion of extruded aluminium profiles. Even anodized surfaces can be attacked by alkaline substances, e.g. cement, lime, mortar or volatile rust, steel chips or similar. Hence, it is important to store profiles in a dry and covered room and avoid higher temperature fluctuations in the warehouse. Optimum protection of extruded aluminium profiles is achieved by unpacking from the factory packed Polyethylene foil just before further machining.

Strong heating through direct solar radiation of packaged profiles should be avoided.

The bearing surfaces and lateral supports of storage racks must be made of non-aggressive wood or plastic.

Only remove the profiles from the storage rack by lifting, never by pulling them out of stacks. Always wear dry and clean gloves whenever handling millfinished extruded profiles.

Surface treated profiles are well and durably protected against corrosive attacks through weathering and normal atmospheric influences. Impact, compressive and bending stress can lead to damages of anodized and coated surfaces of profiles.

Usually, such damages cannot be eliminated through after-treatment.

6. Processing

Our Workshop Manual provides precise, complete and binding specifications for processing and connecting profiles as well as for the assembly of fittings and accessories.

Tools with special cutting edge geometry for machining aluminium can be obtained from specialized dealers. Regular re-sharpening of tools and application of appropriate cooling lubricants is important for obtaining clean cuts. We offer a comprehensive range of processing and assembly templates, assembly auxiliary means, system specific special tools, punching tools and complete punching units for most efficient and economical processing of all WICONA systems.

The machining should also be done with utmost care to avoid damages on surface treated aluminium profiles. Corner junction with bush: for increased optical requirements or for very delicate visible surfaces which exceed the minimum requirements set out by the VFF* Al.02 and VFF Al.03 leaflets under point "Manufacturing-related mechanical damages", the bush without collar (4070008) should be used instead of the specified bush with collar (4070000). That way, for bolting areas which are very close to the visible surface of the profile, slight surface deformations can be avoided.

When using the bush without collar (4070008), it is important to pay attention during manufacture that the seating depth is flush with the surrounding profile area.

Clamping jaws and supports of work benches should be made of wood or plastic and must be cleaned regularly from chips adhering to them. Steel hammers should not be used for processing profiles. Most of WICONA fittings are delivered greased ex factory, however drive rod channels, turn/ tilt retainer arms, lock slide rod, locking sets and the accessible movable parts of window gears, hand levers and fanlight openers must be slightly greased while assembling.

WICONA provides appropriate cleaning agents for fabricated units which are compatible with the anodized and coated surfaces when used according to prescriptions. Particularly, we would like to point out that some products offered on the market could attack colour coated profile surfaces.



7. Oberflächenbeschaffenheit und -behandlung

Auf den Sichtflächen der pressblanken Aluminiumprofile sind nach EN 12020-1 leichte Riefen und andere leichte Aufrauungen, z.B. Scheuerstellen, zulässig. Inwieweit diese bei der nachfolgenden Oberflächenbehandlung beseitigt werden, hängt von der Art der Behandlung ab.

Die **Eloxalbehandlung** ist nach EN 12373 und den Bestimmungen der GÜTEGEMEINSCHAFT ANODISIERTES ALUMINIUM E.V. (GAA), bzw. den Bestimmungen für das Gütezeichen für anodisch erzeugte Oxidschichten auf Aluminium Halbzeug (Ausgabe Sept. 2004) der Qualanod-Zürich, CH-8027 Zürich oder vergleichbaren lokalen Vorschriften und Bestimmungen auszuführen.

Bei einer Vorbehandlung ohne wesentlichen Oberflächenabtrag nach E0 bleibt die durch Herstellung und Bearbeitung bedingte Oberflächenbeschaffenheit erhalten. Auch bei einer chemischen Vorbehandlung in Spezialbeizen nach E6 werden leichte Riefen und Aufrauungen nicht beseitigt, sondern höchstens ausgeglichen und bei beiden Vorbehandlungen können Korrosionserscheinungen, die in pressblankem Zustand nicht oder kaum wahrgenommen wurden, sichtbar werden. Gefügeunregelmäßigkeiten und Strangpressnähte können insbesondere bei E6 hervorgehoben werden. Bei höheren Ansprüchen an das dekorative Aussehen muss eine mechanische Vorbehandlung nach einem der in EN 12373 aufgeführten Verfahren E1...E5 vorgenommen werden.

Zulässige Abweichungen in Aussehen und Farbe müssen zwischen den Vertragspartnern vereinbart werden, am besten mit Hilfe von Grenzmustern. EN 12373 enthält Kriterien für die Beurteilung des dekorativen Oberflächenaussehens.

Die **Beschichtung** von Aluminiumprofilen ist nach den Güte- und Prüfbestimmungen der GSB INTERNATIONAL Gütegemeinschaft bzw. den Vorschriften zur Erlangung eines Gütezeichens für Beschichtungen auf Aluminium durch Nass- und Pulverlackierung bei Architekturanwendungen (Ausgabe 2003) der Qualicoat Gütegemeinschaft, Zürich, oder vergleichbaren lokalen Vorschriften und Bestimmungen auszuführen. Auch diese Richtlinien enthalten Angaben zur Beurteilung der Oberflächen. Bei Pulverlacken beträgt die Schichtdicke auf Sichtflächen bei Außenanwendung 50...120 µm.

Zu vermeiden sind örtliche Lackanhäufungen bei Einschub-, Schnapp-, Klips- oder Drehverbindungen oder in den Aufnahmen von Dichtungen. Derartige Profilverbindungen sind von uns auf die normalen Wanddickenveränderungen durch Oberflächenbehandlung ausgelegt; übermäßiger Lackauftrag kann Funktion und Verbindungsmöglichkeit beeinträchtigen. Schieberstangen sollten möglichst nur eloxiert werden; eine Beschichtung, falls unumgänglich, sollte auf eine Schichtdicke von 30 µm beschränkt werden. Der Verarbeiter muss dafür Sorge tragen, dass die in seinem Auftrag arbeitende Eloxal- bzw. Beschichtungsanstalt angelieferte pressblanken Profile mit erkennbaren Oberflächenschäden (auch Korrosion) oder mit starken Verwindungen nicht bearbeitet, wenn absehbar ist, dass diese Profile nach der Oberflächenbehandlung verworfen werden. WICONA übernimmt keine Kosten, die aus der Nichtbeachtung dieser Auflage entstehen.

8. Verhütung von Korrosions- und Oberflächenschäden am Bau

Aluminium kann beim Zusammenbau mit anderen metallischen Werkstoffen, ausgenommen rostfreier Stahl der Werkstoffgruppe 1.4301 (A2) und 1.4401 (A4) nach EN 10088-1, durch Bildung von Kontaktelementen angegriffen werden. Dies gilt besonders für die Verbindung mit Kupfer und Kupferlegierungen. Abhilfe ist möglich durch Vermeiden von direktem metallischem Kontakt, z.B. mittels geeigneten Schutzanstrichen oder Kunststoff-Zwischenlagen.

Ein optimaler Schutz von Aluminiumbauteilen während der Bauarbeiten wird durch Verwendung von Einputz-Zargen erreicht, in welche die Bauteile erst nach Abschluss der Maurer- und Putzarbeiten eingesetzt werden. Bei Anwendung anderer Schutzverfahren (Abzieh- oder Klarlacke, selbstklebende Kunststoff-Folien) ist ausschließlich der Anwender dafür verantwortlich, dass die verwendeten Produkte uneingeschränkt mit eloxierten oder farb-

7. Surface finish and treatment

Slight score marks and other slight roughness such as chafe marks on visible surfaces of extruded aluminium profiles are admissible according to EN 12020-1. The extent of removal of these defects depends on the kind of subsequent surface treatment.

The anodic treatment has to be performed according to the European Standard EN 12373 and the regulations of GÜTEGEMEINSCHAFT ANODISIERTES ALUMINIUM E. V. (GAA) (Association for quality mark of anodic oxide layer on semi finished aluminium, September 2004 Edition) of Qualanod-Zürich, CH-8027 Zürich, Switzerland or comparable local rules and regulations.

In case of a pretreatment without significant surface abrasion, the consistency of profile surface at the stage of extrusion and processing remains preserved even after the anodic treatment E0. Even after a chemical pretreatment of special pickling and anodic treatment of E6, the slight score marks and roughness are not eliminated but at the most counterbalanced and in both cases of pretreatment, the signs of corrosion, hardly perceived in extruded condition, may become visible. Structural irregularities and extrusion seams can be visible especially after the anodic treatment of E6. For higher requirements on decorative appearance, a mechanical pretreatment should be carried out according to one of the procedures of E1 up to E5 described in EN 12373. Admissible deviations in

appearance and colour must be stipulated between the contracting partners, preferably with the help of limiting samples. The European Standard EN 12373 includes criteria for evaluation of decorative appearance of the surface.

The coating of aluminium profiles has to be carried out according to quality and test regulations of GSB INTERNATIONAL (Quality association for coating of construction parts) and according to regulations for attainment of quality mark for wet and powder coatings on aluminium in architectural applications (Edition of 2003) of Qualicoat Gütegemeinschaft, Zürich or comparable local rules and regulations. Also these guidelines include specifications for evaluation of surfaces. The powder coat thickness for outer application is 50 up to 120 µm.

Local lacquer accumulation in areas of sliding, snapping, turning connections and in retaining grooves of gaskets should be avoided. Such profile fitting is designed for normal changes of profile wall thickness through surface treatment; excessive coating can impair the function and connecting possibility. As far as possible, slide rods should only be anodized. If a coating is unavoidable, then the coating thickness should be limited up to 30 µm. The processor should ensure that the anodizing or coating factory working for him do not process extruded profiles with visible surface damages (also corrosion) if it is predictable that these profiles cannot be used for fabrication after the surface treatment.

WICONA cannot be held responsible for resulting damages and costs.

8. Prevention of corrosion and surface damages of profiles at site

Aluminium can be attacked due to assembly with other metallic materials except stainless steel of material group 1.4301 (A2) and 1.4401 (A4) corresponding to EN 10088-1. Especially, this applies to connection with copper and copper alloys. Direct metallic contact can be avoided with the help of e.g. plastic inter layers or protective coating.

Optimum protection of aluminium construction parts is achieved during the construction works by using plastering frames, in which the structural components are mounted after the completion of masonry and plastering works. For application of other protection procedures (strip lacquer or clear lacquer, self-adhesive plastic foils) the user is solely responsible with regard to the absolute compatibility of used products with the anodized or colour coated aluminium structural parts. In order to obviate rights of recourse for damages caused by



beschichteten Aluminiumbauteilen verträglich sind. Um Regressansprüchen für von Dritten verursachte Schäden vorzubeugen, empfiehlt sich bei größeren Objekten die Zwischenabnahme von Bauabschnitten sofort nach deren Fertigstellung. Die üblichen Hinweisschilder, mit denen andere Gewerke zur sorgfältigen Behandlung von Aluminium-Bauteilen aufgefordert werden, reichen nicht aus, um den Verarbeiter von möglichen Schadenersatzansprüchen zu entlasten. Korrosionsschutz für Stahlteile, Anschlüsse und Verstärkungen nach DIN 55928.

Bei der Oberflächenbehandlung von WICONA-Verbundprofilen müssen die Hinweise im nachfolgenden Anhang beachtet werden.

9. Verglasung, Fugenabdichtung

Glasmaße werden mit den Formeln unserer Stücklisten-Beispiele bzw. mit den Angaben unserer sonstigen Planunterlagen errechnet. Die Verglasung erfolgt entsprechend DIN 18361, den Verklotzungsvorschriften des Glaserhandwerks und den Richtlinien der Isolierglas-Hersteller. Besonders zu beachten sind die Vorschriften hinsichtlich des Dampfdruckausgleichs (zugleich Entwässerung) aus freien Falzräumen. Alle WICONA-Systeme sind für die Verglasung zwischen Elastomer-Dichtprofilen eingerichtet. Diese bestehen bis auf wenige Ausnahmen aus EPDM nach DIN 7863; zur Erleichterung des Einbaus sind sie mit Gleitpolymer beschichtet. Die Zuordnung von Füllungsdicke (einschließlich Dickentoleranz), Glasleiste und Dichtungsprofil ist in den Auswahltabellen dieser Lagerliste dargestellt. Dichtungsprofile dürfen nicht unter Zug eingebaut werden, sondern sind bei rund umlaufenden Dichtungen in den Ecken zu stauchen und oben zu stoßen. Hilfswerkzeuge hierfür sind lieferbar. Vulkanisierte Dichtungsrahmen werden von den Rahmenecken ausgehend zur Feldmitte hin verlegt.

Andere Verglasungssysteme mit ein- oder beidseitiger Anwendung von Dichtstoffen setzen die Verwendung spezieller Glasleisten voraus.

Bei Füllungen aus Acrylglas (PMMA) und Polycarbonat (PC) kann im Kontakt mit unseren EPDM-Dichtungen die Gefahr von Spannungsrissen in diesen Platten nicht ausgeschlossen werden. Das Risiko der Unverträglichkeit liegt außerhalb unserer Kontrolle und ist vom Verarbeiter mit den Herstellern solcher Füllungen abzuklären.

Für die Abdichtung von Bauanschluss- und Konstruktionsfugen bieten wir in unserem Programm geeignete Dichtstoffe, bei denen Adhäsion und Verträglichkeit auch mit farbbeschichteten Aluminiumflächen gesichert sind. Die Verarbeitungsmerkmale und die Sicherheitsdatenblätter dieser Stoffe sind zu beachten. Bei anderweitig beschafften Dichtstoffen obliegt dem Verarbeiter die Verantwortung für deren Auswahl.

10. Reinigung von WICONA-Bauteilen

Außenwandelemente sind neben der Beanspruchung durch Sonne und Regen aggressiven Luftbestandteilen ausgesetzt und unterliegen damit unvermeidlich einer Verschmutzung. Diese beeinträchtigt nicht nur das Aussehen der Fassade, sondern stellt durch die ständige Einwirkung der Schmutzablagerungen auch ein Korrosionsrisiko dar. Die Bauteile müssen daher in Intervallen, die je nach Standort unterschiedlich sind, gereinigt werden.

Ausführliche Hinweise zur Reinigung von Aluminiumbauteilen sind in unserem WICONA-Bedienungs- und Wartungshandbuch, sowie im technischen Merkblatt:

A05 Reinigen von Aluminium im Bauwesen bei der Aluminium-Zentrale e. V., Am Bonnhof 5, 40474 Düsseldorf enthalten; diese stellt auch eine Liste geeigneter neutral reagierender Reinigungsmittel zur Verfügung. Speziell zur Reinigung von Fassadenobjekten verweisen wir auf die GÜTEGEMEINSCHAFT FÜR DIE REINIGUNG VON METALL-FASSADEN E.V. (GRM), deren Mitglieder eine RAL gütegesicherte Reinigung von Fassaden anbieten.

third party, it is recommended to have intermediate inspection of construction stages of major projects immediately after completion. The usual information signs for careful treatment of aluminium construction parts are not sufficient to relieve the processor from possible indemnity claims.

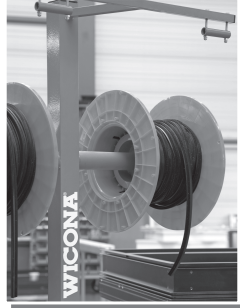

Corrosion protection for steel parts, junctions and reinforcements according to DIN 55928 (German Industrial Standard).

Indications in the following appendix should be observed for surface treatment of WICONA composite profiles.

9. Glazing, Joint sealing

Glass dimensions are calculated with the help of formulas of our material schedule examples and specifications in other planning documents. Glazing follows according to DIN 18361 and the shimming regulations of glazier trade and guidelines of insulation glass manufacturers. Pay attention especially to the regulations with regard to air pressure equalization (drainage at the same time) of open rebate areas. All WICONA systems are designed for glazing between Elastomer gasket profiles. Apart from few exceptions, these gaskets are made of EPDM according to DIN 7863 (German Industrial Standard). They are coated with Polymer (glide-polymerized) to facilitate assembly. The assignment of infill thickness (including thickness tolerance), glazing bead and gasket profile is shown in the selection tables of this profile programme catalogue. The gasket profiles should not be stretched during installation, but continuous gaskets must be compressed in the corners and butt-joined at the top. Auxiliary tools for this purpose are available. Vulcanized gasket frames are mounted starting from the frame corners to field centre. Other glazing systems with single or both sided use of sealants imply the use of specifically designed glazing beads.

The danger of tension cracks caused by contact with our EPDM gaskets while using infill plates made of acrylic glass (PMMA=Polymethyl methacrylate) and Polycarbonate (PC) cannot be ruled out.

The risk of incompatibility lies beyond our control and the fabricator should clarify this with manufacturers of such infills.

We offer in our programme suitable sealants for sealing junctions to structure and construction joints, ensuring adhesion and compatibility also with colour coated aluminium surfaces. The processing and security data leaflets of these sealants should be considered. The fabricator (processor) bears the responsibility for choice and procurement of sealants elsewhere.



10. Cleaning WICONA construction units

Besides stress from sun radiation and rain, the outer wall units are exposed to aggressive air constituents and thus soiling is unavoidable. This impairs not only the appearance of façade, but also constitutes the risk of corrosion through constant effect of dirt accumulations. Hence, the components must be cleaned at regular intervals, the length of which being dependent on the different locations and respective environmental loads.

Detailed indications for cleaning aluminium structural components are included in our WICONA operating and maintenance handbook and the technical leaflet:

A05 Cleaning of Aluminium in civil engineering available at the Aluminium-Zentrale e.V., Am Bonnhof 5, 40474 Düsseldorf. They also provide a list of appropriate and neutral cleaning agents. Especially for cleaning of façade projects, we refer you to the GÜTEGEMEINSCHAFT FÜR DIE REINIGUNG VON METALL-FASSADEN E.V. (GRM), whose members offer a RAL quality assured cleaning procedure of façades.

Wir beschränken uns nachfolgend auf einige wesentliche Hinweise:

- Leichte Verschmutzungen mit Wasser unter Zusatz eines neutralen Reinigungsmittels (keine Seifenlauge!) mit Schwamm und Tuch entfernen. Danach mit klarem Wasser gründlich spülen.
- Stärkere Verschmutzungen erfordern schwach abrasiv wirkende Reiniger, diese dürfen jedoch nicht auf Glas angewandt werden.
- Bei beschichteten Oberflächen sollte zuvor durch eine Probeanwendung auf einer verdecktliegenden Fläche sichergestellt werden, dass der Lack weder mechanisch noch chemisch angegriffen wird.
- Auszuschließen sind in jedem Fall Reinigungsmittel mit pH-Werten unter 5 oder über 8 sowie scheuernd oder schmirgelnd wirkende Mittel ebenso Stahlwolle oder Drahtbürsten.

11. Wartung von WICONA-Bauteilen

Sofern keine Funktionsstörungen oder durch unsachgemäßen Umgang verursachte Schäden vorliegen, kann die Wartung durch den privaten Hausbesitzer sich darauf beschränken, zugängliche gleitende Beschlagteile in größeren Zeitabständen leicht zu ölen oder zu fetten. Wartungsarbeiten bei größeren Objekten und bei öffentlichen Gebäuden gehören in die Hand des Fachmanns, zumal wenn sie mit weitergehenden Erhaltungsmaßnahmen verbunden sind.

Hier kann der Verarbeiter durch den Abschluss eines Wartungsvertrags mit der Bauherrschaft sicherstellen, dass die Qualität seiner Arbeit über einen langen Nutzungszeitraum zur Zufriedenheit seines Kunden erhalten bleibt.

12. Funktionsfähigkeit

WICONA-Fenster erfüllen die Anforderungen hinsichtlich der Fugendurchlässigkeit, (EN 12207), Schlagregendichtheit (EN 12208), Widerstandsfähigkeit bei Windlast (EN 12210) und den Richtlinien der Gütegemeinschaft Aluminiumfenster. Systemprüfberichte stehen zur Verfügung, ebenso Prüfzeugnisse über Sonderprüfungen bezüglich Schallschutz, Angriffshemmung und Rauchdichtigkeit bei Türen. Die Dichtungs- und Entwässerungssysteme der dargestellten Serien funktionieren in der Regel nur bei lotrechtem Einbau. Im Zweifelsfall bitten wir um Rückfrage.

WICONA-Fenster und -Fenstertüren entsprechen bei Kombination mit geeigneten Isoliergläsern, insbesondere Wärmeschutzgläsern den Anforderungen der Energieeinsparverordnung von 2009.

Über die Einstufung unserer wärmedämmten WICONA-Systeme nach EN ISO 10077-1(2) geben entsprechende Unterlagen Auskunft.

Mit dieser Einstufung und den von den Glasherstellern angegebenen U_g -Werten lassen sich die U_w -Rechenwerte für verglaste Fenster und Fenstertüren ermitteln.



13. Technische Service-Leistungen

Unsere Planungs- und Zeichnungsunterlagen, Verarbeitungsrichtlinien und Beschlagseinbaupläne erleichtern Ihnen die Verarbeitung unserer Systeme. Darüber hinaus stehen Ihnen die Beratungsdienste von WICONA und unseren Vertriebspartnern zur Verfügung. Unterlagen und Beratungen entsprechen unserem besten Wissen. Eine Gewähr für Fehlerfreiheit kann jedoch nicht übernommen werden, es sei denn, die Fehler beruhen auf Vorsatz oder grober Fahrlässigkeit unsererseits.

Unsere Verarbeiter bieten wir Schulungen vor Ort oder Seminare in unserem Technologie-Zentrum mit mehrtägiger intensiver Unterweisung in Theorie und Praxis des Metallbaus. Unser PC-Softwarepaket WICTOP/WICPLOT eröffnet die vielseitigen Möglichkeiten moderner Datenverarbeitung bei Angebotskalkulation, Arbeitsvorbereitung, Zuschnittoptimierung, Zeichnungserstellung bis hin zur Steuerung der Profilsäge. Auch auf diesem Gebiet werden unsere Verarbeiter in die Anwendung eingeführt. Durch aktuelle Infos halten wir unsere Kunden in Technik und Normung auf dem laufenden.

In the following, we confine ourselves to some essential hints:

- Remove slight soiling with water containing a neutral cleaning agent (no soapsuds!) using sponge and cloth, thereafter rinse thoroughly with clear water.
- Stronger soiling requires slightly abrasive acting cleaning agents which, however, should not be used on glass.
- For coated surfaces, we recommend to test the agents on a concealed surface to make sure that the agents do not attack lacquer either mechanically or chemically.
- By no means use cleaning agents with pH-values below 5 and above 8 as well as abrasive or sanding agents or steel wool and wire brushes.

11. Maintenance of WICONA structural components

As far as there are no malfunctions or damages caused by improper handlings, the maintenance by the private house owner can be restricted to slightly oiling or greasing accessible gliding fitting parts at larger intervals. Maintenance works on larger projects and public buildings should be carried out by professionals, especially when they are connected with further preservation measures.

In this case, the fabricator can assure the quality of his work over a long period of time and the satisfaction of his client by concluding a maintenance contract with the building owner.

12. Functional capability

WICONA windows fulfil the requirements with regard to air permeability (EN 12207), water tightness (EN 12208), resistance to wind load (EN 12210) and the guidelines of Gütegemeinschaft Aluminiumfenster (Association for quality mark of aluminium windows). System test reports are available, as well as test certificates for sound insulation, assault resistance and smoke tightness of doors. As a rule, the sealing and drainage systems of the represented series will work correctly only when installed vertically.

Please revert in case of doubt.

In combination with appropriate insulation glazing, especially heat protecting glass, WICONA windows and casement doors comply with the requirements of the energy saving ordinance 2009.

The classification of our thermally insulated WICONA systems according to EN ISO 10077-1(2) can be found in our documentation.

Based on this classification and the U_g -values supplied by the glass manufacturers, the U_w values for glazed windows and casementdoors can be calculated.

13. Technical service performances

Our planning documents and technical drawings, workshop manuals and fittings installation plans facilitate processing of our systems. Furthermore, the support services of WICONA and of our distribution partner are at your disposal. Our documents and services are provided to the best of our knowledge. However, we cannot assume liability for correctness except for errors based on intent or gross negligence on our part.

We offer trainings for our system fabricators on site or seminars of several days' intensive theoretical and practical instructions in metal construction at our Technology Centre. Our PC-Software packet WICTOP/WICPLOT offers a variety of possibilities of modern data processing for tender estimating, work scheduling, optimization of profile cutting, drafting and even control of profile saw. Our fabricators are also introduced into this field of application. We keep our customers updated with regard to the latest technique and standards through continuous informations.

14. Werksgarantie

Den Verarbeitern unserer wärmegeprägten Fenstersysteme bieten wir eine Garantie über die Einhaltung einer Reihe der in dieser Liste gemachten Angaben.

Die Garantieerklärung stellen wir dem Verarbeiter auf Anforderung gern zur Verfügung.

Wir weisen darauf hin, dass die Garantie erlischt, sofern andere als die im jeweils gültigen WICONA-Lieferprogramm aufgeführten Profile, Zubehörteile und Beschläge verwendet werden. Der gleiche Vorbehalt gilt als Haftungsausschluss sinngemäß auch für unsere nicht wärmegeprägten Systeme.

15. Warenzeichen WICONA

Verschiedene Profile und Konstruktionen des WICONA-Programms sind patentrechtlich geschützt.

In unseren Technischen WICONA-Unterlagen sind die Ergebnisse unserer Entwicklungsarbeit, unsere Erfahrungen und unser Fachwissen als Systemhersteller eingebracht. Die Wiedergabe des Inhalts dieser Liste wie auch des Inhalts unserer anderen Unterlagen ist deshalb nur mit unserer schriftlichen Genehmigung und unter Benutzung unseres Warenzeichens WICONA mit dem Hinweis gestattet:

® = eingetragenes Warenzeichen der Sapa Building Systems GmbH, Ulm.

Die Benutzung dieses Warenzeichens zu Werbezwecken oder als Produktbezeichnung ist nur zulässig, sofern ausschließlich Profile, Zubehörteile und Beschläge des jeweils gültigen WICONA-Lieferprogrammes vorgesehen oder verwendet worden sind. Wer also WICONA-Konstruktionsteile ganz oder teilweise mit fremden Konstruktionsteilen verarbeitet, ist nicht zur Benutzung unseres Warenzeichens berechtigt. Insbesondere dürfen mit fremden Konstruktionsteilen hergestellte Bauteile nicht gegenüber Architekten, Bauherren usw. als „WICONA-Fenster, -Türen“ oder ähnlich bezeichnet werden. Änderungen von Profilen, Zubehörteilen, Beschlägen und Konstruktionen bleiben vorbehalten. Angegebene DIN-Normen werden sinngemäß von den WICONA-Landesorganisationen in landesübliche Normen und Richtlinien übertragen.

16. Beschläge

Beschläge und vergleichbare Bauteile sind gemäß den zu erwartenden Belastungen und unseren Angaben dimensioniert und durch Nanosil-Qualität verstärkt gegen Korrosion geschützt (Schutzklasse 5 nach EN 1670:2007). Der Verarbeitungsbetrieb wählt nach zulässigen Beanspruchungen unsere Beschläge aus. Wartung beweglicher Beschlagteile gegen Verschleiß und Korrosionsanfälligkeit sowie Häufigkeit der Reinigung und Pflege sind entsprechend den Anforderungen mechanischer und chemischer Belastungen aus der Umgebung durchzuführen. Alle Abbildungen sind DIN R dargestellt.

Gütesicherung der Beschläge:

Notwendige Güteeigenschaften für

- Fenster und Fenstertüren nach RAL-RG 636/1 und RAL-RG 716/1 bewertet. Dauerfunktionstüchtigkeit, Korrosionsschutz, Leichtigkeit, Bedienbarkeit usw. von Dreh- Kipp-Beschlägen nach europäischer Norm EN 13126-8 beurteilt.
- Türen- und Spezial-Beschläge nach Anforderungen der VOB-Teil C, DIN 18357 und den jeweiligen EN-Prüfungen.

14. Factory guarantee

We offer the fabricators of our thermally insulated window systems a guarantee with regard to the compliance with the sequence of specifications made in this programme list.

This guarantee declaration is provided to fabricators on request.

We would like to point out that the guarantee becomes void if other profiles, accessory parts and fittings than the ones listed in the valid WICONA product range are used.

The same conditions also apply to our non thermally broken systems.

15. WICONA Trademark

Several profiles and constructions of the WICONA Programme are protected by patent rights.



Our technical WICONA documents include results of our development work, our experiences and our specialized knowledge as system producer. Hence, reproduction of contents of this list as well as contents of our other documents is only allowed

with our written permission and using our trade mark WICONA with the indication:

® = Registered trade mark of Sapa Building Systems GmbH, Ulm.

The use of this trade mark for advertising purposes or as product name is only admissible provided that profiles, accessories and fittings exclusively out of the respective, valid WICONA product range are used or intended to be used. Fabricators using WICONA components partially or exclusively in conjunction with foreign components is not entitled to use our trade mark. Particularly, structural components fabricated with external constructions parts should not be designated as „WICONA windows and doors“ or similar towards Architects, Building owners etc. We reserve the right to alter profiles, accessory parts, fittings and constructions. The specified DIN standards are transferred by the local WICONA organizations into local customary standards and guidelines.

16. Fittings

Fittings and comparable structural components are dimensioned according to the expected loads and our specifications and are highly protected against corrosion through Nanosil quality coating (protection class 5 to EN 1670:2007). The fabricating company selects our fittings according to the admissible loads. Maintenance of movable fitting parts against wear and corrosion as well as frequency of cleaning and maintenance should be performed depending on the requirements regarding mechanical stress and chemical attacks from the surroundings. All displayed pictures are DIN R.

Quality assurance of fittings:

Necessary qualitative properties for:

- windows and casement doors according to RAL*-RG 636/1 and RAL*-RG 716/1. Evaluation of long term functionality, corrosion protection, soffit test, operability etc. of turn/tilt fittings according to European Standard EN 13126-8.
- Doors and special fittings according to requirements of VOB (German construction contract procedures), Part C, DIN 18357 and the respective EN tests.

Für die Vielzahl von Tür-Beschlag-Einzelteilen gelten eine Reihe von Normen wie die RAL-RG 607/8-3 ausweist.

Geltende Regelwerke sind mit dem ÜZ (Übereinstimmungsnachweis) belegt. Genannte Normen in der Bauregelliste, wie DIN EN 1627 für einbruchhemmende Türen, bestimmen die Qualität der jeweiligen Bauprodukte. Für die Sicherheitstechnik wie Rauch- und Feuerschutzelemente gelten neben den Normen die aktuellen Zulassungen und Prüfberichte.

Oberflächenschutz der Beschläge:

- Teile aus rostfreiem Stahl nach EN 10088-1, ohne Oberflächen-Behandlung.
- Teile aus Stahl mit Spezialverfahren oder nach EN 1403 verzinkt, chromatiert und zusätzlich mit verstärktem Korrosionsschutz beschichtet.
- Nichteisenmetalle: Alle sichtbaren Teile nach vereinbartem Farbmuster eloxiert bzw. beschichtet.

Die Oberflächenschutz-Vorschriften der Gütegemeinschaften werden eingehalten.

Anhang: Oberflächenbehandlung bei WICONA-Verbundprofilen

Bei unseren wärmegeprägten Verbundprofilen erfolgt die Verbindung der Aluminiumprofilschalen durch glasfaserverstärkte Polyamideleisten. Der Werkstoff dieser Leisten und das Verbindungsverfahren erlauben eine nachträgliche Oberflächenbehandlung der Profile nach dem heutigen Stand der Technik entsprechenden Eloxal- und Beschichtungsverfahren unter Einhaltung bestimmter Bearbeitungsbedingungen.

1. Aufrüsten

Die Wärmedämmzone darf nicht auf Druck, Zug, Biegung oder Torsion beansprucht werden. Ein Durchhängen der Profile muss gegebenenfalls durch zusätzliche Unterstützung abgefangen werden. Die Kontaktierung beim Beschichten muss an beiden Profilschalen und an beiden Stabenden, also insgesamt vierfach, erfolgen.

2. Vorbehandlung

Die in der Praxis gebräuchlichen Vorbehandlungen beim Eloxieren nach EN 12373 bzw. das dem Farbbeschichten vorausgehende Chromatieren nach DIN EN 12487 schädigen unsere Verbundprofile nicht. Auf folgende Punkte weisen wir besonders hin:

- Überbeizen muss wegen seiner Auswirkungen auf den Verbund vermieden werden.
- Zwischen den einzelnen Behandlungsstufen muss gründlich gespült werden, um Korrosion durch Badrückstände in den Verbindungszonen und in den Profilhohlkammern auszuschließen.
- Die Objekttemperatur bei Haftwassertrocknung darf 100 °C nicht überschreiten.

3. Grenzbedingungen bei Pulverbeschichtung

Bei der Aushärtung darf die am Profil im Ofen zu messende Objekttemperatur 200 °C über 15 Minuten nicht überschreiten. Die Einhaltung dieser Bedingungen ist durch Aufzeichnungen regelmäßig zu dokumentieren.

Number of Standards included in RAL-RG 607/8-3 are valid for a variety of door fitting components.

The prevailing regulations are covered by ÜZ (conformity evidence mark). The Standards listed in the list of building rules, such as DIN EN 1627 for burglary resistant doors determine the quality of respective building products. For the safety technique such as smoke control and fire protection units, besides the standards, the current approvals and test reports are valid.

Surface protection of fittings:

- *Parts made of stainless steel according to EN 10088-1 without surface treatment.*
- *Parts made of steel with special procedure or galvanized, chromated and additionally corrosion protection coated according to EN 1403.*
- *Nonferrous metals:
All visible parts anodized or coated according to stipulated colour sample.*

The surface protection regulations of Association for quality mark are complied with.

**: German Institut for Quality Assurance and Certification*

Appendix: Surface treatment of WICONA composite profiles

The aluminium profile shells of our thermally insulated composite profiles are connected with glass fibre reinforced polyamide strips. The material of these strips and connecting procedure allow a subsequent surface treatment of profiles corresponding to the latest technologically developed procedures of anodizing and coating, complying with certain processing conditions.

1. Equipment

The thermal insulation zone should not be stressed by pressure, traction, deflection or torsion. When necessary, sagging of profiles must be intercepted by additional support. For coating, electrodes must be placed on both profile shells and on both profile bar ends, i.e. totally fourfold contacts.

2. Pretreatment

The customary pre-treatment for anodizing according to EN 12373 or the preceding chromating according to DIN EN 12487 for colour coating in the practice does not damage our composite profiles.

Refer particularly to the following points:

- *Due to its effect on composite zone, the over pickling should be avoided.*
- *Rinse thoroughly between individual treatment stages to avoid corrosion through bath residues in connecting zones and in profile hollow chambers.*
- *The object temperature during the drying period of adhered water should not exceed 100 °C.*

3. Marginal conditions for powder coating

The maximum hardening temperature of profile in the furnace should not exceed 200 °C during 15 minutes. Compliance with these conditions should be documented regularly through records.

4. Entlacken/Wiederbeschichten von Verbundprofilen

Auf Grund bisheriger Erfahrungen mit Polyamidleisten halten wir eine einmalige Entlackung und Wiederbeschichtung für möglich. Für Isolierleisten aus anderen speziellen Kunststoffen gilt diese Aussage nicht. Bei Isolierleisten aus speziellen Kunststoffen ist vor dem Entlacken die Verträglichkeit der Entlackungsmittel vom Entlackungsbetrieb zu prüfen. Die Verantwortung für eine ordnungsgemäße Entlackung und Wiederbeschichtung liegt ausschließlich beim Entlackungsbetrieb. Sie sollte sich jedoch auf Ausnahmefälle beschränken.

Folgendes ist dabei zu beachten:

Zum Entlacken dürfen nur solche Chemikalien verwendet werden, die nachweislich Polyamid nicht angreifen. Mittel, die z.B. Ameisensäure enthalten, sind daher auszuschließen. Tragglieder nach DIN 18056 (Rahmen, Riegel, Pfosten) sollten nicht wieder beschichtet werden. Vor dem erneuten Beschichten muss das Verbundprofil mindestens 24 Stunden bei Raumtemperatur zwischengelagert werden. Unsere WICONA-Werksgarantie gilt nicht für solchermaßen mehrmals oberflächenbehandelte Profile.

4. Stripping and re coating composite profiles

Based on our past experiences with polyamide strip, we consider the possibility of stripping and re-coating only once. This predication does not apply to thermal break strips made of other special plastic materials. The compatibility for lacquer stripping agents should be checked by the stripping company for insulation strips made of special plastic prior to stripping lacquer. The stripping company is wholly responsible for proper stripping and re-coating.

However, it should be limited to exceptional cases.

Thereby, following has to be considered:

Only approved chemicals which do demonstrably not attack polyamide should be used for stripping. Agents containing formic acid for instance should not be used. Load bearing elements (frame, transom, mullion profiles) according to DIN 18056 should not be re-coated again. The stripped composite profile must be stored at room temperature for at least 24 hours prior to re-coating.



Our WICONA factory guarantee is not valid for profile surface treated several times in such a way.

Werkstoff-Kenndaten / Material data specifications







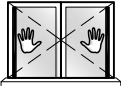
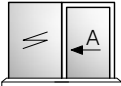
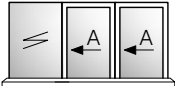
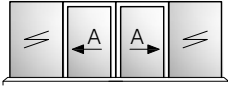
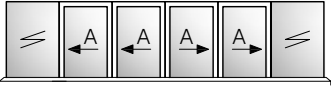



Aluminium EN AW-6060 T66 (AlMgSi0,5 F22)
DIN EN 573, DIN EN 755

Dichte / Density	ρ	2,7 g/cm ³	(2700 kg/m ³)
Zugfestigkeit / Tensile strength	R_m	21,5 kN/cm ²	(215 MPa)
Mindeststreckgrenze / Minimum yield strength	R_e	16,0 kN/cm ²	(160 MPa)
Längenausdehnungskoeffizient / Linear expansion coefficient	α	23,5 x10 ⁻⁶ /K	
E-Modul / Modulus of elasticity	E	7000 kN/cm ²	(70000 MPa)
Wärmeleitfähigkeit / Thermal conductivity	λ	160 W/mK	
- σ : im Lastfall H / for load combination H DIN 4113-1/A1		8,8 kN/cm ²	(88 MPa)
- σ : im Lastfall HZ / for load combination HZ		10,0 kN/cm ²	(100 MPa)
- τ : im Lastfall H / for load combination H		5,0 kN/cm ²	(50 MPa)
- τ : im Lastfall HZ / for load combination HZ		5,8 kN/cm ²	(58 MPa)

















Ansicht von Innen <i>Inner view</i>	Bezeichnung <i>Designation</i>	Ansicht von Außen <i>Outer view</i>	Ansicht von Innen <i>Inner view</i>	Bezeichnung <i>Designation</i>	Ansicht von Außen <i>Outer view</i>
	Anschlagtür, einflügelig oder Dreh - Fenstertür • einwärts <i>Hinged door, single leaf or window door</i> • inwards			Anschlagtür, zweiflügelig • einwärts <i>Hinged door, double leaf</i> • inwards	
	Anschlagtür, einflügelig • auswärts <i>Hinged door, single leaf or</i> • outwards			Anschlagtür, zweiflügelig • auswärts <i>Hinged door, double leaf</i> • outwards	
	Anschlagtür mit scheibentrennenden Sprossen • einwärts <i>Single leaf hinged door with glass partitioning glazing bars</i> • inwards			Gegentaktür <i>Push-pull door</i>	
	Pendeltür, einflügelig <i>Double action door, single leaf</i>			Pendeltür, zweiflügelig <i>Double action door, double leaf</i>	
	Anschlagtür, einflügelig mit Oberlicht Festelement • einwärts <i>Single leaf hinged door with fixed window fanlight</i> • inwards			Anschlagtür mit Festelement • einwärts <i>Hinged door with fixed glazing</i> • inwards	
	Anschlagtür, einflügelig mit Oberlicht Festelement • auswärts <i>Single leaf hinged door with fixed window fanlight</i> • outwards			Anschlagtür mit Festelement • auswärts <i>Hinged door with fixed glazing</i> • outwards	
	Anschlagtür, einflügelig mit Oberlicht Kippflügel • einwärts <i>Single leaf hinged door with tilt window fanlight</i> • inwards			Anschlagtür mit Festelement und Drehkipp Fenster • auswärts <i>Hinged door with fixed glazing and turn/tilt window</i> • outwards	
	Anschlagtür, einflügelig mit Oberlicht Kippflügel • auswärts <i>Single leaf hinged door with tilt window fanlight</i> • outwards			Anschlagtür mit Festelement und Oberlicht Festelement • einwärts <i>Hinged door with fixed glazing and fixed window fanlight</i> • inwards	
				Anschlagtür mit Festelement und Oberlicht Festelement • auswärts <i>Hinged door with fixed glazing and fixed window fanlight</i> • outwards	

Ansicht von Innen <i>Inner view</i>	Bezeichnung <i>Designation</i>	Ansicht von Außen <i>Outer view</i>	Ansicht von Innen <i>Inner view</i>	Bezeichnung <i>Designation</i>	Ansicht von Außen <i>Outer view</i>
	Fingerschutztür, einflügelig einwärts <i>Finger protection door, single leaf inwards</i>			Fingerschutztür, zweiflügelig einwärts <i>Finger protection door, double leaf inwards</i>	
	Automatische Schiebetüren, einflügelig <i>Automatic sliding doors, single leaf</i>			Automatische Schiebetüren, zweiflügelig <i>Automatic sliding doors, double leaf</i>	
	Automatische Schiebetüren, einflügelig <i>Automatic sliding doors, single leaf</i>			Automatische Schiebetüren, zweiflügelig <i>Automatic sliding doors, double leaf</i>	

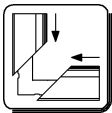

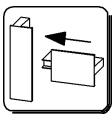

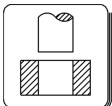

Zulässige Flügelgrößen
Admissible sash sizes

Symbol Symbols	Bezeichnung Designation		Hinweis Indication
	Windlast DIN EN 12210 Wind load	SF	Standflügel Inactive leaf
	Schlagregendichtheit DIN EN 12208 Watertightness	GF	Gehflügel Active leaf
	Einbruchhemmung RC1N/RC2N/RC2 DIN EN 1627:2011 Burglary resistance class RC1N/RC2N/RC2	DM	Dornmaß (mm) Backset (mm)
	Einbruchhemmung RC3 DIN EN 1627:2011 Burglary resistance class RC3	PZ	Profilzylinder Profile cylinder
	Durchschusshemmung DIN EN 1522 Bullet resistance	RZ	Rundzylinder Round cylinder
	Maximal zulässiges Flügelgewicht Maximum admissible leaf weight	H	Höhe (mm) Height (mm)
	1000 Pa = 1 kN/m ² 1000 Pa = 1 kN/m ²	L	Länge (mm) Length (mm)
	Notausgangsverschlüsse DIN EN 179 Emergency exit locks		Der Zuschnitt von Fluchttüren mit FAB _{min} muss mit Minustoleranz erfolgen! The cutting of escape doors with FAB _{min} must be in negative tolerance!
	Panikverschlüsse DIN EN 1125 Panic door locks		

Profilseiten
Profile pages

Symbol Symbols	Bezeichnung Designation	Symbol Symbols	Bezeichnung Designation
	Profil-Außenschale <i>Profile outer shell</i>		Eckwinkel <i>Corner angle</i>
	Profil-Innenschale <i>Profile inner shell</i>		Hülse <i>Bush</i>
	Profilstablänge <i>Profile bar length</i>		Stoßverbinder <i>Butt-joint connector</i>
	Äußerer Umfang Eloxal, ohne Wärmedämmleisten <i>External perimeter Anodic, without thermal insulation strips</i>		Leitteil <i>Guide part</i>
	Mechanisch bearbeitbare Fläche <i>Mechanically processible surface</i>		Bohrschablone <i>Drilling template</i>
	Eckverbindung <i>Corner connection</i>		Handstanzwerkzeug <i>Hand punching tool</i>
	Stoßverbindung (Blendrahmen/ Kämpfer, Kämpfer/Kämpfer) <i>Butt-joint connection (Frame/Transom, Transom/Transom)</i>		Multifunktionsstanzwerkzeug <i>Multi-function punching tool</i>
	Stanzen <i>Punching</i>		Presstawerkzeugsatz <i>Crimping tool set</i>

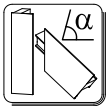
Profilseiten
Profile pages

Symbol Symbols	Bezeichnung Designation	Symbol Symbols	Bezeichnung Designation
	Selbstzuschnitt <i>Self-cut</i>		Gelenkeckwinkel, vertikal <i>Hinged corner angle, vertical</i>
	Presstaverbindung <i>Crimped connection</i>		Stift <i>Pin</i>
	Al-Strangpresseckwinkel <i>Extr. aluminium corner angle</i>		Kegelschraube <i>Conical screw</i>
	Breite Selbstzuschnitt <i>Width self-cut</i>		Gelenkeckwinkel, horizontal <i>Hinged corner angle, horizontal</i>
	Gelenkeckverbindung <i>Hinged corner connection</i>		Gelenkverbindung <i>Hinged connection</i>
	Bohren <i>Drilling</i>		Gelenkverbinder Außenschale <i>Hinged connector outer shell</i>
			Gelenkverbinder Innenschale <i>Hinged connector inner shell</i>
	Hauptsichtfläche <i>Main visible surface</i>		Nebensichtfläche <i>Secondary visible surface</i>

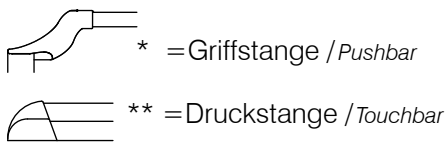
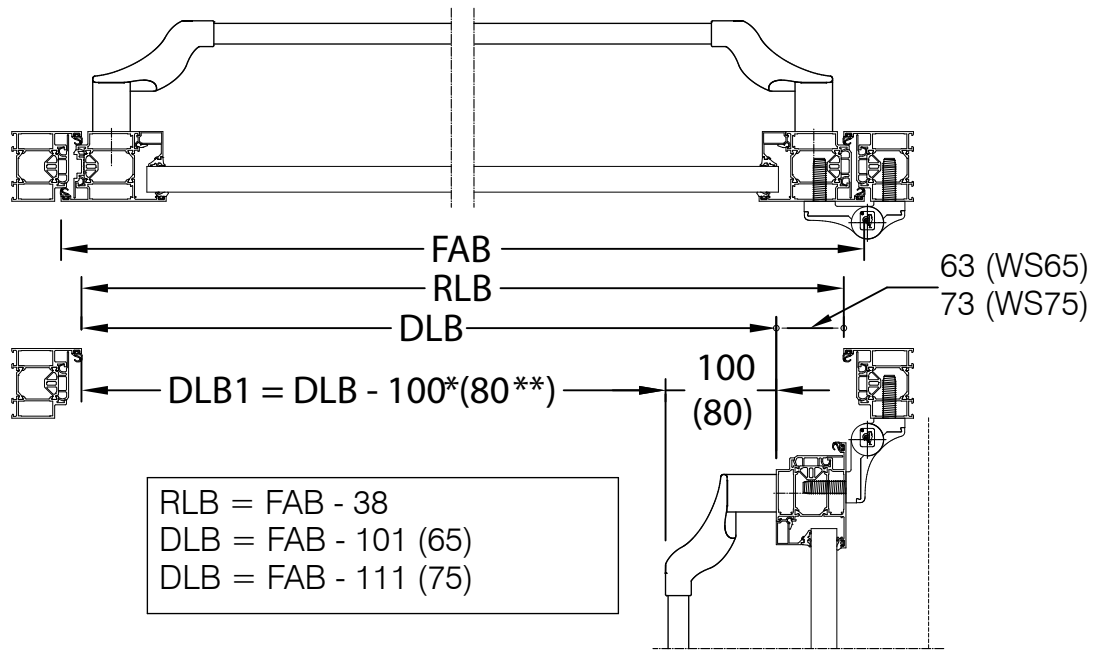

Laibung beachten
Mind soffit

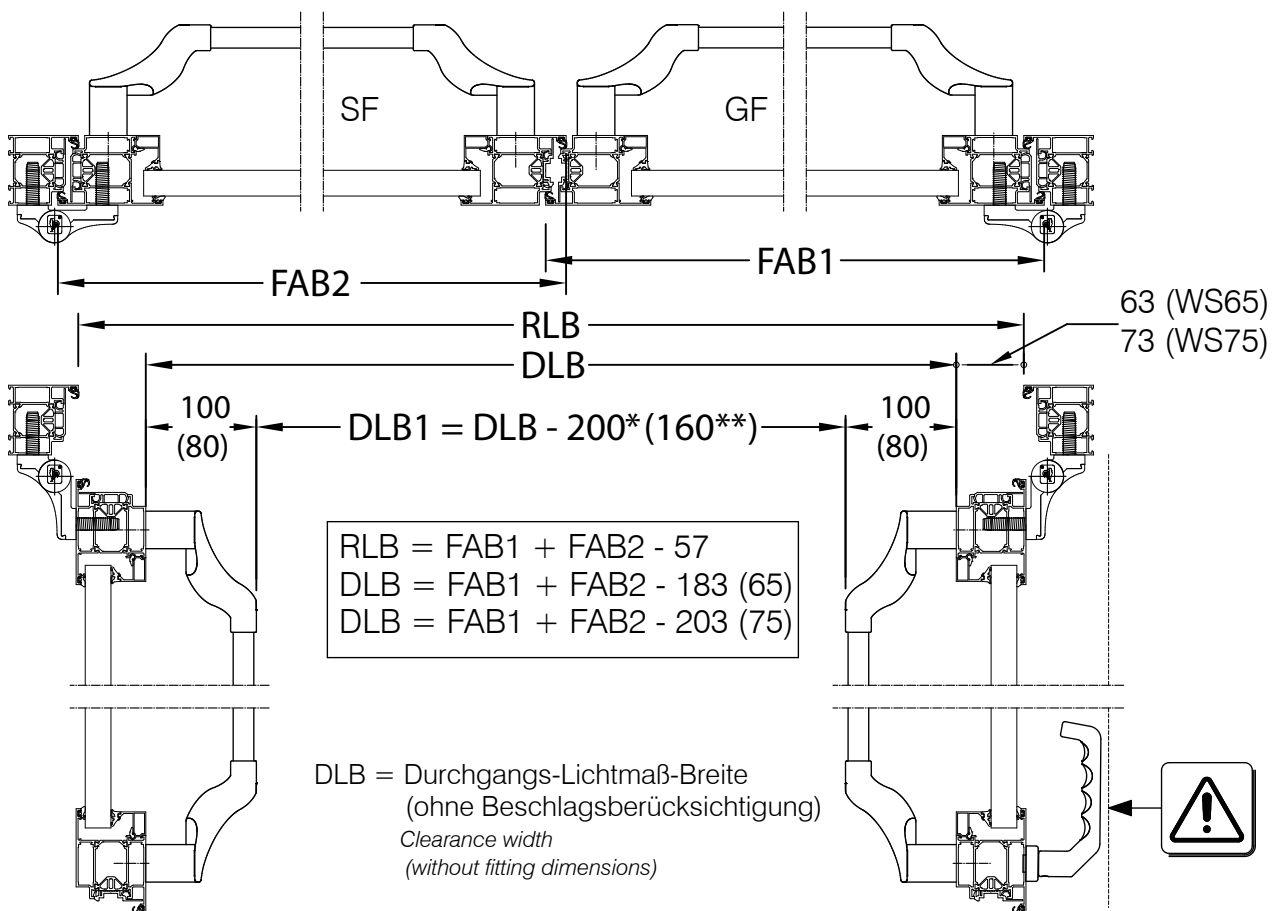

Laibung beachten
Mind soffit

WICSTYLE

Abkürzungsverzeichnis

List of abbreviations

Technische Information

Technical Information

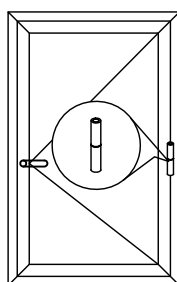
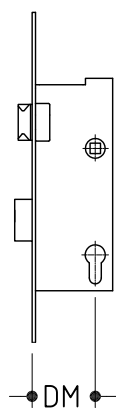
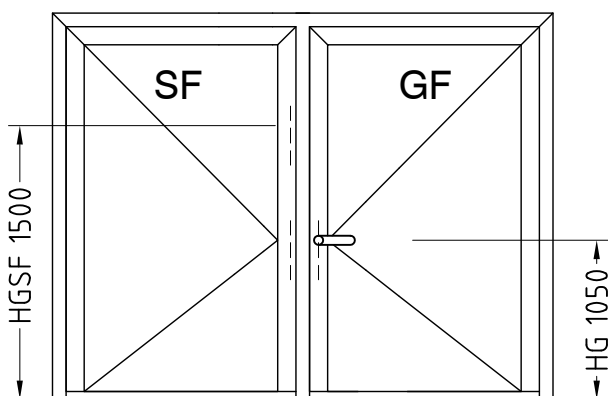
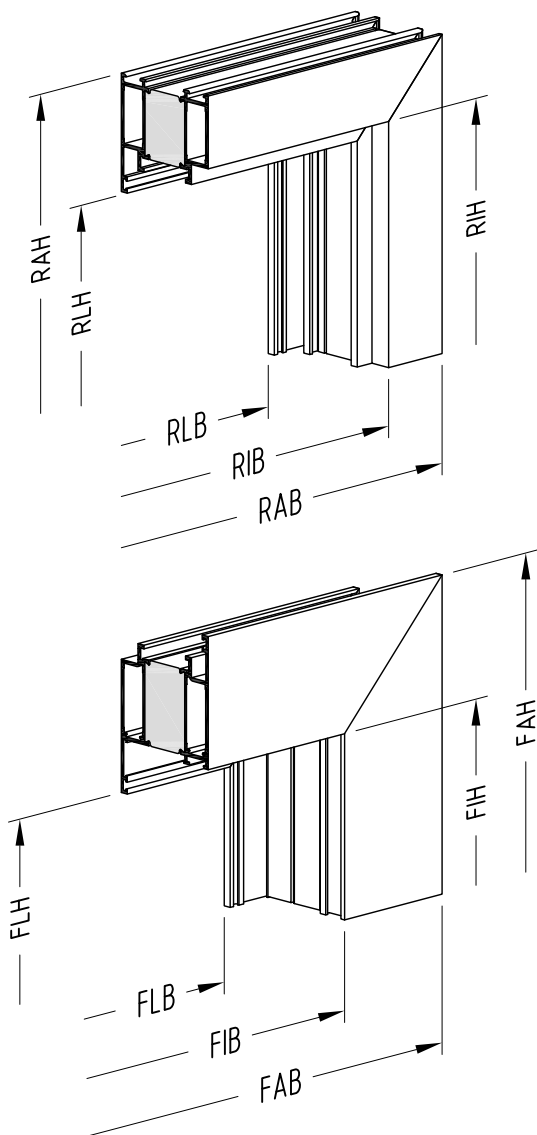

- RAB** Rahmen - Außenmaß - Breite
Frame outer width dimension
- RIB** Rahmen - Innenmaß - Breite
Frame inner width dimension
- RLB** Rahmen - Lichtmaß - Breite
Frame width clearance dimension
- RAH** Rahmen - Außenmaß - Höhe
Frame outer height dimension
- RIH** Rahmen - Innenmaß - Höhe
Frame inner height dimension
- RLH** Rahmen - Lichtmaß - Höhe
Frame height clearance dimension
- DLB** Durchgangs - Lichtmaß - Breite
Clearance width dimension
- FAB** Flügel - Außenmaß - Breite
Sash outer width dimension
- FIB** Flügel - Innenmaß - Breite
Sash inner width dimension
- FLB** Flügel - Lichtmaß - Breite
Sash width clearance dimension
- FAH** Flügel - Außenmaß - Höhe
Sash outer height dimension
- FIH** Flügel - Innenmaß - Höhe
Sash inner height dimension
- FLH** Flügel - Lichtmaß - Höhe
Sash height clearance dimension
- DM** Dornmaß
Backset dimension
- GF** Gehflügel
Active leaf
- SF** Standflügel
Inactive leaf
- HG** Höhe Griff
Height of handle
- HGSF** Höhe Griff Standflügel
Inactive leaf handle height
- OKFF** Oberkante Fertigfußboden
Top edge of finished floor
- MB** Mittelband
Centre hinge
- BS** Bandsicherung
Hinged sided interlock
- FR** Falzluftreduzierung
Rebate clearance reduction
- OK** Oberkante
Top edge

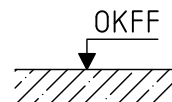

Rahmen - Eckverbindungstechnik

Frame corner connecting technique

Al-Gusseckwinkel / Cast aluminium corner angle

- Verbindung mit Schlaghülsen / Connection with drive bush
- Verbindung mit Kegelschrauben / Connection with conical screw
- Presstaverbindung / Crimped connection

Injektionsmethode / Injection method

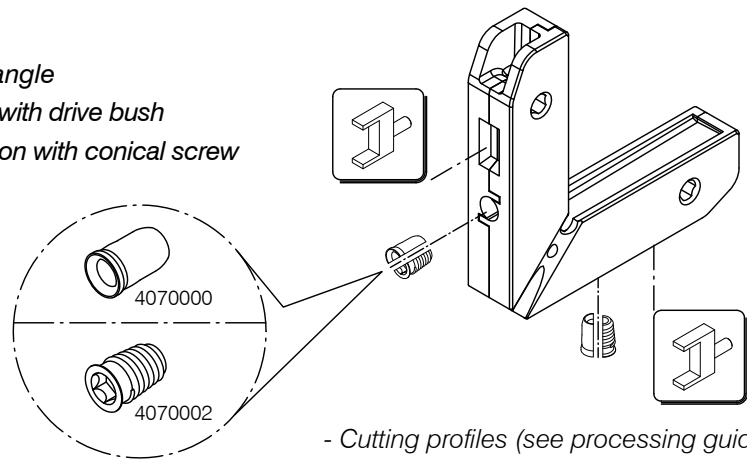

- Cutting profiles (see processing guidelines / processing means)

- Drill boreholes from outside for drive bushes (see Programme List / WICPRO for drill templates)

or

- Punching (see Programme List / WICPRO for punching tool)

- Clean processing areas dust and grease free with appropriate cleaning agents
 - Blow off profiles with compressed air
 - Consider instructions of adhesive manufacturers

Glue compact mitre cut surface

Join profiles according to construction point (see next page and profile pages in the Programme List)

- Crimped connection

or

- Connection with drive bush / conical screw

Glue injection through
 - drive bush
 or
 - injection holes

Remove glue residue with appropriate cleaner

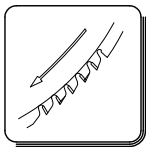

- Zuschnitt Profile (siehe Verarbeitungsrichtlinien / Bearbeitungsmittel)

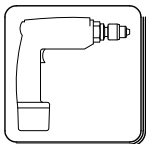

Hülsenbohrungen von außen einbringen durch
 - Bohren (Schablone siehe Programm / WICPRO)
 oder

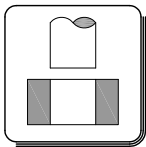

- Stanzen (Stanzwerkzeug siehe Programm / WICPRO)

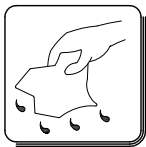

- Bearbeitungsstellen mit geeignetem Reinigungsmittel staub- u. fettfrei reinigen
 - Profile mit Druckluft abblasen
 - Angaben des Klebstoffherstellers beachten

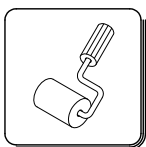

Gehungsschnittfläche dichtend kleben

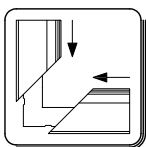

Zusammenfügen der Profile gemäß Konstruktionspunkt (siehe nächste Seite und Programm / Profilsseiten)
 - Pressta Verbindung
 oder
 - Bolzen- / Kegelschraubenverbindung

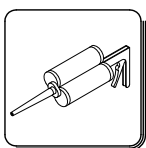

Klebstoffinjektion durch
 - Hülsen
 oder
 - Injektionsbohrungen

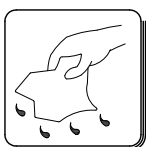
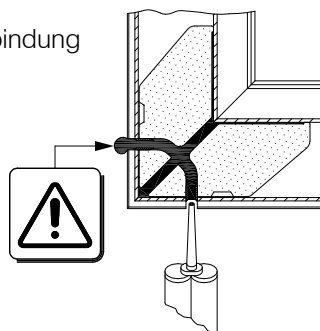

Klebstoffreste mit geeignetem Reiniger entfernen

	Seite Page
Serienbeschreibung <i>Description of series</i>	2/3
Profilübersicht <i>Survey of profiles</i>	2/8
Blendrahmenprofile <i>Frame profiles</i>	2/21
Sockelprofile <i>Bottom rail profiles</i>	2/43
Flügelprofile <i>Sash profiles</i>	2/47
Kämpfer, Sprossenprofile <i>Tansom, glazing bar profiles</i>	2/57
Stützenprofile <i>Mullion profiles</i>	2/66
Kupplungsprofile <i>Coupling profiles</i>	2/81
Schwellenprofile <i>Threshold profiles</i>	2/82
Aufsatzprofile <i>Supplementary profiles</i>	2/83
Anwendungsbeispiele <i>Examples of application</i>	2/91
Glasleistenprofile, Auswahltabellen <i>Glazing bead profiles, selection tables</i>	2/130
Zulässige Flügelgrößen <i>Admissible sash sizes</i>	2/133

WICSTYLE 75 ist eine wärmegeämmte Fensterserie mit 75 mm Profilbautiefe.

Öffnungsarten:

Mit Spezialblendrahmen:

- Ein- und zweiflügelige Anschlagtüren, nach innen und nach außen öffnend
- Mittelstoß bei zweiflügeligen Türen wahlweise mit oder ohne Aufsatzprofil

Kombinationselemente mit WICLINE 75:

- Ein- und zweiflügelige Anschlagtüren, nach innen und nach außen öffnend
- Gegentakttüren
- Fingerschutztüren
- Mit Oberlicht-Kippflügeln der Serie WICLINE 75
- Feste und bewegliche Seitenteile je nach Funktionsbedarf und Beschlägeanwendung

Profilbautiefen:

- 75 mm: Blendrahmen-, Kämpferprofile und flächenbündige Tür-Flügel-Profile, Klassik-Design mit Zusatzprofilen.
- 85 mm: Fenster-Überschlagflügelprofile im Oberlicht.

Profiltechnik:

- Hauptprofile im Dreikammersystem.
- Profil-Wärmeverbund kraft- und formschlüssig, qualitätsgesichert im Presswerk hergestellt.
- Außenansichtsbreiten:
 - Blendrahmenprofile von 48 mm bis 75 mm
 - Kämpferprofile von 73 mm bis 290 mm
 - Sockelprofile 107 mm bis 147 mm
 - Tür-Flügelprofile, einwärts 73 mm, 83 mm und 98 mm
 - Tür-Flügelprofile, auswärts 98 mm, 108 mm und 123 mm
- Türflügel wahlweise mit umlaufendem Flügelprofil oder mit unterem Sockelprofil
- Wetterschenkel flächenbündig
- Türschwelleprofile in Aluminium, thermisch getrennt mit Dichtungsanschlag
- Schwellenvarianten ohne thermische Trennung für Absenkungen vorhanden
- Türflügelprofile für flügelüberdeckende Füllungen
- Stützenprofile nach innen und außen verstärkt.
- Dehnprofile für vertikalen Elementstoß, Standard und verstärkt.
- Scheibentrennende Sprossen als Verbundprofil.
- Die Glasanschlüsse der Türflügel- bzw. Rahmenprofile werden mit 30° abgeschrägten Zusatzprofilen auf Klassik-Design-Charakter umgerüstet.
- Zusatzprofile für Profilkombinationen, Verglasungen und Bauanschlüsse.

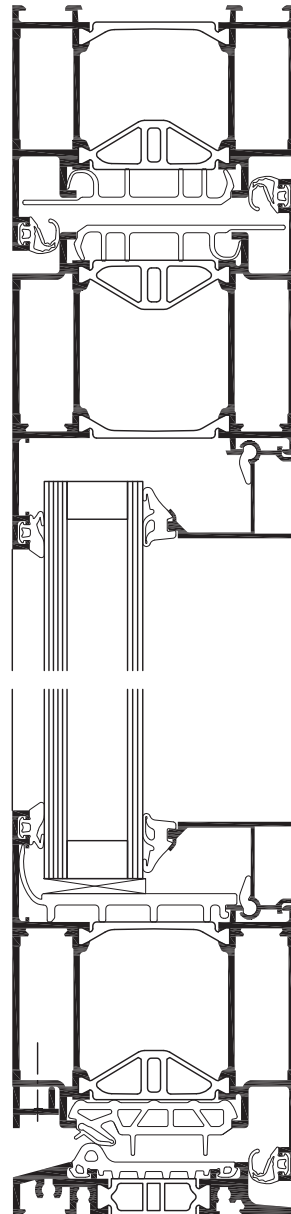

Anschlagtür, einwärts mit Spezialblendrahmen und Flügelprofil umlaufend

Hinged door with special frame and all-around leaf profile, inwards

WICSTYLE 75 is a thermally insulated door series with 75 mm construction depth.

Opening types:

With special frame profile:

- Single and double leaf hinged doors, inwards and outwards
- Meeting stiles of double leaf doors optionally with or without supplementary profiles

Combination units with WICLINE 75:

- Single and double leaf hinged doors, inwards and outwards
- Push-pull doors
- Finger protection doors
- With fanlight tilt sashes of WICLINE 75 series
- Fixed and movable lateral parts according to functional requirement and fittings application

Profile construction depths:

- 75 mm: Frame and transom profiles, flush fitting door leaf profiles. Renovation with supplementary profiles.
- 85 mm: Overlapping window sash profiles in fanlight.

Profile technique:

- Main profiles in three chamber system.
- Shape and force locking thermal compound profiles, quality-assured manufacture at the extrusion plant.
- Outer sight lines:
 - Frame profiles from 48 mm up to 75 mm
 - Transom profiles from 73 mm up to 290 mm
 - Bottom rail profiles 107 mm up to 147 mm
 - Inward opening door leaf profiles 73 mm, 83 mm and 98 mm
 - Outward opening door leaf profiles 98 mm, 108 mm and 123 mm
- Optionally, circumferential (all-around) door leaf profiles or with bottom rail profile
- Flush fitting weather bar profile
- Thermally insulated aluminium threshold profiles with gasket stop
- Optionally threshold variants without thermal break for lowering gaskets
- Door leaf profiles for leaf overlapping infills
- Internally and externally reinforced mullion profiles.
- Standard and reinforced expansion joint profiles for vertical unit joint.
- Glass partitioning composite glazing bar profiles.
- The outer stop web of frame and leaf glazing rebates can be changed over to Classic design characteristics with 30° bevelled supplementary profile.
- Supplementary profiles for profile combinations, glazings and junctions to structure.

Serienbeschreibung - Fortsetzung

Wärmedämmverbundleisten:

Durchgehende Wärmedämmleisten aus hochwertigem Kunststoff, faserverstärkt, wärmebeständig bis 200°C/15 Minuten.

Profilverbindungstechnik:

- Rahmenecken (Gehrungsecken) mit hohlkammerfüllenden Spreiz-Gusseckwinkeln, mechanisch gesichert und mittels einseitiger Klebstoffinjektion zusätzlich verklebt. Mechanische Sicherung wahlweise mit Hülsen, Bolzen, Kegelschrauben oder Presstaverbindung.
- Eckverbinder wahlweise aus Al-Strangpress-Eckwinkeln im Selbstzuschnitt, mechanisch gesichert und geklebt.
- Profilstöße (Kämpferstoßverbindungen) mit Aluminiumverbindern, mechanisch gesichert und mittels Klebstoffinjektion zusätzlich verklebt. Mechanische Sicherung wahlweise mit Hülsen, Bolzen oder Kegelschrauben.
- Gehrungsecken und Kämpferstoßverbindungen mit Kunststoff-Formteilen hinterlegt für nachträgliche Kleberinjektion.

Dichtungsprofile:

- Anschlagdichtungen in den Türflügelprofilen aus EPDM, innen und außen mit Formecken.
- Verglasungsdichtungen aus EPDM/EPDM Schaum, außen und innen umlaufend (kein Gehrungsschnitt notwendig).
- Großvolumige Schwellenanschlagdichtung aus EPDM mit seitlichen, kammerfüllenden Formecken.
- Schwellendichtung aus EPDM mit Abdeckung der thermisch getrennten Schwelle und Anschlagbereich zur Schwellenanschlagdichtung.

Dampfdruckausgleich und Entwässerung:

Generell gelten die üblichen Regeln der Fachliteratur und der Glasindustrie für Dampfdruckausgleich und Entwässerung für Profilsysteme.

Dampfdruckausgleich aus freien Falzräumen über Öffnungen an den tiefsten Stellen der Fälze. Bei Türflügeln mit Sockel und bei umlaufenden Flügelprofilen verdeckt nach unten über die Hohlkammer vor die Schwellendichtung. Wahlweise Falzentwässerung mit Abdeckkappen möglich.

Wärmedämmung:

U_f - Werte nach DIN EN ISO 10077.

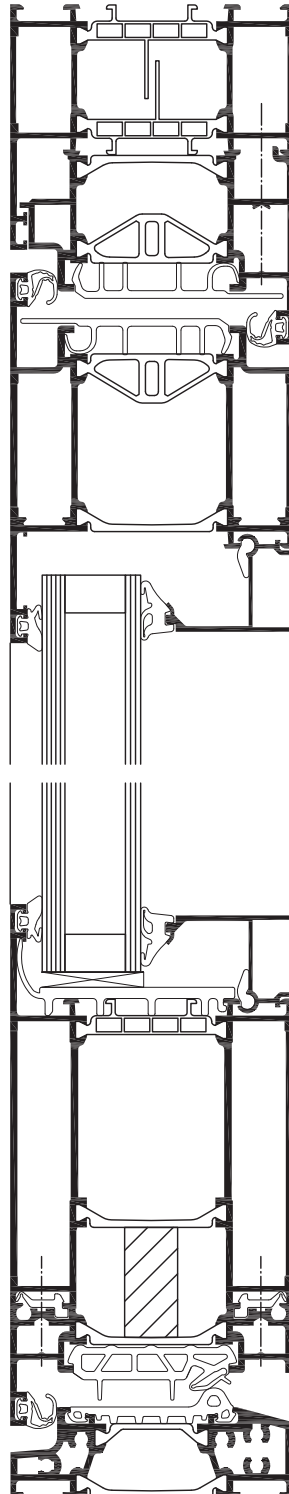

Anschlagtür, auswärts mit Kombinationsblendrahmen und Sockelprofil

Hinged door with combination frame and bottom rail profiles, outwards

Description of series - Continuation

Composite insulation strips:

Continuous thermal break strips made of high-grade plastic, fibre reinforced, heat resistant up to 200°C/15 minutes.

Profile connecting technique:

- Frame corners (mitre corners) connected by cavity-filling expanding cast aluminium corner angles, secured mechanically and additionally glued by injection procedure from one side. Mechanical safeguarding, optionally with drive bushes, bolts, conical screws or crimped connection.
- Optionally, corner angles made of extruded aluminium in self-cut, secured mechanically and glued.
- Profile butt-joints (transom butt-joints) with aluminium connectors, secured mechanically and glued additionally by injection procedure. Mechanical safeguarding, optionally with drive bushes, bolts or conical screws.
- Mitre corners and transom butt-joints backed by moulded plastic parts for subsequent glue injection.

Gasket profiles:

- Stop gaskets made of EPDM in door leaf profiles, inside and outside with moulded gasket angles.
- Circumferential (all-around) outer and inner glazing gaskets made of EPDM/EPDM foam (no mitre cut).
- Large-volume threshold stop gasket made of EPDM with lateral, chamber filling moulded gasket angles.
- Threshold gasket made of EPDM covering thermal break of threshold with end stop for leaf gasket.

Air pressure equalization and drainage:

Generally valid are the conventional rules of technical literature and glass industry for air pressure equalization and drainage.

Air pressure equalization from open rebate areas via openings at the lowest point of rebates. Concealed in door leaves with bottom rail and in circumferential (all-around) leaf profiles towards bottom via hollow chamber in front of threshold gasket. Optionally, rebate drainage with weephole covers is possible.

Thermal insulation:

U_f - value according to EN ISO 10077.

Serienbeschreibung - Fortsetzung

Beschläge:

RAL-geprüfte Türen mit systemabgestimmten Beschlägen und Türschließmitteln namhafter Hersteller. Tür-Rollenbänder in Aluminiumausführung und Aluminium-Aufschraubbänder. Zulässige Tür-Füllungsgewichte von 100 kg bis max. 200 kg, mit Einschränkungen bis 400 kg.

Oberflächenbehandlung der Profile:

Alle üblichen Eloxalverfahren nach DIN 17611 bzw. den Bestimmungen für das Gütezeichen für anodisch erzeugte Oxidschichten auf Aluminium Halbzeugen (Ausgabe 15. September 2004) der Qualanod Zürich, CH-8027 Zürich und Beschichtungsverfahren nach Erlangung eines Gütezeichens für Beschichtungen auf Aluminium durch Pulver- oder Nasslackierungen bei Architektur Anwendungen (Ausgabe 1. April 2006) der Qualicoat Gütegemeinschaft, Zürich, CH-8027 Zürich sind auszuführen. Unterschiedliche Farbgestaltungen der Innen- und Außenprofilschalen vor dem Verbinden sind möglich.

Verglasungen:

Die allgemeinen Verglasungsvorschriften der Glasindustrie sind zu beachten. Verglasung, Trockenverglasung zwischen Elastomer-Dichtungen.

- Klotzung auf systemeigenen Kunststoff-Vorklötzen.
- Allgemeine Verklotzungsvorschriften sind zu beachten.
- Füllungsdicken von 6 - 60 mm im Standard Profilsystem (siehe auch Verglasungstabellen).

Systemkombinationen:

- WICSTYLE 75 Türen sind kombinierbar mit WICLINE 75 Fenster.
- Mit Spannblendrahmen für WICLINE 75 in die aktuellen WICTEC-Fassaden-Programme einsetzbar.

Description of series - Continuation

Fittings:

RAL-tested doors with system specific fitting and door closers of renowned manufacturers. Aluminium butt hinges and surface mounted screwed hinges. Admissible door infill weights from 100 kg up to maximum 200 kg, with restrictions up to 400 kg.

Surface treatment of profiles:

All conventional anodic treatments should be carried out according to DIN 17611 and quality mark clauses for oxide layers on semi-finished aluminium (15th september 2004 Edition) of Qualanod Zürich, CH-8027 Zürich and coating procedures after obtainment of a quality mark for powder or wet coatings on aluminium in architectural applications (1st April 2006 Edition) of Qualicoat Gütegemeinschaft, Zürich, CH-8027 Zürich. Different colour shades of inner and outer profile shells are possible prior to connecting.

Glazings:

Consider the general prescriptions of glass industry. Glazings between elastomer gaskets (dry glazing).

- *Shimming on system plastic shims.*
- *General shimming regulations should be considered.*
- *Infill thicknesses from 6 up to 60 mm in standard profile system (see also glazing tables).*

System combinations:

- *WICSTYLE 75 doors can be combined with WICLINE 75 windows.*
- *Can be integrated into the current WICTEC façade range using the WICLINE 75 clamping frame.*

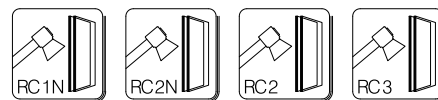

Einbruchhemmende Ausführung

Vorbemerkung:

WICSTYLE 65/75 Türen einbruchhemmend, mit und ohne Panikfunktion sind nach DIN EN 1627:2011 in den Widerstandsklassen RC 1 N/ RC 2 N/ RC 2 / RC 3 geprüft.

Sie sind eine Ergänzung zur Standardserie. Sämtliche Merkmale, Eigenschaften, sowie die Verarbeitung bleiben unverändert. Die einbruchhemmenden Eigenschaften in den einzelnen Widerstandsklassen werden ausschließlich erreicht durch:

- Geprüfte Einsteck- oder Mehrfachverriegelungsschlösser klassifiziert nach EN 12209
- Standard Beschläge in Verbindung mit Anbohrschutz, oder wahlweise Schutzbeschläge klassifiziert nach EN 1906
- Bandseitensicherung mittels Abdeckprofil bei freier Bandauswahl
- Verglasungen, Sandwich- oder Glaspaneele, klassifiziert nach EN 356
- zusätzliche Füllungssicherung bei Widerstandsklasse RC 2/ RC 3

Öffnungs- und Ausführungsarten:

In allen Widerstandsklassen sind 1- und 2- flügelige Türen in den Standard-Ausführungsvarianten, ein- und auswärts öffnend, sowie mit oder ohne Schwelle möglich.

Ebenso auch als Flucht- oder Paniktüren.

RC 1 N/RC 2 N:

- 1-flügelige Standard- oder Fluchttüren nach EN 179 / EN 1125
- 2-flügelige Standard- oder Fluchttüren nach EN 179 / EN 1125 in Ausführung Teilpanik oder Vollpanik

RC 2:

- 1-flügelige Standard- oder Fluchttüren nach EN 179 / EN 1125
- 2-flügelige Standard- oder Fluchttüren nach EN 179 / EN 1125 in Ausführung Teilpanik oder Vollpanik (mit Mehrfachverriegelungsschlössern, 3-fach)

RC 3:

- 1-flügelige Standard- oder Fluchttüren nach EN 179 / EN 1125
- 2-flügelige Standard- oder Fluchttüren nach EN 179 / EN 1125 in Ausführung Teilpanik (mit Mehrfachverriegelungsschlössern 3-fach)

Sicherung der Füllungen:



Grundsätzlich keine Füllungssicherung erforderlich;
Zusätzliche Distanzverklötzung bei FH > 1.500 mm



Trockensicherung, oder wahlweise Nassverklebung;
Flucht-/Paniktüren nur mit Nassverklebung



Nassverklebung

Burglar resistant version

Preliminary remarks:

WICSTYLE 65/75 burglar resistant doors, with or without panic function have been tested to DIN EN 1627:2011 for the resistance classes RC 1 N/ RC 2 N/ RC 2/ RC 3.

They are a complement to the standard series. All features, properties as well as the manufacturing process remain unchanged. The burglar resistant properties in the specific burglar resistant classes are achieved exclusively through:

- Tested mortise or multi-point locks classified according to EN 12209
- Standard fittings in connection with drilling protection or selectively Protective fittings classified according to EN 1906
- Hinge sided safeguard by means of cover profile with free selection of hinges
- Glazings, sandwich or glass panels classified according to EN 356
- Additional infill safeguard for resistance class RC 2/ RC 3

Opening types and design types:

Single and double leaf doors in standard variants, opening inwards and outwards as well as with or without threshold in all resistant classes are possible.

Likewise, also as escape or panic doors.

RC 1 N/RC 2 N:

- Single leaf standard or escape doors acc. to EN 179 / 1125
- Double leaf standard or escape doors acc. to EN 179 / 1125 in version partial- or full panic door

RC 2:

- Single leaf standard or escape doors acc. to EN 179 / 1125
- Double leaf standard or escape doors acc. to EN 179 / 1125 in version partial- or full panic door (with three-point locks)

RC 3:

- Single leaf standard or escape doors acc. to EN 179 / 1125
- Double leaf standard or escape doors acc. to EN 179 / 1125 in version partial panic door (with three-point locks)

Securing of the infills:



Basically no infill securing necessary;
Additional distance shimming for FH > 1.500 mm



Dry securing or alternatively wet glueing;
Escape/ panic doors only with wet glueing



Wet glueing



Durchschusshemmung nach DIN EN 1522 bis Klasse FB 4

Hinweise:

Anwendungsmöglichkeiten für Türen, Festfelder und deren Kombinationen, durchschusshemmend nach DIN EN 1522 FB4. Durch rationelle Sicherungen der durchschusshemmenden Al-Beplankungen auf vorhandenen Standard-Türen lassen sich nachfolgende Systeme herstellen:

WICSTYLE Türen, durchschusshemmend Kombinationsmöglichkeiten mit

1. WICSTYLE Türen, einbruchhemmend
2. WICLINE Fenster, durchschusshemmend
3. WICLINE Fenster, durchschusshemmend / einbruchhemmend

Ausführungsvarianten, durchschusshemmend

- 1-flügelige Türen, ein- und auswärts öffnend
- 2-flügelige Türen, ein- und auswärts öffnend (Stulpflügel ohne Aufsatzprofil)
- Standard, oder einbruchhemmend
- Fluchttüren DIN EN 179 oder Paniktüren DIN EN 1125, auswärts öffnend
- Eingeschränkte durchschusshemmende Eigenschaften (Türsockel / Fusspunkt nicht durchschusshemmend)

Durchschusshemmende Eigenschaften:

Um die durchschusshemmenden Basiseigenschaften von Türen herzustellen sind zusätzliche Maßnahmen im Türfalzbereich erforderlich.

Zur Auswahl stehen verschiedene Ausführungsvarianten.

Bei Türen mit **vollständig** durchschusshemmenden Eigenschaften sind nur Türsockelausführungen in Verbindung mit Schwellenschlag und weiteren Zusatzmaßnahmen zulässig. Für diese Türausführungen gelten die Prüfzertifikate in vollem Umfang.

Zulässig sind auch Türen mit **eingeschränkten** durchschusshemmenden Eigenschaften bei denen der Fußbodenanschluss von der Durchschusshemmung ausgenommen ist.

Hierbei sind alle Varianten von Türsockelausführungen incl. durchlaufende oder barrierefreie Fußbodenanschlüsse möglich.

Achtung:

Bei diesen Türausfertigungen sind die Türsockel- und Schwellenausführungen von der Gültigkeit der Prüfzertifikate ausgenommen. Diese Ausnahmeregelung bedarf einer besonderen Zustimmung und Freigabe je nach Anwendungsfall. Eine separate Bescheinigung des Auftraggebers ist einzuholen.

Zu beachten:

Auf Durchschusshemmung geprüfte Profile sind

Türflügelprofile:

1926511, 1926514, 1927511, 1927514

Blendrahmenprofile:

1916004, 1917004

Kämpferprofile:

1916205, 1917205

Zusatzprofile:

1926520, 1927520, 1926522, 1927522 (Wechselprofile ein-/auswärts)

1926530, 1927530, 3925094

Bullet resistance according to DIN EN 1522 up to class FB 4

Remark:

Application possibilities for doors, fixed fields and their combinations, bullet resistant according to DIN EN 1522 FB4. Following systems can be fabricated by efficient securing bullet resistant aluminium planking on existing standard doors:

WICSTYLE doors, bullet resistant

Combination possibilities with

1. WICSTYLE doors, burglar resistant
2. WICLINE windows, bullet resistant
3. WICLINE windows, bullet resistant / burglar resistant

Design versions, bullet resistant

- Single leaf doors, inward and outward opening
- Double leaf doors, inward and outward opening (secondary leaf without supplementary profile)
- Standard, or burglary resistant
- Escape doors DIN EN 179 or panic doors DIN EN 1125, outward opening
- Restricted bullet resistant properties (bottom rail / base point not bullet resistant)

Bullet resistant properties:

To realize the basic bullet resistant properties of doors, additional measures have to be implemented in the door rebate area.

Various design versions are offered.

For doors with **complete** bullet resistant properties, only door bottom rail designs combined with threshold stop and further additional measures are permitted.

For these door designs, the test certificates are valid in their entirety.

Also doors with **limited** bullet resistant properties where the floor junction area has no bullet resistant properties are permitted.

In that case, all threshold design variants are possible including continuous or barrier-free floor junctions.

Careful:

For these door constructions, the door bottom rail and threshold designs are outside the scope of validity of the test certificates. This exemption regulation requires a specific approval and clearance related to the application.

A separate certificate issued by the awarding authority must be obtained.

Please note:

Profiles tested for bullet resistance are

Door leaf profiles:

1926511, 1926514, 1927511, 1927514

Frame profiles:

1916004, 1917004

Transom profiles:

1916205, 1917205

Supplementary profiles:

1926520, 1927520, 1926522, 1927522 (Reversion profiles in-/outward)

1926530, 1927530, 3925094

Profilübersicht
Survey of Profiles

Blendrahmenprofile
Frame profiles

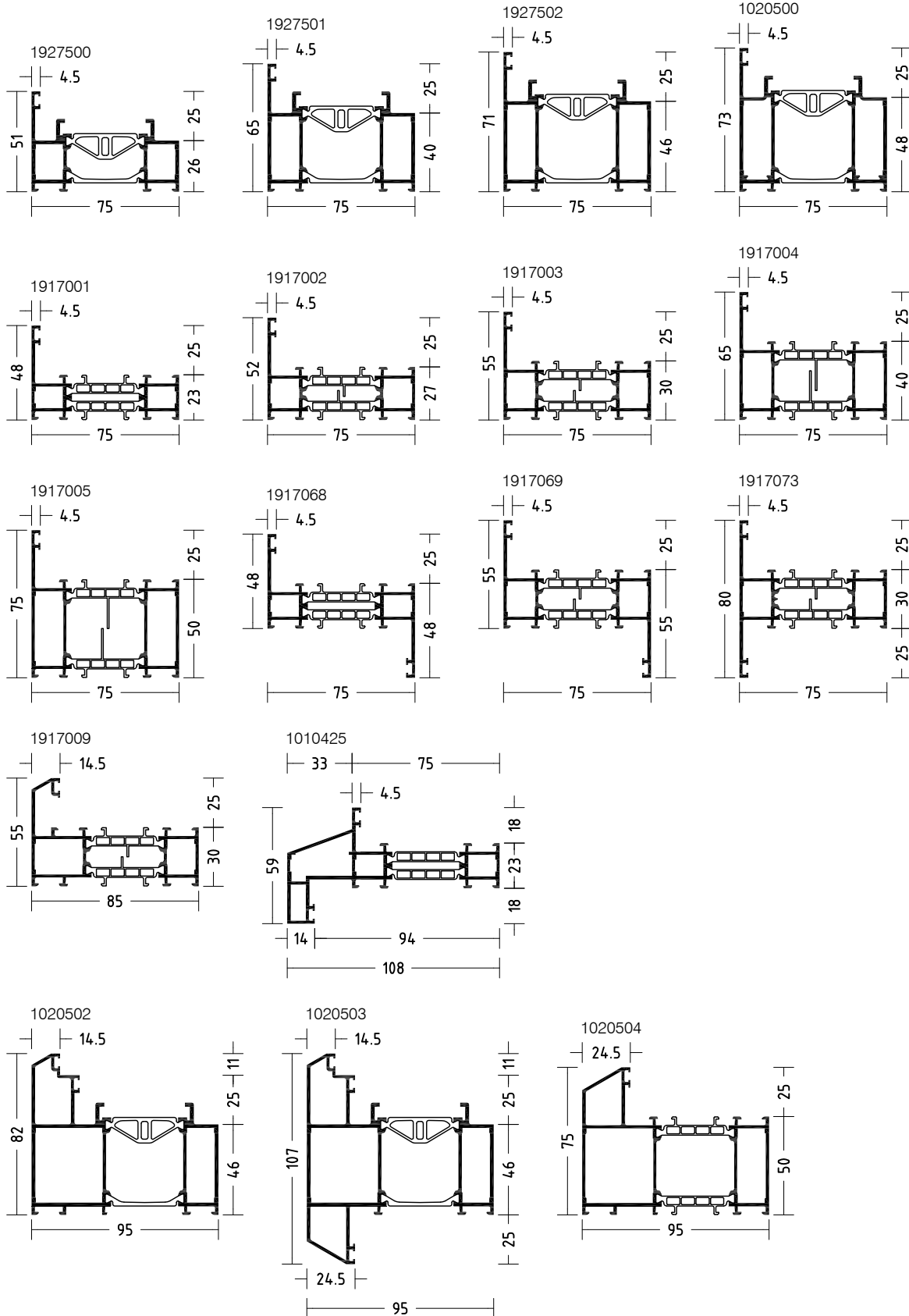

Einspann-Blendrahmenprofile Clamping frame profiles

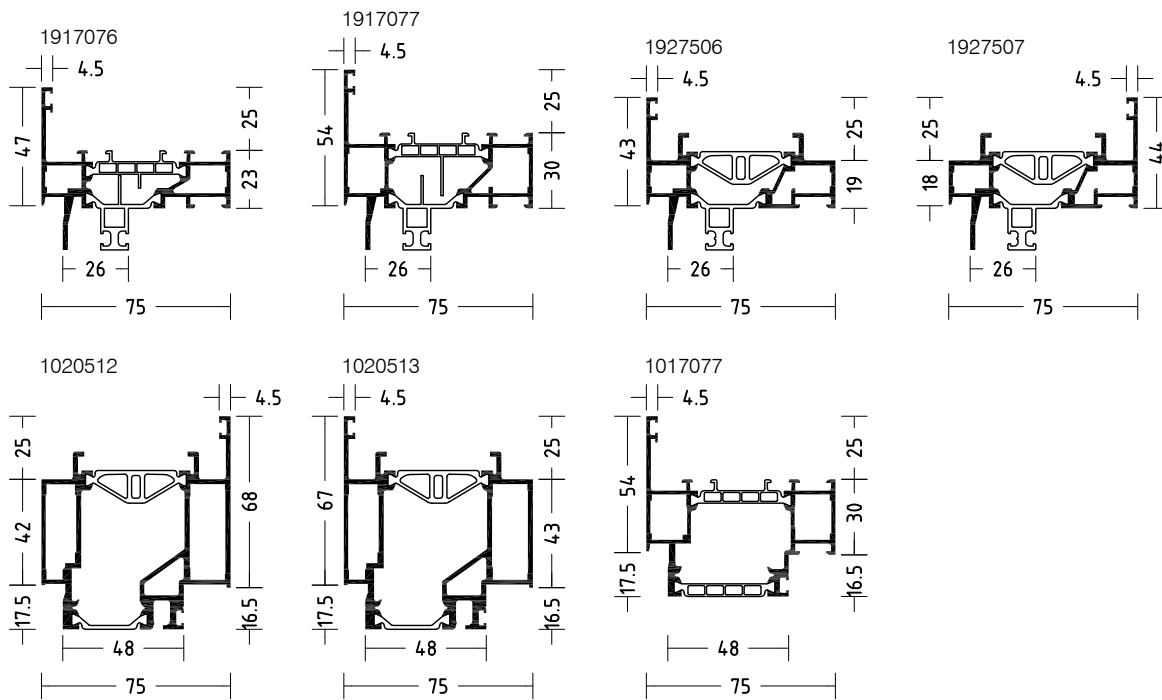

Profilübersicht
Survey of Profiles

Flügelprofile nach Innen öffnend
Leaf profiles inwards

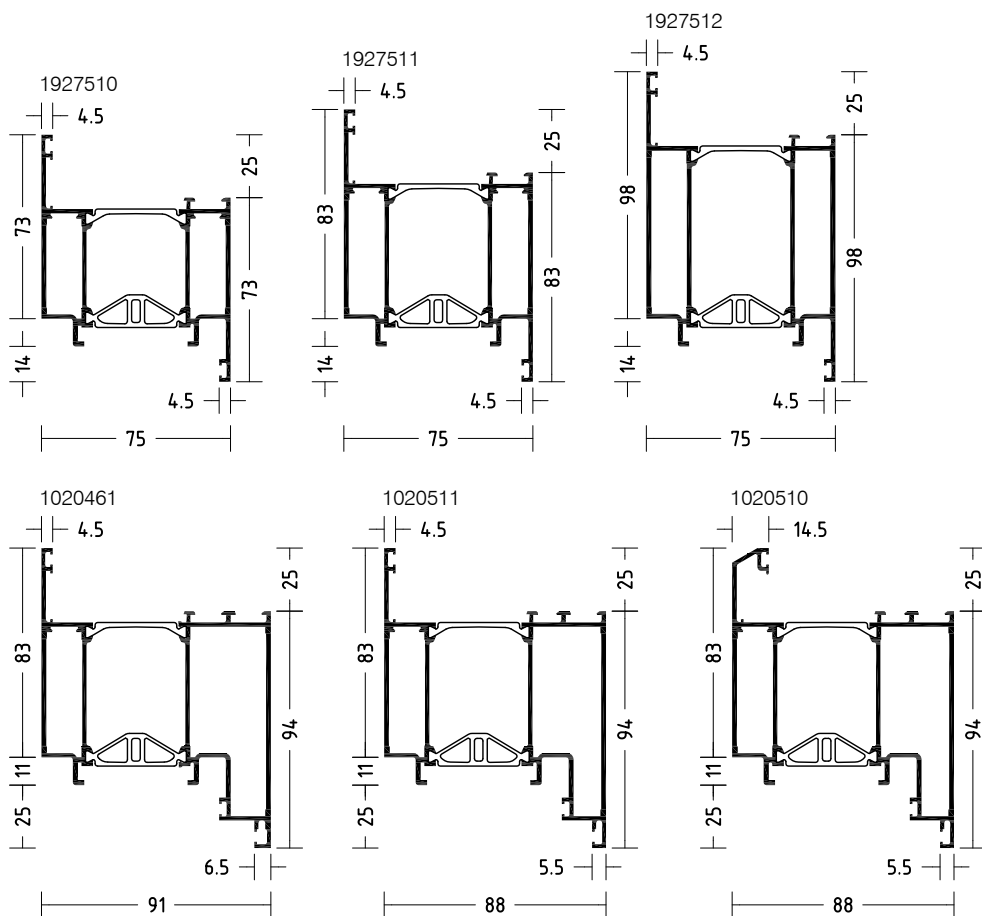

Flügelprofile nach Außen öffnend
Leaf profiles outwards

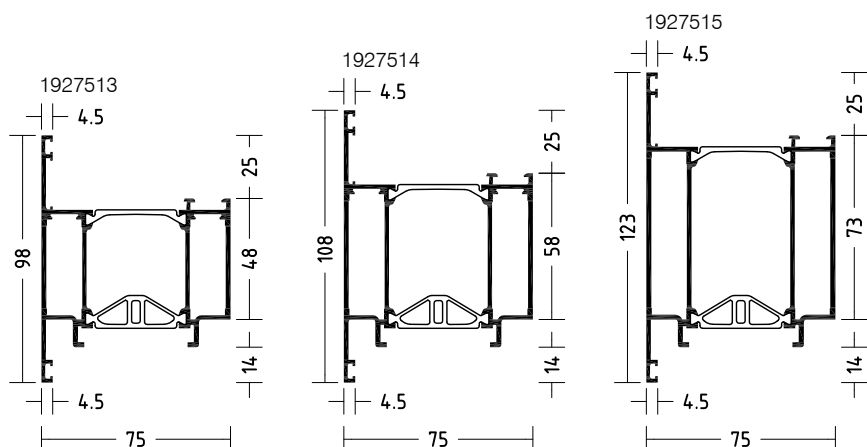

WICSTYLE 75 evo

Technische Information Technical Information

Profilübersicht Survey of Profiles

Flügelprofile für einseitig flügelüberdeckende Füllung Leaf profiles for single-sided leaf overlapping infill

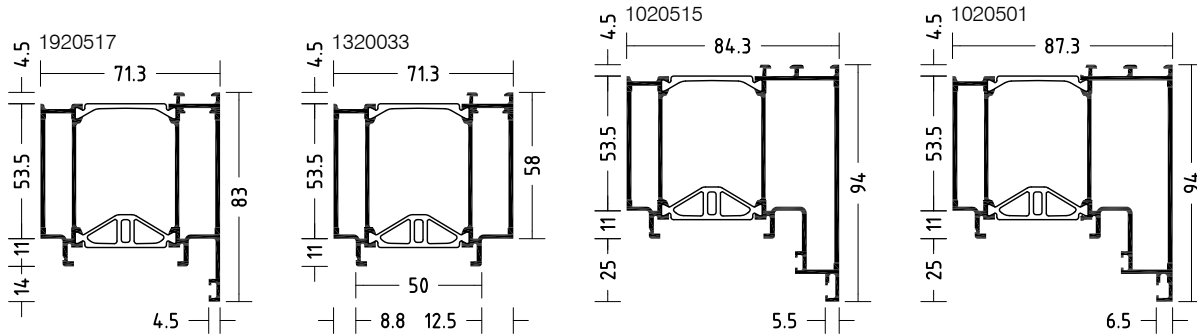

Flügelprofile für beidseitig flügelüberdeckende Füllung Leaf profiles for both-sided leaf overlapping infill

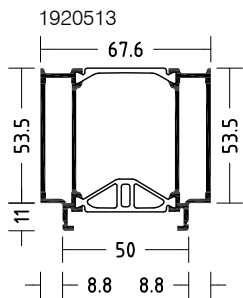

Sockelprofile Bottom rail profiles

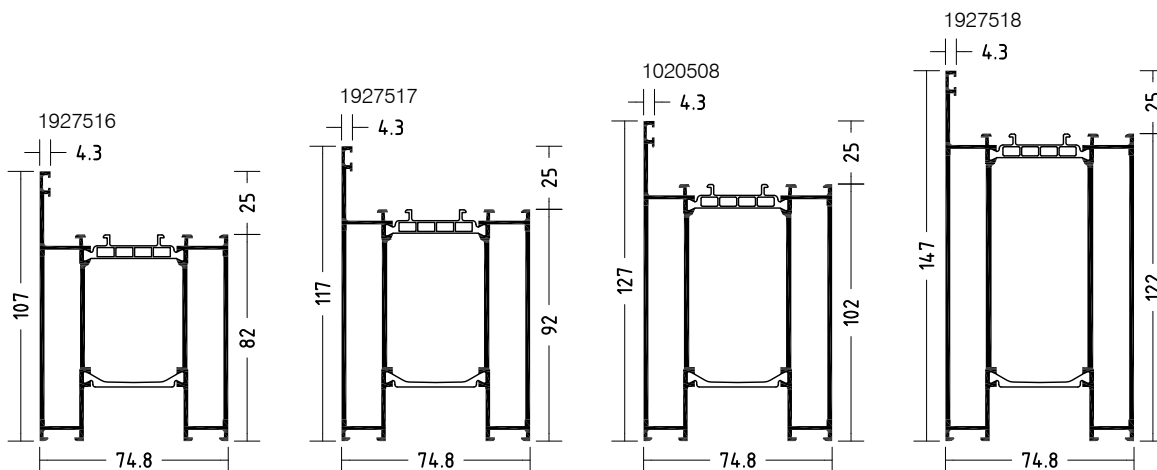

WICSTYLE 75 evo

Profilübersicht
Survey of Profiles

Technische Information
Technical Information

Sockelprofile
Bottom rail profiles

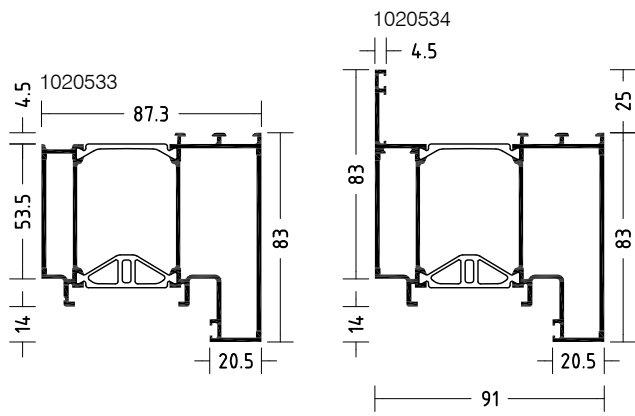

Profilübersicht Survey of Profiles

Falzverbreiterungsprofile Rebate widening profiles

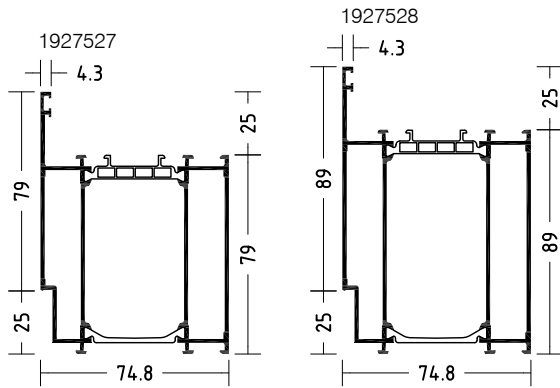

Kämpferprofile Transom profiles

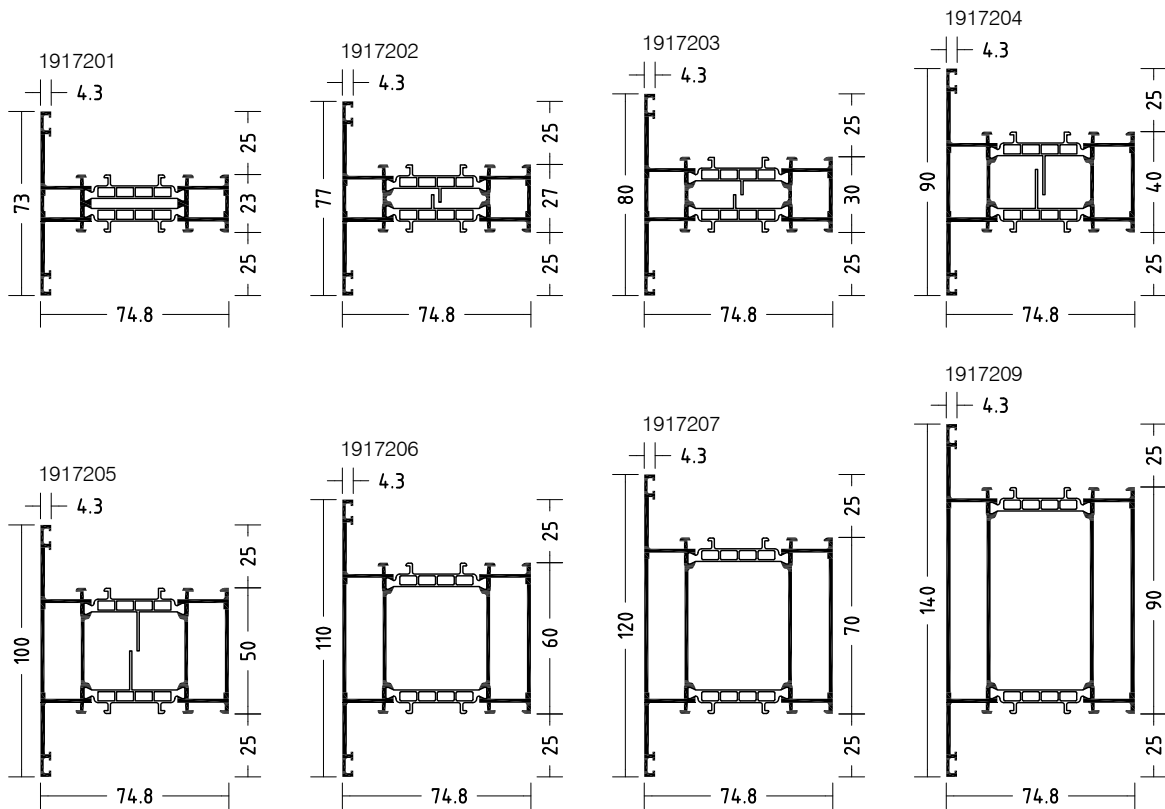

WICSTYLE 75 evo

Profilübersicht
Survey of Profiles

Technische Information
Technical Information

Kämpferprofile
Transom profiles

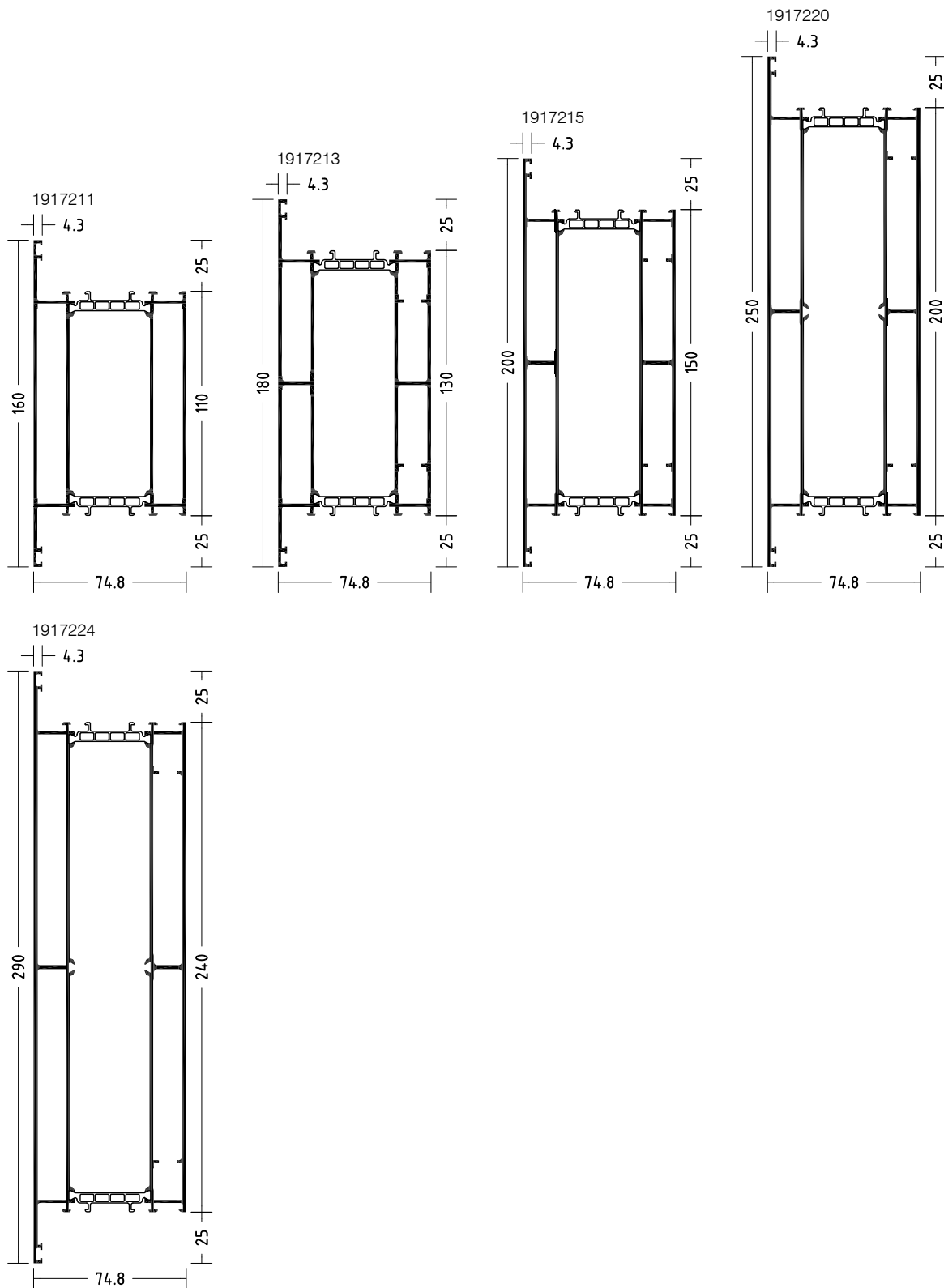

Profilübersicht
Survey of Profiles

Stützenprofile nach außen verstärkt
Externally reinforced mullion profiles

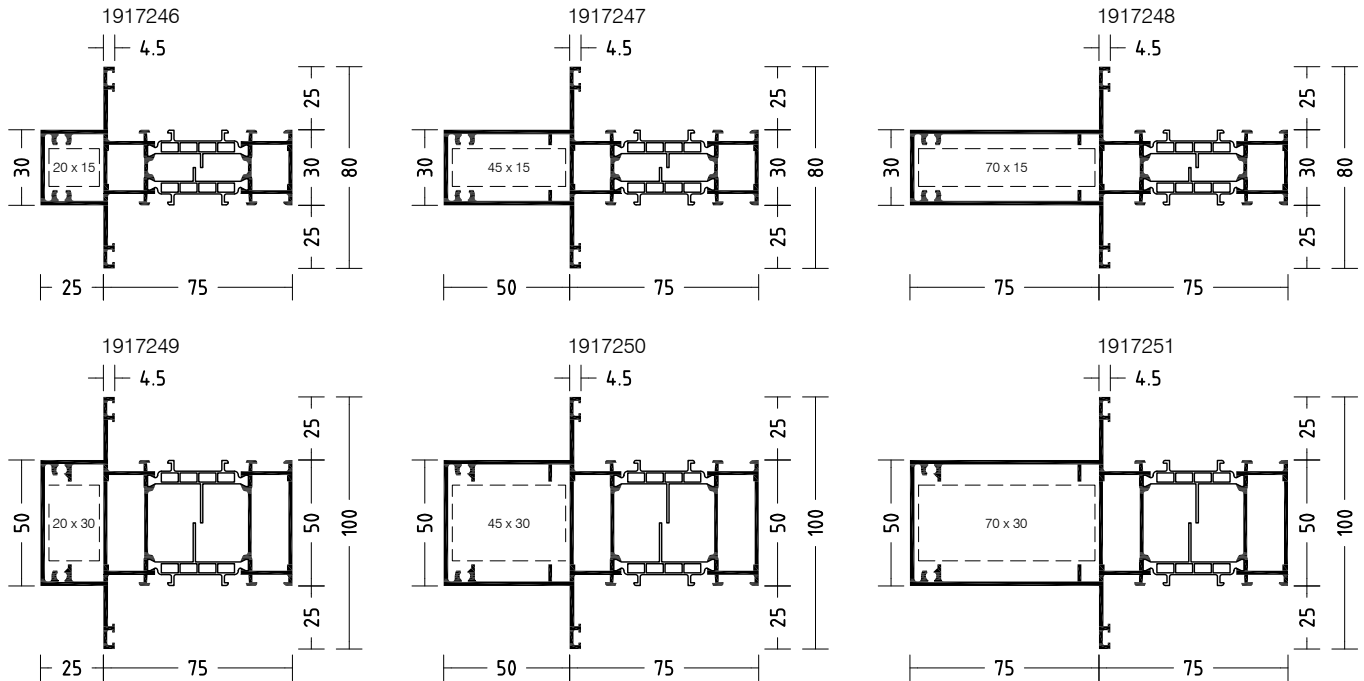

Stützenprofile nach innen verstärkt
Internally reinforced mullion profiles

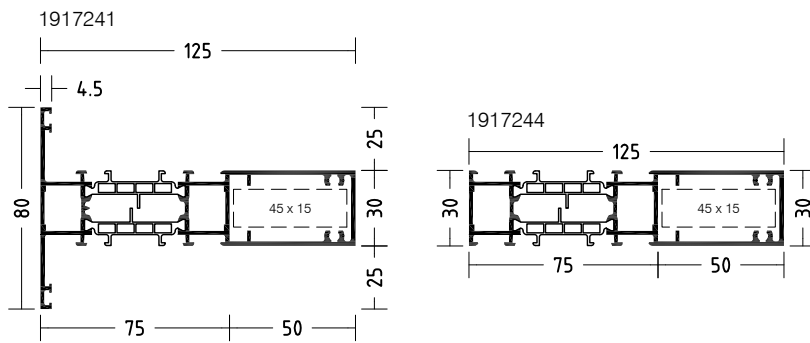

Stützenprofile
Mullion profiles

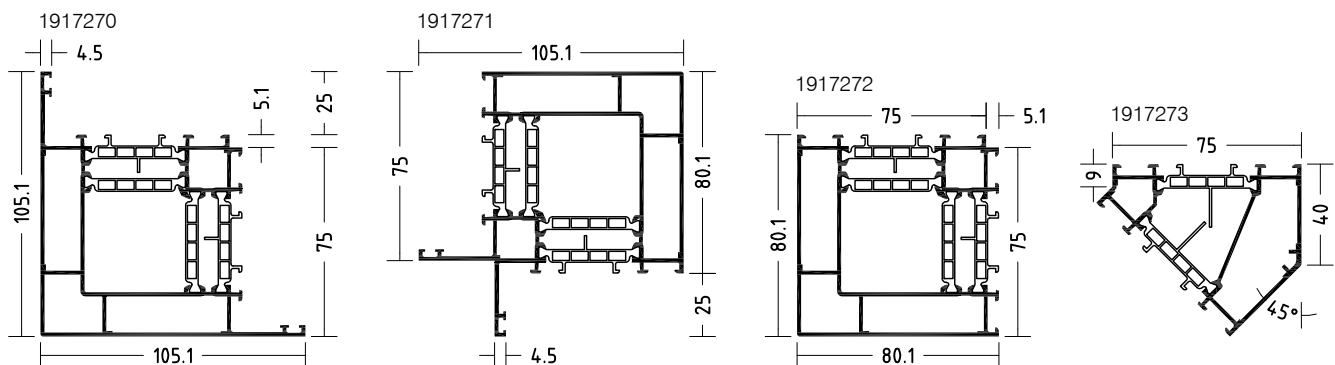

Profilübersicht
Survey of Profiles

Sprossenprofile
Glazing bar profiles

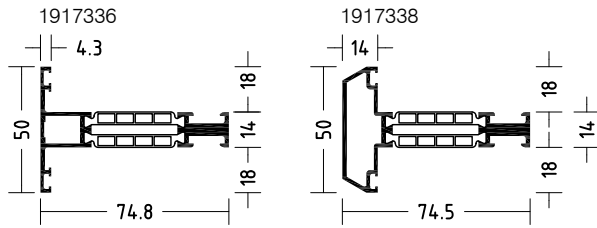

Schwellenprofile
Threshold profiles

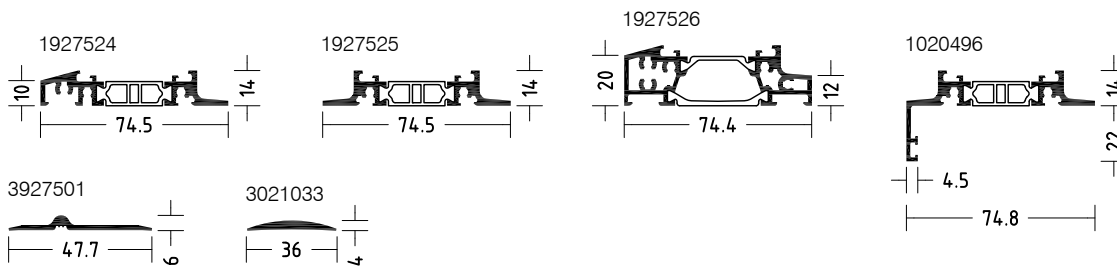

Aufsatzprofile
Supplementary profiles

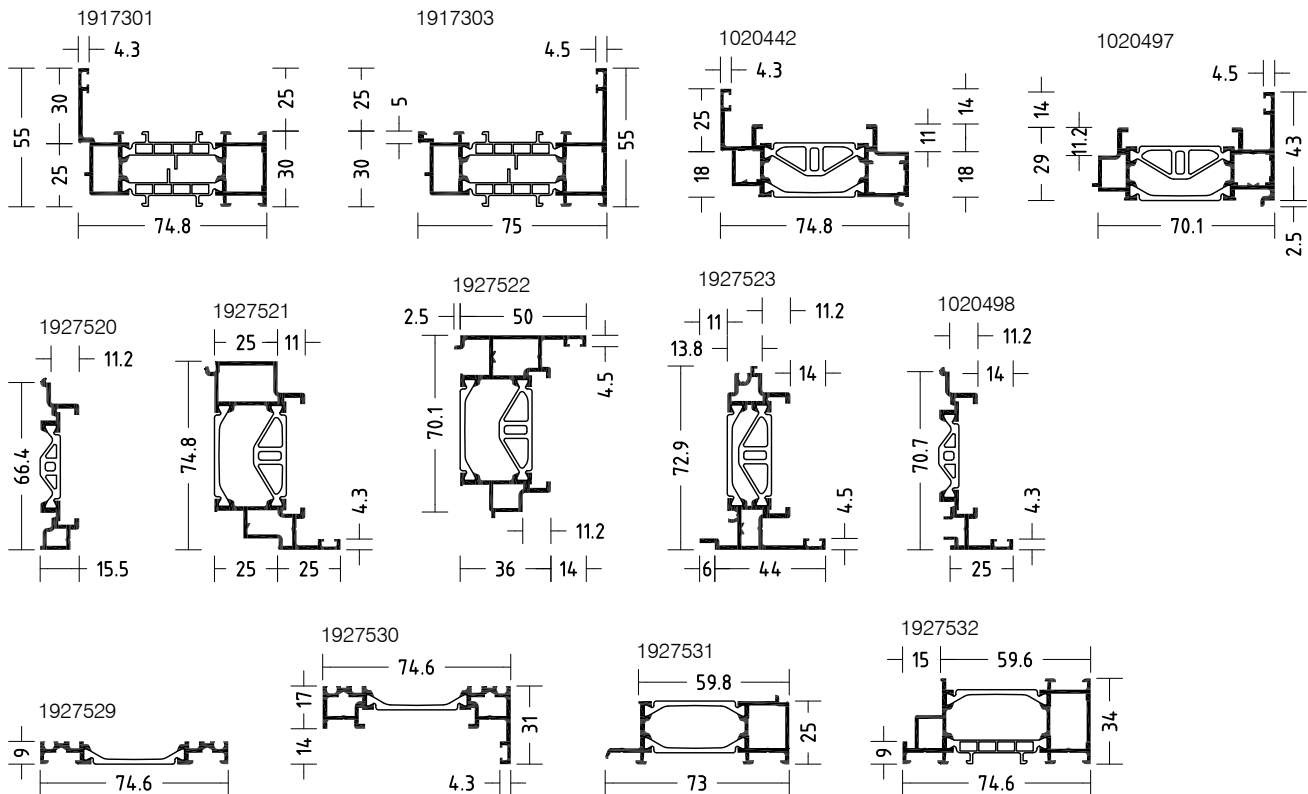

Profilübersicht
Survey of Profiles

Aufsatzprofile
Supplementary profiles

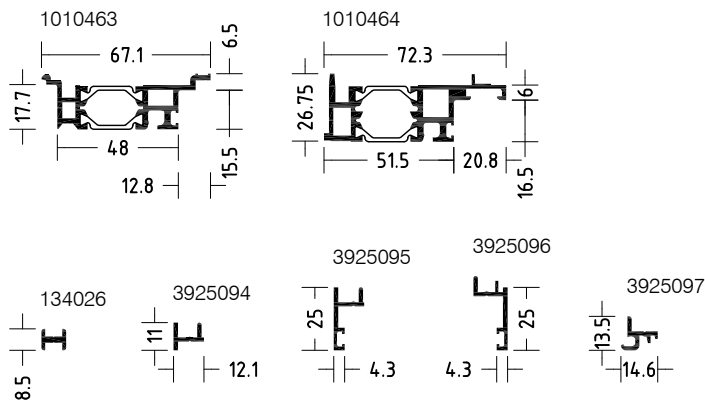

Neutralprofile
Neutral profiles

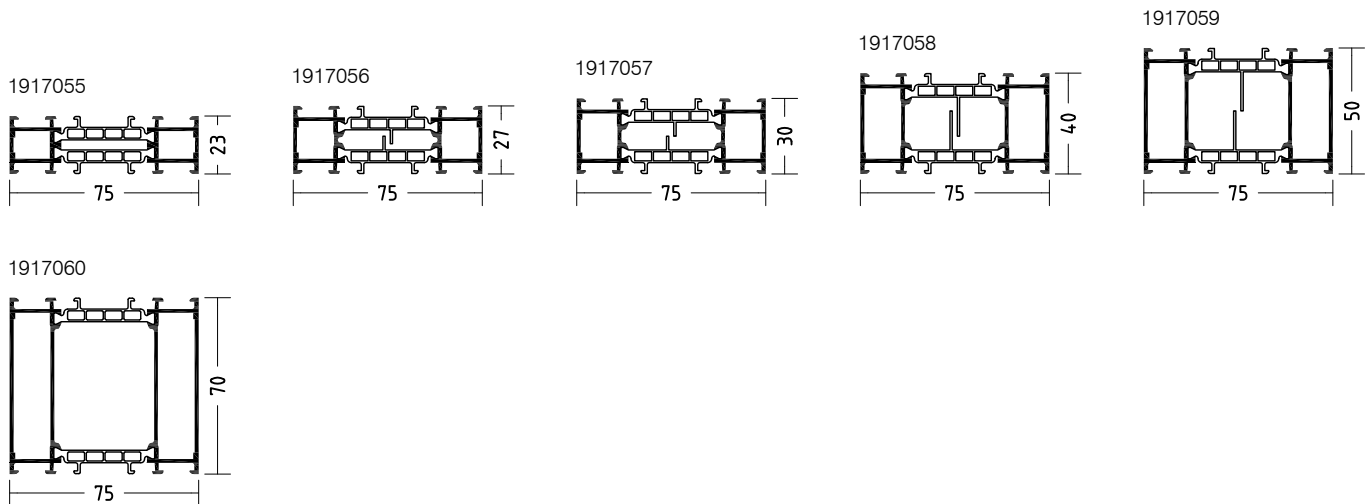

Profilübersicht
Survey of Profiles

Dehnstoßprofile
Expansion joint profiles

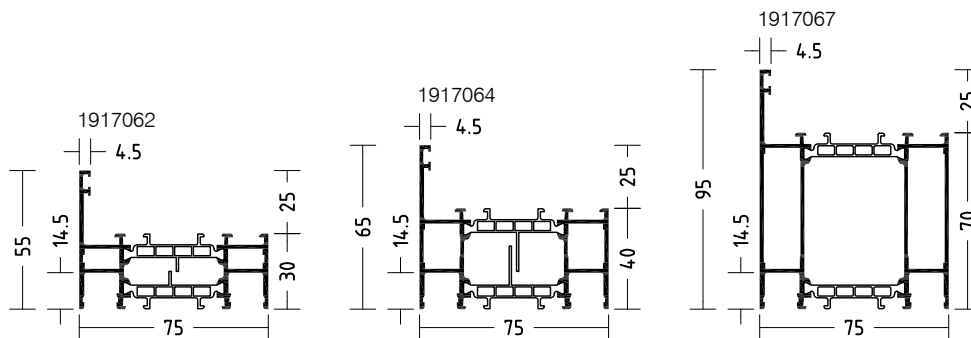

Stützenprofile geteilt nach außen verstärkt
Externally reinforced split mullion profiles

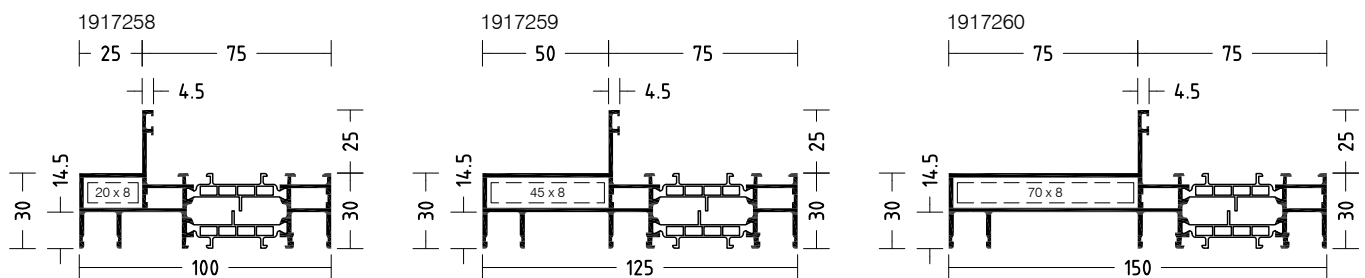

Stützenprofile geteilt nach innen verstärkt
Internally reinforced split mullion profiles

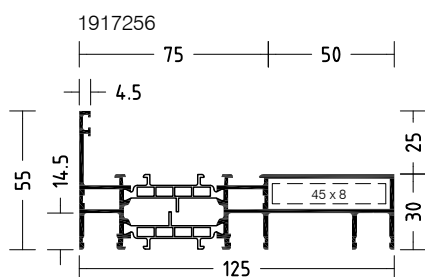

Profilübersicht Survey of Profiles

Glasleistenprofile 18 mm

Glazing bead profiles 18 mm

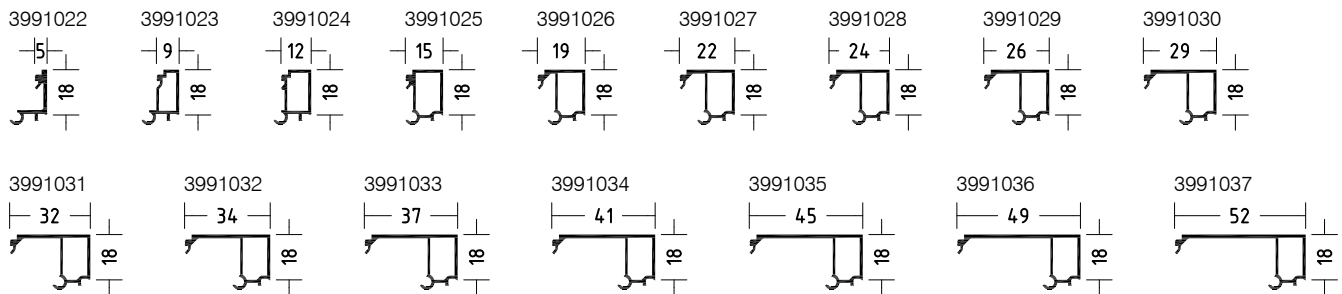

Glasleistenprofile 22 mm



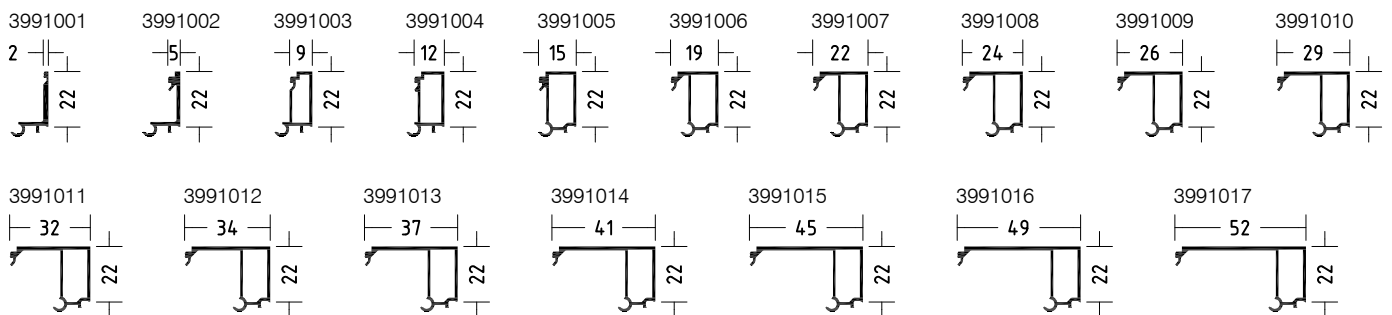





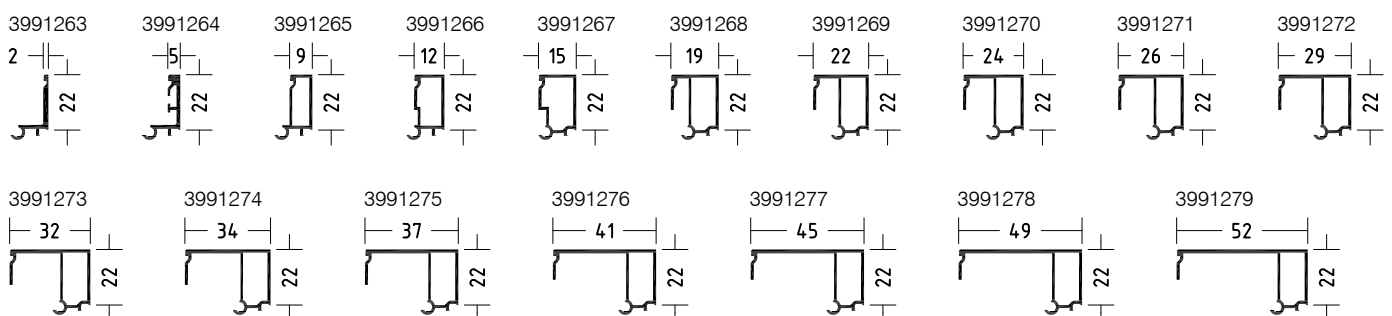



Glazing bead profiles 22 mm



Glasleistenprofile Trockenverglasung / Nassverglasung

Glazing bead profiles dry glazing / wet glazing



												
	m	mm	mm									
 1917001	6,5	285	71	4950006	2x4070000	1x4960002	1x4070000	-	5910006	5940101	5940001	5930003
				4950006	2x4070000	1x4960002	1x4070000	-	5910006	5940101	5940001	5930003
1917002	6,5	293	79	4950007	2x4070000	1x4960003	1x4070000	1x4070030	5910006	5940101	5940001	5930003
				4950007	2x4070000	1x4960003	1x4070000	1x4070030	5910006	5940101	5940001	5930003

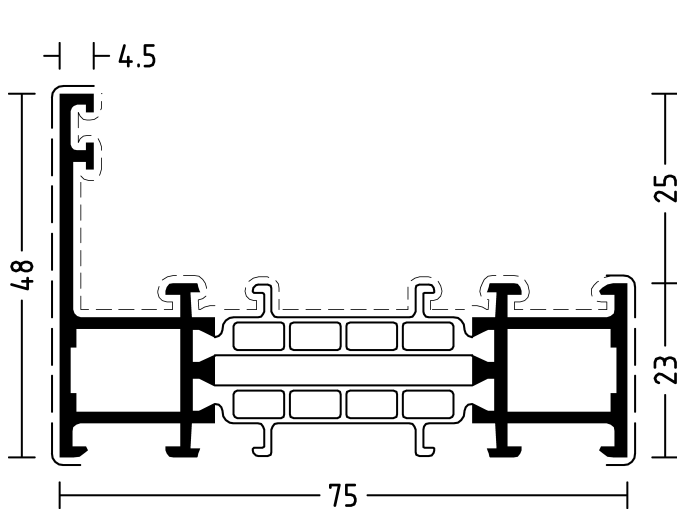





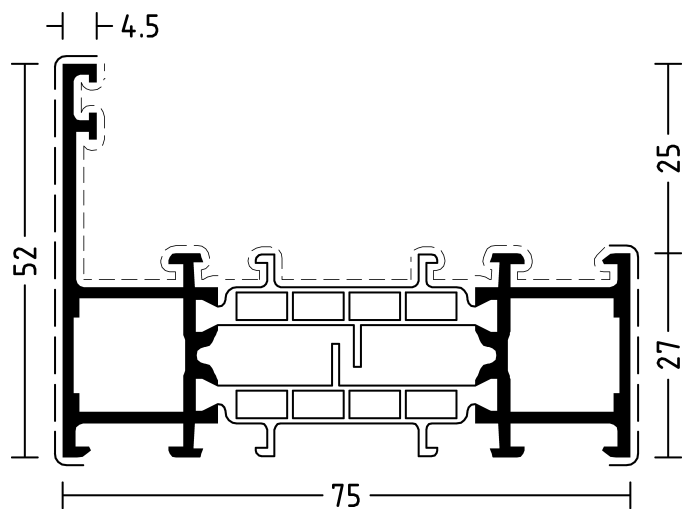









1917001

Gelenckwinkel und Gelenkverbinder siehe Zusatzartikel.
See additional articles for hinged corner angles and hinged connectors.



1917002

Gelenckwinkel und Gelenkverbinder siehe Zusatzartikel.
See additional articles for hinged corner angles and hinged connectors.

												
	m	mm	mm									
 1917003	6,5	299	170	4950008	2x4070000	1x4960004	1x4070000	1x4070030	5910006	5940101	5940001	5930003
				4950008	2x4070000	1x4960004	1x4070000	1x4070030	5910006	5940101	5940001	5930003
1917004	6,5	319	105	4950009	2x4070000	1x4960005	1x4070000	1x4070030	5910006	5940101	5940001	5930003
				4950009	2x4070000	1x4960005	1x4070000	1x4070030	5910006	5940101	5940001	5930003

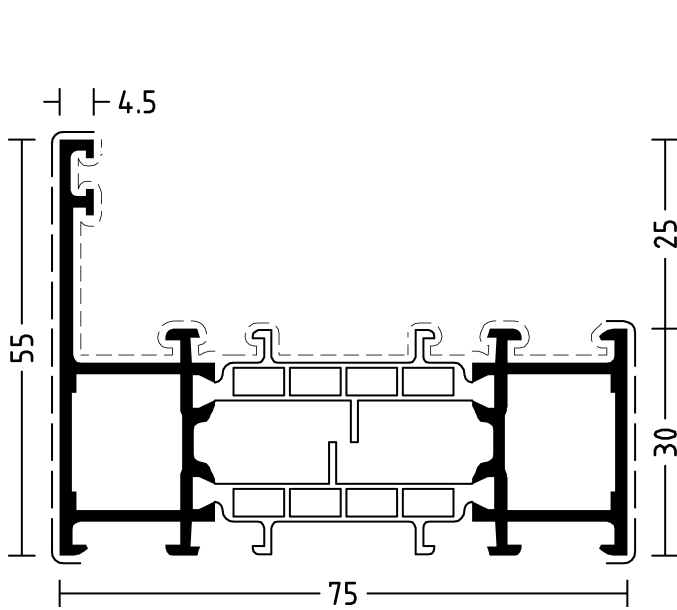

1917003

Gelenckwinkel und Gelenkverbinder siehe Zusatzartikel.
See additional articles for hinged corner angles and hinged connectors.

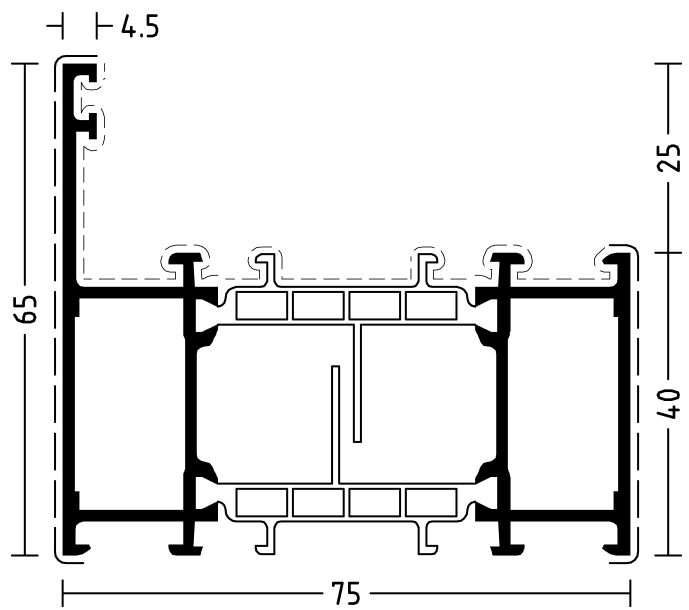















1917004









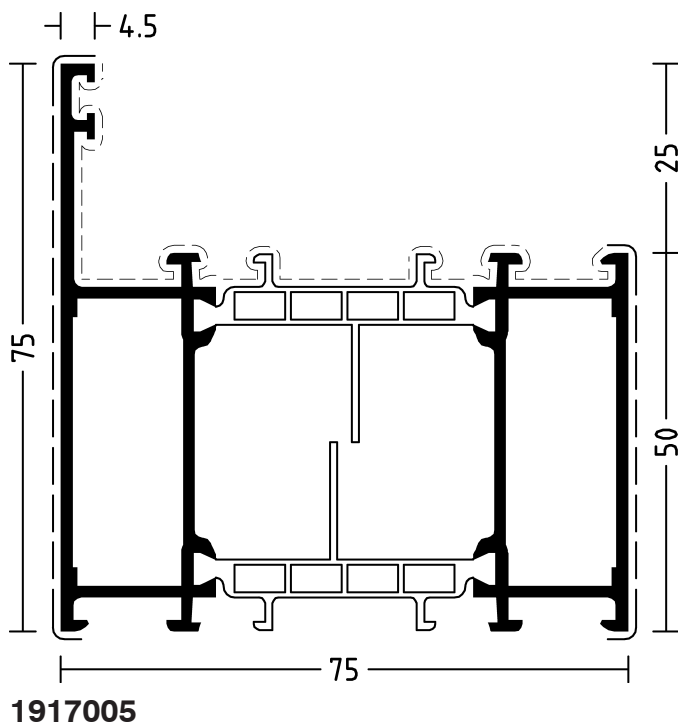





Gelenckwinkel und Gelenkverbinder siehe Zusatzartikel.
See additional articles for hinged corner angles and hinged connectors.

WICSTYLE 75 evo

Blendrahmenprofile Frame profiles

												
	m	mm	mm									
 1917005	6,5	339	125	4950010	2x4070000	1x4960006	1x4070000	1x4070030	5910006	5940101	5940001	5930003
				4950010	2x4070000	1x4960006	1x4070000	1x4070030	5910006	5940101	5940001	5930003



													
	1917009	6,5	356	91	4950012	2x4070000	1x4960004	1x4070000	1x4070030	5910013	5940101	-	5930005
					4950008	2x4070000	1x4960004	1x4070000	1x4070030	5910013	5940101	-	5930005
	1917055	6,5	222	46	4950006	2x4070000	1x4960002	1x4070000	-	5910006	5940101	5940001	5930003
					4950006	2x4070000	1x4960002	1x4070000	-	5910006	5940101	5940001	5930003
	1917056	6,5	230	54	4950007	2x4070000	1x4960003	1x4070000	1x4070030	5910006	5940101	5940001	5930003
					4950007	2x4070000	1x4960003	1x4070000	1x4070030	5910006	5940101	5940001	5930003

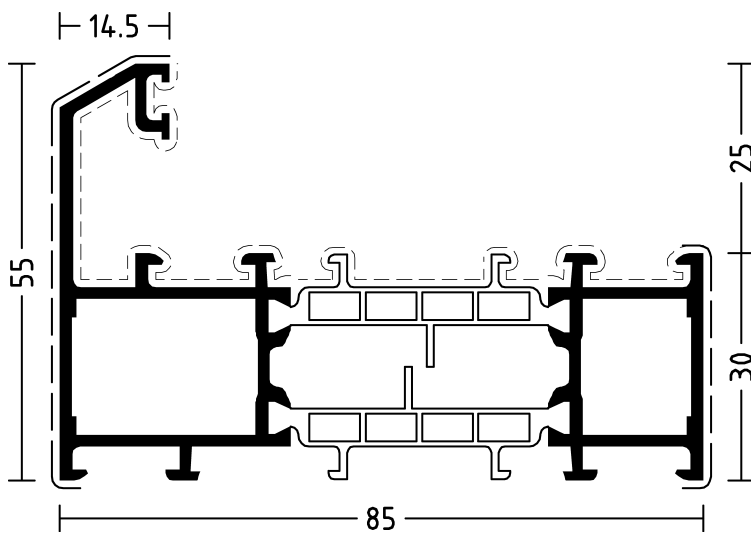

1917009



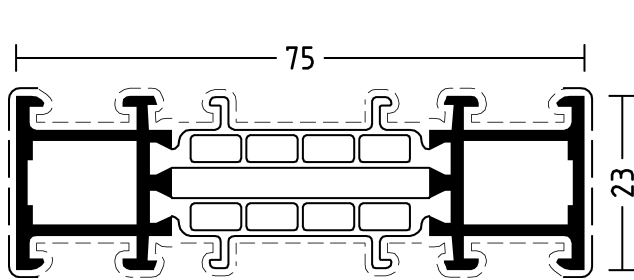

Blendrahmen Klassik-Design
Frame Classic design

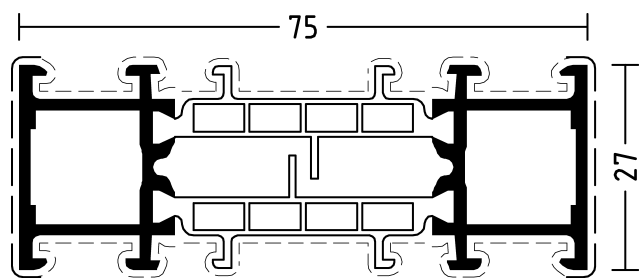

1917055

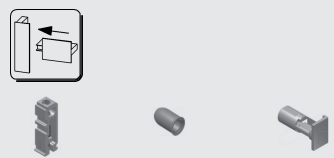

1917056

	m	mm	mm									
				4950008	2x4070000	1x4960004	1x4070000	1x4070030	5910006	5940101	5940001	5930003
 1917057	6,5	236	60	4950008	2x4070000	1x4960004	1x4070000	1x4070030	5910006	5940101	5940001	5930003
 1917058	6,5	256	80	4950009	2x4070000	1x4960005	1x4070000	1x4070030	5910006	5940101	5940001	5930003
1917059	6,5	276	100	4950010	2x4070000	1x4960006	1x4070000	1x4070030	5910006	5940101	5940001	5930003

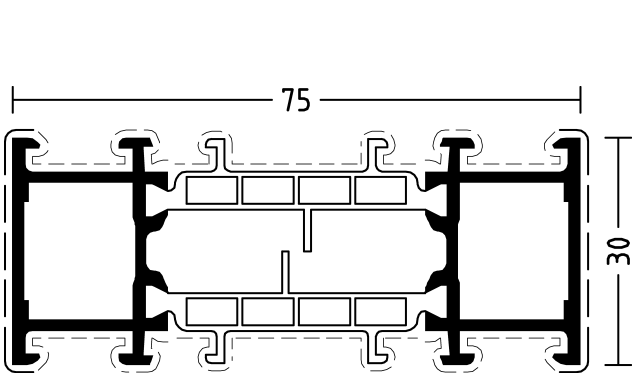



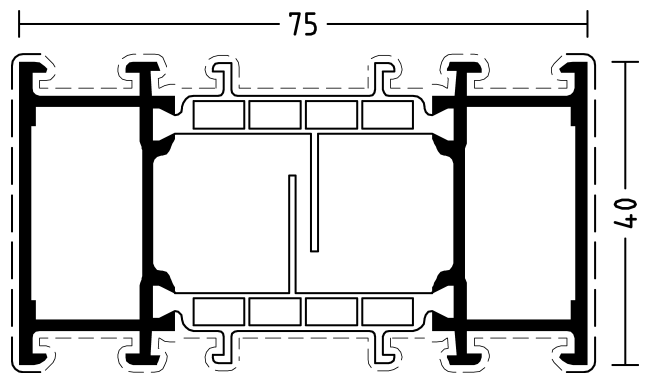



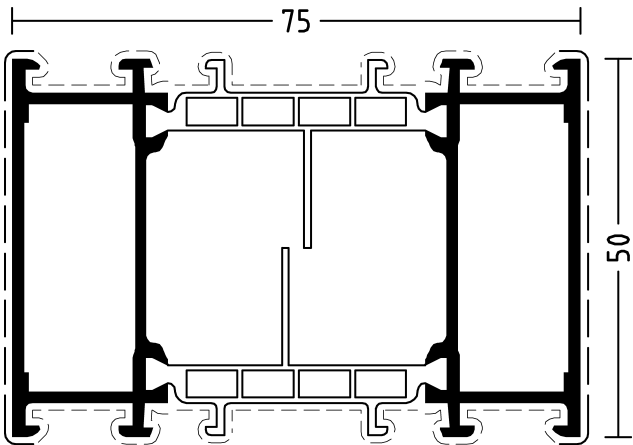



1917057



1917058







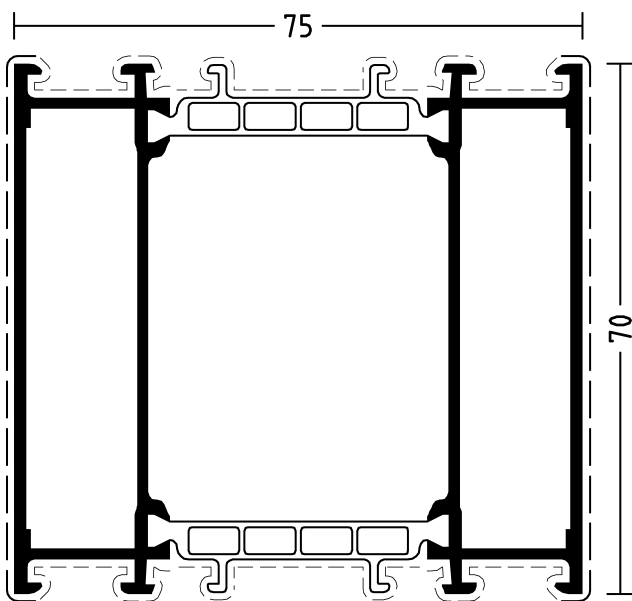









1917059

 m mm mm	 		  			   			
	1917060 6,5 316 140	-	-	1x4960008	2x4070000	2x4070030	5910006	5940101	5940001
	-	-	1x4960008	2x4070000	2x4070030	5910006	5940101	5940001	5930003



1917060





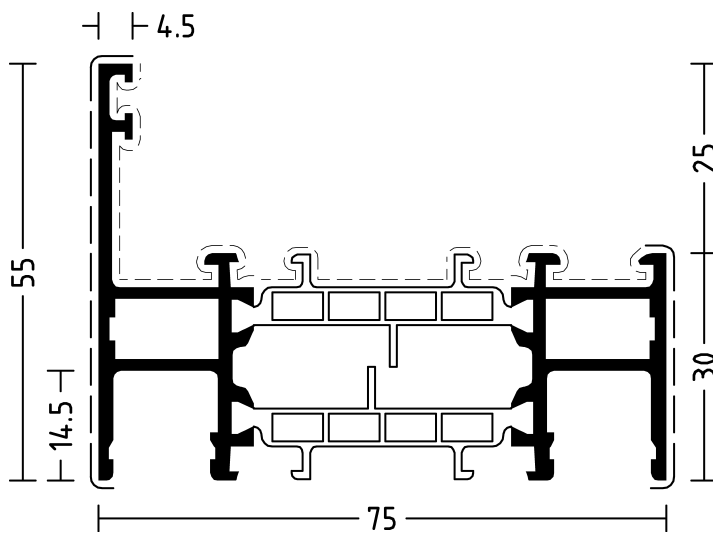









Eckverbindung außen:
 Zuschnitt aus 3900040 oder 3900053 (13.20) + 2x 4070000
 Eckverbindung innen:
 Zuschnitt aus 3900040 oder 3900053 (13.20) + 2x 4070000
 Corner connection outside:
 Cutting with 3900040 or 3900053 (13.20) + 2x 4070000
 Corner connection inside:
 Cutting with 3900040 or 3900053 (13.20) + 2x 4070000

												
	m	mm	mm									
 1917062	6,5	330	85	4950005	2x4070009	-	-	-	5910006	-	-	5930003
				4950005	2x4070009	-	-	-	5910006	-	-	5930003



1917062

Gelenckwinkel und Gelenkverbinder siehe Zusatzartikel.
See additional articles for hinged corner angles and hinged connectors.

	 m	 mm	 mm									
 1917064	6,5	350	105	4950008	2x4070000	1x4960004	1x4070000	1x4070030	5910006	5940101	5940001	5930003
				4950008	2x4070000	1x4960004	1x4070000	1x4070030	5910006	5940101	5940001	5930003

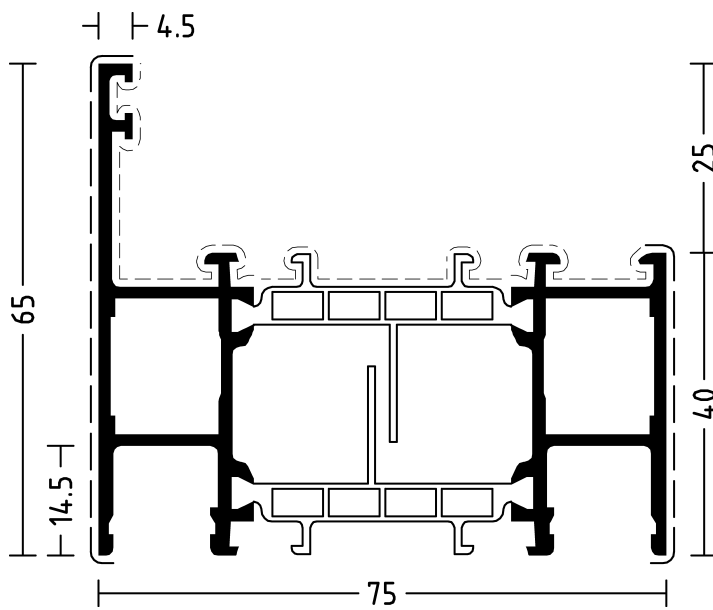



1917064

Gelenkeckwinkel und Gelenkverbinder siehe Zusatzartikel.
See additional articles for hinged corner angles and hinged connectors.



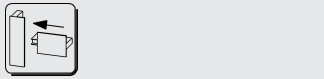
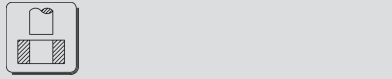

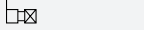

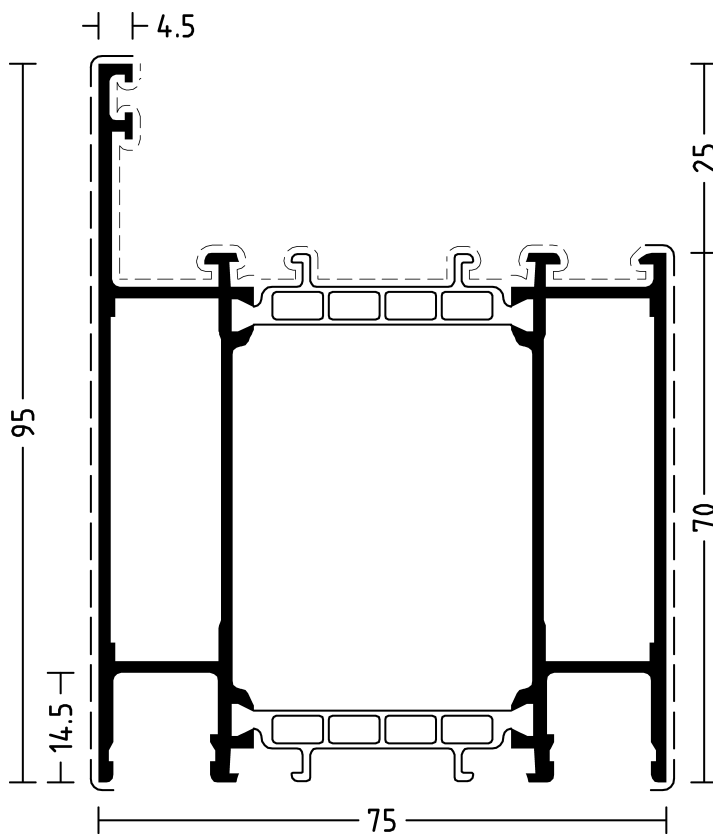























WICSTYLE 75 evo

Blendrahmenprofile Frame profiles

	m	mm	mm									
 1917067	6,5	410	165	4950011	2x4070000	1x4960007	2x4070000	2x4070030	5910006	5940101	5940001	5930003
				4950011	2x4070000	1x4960007	2x4070000	2x4070030	5910006	5940101	5940001	5930003







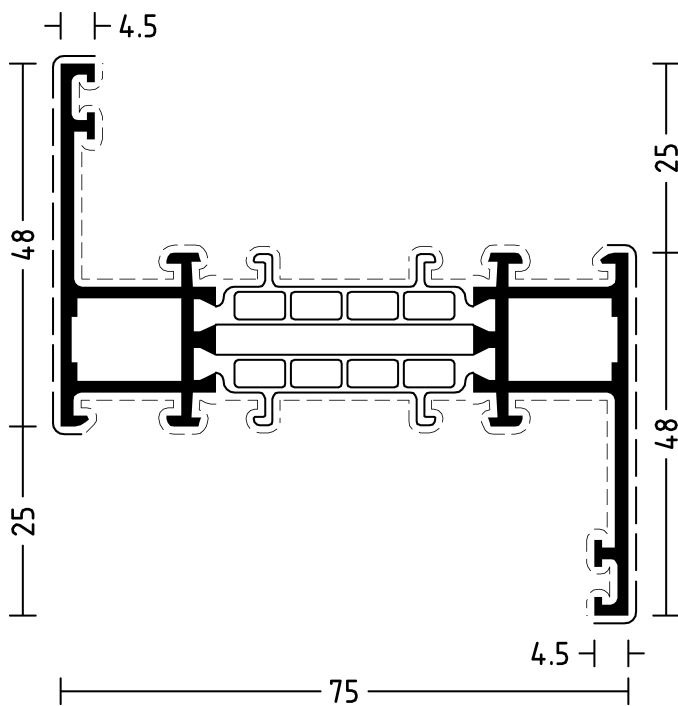









1917067

													
	m	mm	mm										
 1917068	6,5	347	96	 4950006	 2x4070000	 1x4960002	 1x4070000	-	 5910006	 5940101	 5940001	 5930003	
				 4950006	 2x4070000	 1x4960002	 1x4070000	-	 5910006	 5940101	 5940001	 5930003	



1917068



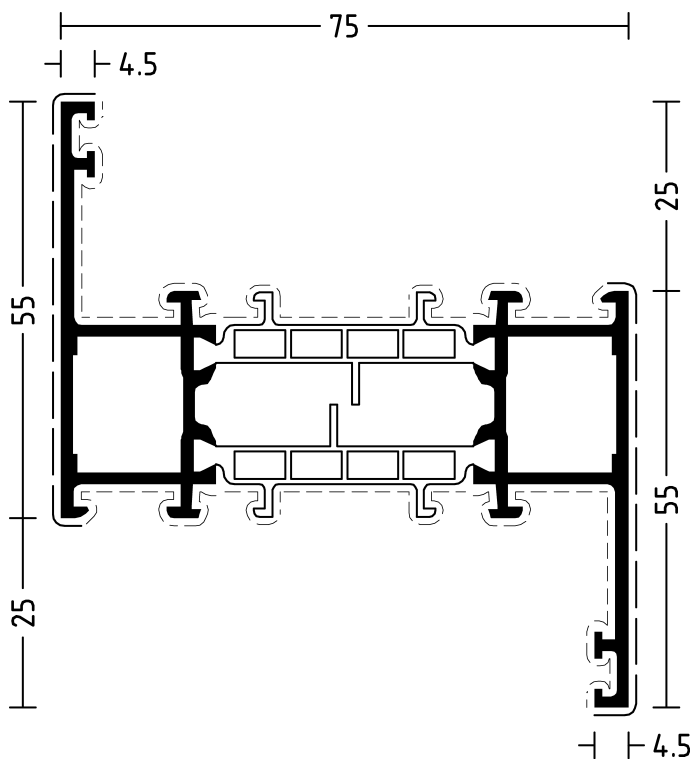

Gelenkeckwinkel und Gelenkverbinder siehe Zusatzartikel.
See additional articles for hinged corner angles and hinged connectors.

												
	m	mm	mm									
 1917069	6,5	361	110	4950008	2x4070000	1x4960004	1x4070000	1x4070030	5910006	5940101	5940001	5930003
				4950008	2x4070000	1x4960004	1x4070000	1x4070030	5910006	5940101	5940001	5930003

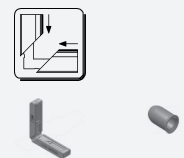

1917069

Gelenkeckwinkel und Gelenkverbinder siehe Zusatzartikel.
See additional articles for hinged corner angles and hinged connectors.

	m	mm	mm									
 1917073	6,5	361	110	4950008	2x4070000	1x4960004	1x4070000	1x4070030	5910006	5940101	5940001	5930003
				4950008	2x4070000	1x4960004	1x4070000	1x4070030	5910006	5940101	5940001	5930003
1917076	6,5	322	70	4950013	2x4070008	-	-	-	5910016	5940107	5940010	5930010
				4950006	2x4070008	-	-	-	5910016	5940101	5940010	5930010

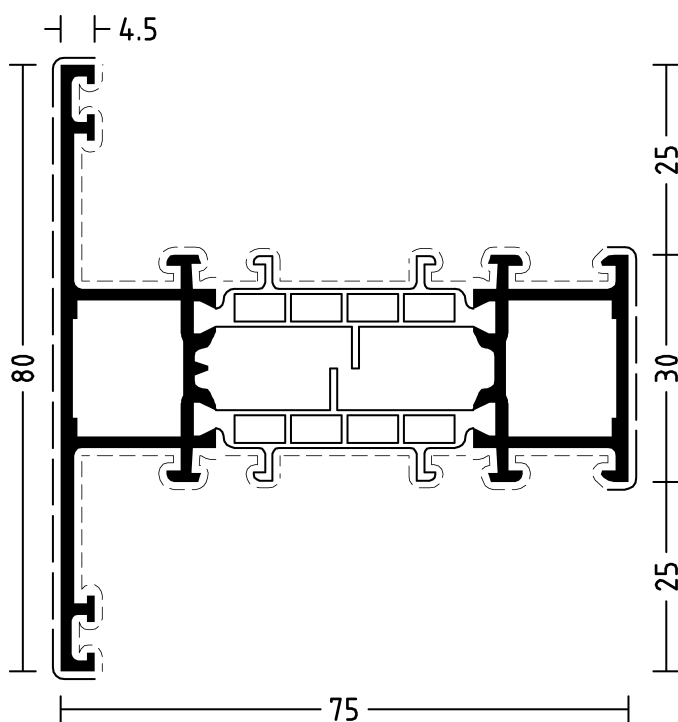





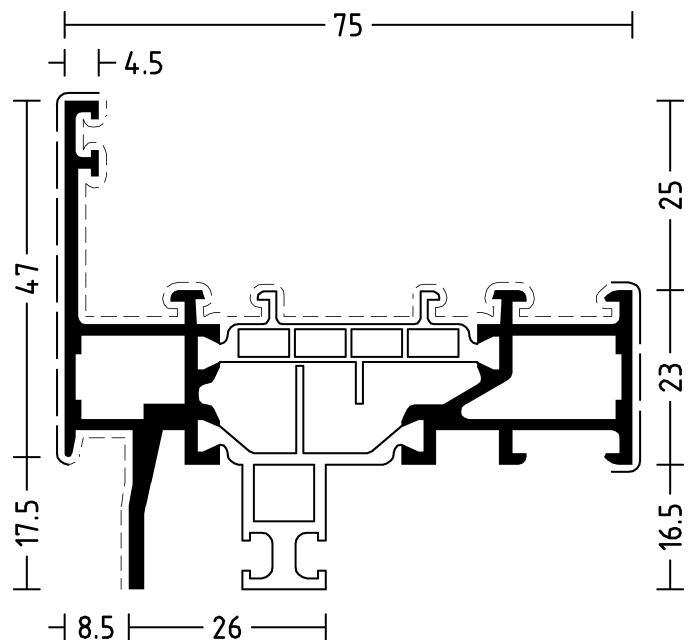









1917073

Gelenckwinkel und Gelenkverbinder siehe Zusatzartikel.
See additional articles for hinged corner angles and hinged connectors.



1917076

Einspannblendrahmen
Clamping Frame

												
 1917077	6,5	336	84	4950014	2x4070008	-	-	-	5910016	5940107	5940010	5930010
				4950008	2x4070008	-	-	-	5910016	5940101	5940010	5930010
1017077	6,5	321	84	4950014	2x4070008	-	-	-	5910016	5940107	5940010	5930010
				4950008	2x4070008	-	-	-	5910016	5940101	5940010	5930010

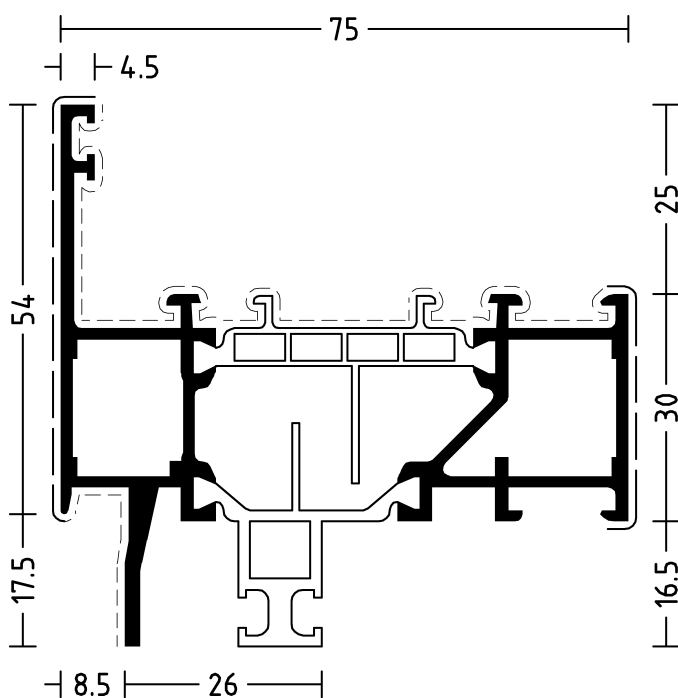

1917077

Einspannblendrahmen
Clamping frame

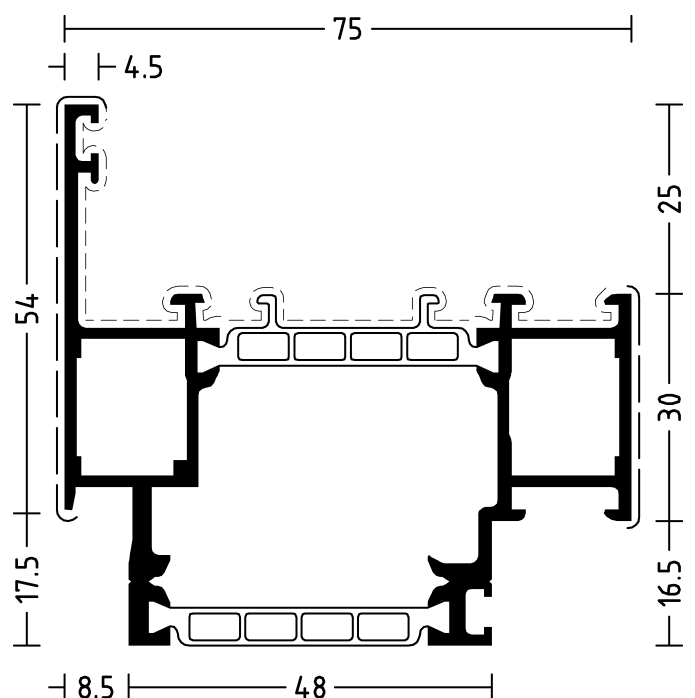















1017077

Einspannblendrahmen
Clamping frame

WICSTYLE 75 evo

Blendrahmenprofile Frame profiles

	 m	 mm	 mm									
 1010425	6,5	387	119	4950006	1x4070000	1x4960035	1x4070000	-	5910006	5940101	5940001	5930003
				4950006	1x4070000	1x4960002	1x4070000	-	5910006	5940101	5940001	5930003
1927500	6,5	298	100	4950008	2x4070000	-	-	-	5910006	5940101	5940001	5930003
				4950008	2x4070000	-	-	-	5910006	5940101	5940001	5930003

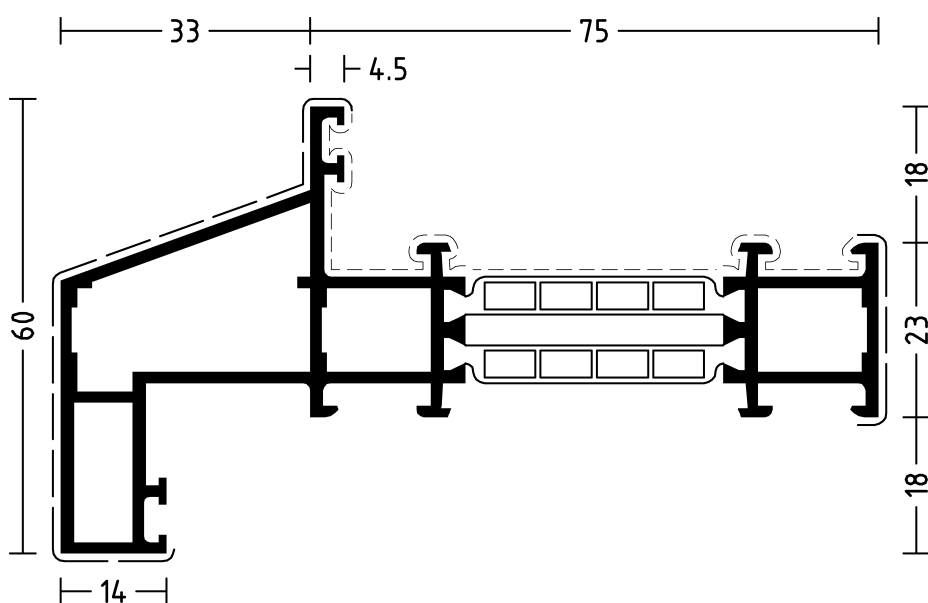



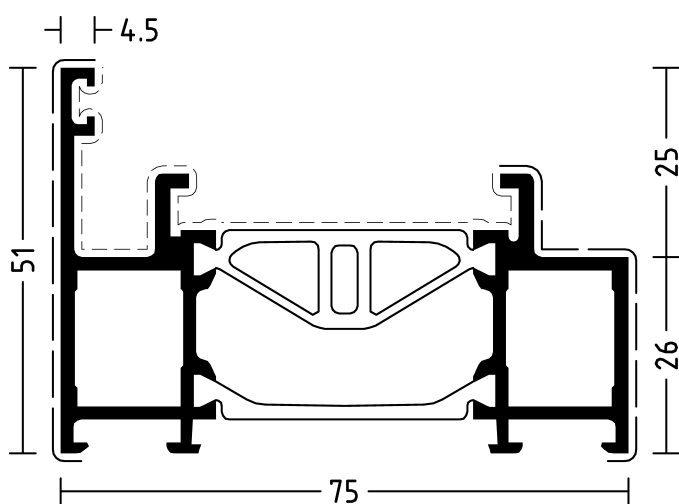











1010425



1927500

WICSTYLE 75 evo

Blendrahmenprofile Frame profiles

	 m	 mm	 mm									
 1927501	6,5	326	128	4950015	2x4070000	-	-	-	5910006	5940101	5940001	5930003
				4950015	2x4070000	-	-	-	5910006	5940101	5940001	5930003
1927502	6,5	338	140	4950010	2x4070000	-	-	-	5910006	5940101	5940001	5930003
				4950010	2x4070000	-	-	-	5910006	5940101	5940001	5930003

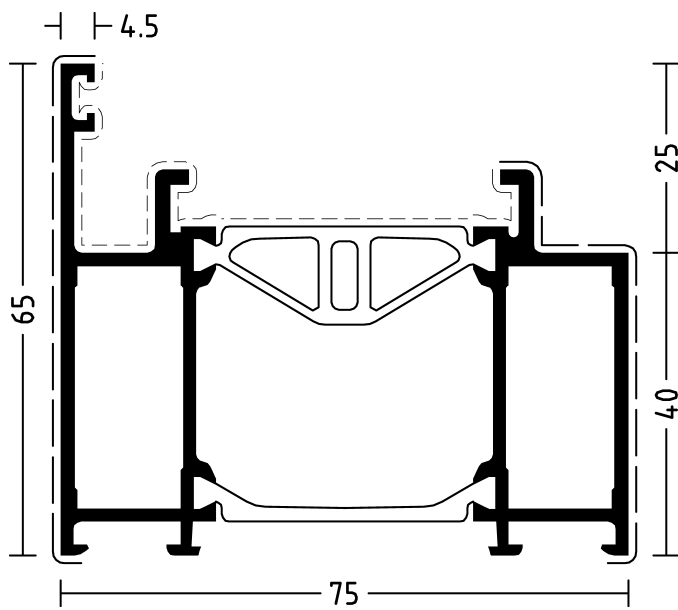



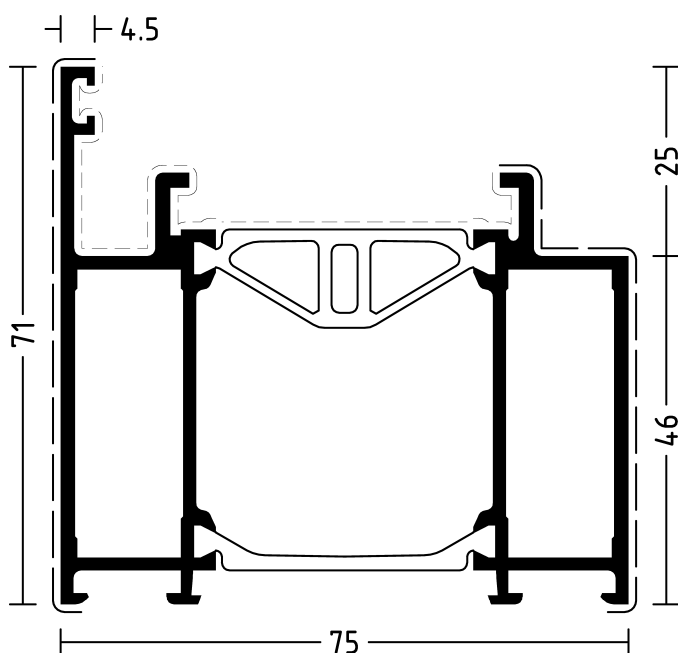











1927501



1927502

WICSTYLE 75 evo





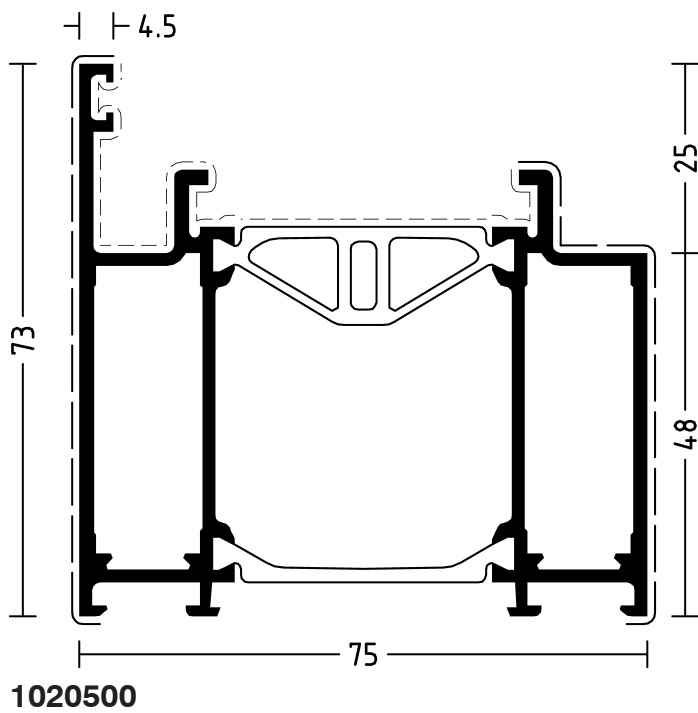









Blendrahmenprofile Frame profiles

												
	m	mm	mm									
 1020500	6,5	342	144	4950058	2x4070000	-	-	-	5910020	5940110	5940049	5930003
				4950058	2x4070000	-	-	-	5910020	5940110	5940049	5930003







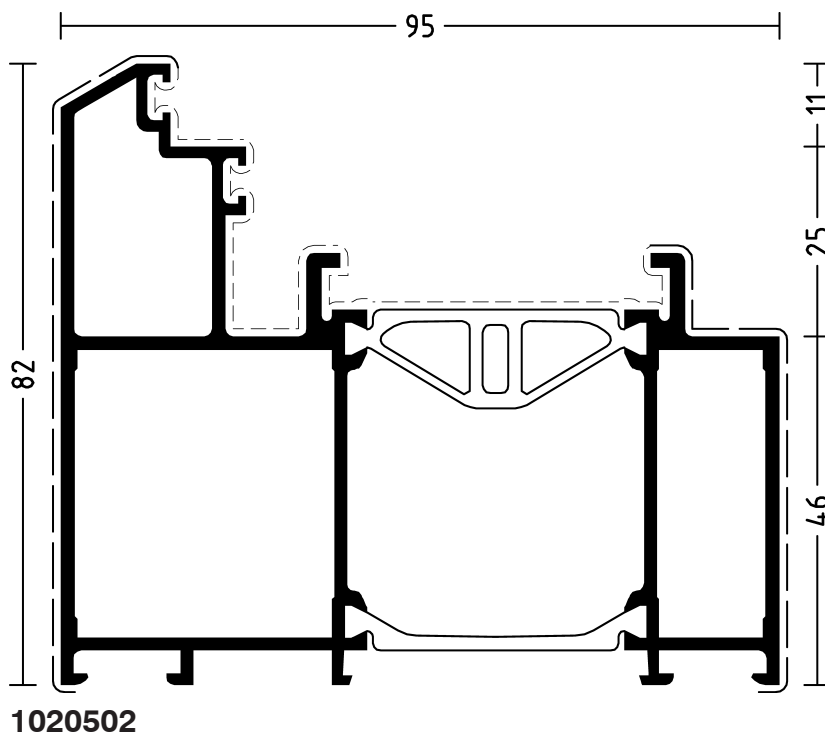

WICSTYLE 75 evo









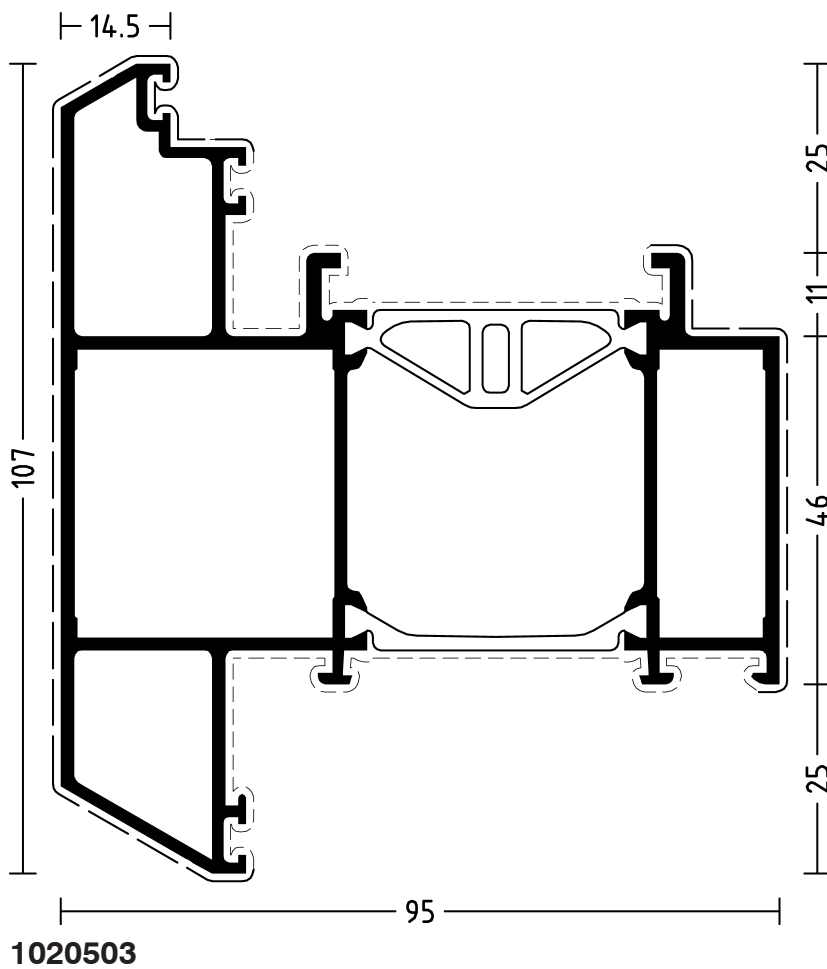





Blendrahmenprofile Frame profiles

												
	m	mm	mm									
 1020502	6,5	413	157	4050591	2x4070000	-	-	-	5910006	5940101	5940001	5930003
				4950010	2x4070000	-	-	-	5910006	5940101	5940001	5930003









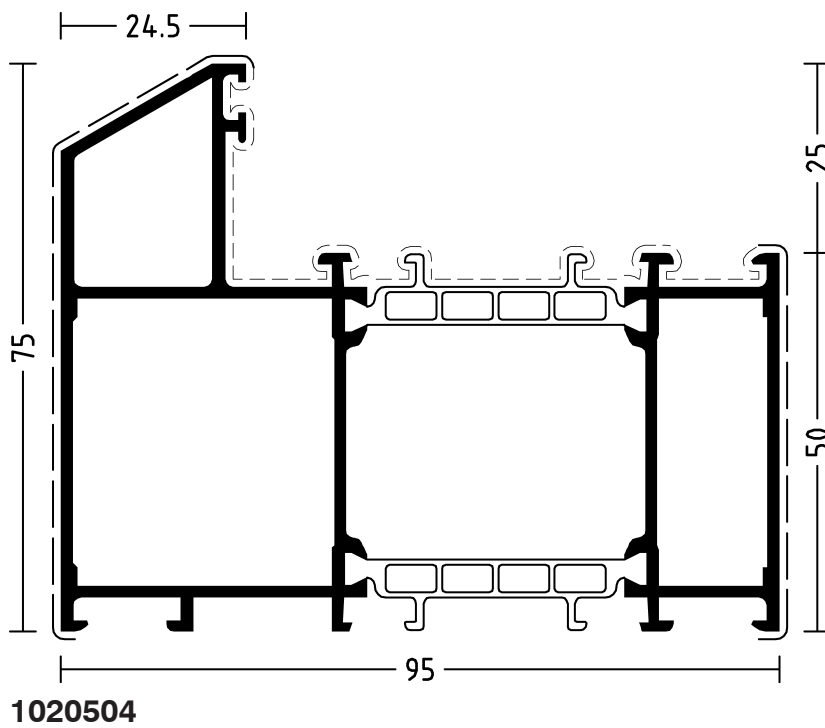



	 m	 mm	 mm									
 1020503	6,5	459	193	4050591	2x4070000	1x4960006	1x4070000	1x4070030	5910006	5940101	5940001	5930003
				4950010	2x4070000	1x4960006	1x4070000	1x4070030	5910006	5940101	5940001	5930003



												
	m	mm	mm									
 1020504	6,5	379	136	4050591	2x4070000	1x4960006	1x4070000	1x4070030	5910006	5940101	5940001	5930003
				4950010	2x4070000	1x4960006	1x4070000	1x4070030	5910006	5940101	5940001	5930003



	m	mm	mm									
 1927506	6,5	313	85	4950013	2x4070008	-	-	-	5910016	5940107	5940010	5930010
				4950006	2x4070008	-	-	-	5910016	5940101	5940010	5930010
1927507	6,5	313	85	4950013	2x4070008	-	-	-	5910016	5940107	5940010	5930010
				4950006	2x4070008	-	-	-	5910016	5940101	5940010	5930010

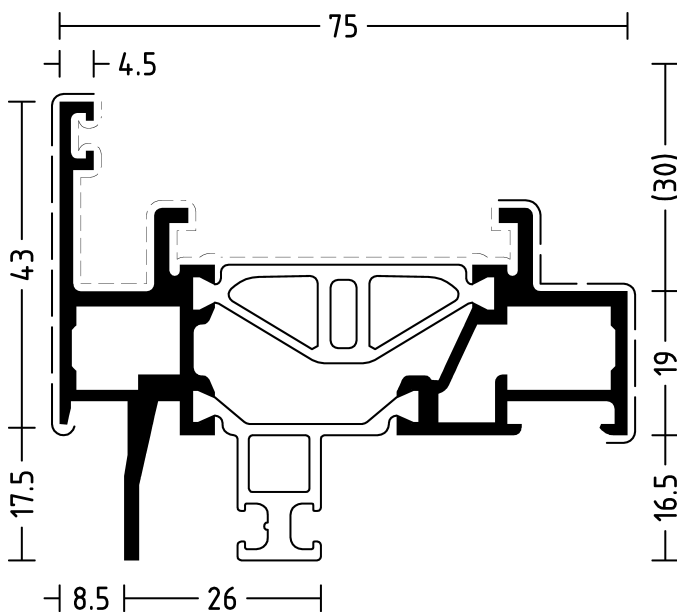





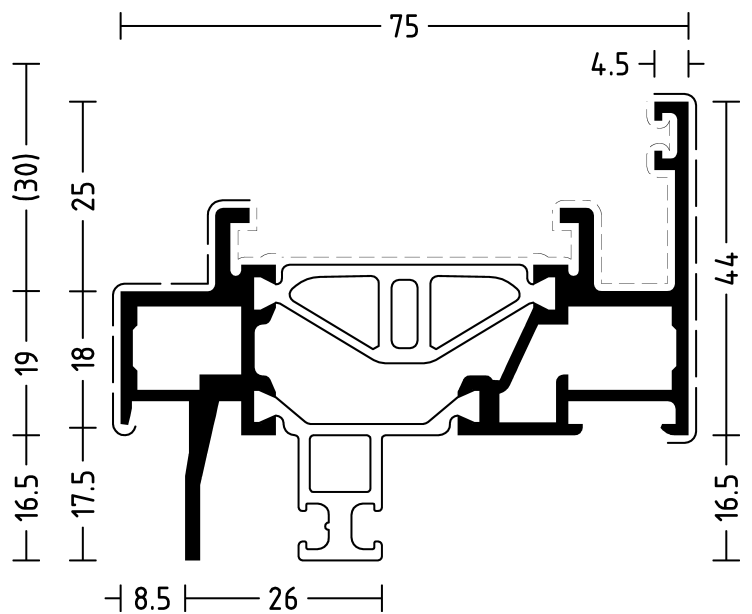









1927506

Einspannblendrahmen für Fassade/Rollenband
einwärts öffnend
Clamping frame for façade/butt hinge
inward opening



1927507





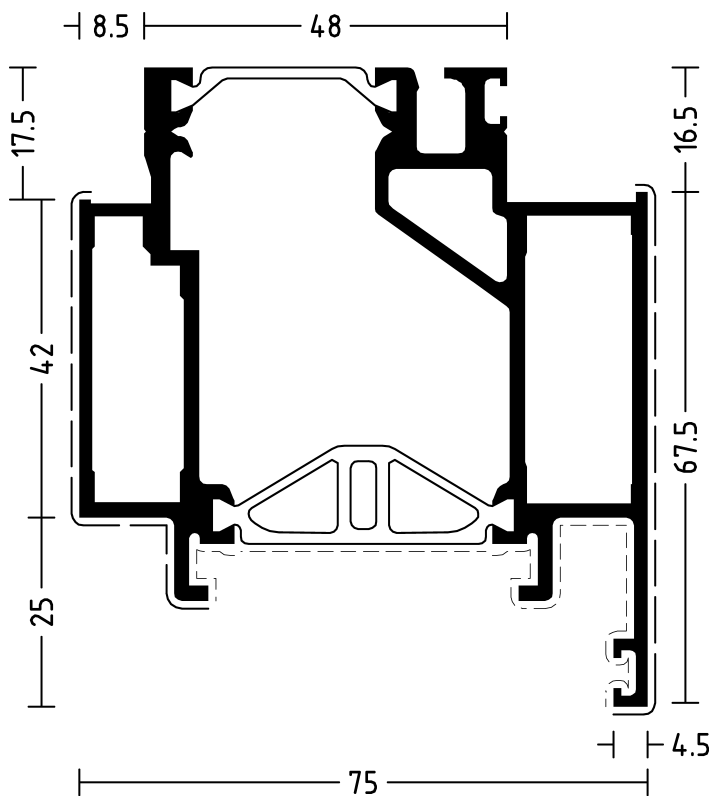









Einspannblendrahmen für Fassade/Rollenband
auswärts öffnend
Clamping frame for façade/butt hinge
outward opening

	 m	 mm	 mm										
 1020512	6,5	374	133	4950021	2x4070000	-	-	-	5910016	5940107	-	-	
				4950010	2x4070000	-	-	-	5910016	5940107	-	-	



1020512





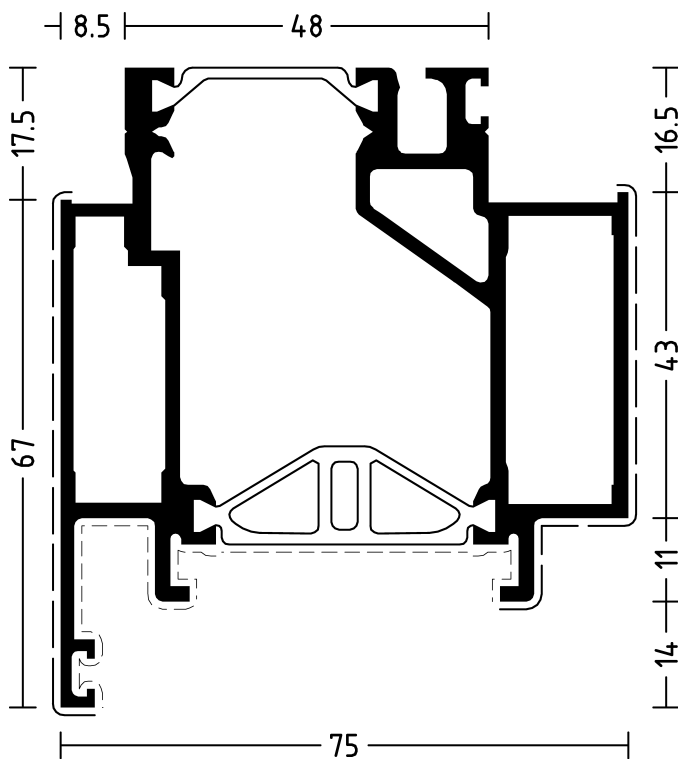









Einspannblendrahmen für Fassade
auswärts öffnend
Clamping frame for façade
outward opening

													
	m	mm	mm										
 1020513	6,5	374	133	4950021	2x4070000	-	-	-	5910016	5940107	-	-	-
				4950010	2x4070000	-	-	-	5910016	5940107	-	-	-



1020513

Einspannblendrahmen für Fassade
einwärts öffnend
Clamping frame for façade
inward opening

	 m	 mm	 mm									
 1927516	6,5	433	189	-	-	1x4960064	2x4070000	2x4070030	5910006	5940101	5940001	-
 1927516	-	-	-	-	-	1x4960014	2x4070000	2x4070030	5910006	5940101	5940001	-
1927517	6,5	453	209	-	-	1x4960065	2x4070000	2x4070030	5910006	5940101	5940001	-
	-	-	-	-	-	1x4960015	2x4070000	2x4070030	5910006	5940101	5940001	-

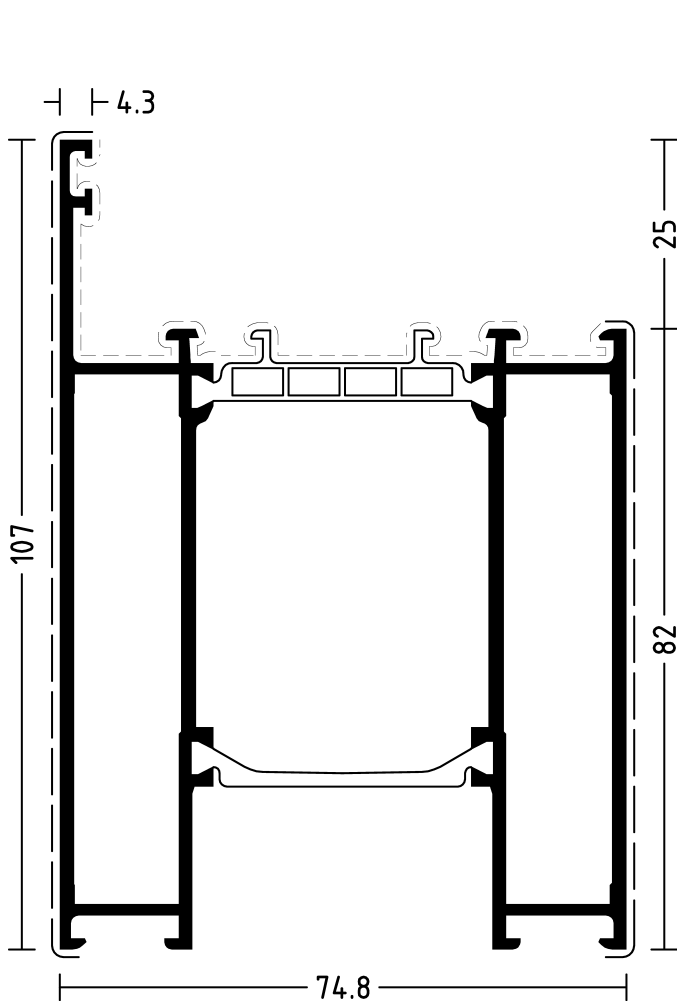





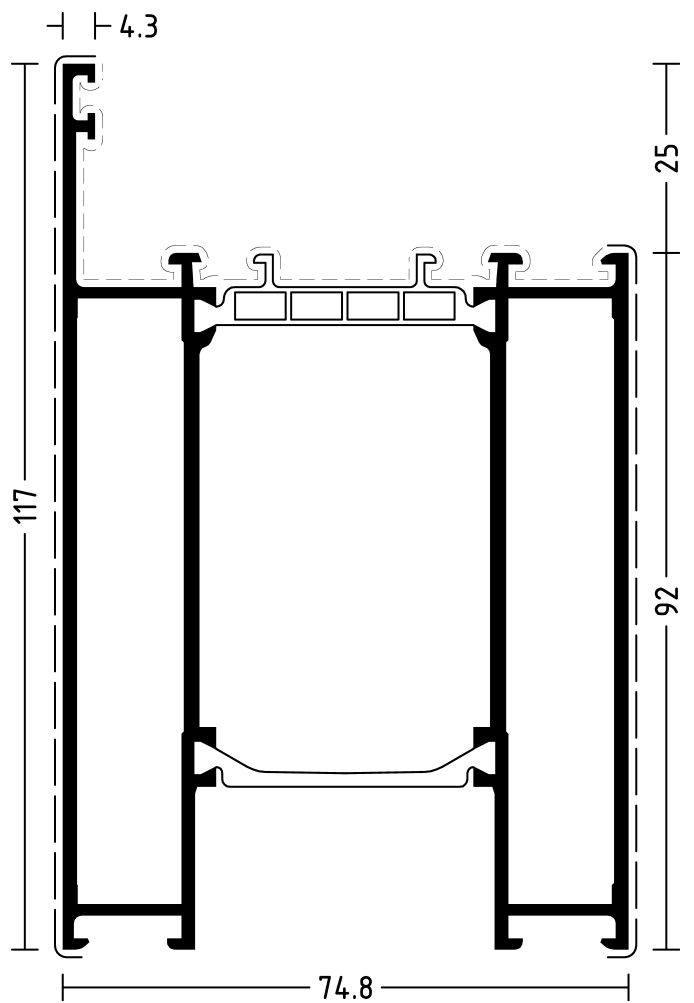









1927516

Stoßverbindungen mit Blendrahmenprofilen (Festfeld) Verbinder 4960014 (außen).
Butt joint connections with frame profiles (fixed field), connector 4960014 (outside).



1927517

Stoßverbindungen mit Blendrahmenprofilen (Festfeld) Verbinder 4960015 (außen).
Butt joint connections with frame profiles (fixed field), connector 4960015 (outside).

												
	m	mm	mm									
 1020508	6,5	473	229	-	-	1x4060413	2x4070000	2x4070030	5910006	5940101	5940001	-
				-	-	1x4060411	2x4070000	2x4070030	5910006	5940101	5940001	-
1927518	6,5	513	269	-	-	1x4960066	2x4070000	2x4070030	5910006	5940101	5940001	-
				-	-	1x4960016	2x4070000	2x4070030	5910006	5940101	5940001	-

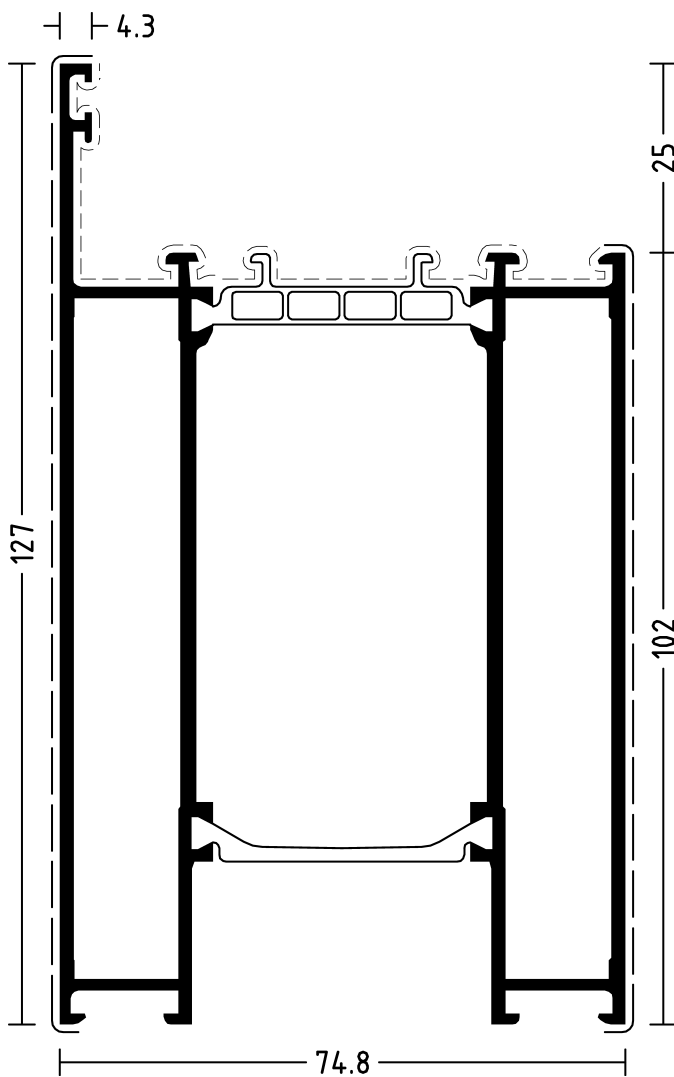

1020508

Stoßverbindungen mit Blendrahmenprofilen (Festfeld) Verbinder 4060411 (außen).
Butt joint connections with frame profiles (fixed field), connector 4060411 (outside).

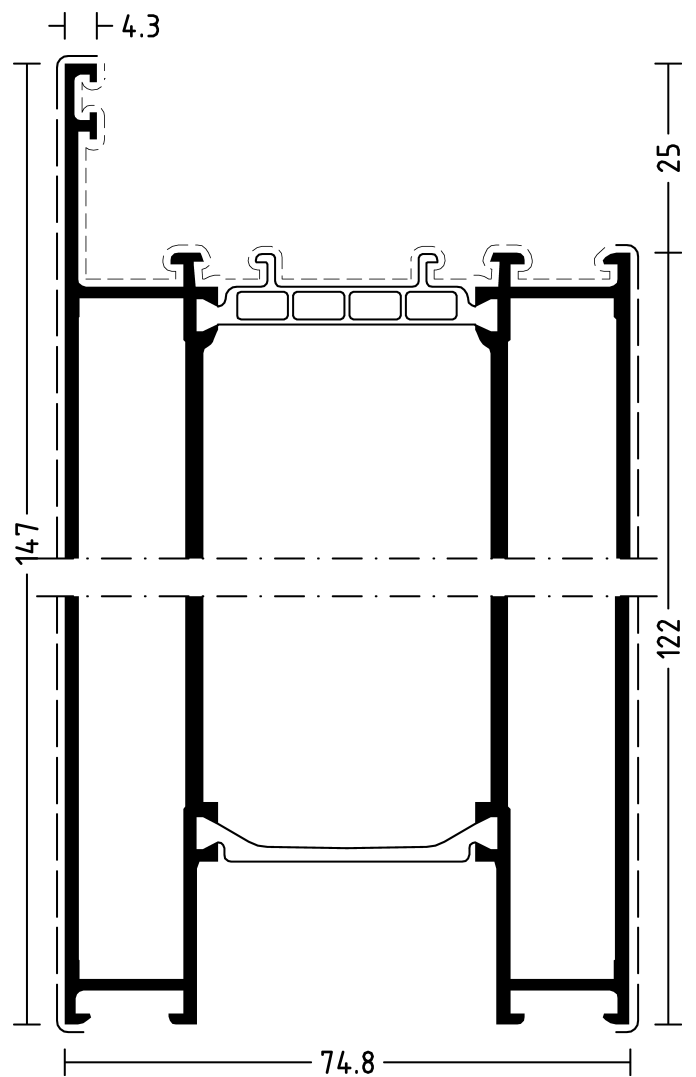















1927518

Stoßverbindungen mit Blendrahmenprofilen (Festfeld) Verbinder 4960016 (außen).
Butt joint connections with frame profiles (fixed field), connector 4960016 (outside).

WICSTYLE 75 evo

Sockelprofile Bottom rail profiles



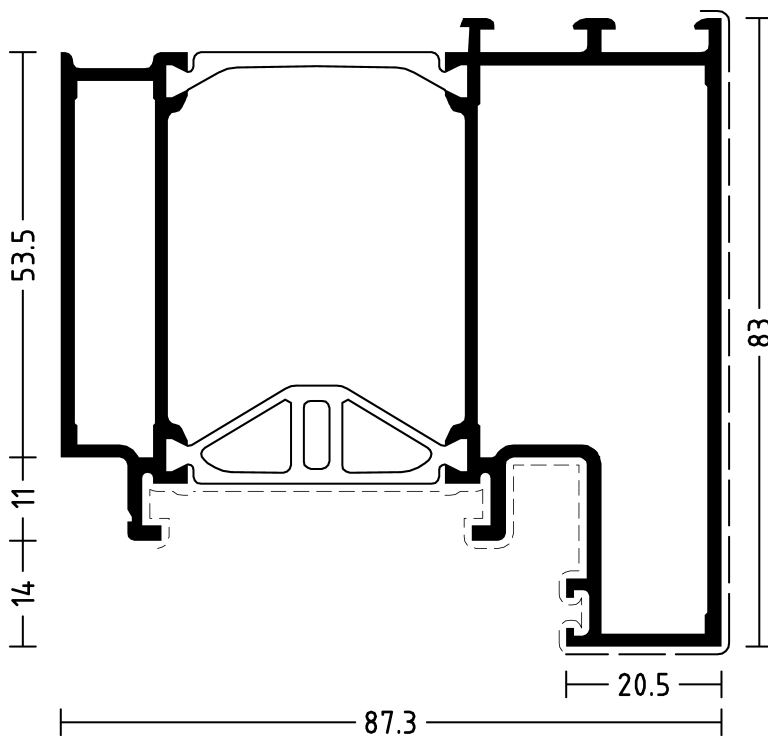











												
	m	mm	mm									
 1020533	6,5	380	83	4950328	2x4070000	-	-	-	5910077	5940107	-	5930031
				4950352	2x4070000	-	-	-	5910077	5940112	-	5930031











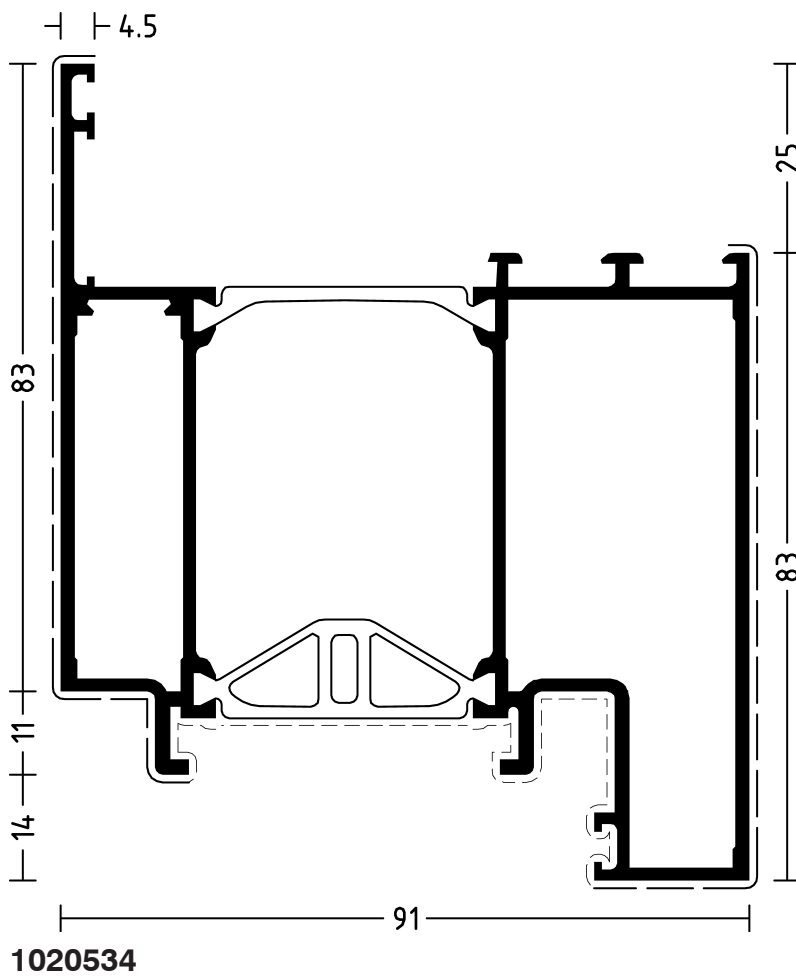





1020533

WICSTYLE 75 evo

Sockelprofile
Bottom rail profiles

												
	m	mm	mm									
 1020534	6,5	461	189	4950059	2x4070000	-	-	-	5910024	5940112	5940049	5930003
				4950352	2x4070000	-	-	-	5910024	5940112	5940049	5930003





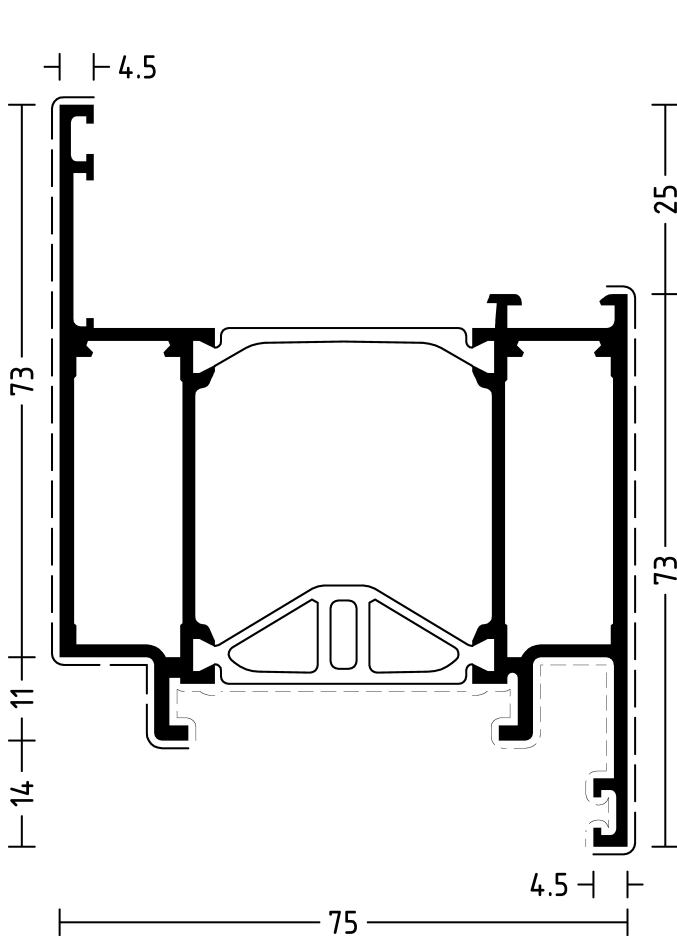



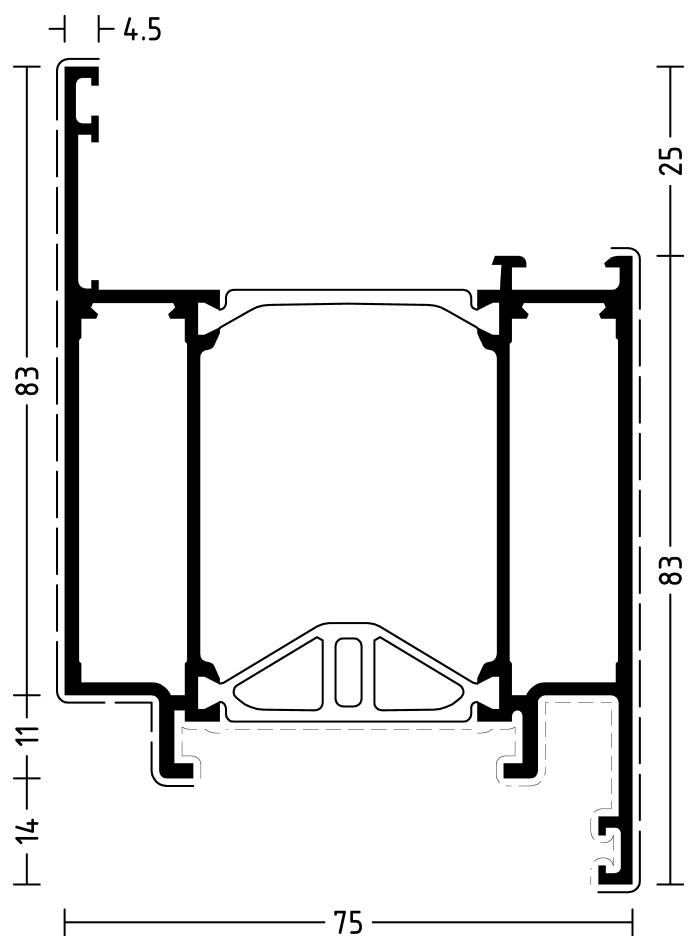



	 m	 mm	 mm									
 1927510	6,5	394	169	4950058	2x4070000	-	-	-	5910024	5940112	5940049	5930003
 1927511	6,5	414	189	4950058	2x4070000	-	-	-	5910024	5940112	5940049	5930003
1927510				4950059	2x4070000	-	-	-	5910024	5940112	5940049	5930003
				4950059	2x4070000	-	-	-	5910024	5940112	5940049	5930003



1927510
 nach innen öffnend
 inward opening



1927511
 nach innen öffnend
 inward opening



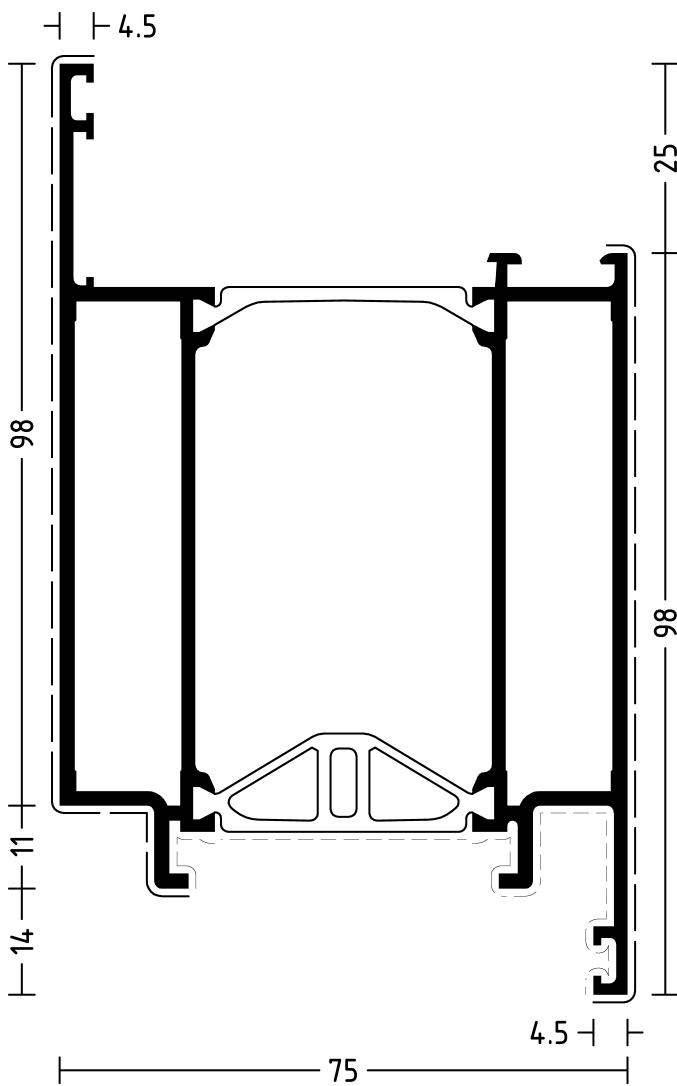



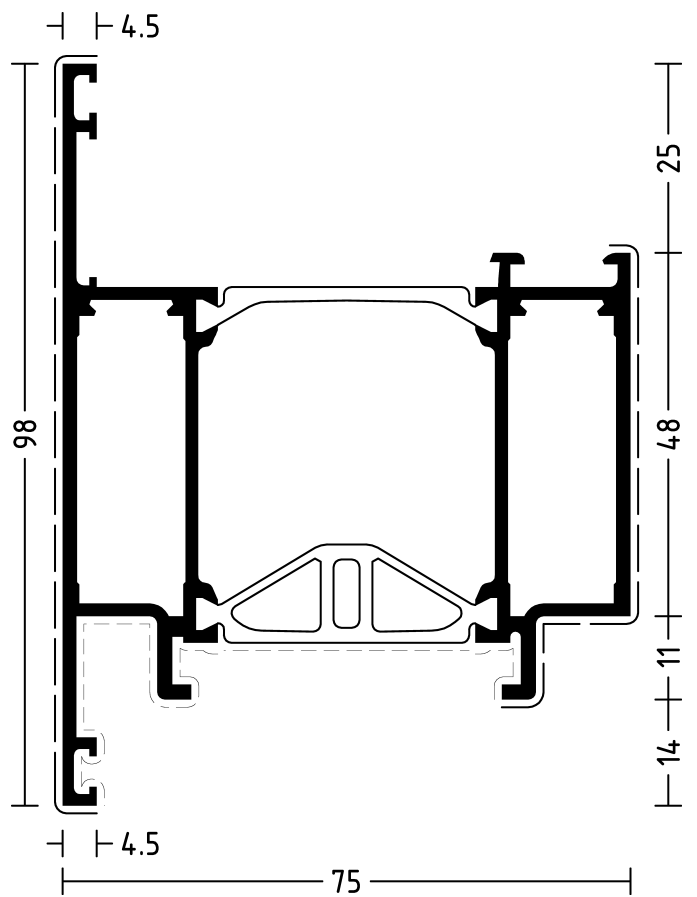





	m	mm	mm									
 1927512	6,5	444	219	4950016	2x4070000	-	-	-	5910024	5940112	5940049	5930003
				4950016	2x4070000	-	-	-	5910024	5940112	5940049	5930003
1927513	6,5	394	169	4950058	2x4070000	-	-	-	5910024	5940112	5940049	5930003
				4950058	2x4070000	-	-	-	5910024	5940112	5940049	5930003



1927512
 nach innen öffnend
inward opening



1927513
 nach außen öffnend
outward opening

		m	mm	mm									
 1927514	6,5	414	189	4950059	2x4070000	-	-	-	5910024	5940112	5940049	5930003	
 1927515	6,5	444	219	4950059	2x4070000	-	-	-	5910024	5940112	5940049	5930003	
				4950016	2x4070000	-	-	-	5910024	5940112	5940049	5930003	
				4950016	2x4070000	-	-	-	5910024	5940112	5940049	5930003	

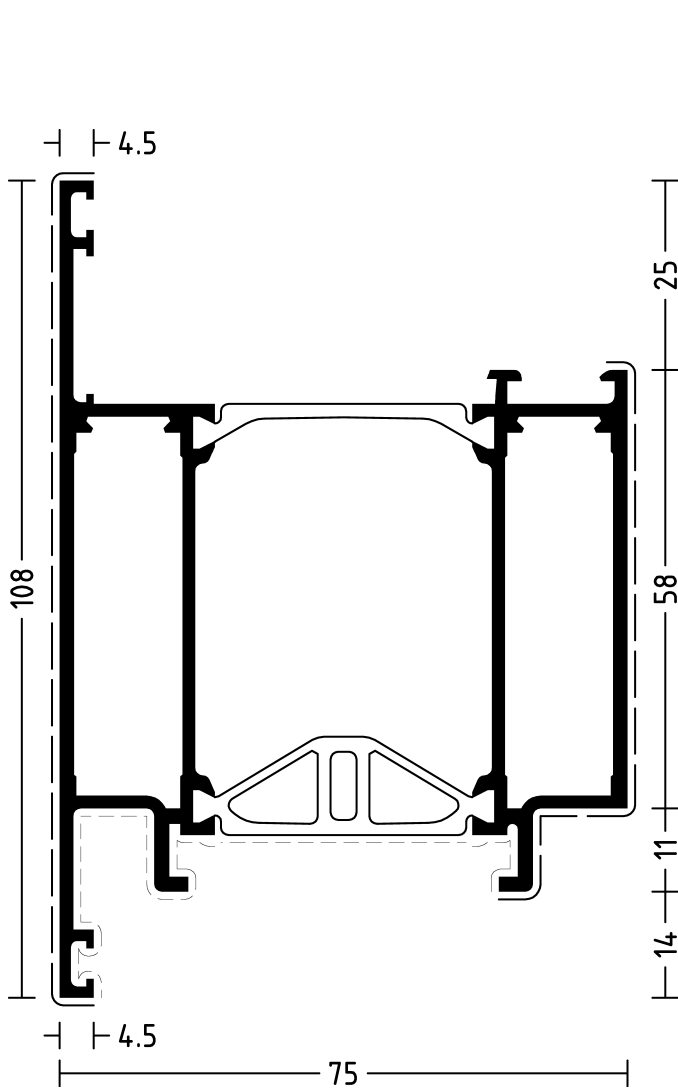

1927514

nach außen öffnend
outward opening

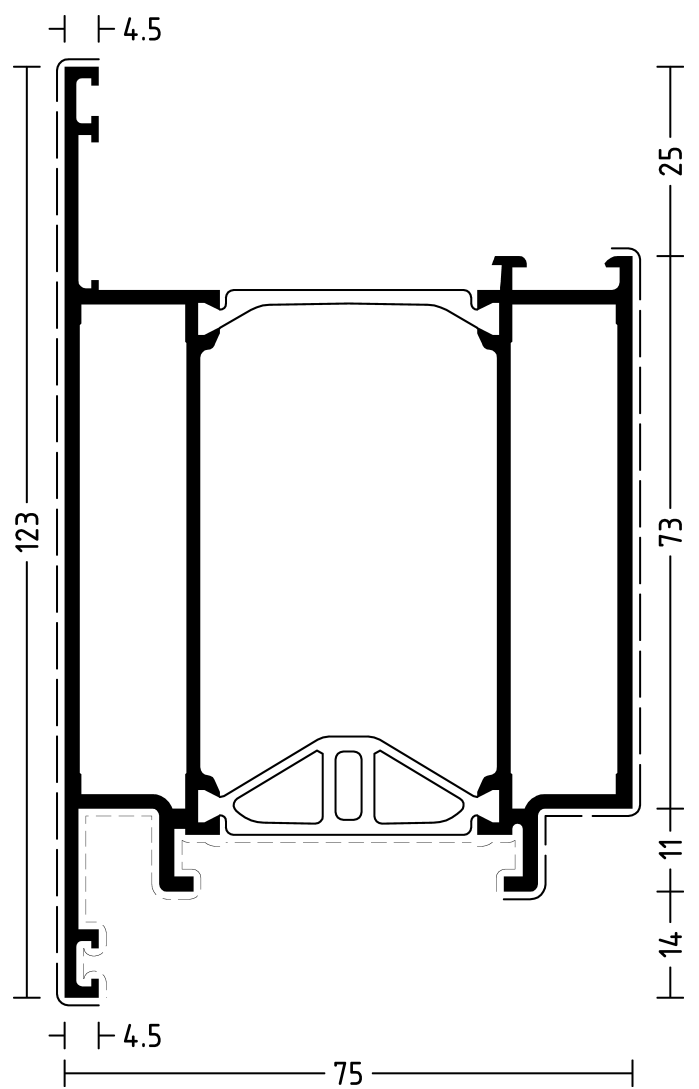

1927515

nach außen öffnend
outward opening

WICSTYLE 75 evo





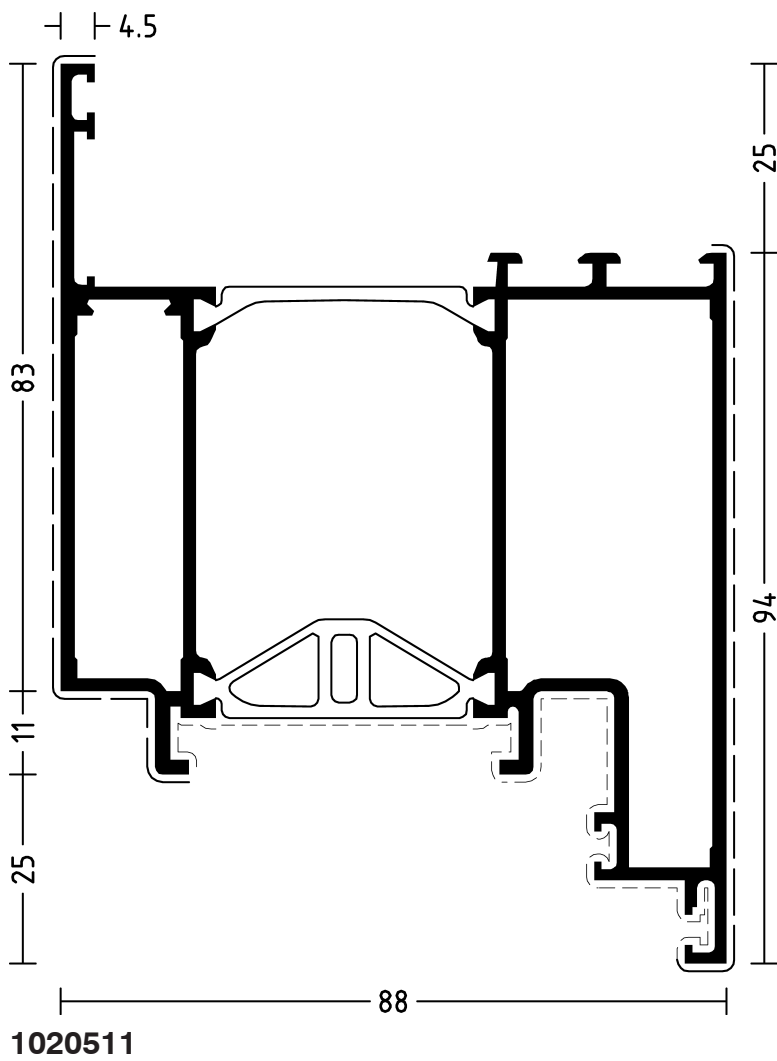









Flügelprofile Sash profiles

Icon	m	mm	mm	Icon 1		Icon 2			Icon 3				
				4950059	2x4070000	-	-	-	5910024	5940112	5940049	5930003	
☒	1020511	6,5	494	200	4950059	2x4070000	-	-	-	5910024	5940112	5940049	5930003
☒					4050587	2x4070000	-	-	-	5910024	5940112	5940049	5930003



WICSTYLE 75 evo





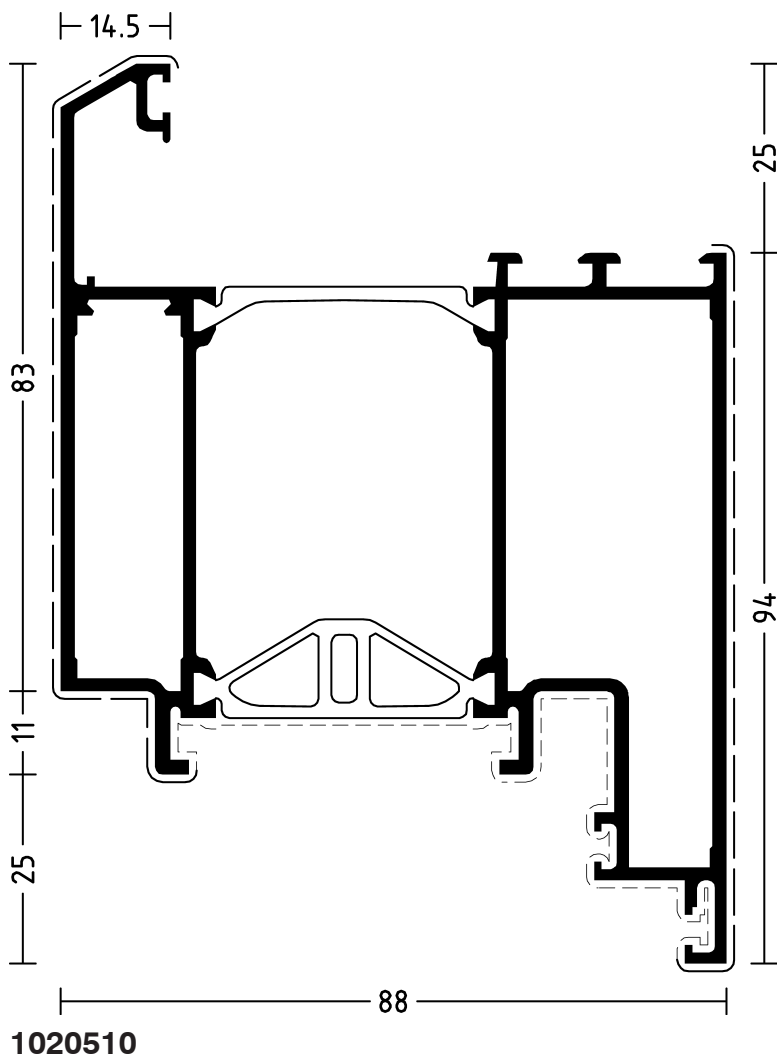









Flügelprofile Sash profiles

	 m	 mm	 mm									
 1020510	6,5	520	183	4950059	2x4070000	-	-	-	5910024	5940112	5940049	5930003
				4050587	2x4070000	-	-	-	5910024	5940112	5940049	5930003









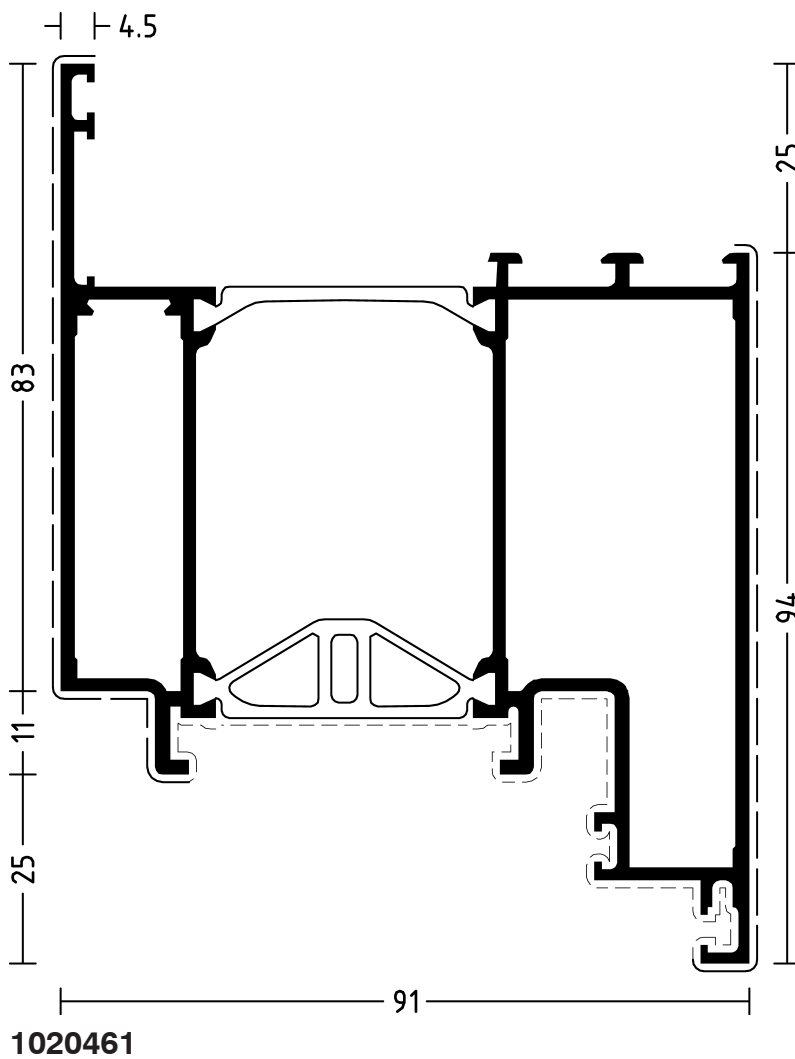







WICSTYLE 75 evo









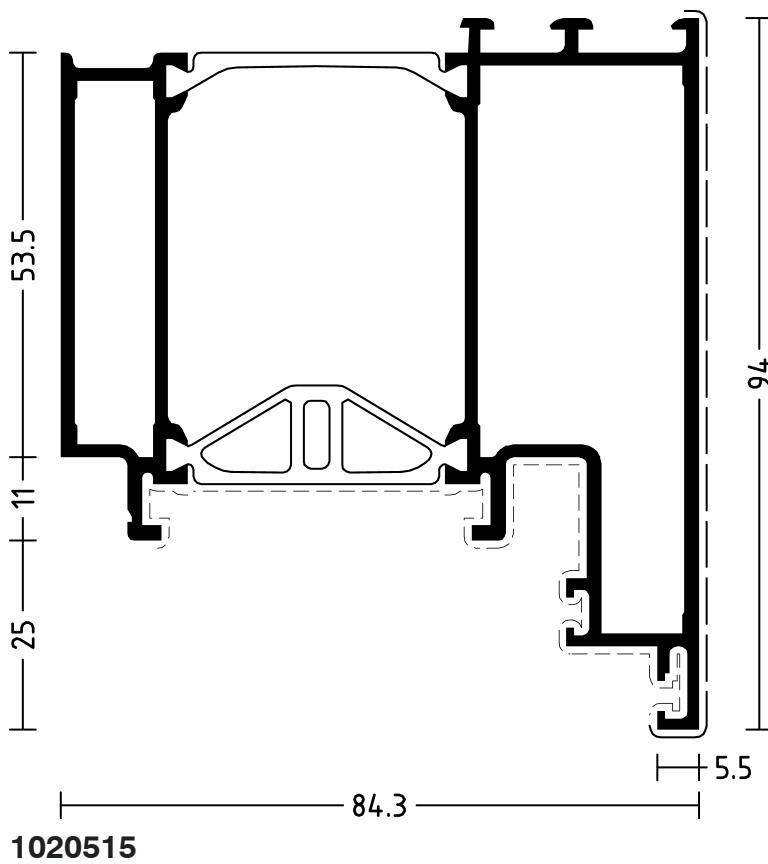





Flügelprofile Sash profiles

												
	m	mm	mm									
 1020461	6,5	502	200	4950059	2x4070000	-	-	-	5910024	5940112	5940049	5930003
				4950352	2x4070000	-	-	-	5910024	5940112	5940049	5930003









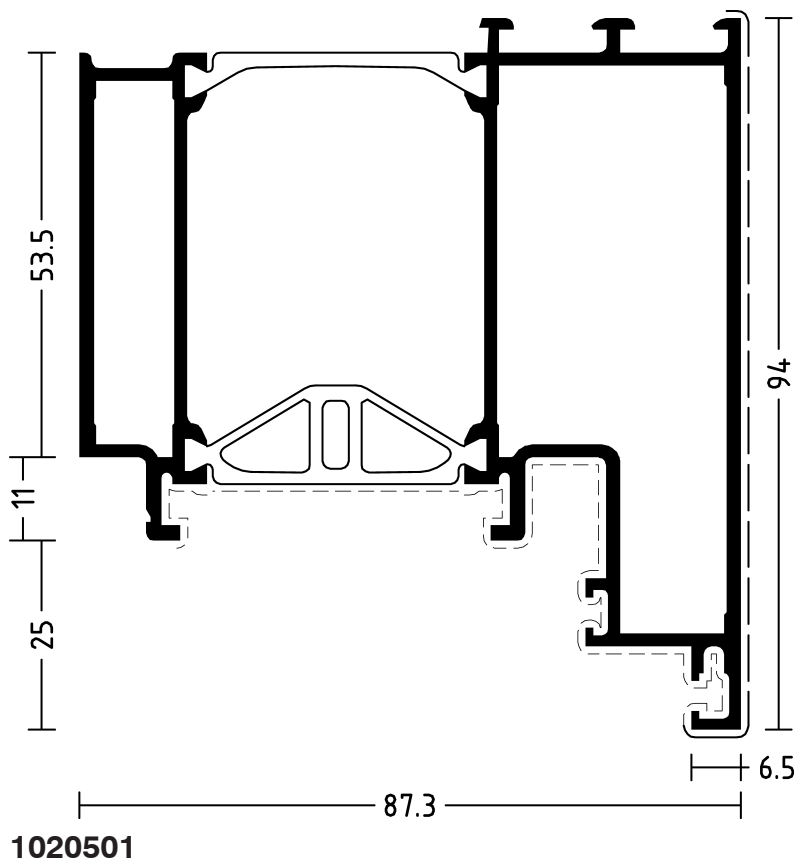







												
	m	mm	mm									
 1020515	6,5	415	94	4950328	2x4070000	-	-	-	5910077	5940107	-	5930031
				4050587	2x4070000	-	-	-	5910077	5940112	-	5930031



												
	m	mm	mm									
 1020501	6,5	415	94	4950328	2x4070000	-	-	-	5910077	5940107	-	5930031
				4950352	2x4070000	-	-	-	5910077	5940112	-	5930031



												
	m	mm	mm									
 1920513	6,5	241	0	4950328	2x4070000	-	-	-	5910077	5940107	-	5930031
				4950328	2x4070000	-	-	-	5910077	5940107	-	5930031
1920517	6,5	333	83	4950328	2x4070000	-	-	-	5910077	5940107	-	5930031
				4950059	2x4070000	-	-	-	5910077	5940112	-	5930031

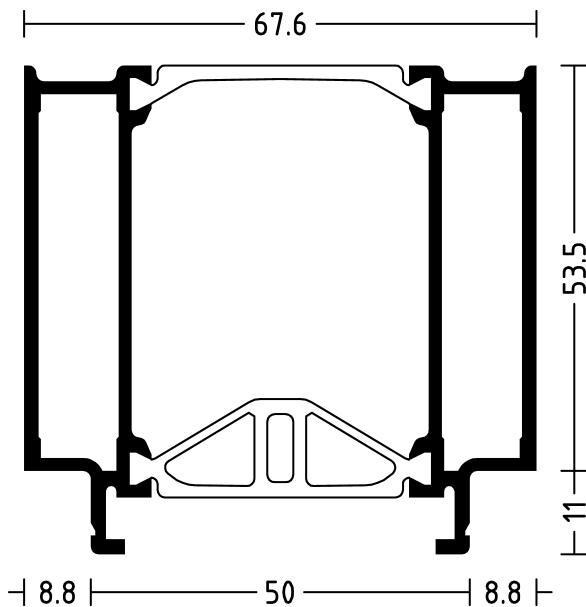

1920513

Für beidseitig fÜgelüberdeckende FÜllung.
For both-sided leaf overlapping infill.

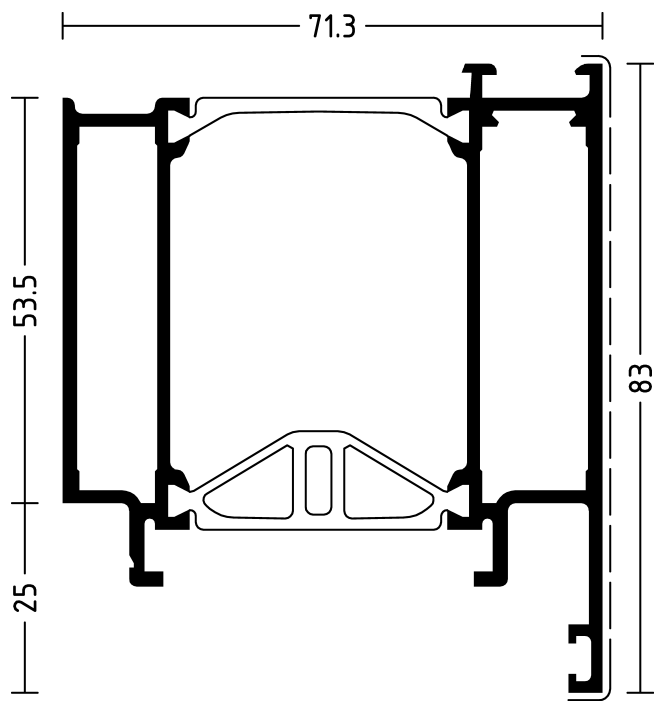















1920517

Für einseitig fÜgelüberdeckende FÜllung.
For single-sided leaf overlapping infill.







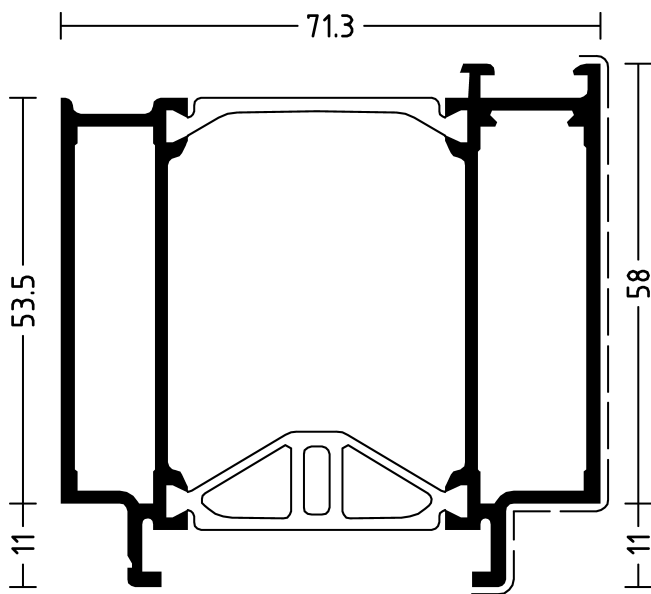







WICSTYLE 75 evo

Flügelprofile Sash profiles

												
	m	mm	mm									
 1320033	6,5	270	81	4950328	2x4070000	-	-	-	5910077	5940107	-	5930031
				4950059	2x4070000	-	-	-	5910077	5940112	-	5930031



1320033

												
	m	mm	mm									
 1917201	6,5	345	96	4950006	2x4070000	1x4960002	1x4070000	-	5910006	5940101	5940001	5930003
				4950006	2x4070000	1x4960002	1x4070000	-	5910006	5940101	5940001	5930003
1917202	6,5	353	104	4950007	2x4070000	1x4960003	1x4070000	1x4070030	5910006	5940101	5940001	5930003
				4950007	2x4070000	1x4960003	1x4070000	1x4070030	5910006	5940101	5940001	5930003

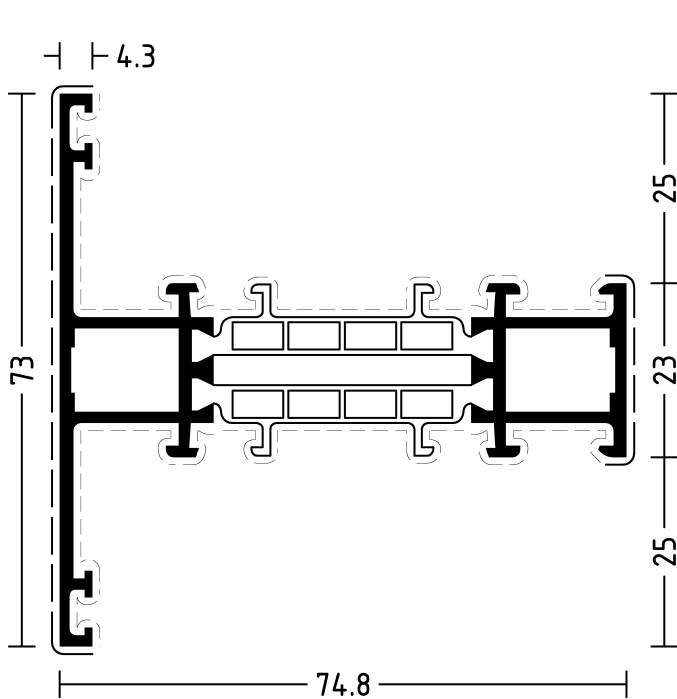

1917201

Gelenkeckwinkel und Gelenkverbinder siehe Zusatzartikel.
 Stoßverbindungen mit Tür-Flügelprofilen WICSTYLE 75 Verbinder 4960052 (außen).
 See additional articles for hinged corner angles and hinged connectors.
 Butt joint connections with WICSTYLE 75 door leaf profiles connector 4960052 (outwards).

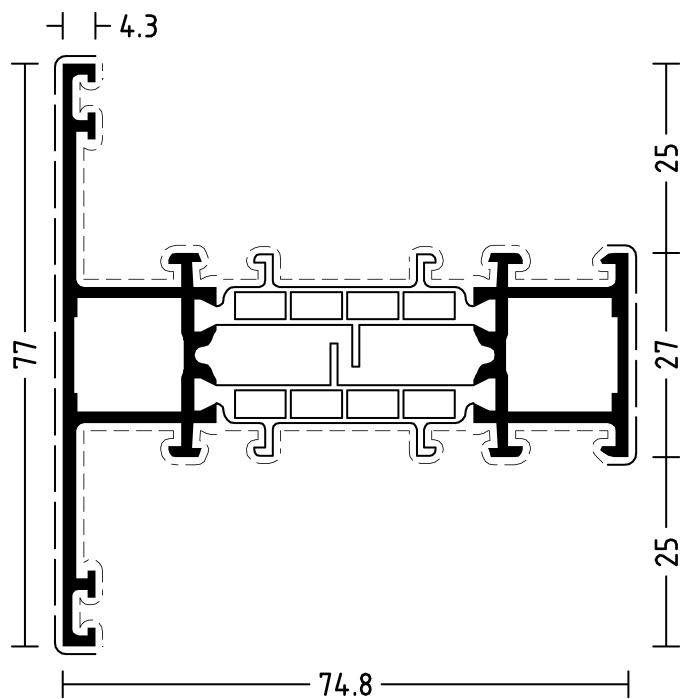















1917202

Gelenkeckwinkel und Gelenkverbinder siehe Zusatzartikel.
 Stoßverbindungen mit Tür-Flügelprofilen WICSTYLE 75 Verbinder 4960053 (außen).
 See additional articles for hinged corner angles and hinged connectors.
 Butt joint connections with WICSTYLE 75 door leaf profiles connector 4960053 (outwards).

WICSTYLE 75 evo

Kämpfer, Sprossenprofile
Transom, glazing bar profiles

	 m	 mm	 mm									
 1917203	6,5	359	110	4950008	2x4070000	1x4960004	1x4070000	1x4070030	5910006	5940101	5940001	5930003
				4950008	2x4070000	1x4960004	1x4070000	1x4070030	5910006	5940101	5940001	5930003
1917204	6,5	379	130	4950009	2x4070000	1x4960005	1x4070000	1x4070030	5910006	5940101	5940001	5930003
				4950009	2x4070000	1x4960005	1x4070000	1x4070030	5910006	5940101	5940001	5930003

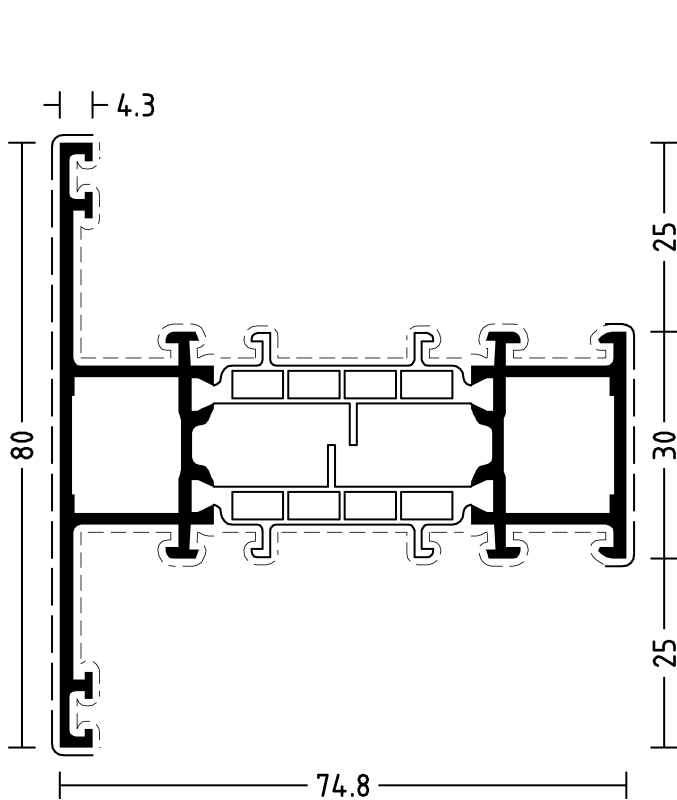





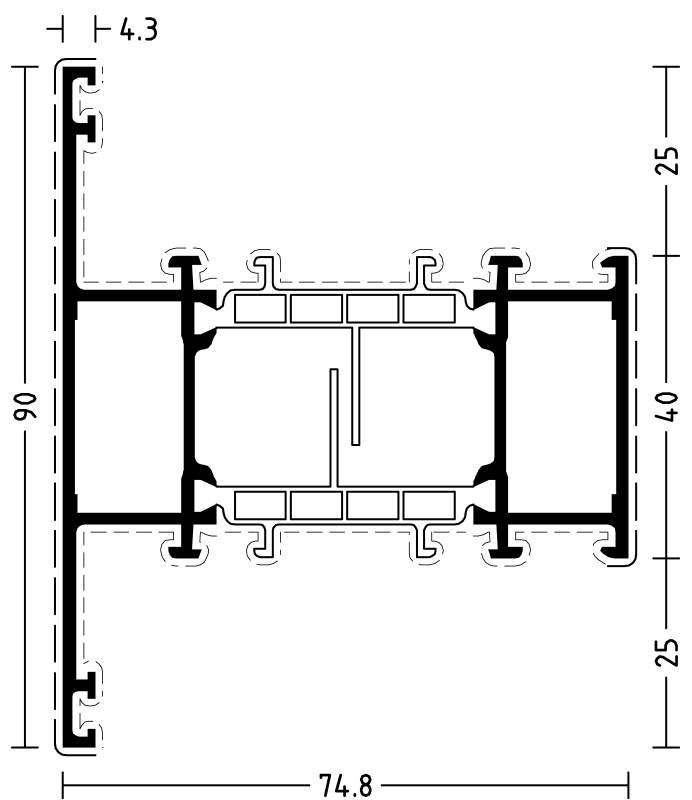







1917203

Gelenckwinkel und Gelenkverbinder siehe Zusatzartikel.
Stoßverbindungen mit Tür-Flügelprofilen WICSTYLE 75 Verbinder 4960054 (außen).
See additional articles for hinged corner angles and hinged connectors.
Butt joint connections with WICSTYLE 75 door leaf profiles connector 4960054 (outwards).



1917204

Gelenckwinkel und Gelenkverbinder siehe Zusatzartikel.
Stoßverbindungen mit Tür-Flügelprofilen WICSTYLE 75 Verbinder 4960055 (außen).
See additional articles for hinged corner angles and hinged connectors.
Butt joint connections with WICSTYLE 75 door leaf profiles connector 4960055 (outwards).

	m	mm	mm									
 1917205	6,5	399	150	4950010	2x4070000	1x4960006	1x4070000	1x4070030	5910006	5940101	5940001	5930003
 1917206	6,5	419	170	4950010	2x4070000	1x4960006	1x4070000	1x4070030	5910006	5940101	5940001	5930003
 1917205				4950011	2x4070000	1x4960007	2x4070000	2x4070030	5910006	5940101	5940001	5930003
 1917206				4950011	2x4070000	1x4960007	2x4070000	2x4070030	5910006	5940101	5940001	5930003

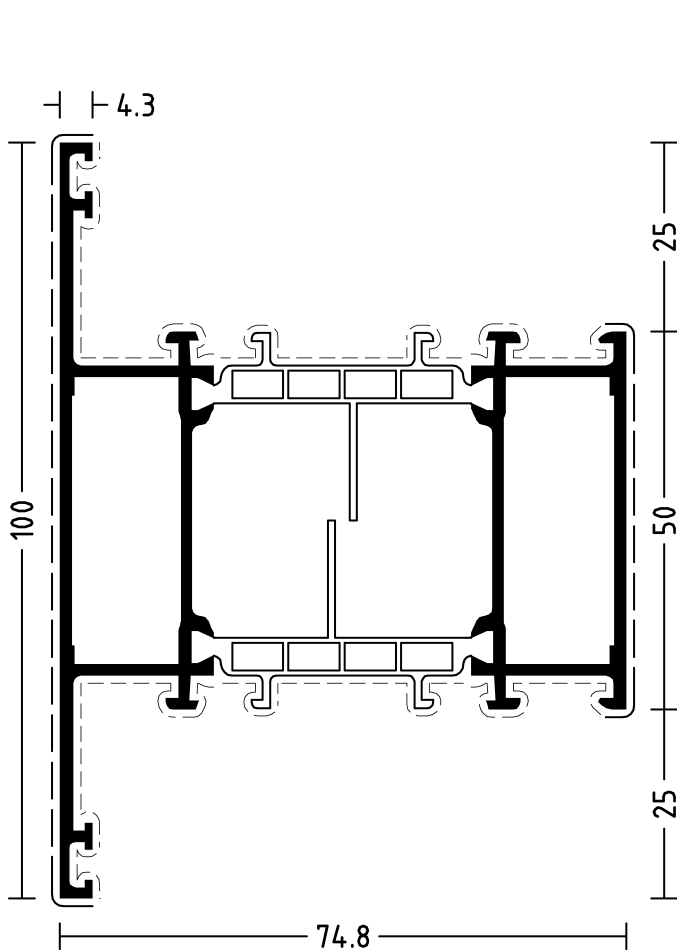

1917205

Stoßverbindungen mit Tür-Flügelprofilen WICSTYLE 75 Verbinder 4960056 (außen).
Butt joint connections with WICSTYLE 75 door leaf profiles connector 4960056 (outwards).

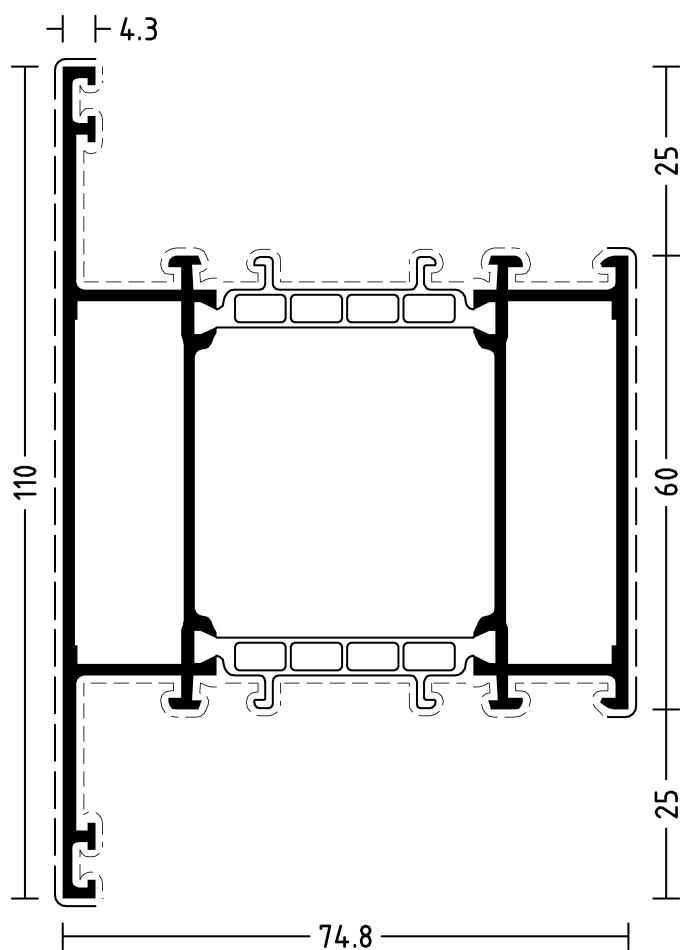















1917206

Stoßverbindungen mit Tür-Flügelprofilen WICSTYLE 75 Verbinder 4960057 (außen).
Butt joint connections with WICSTYLE 75 door leaf profiles connector 4960057 (outwards).

WICSTYLE 75 evo

Kämpfer, Sprossenprofile
Transom, glazing bar profiles

												
	m	mm	mm									
 1917207	6,5	439	190	-	-	1x4960008	2x4070000	2x4070030	5910006	5940101	5940001	5930003
				-	-	1x4960008	2x4070000	2x4070030	5910006	5940101	5940001	5930003
1917209	6,5	479	230	-	-	1x4960010	2x4070000	2x4070030	5910006	5940101	5940001	-
				-	-	1x4960010	2x4070000	2x4070030	5910006	5940101	5940001	-

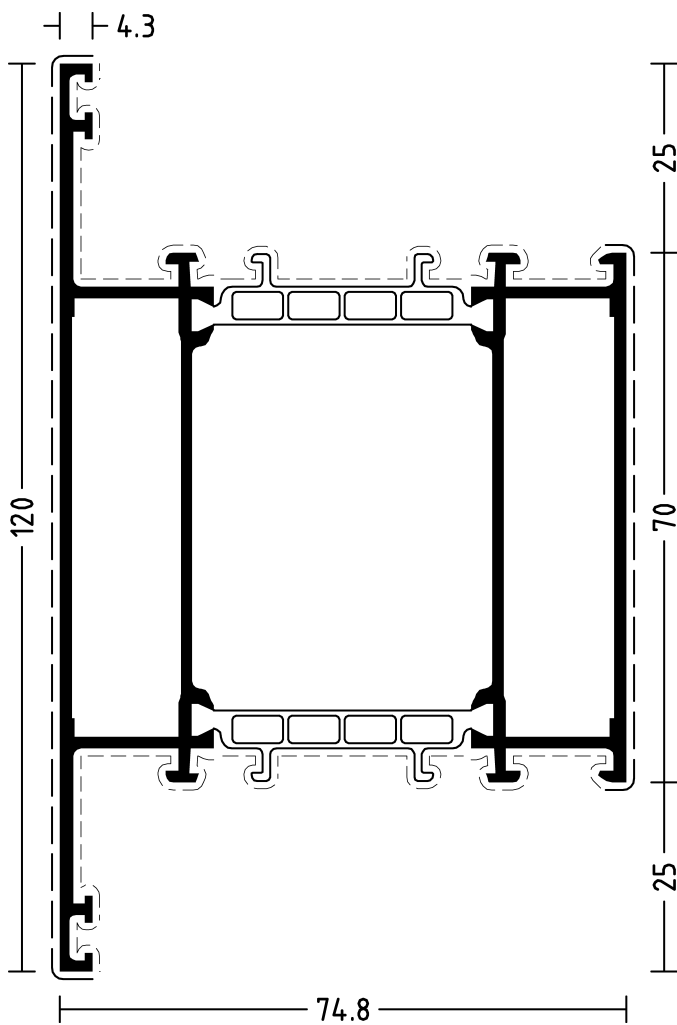

1917207

Eckverbindung außen/innen:
Zuschnitt aus 3900040 oder 3900053 (13.20) + 2x 4070000
Stoßverbindungen mit Tür-Flügelprofilen WICSTYLE 75 Verbinder 4960058 (außen).
Corner connection outside/inside:
Cutting with 3900040 or 3900053 (13.20) + 2x 4070000
Butt joint connections with WICSTYLE 75 door leaf profiles connector 4960058 (outside).

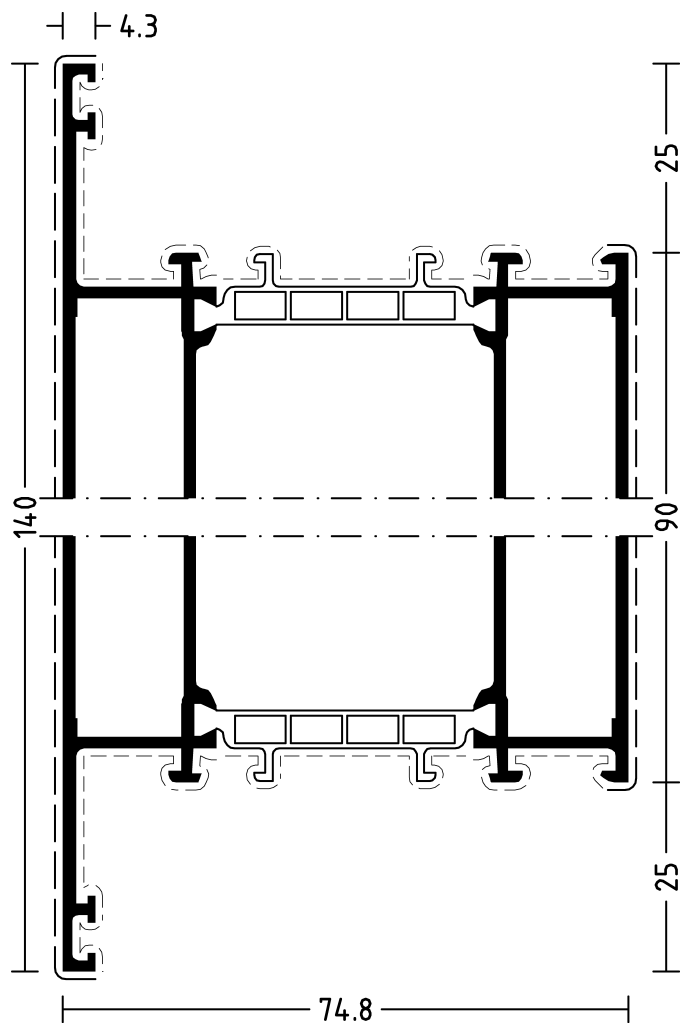















1917209

Stoßverbindungen mit Tür-Flügelprofilen WICSTYLE 75 Verbinder 4960060 (außen).
Butt joint connections with WICSTYLE 75 door leaf profiles connector 4960060 (outwards).

WICSTYLE 75 evo

Kämpfer, Sprossenprofile
Transom, glazing bar profiles

												
	m	mm	mm									
 1917211	6,5	519	270	-	-	1x4960012	2x4070000	2x4070030	5910006	5940101	5940001	-
				-	-	1x4960012	2x4070000	2x4070030	5910006	5940101	5940001	-
1917213	6,5	559	310	-	-	2x4960008	2x4070000	2x4070030	5910006	5940101	5940001	-
				-	-	2x4960004	2x4070000	2x4070030	5910006	5940101	5940001	-

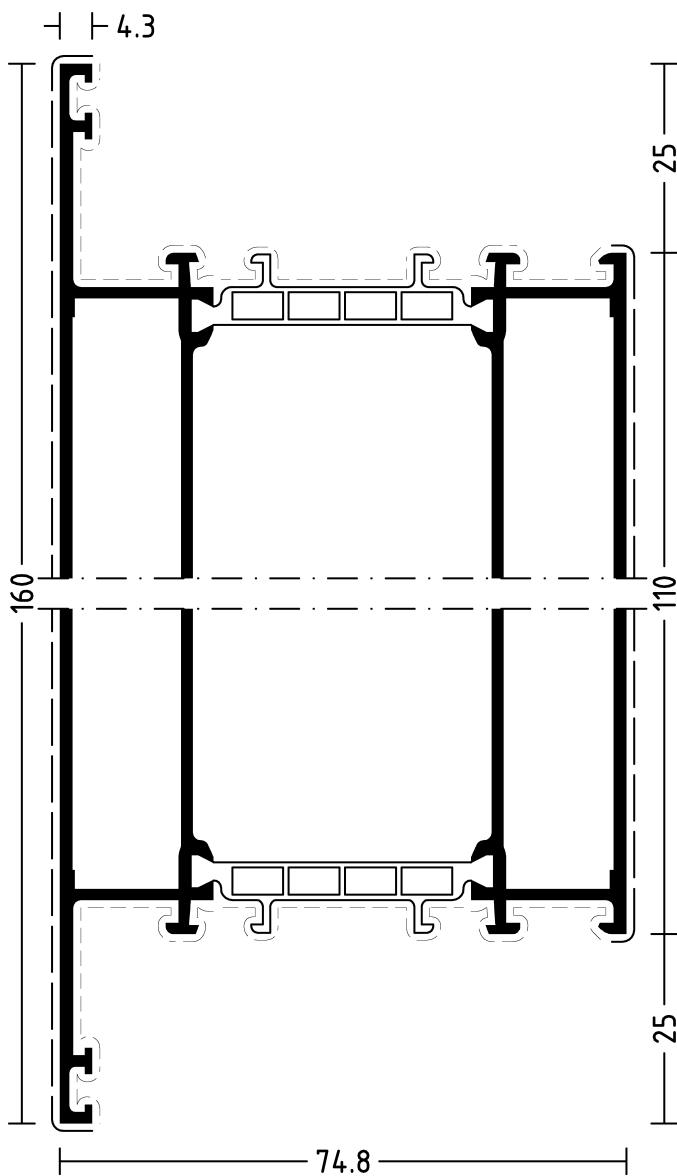

1917211

Stoßverbindungen mit Tür-Flügelprofilen WICSTYLE 75 Verbinder 4960062 (außen).
Butt joint connections with WICSTYLE 75 door leaf profiles connector 4960062 (outwards).

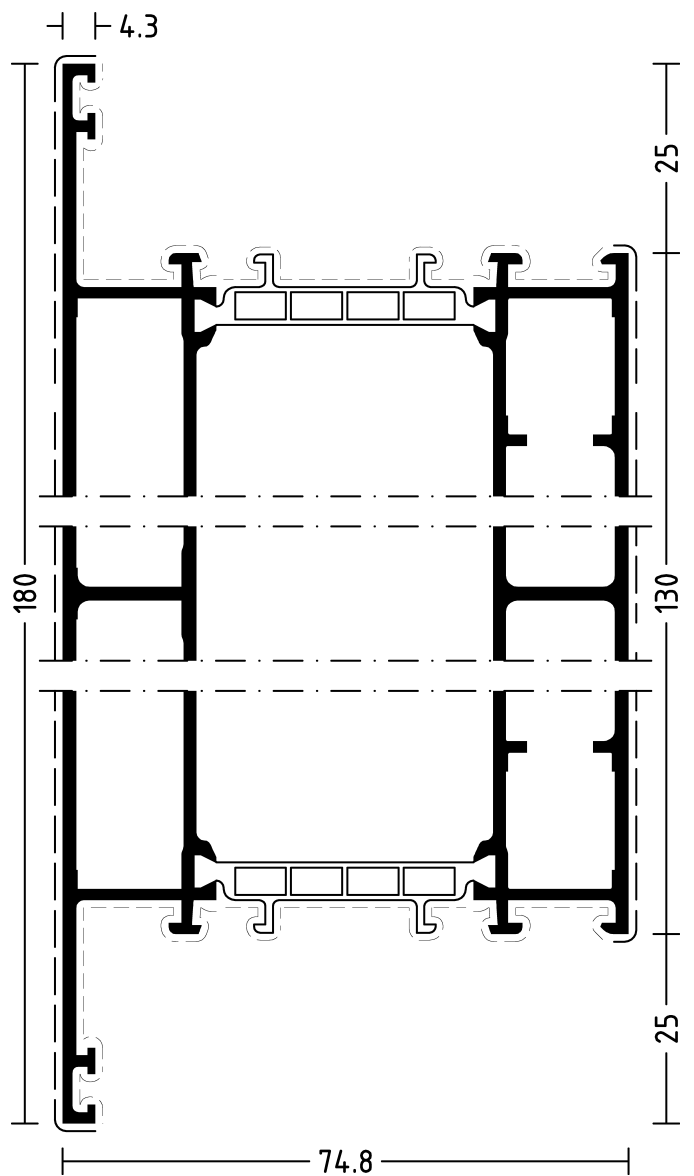















1917213

Stoßverbindungen mit Tür-Flügelprofilen WICSTYLE 75 Verbinder 4960058 (außen).
Butt joint connections with WICSTYLE 75 door leaf profiles connector 4960058 (outwards).

WICSTYLE 75 evo

Kämpfer, Sprossenprofile
Transom, glazing bar profiles

													
	m	mm	mm										
	1917215	6,5	599	350	-	-	2x4960009	2x4070000	2x4070030	5910006	5940101	5940001	-
					-	-	2x4960004	2x4070000	2x4070030	5910006	5940101	5940001	-

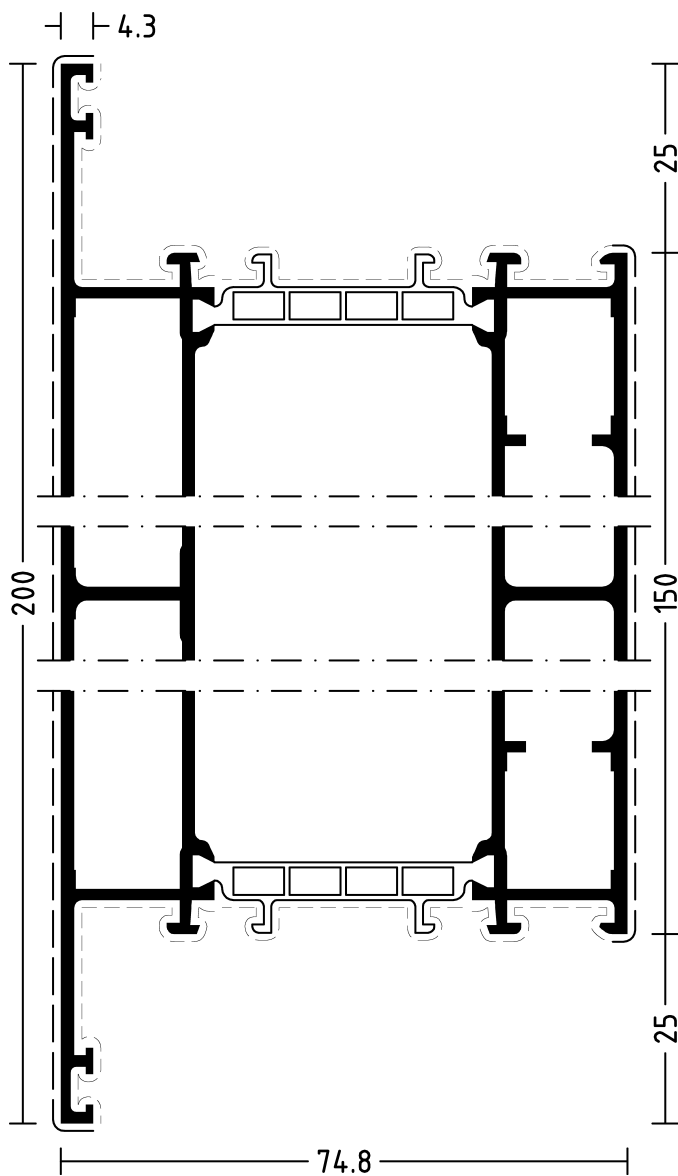















1917215

Stoßverbindungen mit Tür-Flügelprofilen WICSTYLE 75 Verbinder
4960059 (außen).
Butt joint connections with WICSTYLE 75 door leaf profiles connector
4960059 (outwards).

WICSTYLE 75 evo





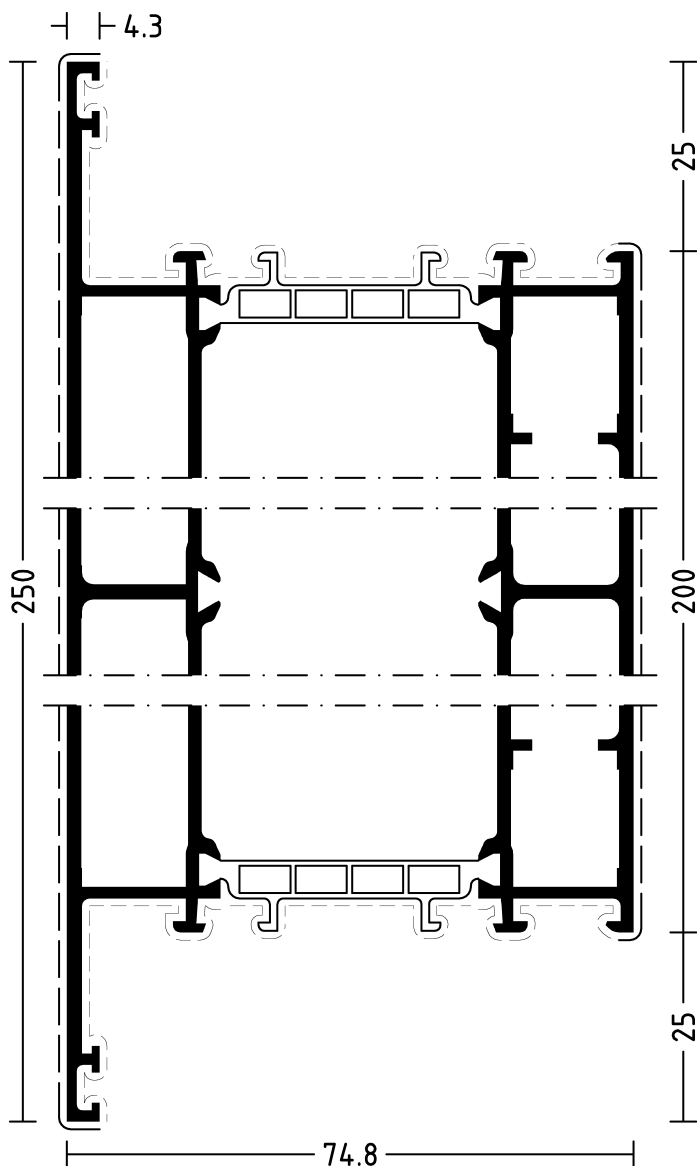









Kämpfer, Sprossenprofile
Transom, glazing bar profiles

												
	m	mm	mm									
 1917220	6,5	699	450	-	-	2x4960011	2x4070000	2x4070030	5910006	5940101	5940001	-
				-	-	2x4960004	2x4070000	2x4070030	5910006	5940101	5940001	-



1917220

Stoßverbindungen mit Tür-Flügelprofilen WICSTYLE 75 Verbinder
4960061 (außen).
Butt joint connections with WICSTYLE 75 door leaf profiles connector
4960061 (outwards).

												
	m	mm	mm									
 1917224	6,5	779	530	-	-	2x4960013	2x4070000	2x4070030	5910006	5940101	5940001	-
				-	-	2x4960004	2x4070000	2x4070030	5910006	5940101	5940001	-
1917336	6,5	253	64	-	-	-	-	-	-	-	-	-
				-	-	-	-	-	-	-	-	-

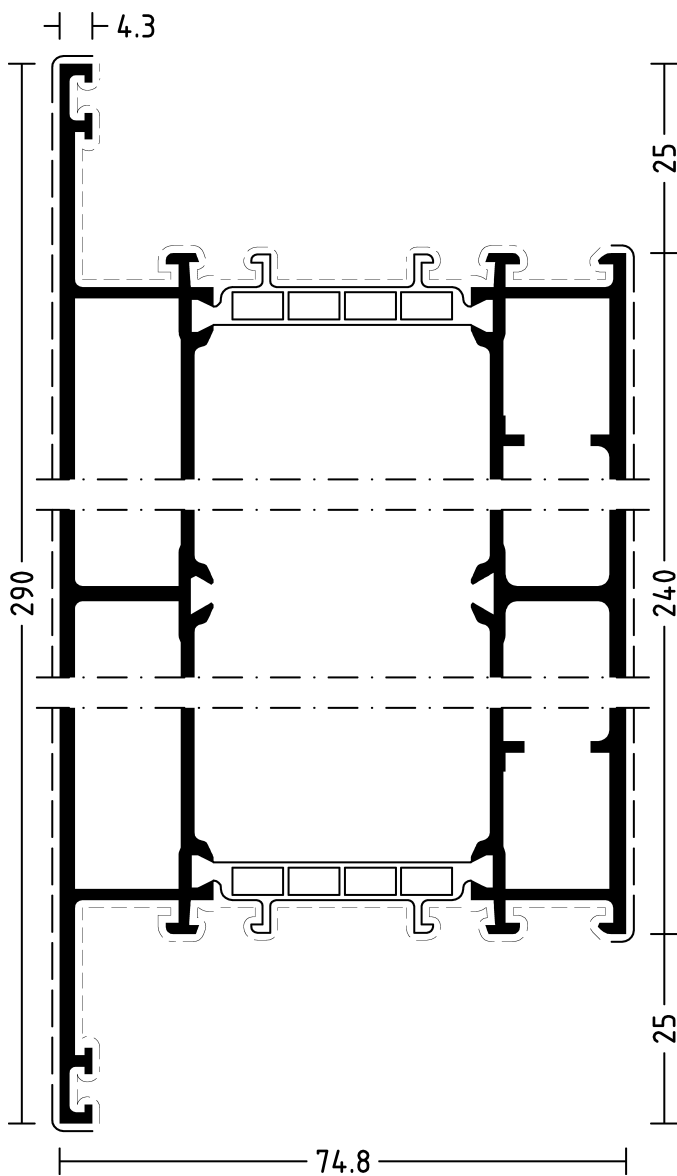

1917224

Stoßverbindungen mit Tür-Flügelprofilen WICSTYLE 75 Verbinder 4960063 (außen).
Butt joint connections with WICSTYLE 75 door leaf profiles connector 4960063 (outwards).

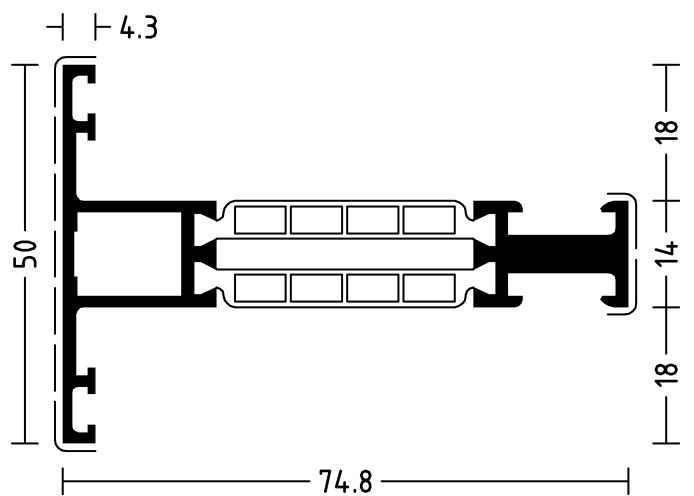















1917336

Stoßverbinder für alle Profilkombinationen siehe Seiten „Sprossenstoßverbindung“
See pages „butt joint connection of glazing bars“ for butt joint connector of all profile combinations

WICSTYLE 75 evo





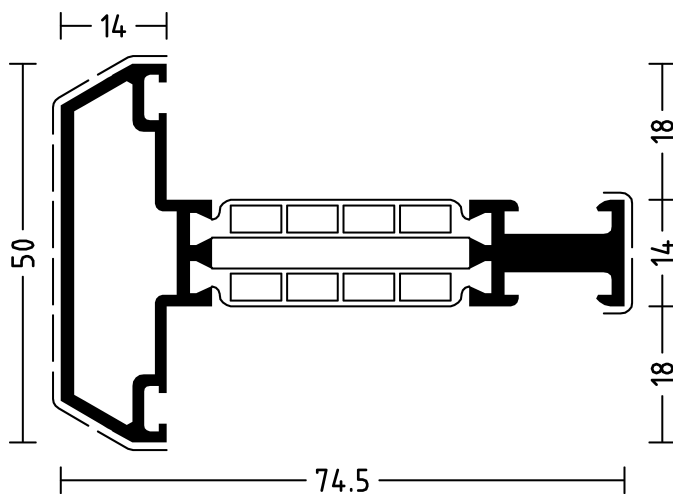









Kämpfer, Sprossenprofile
Transom, glazing bar profiles

												
 1917338	6,5	230	75	-	-	-	-	-	-	-	-	-
	-	-	-	-	-	-	-	-	-	-	-	-



1917338





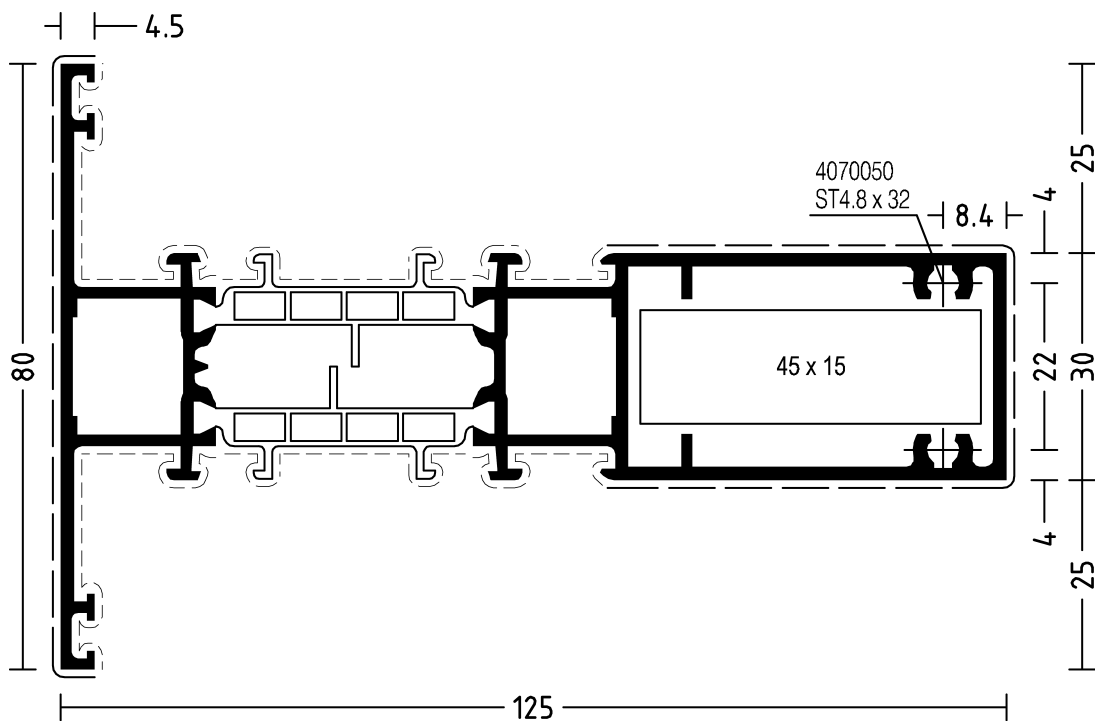









Stoßverbinder für alle Profilkombinationen
siehe Seiten „Sprossenstoßverbindung“
See pages „butt joint connection of glazing bars“ for butt joint connector of all profile combinations

												
	m	mm	mm									
 1917241	6,5	461	215	4950008	2x4070000	1x4960004	1x4070000	1x4070030	5910006	5940101	5940001	5930003
				4950008	2x4070000	1x4960004	1x4070000	1x4070030	5910006	5940101	5940001	5930003



1917241

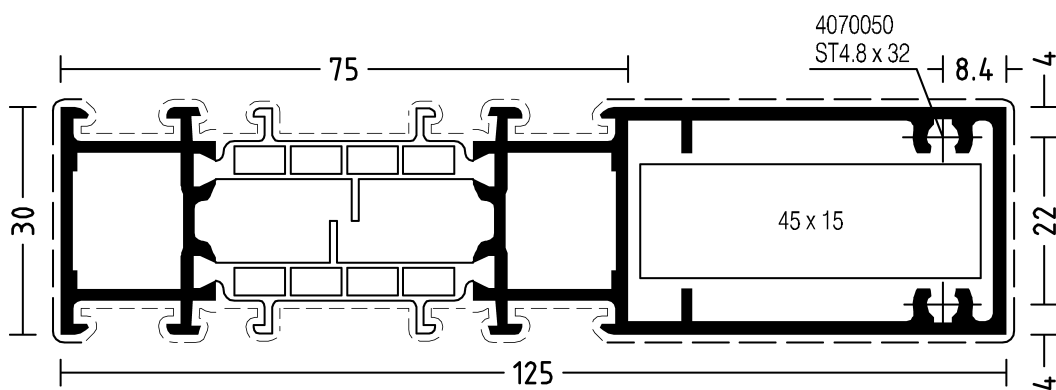

Gelenkeckwinkel und Gelenkverbinder siehe Zusatzartikel.
See additional articles for hinged corner angles and hinged connectors.

													
	m	mm	mm										
 1917244	6,5	336	165	4950008	2x4070000	1x4960004	1x4070000	1x4070030	5910006	5940101	5940001	5930003	
				4950008	2x4070000	1x4960004	1x4070000	1x4070030	5910006	5940101	5940001	5930003	



1917244





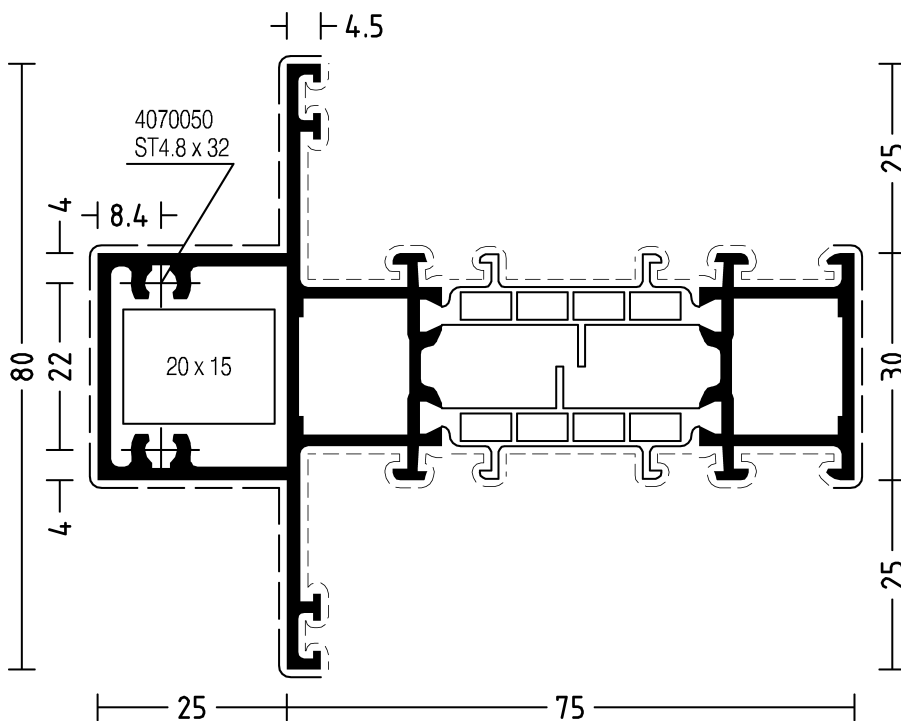









Gelenkeckwinkel und Gelenkverbinder siehe Zusatzartikel.
See additional articles for hinged corner angles and hinged connectors.

	m	mm	mm									
☒ 1917246	6,5	411	160	4950008	2x4070000	1x4960004	1x4070000	1x4070030	5910006	5940101	5940001	5930003
☒				4950008	2x4070000	1x4960004	1x4070000	1x4070030	5910006	5940101	5940001	5930003



1917246





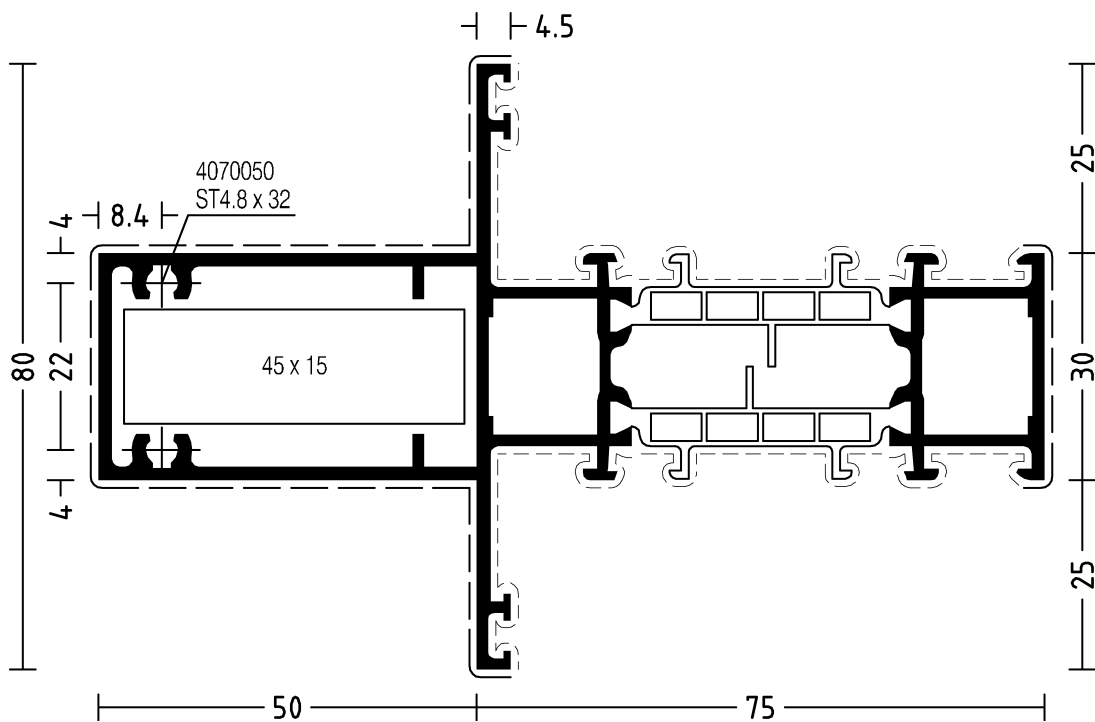









Gelenkeckwinkel und Gelenkverbinder siehe Zusatzartikel.
See additional articles for hinged corner angles and hinged connectors.

													
	m	mm	mm										
 1917247	6,5	461	210	4950008	2x4070000	1x4960004	1x4070000	1x4070030	5910006	5940101	5940001	5930003	
				4950008	2x4070000	1x4960004	1x4070000	1x4070030	5910006	5940101	5940001	5930003	



1917247





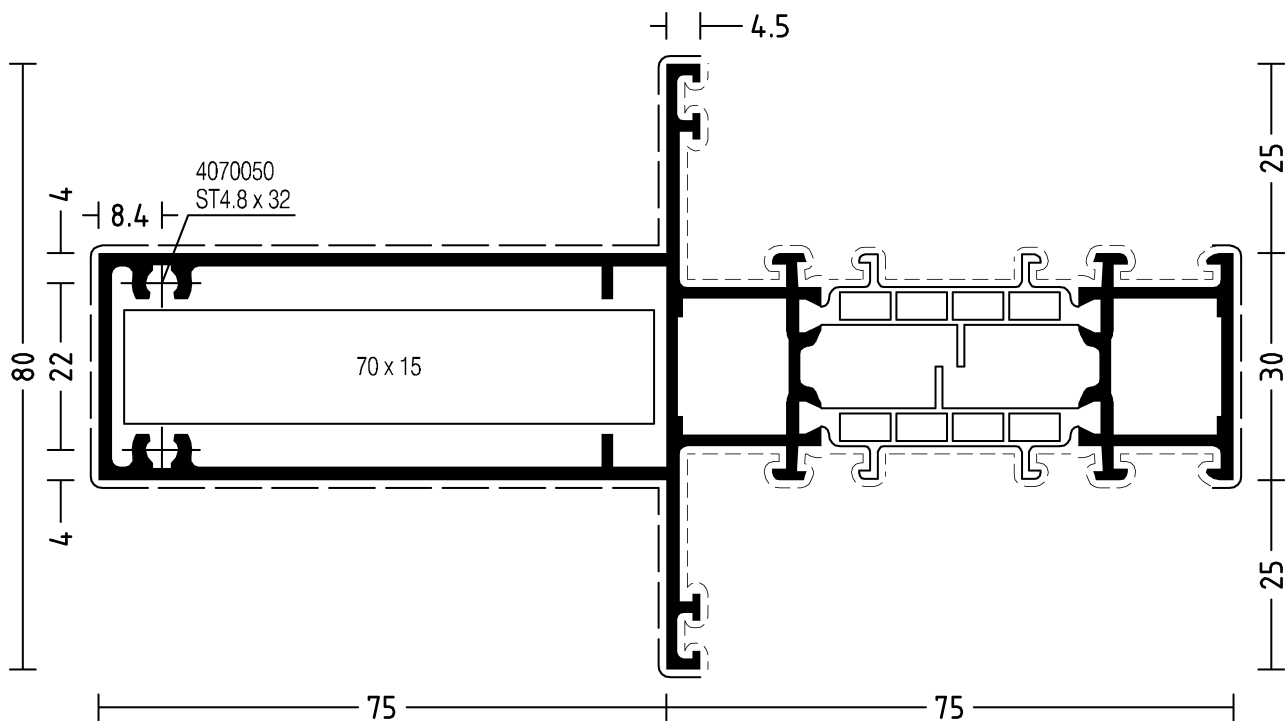









Gelenkeckwinkel und Gelenkverbinder siehe Zusatzartikel.
See additional articles for hinged corner angles and hinged connectors.

													
	m	mm	mm										
 1917248	6,5	511	260	4950008	2x4070000	1x4960004	1x4070000	1x4070030	5910006	5940101	5940001	5930003	
				4950008	2x4070000	1x4960004	1x4070000	1x4070030	5910006	5940101	5940001	5930003	









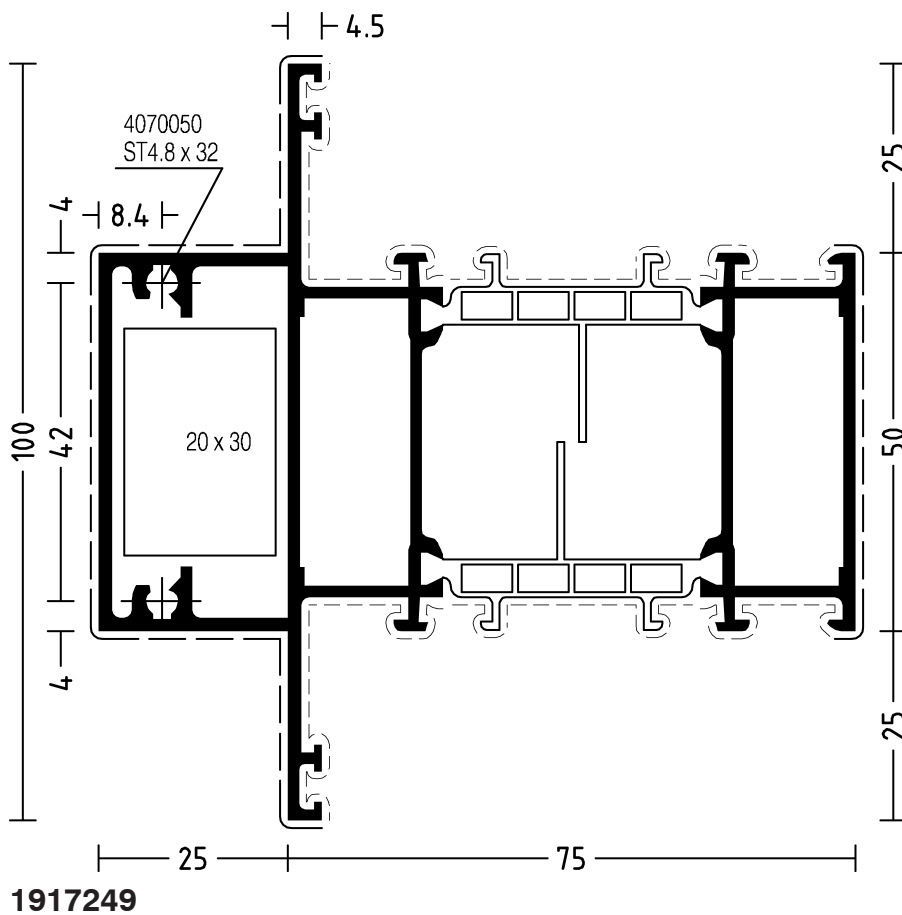







1917248









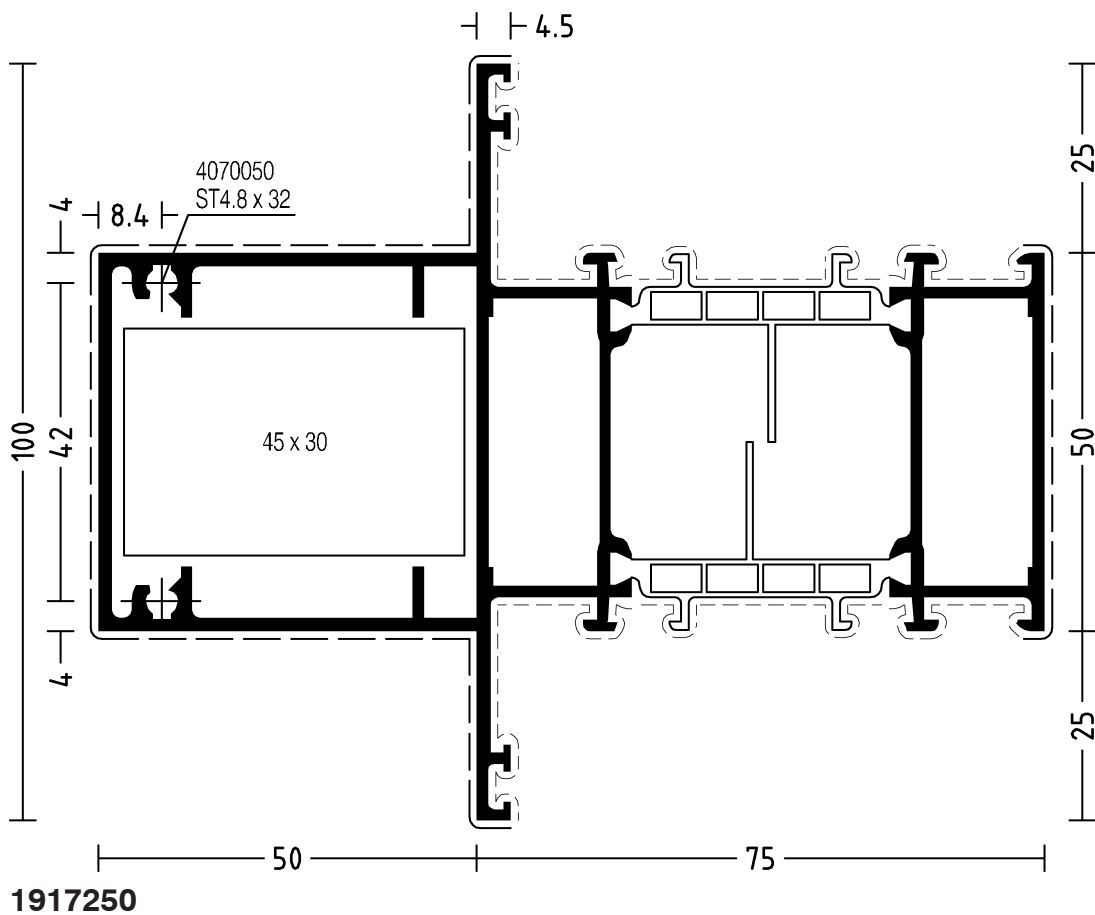





Gelenkeckwinkel und Gelenkverbinder siehe Zusatzartikel.
See additional articles for hinged corner angles and hinged connectors.

													
	m	mm	mm										
 1917249	6,5	451	200	4950010	2x4070000	1x4960006	1x4070000	1x4070030	5910006	5940101	5940001	5930003	
				4950010	2x4070000	1x4960006	1x4070000	1x4070030	5910006	5940101	5940001	5930003	









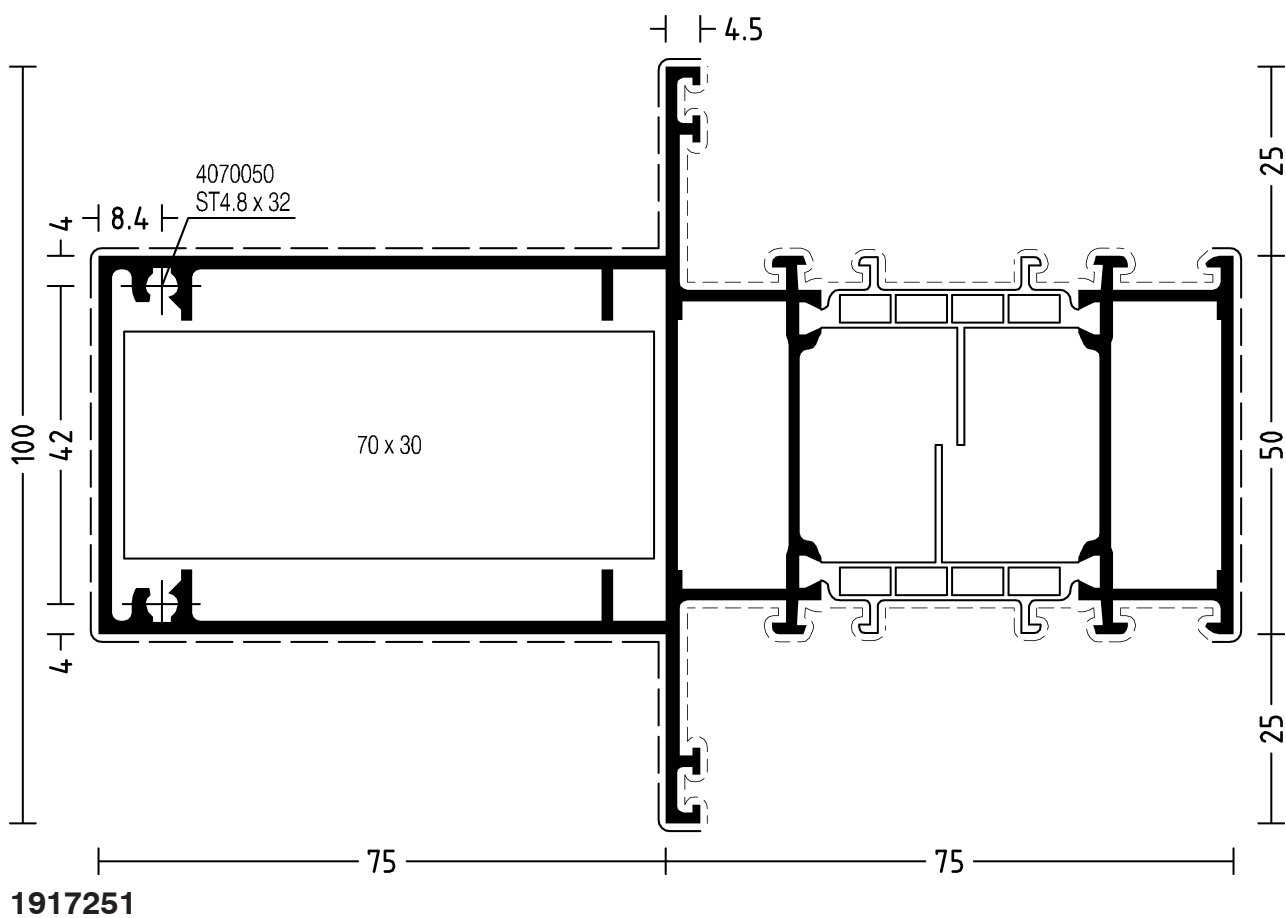







													
	m	mm	mm										
 1917250	6,5	501	250	4950010	2x4070000	1x4960006	1x4070000	1x4070030	5910006	5940101	5940001	5930003	
				4950010	2x4070000	1x4960006	1x4070000	1x4070030	5910006	5940101	5940001	5930003	



	 m	 mm	 mm									
 1917251	6,5	551	300	4950010	2x4070000	1x4960006	1x4070000	1x4070030	5910006	5940101	5940001	5930003
				4950010	2x4070000	1x4960006	1x4070000	1x4070030	5910006	5940101	5940001	5930003





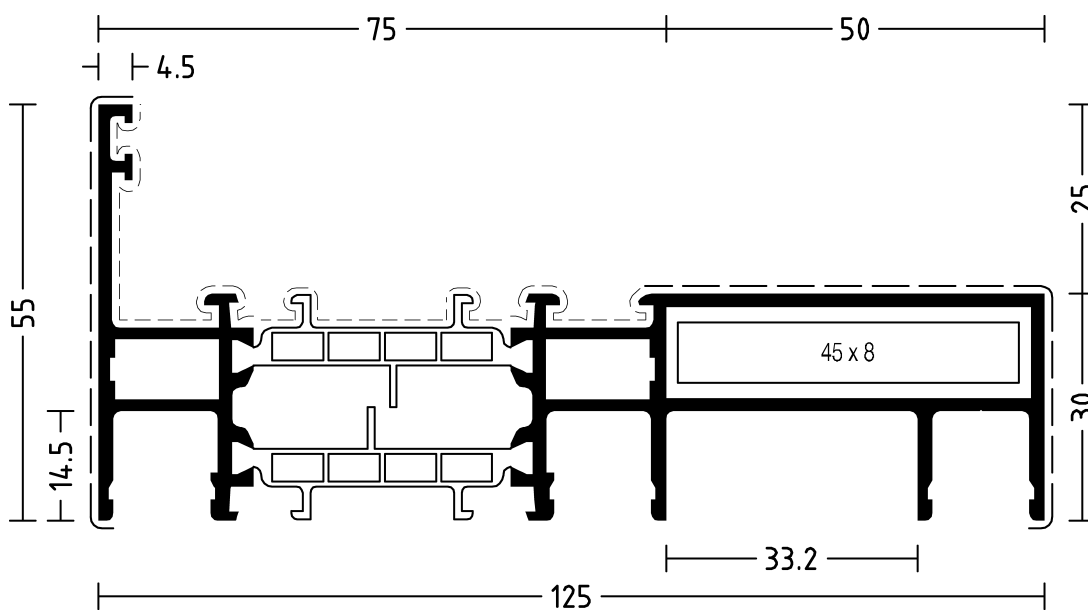











												
	m	mm	mm									
 1917256	6,5	486	138	4950005	2x4070009	-	-	-	5910006	-	-	5930003
				4950005	2x4070009	-	-	-	5910006	-	-	5930003



1917256





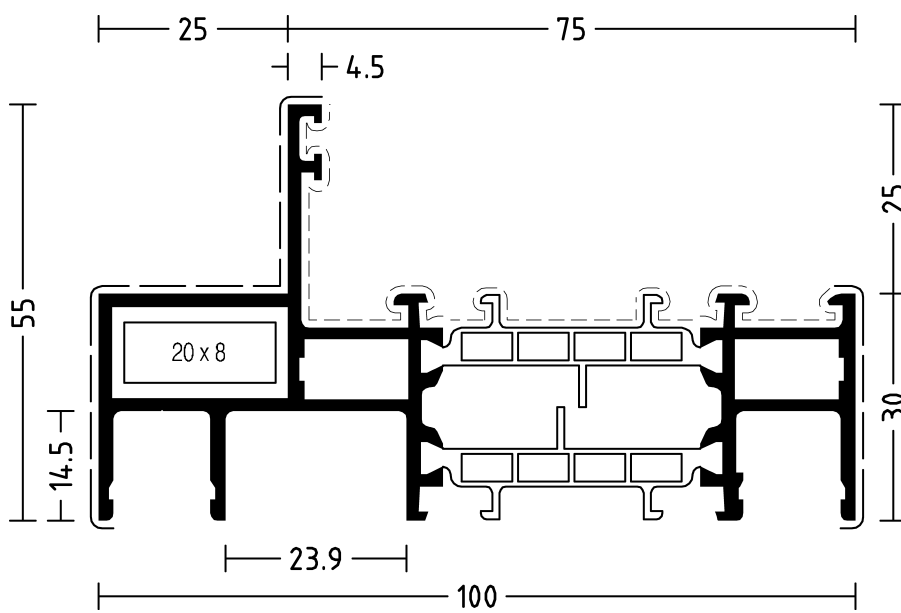









Gelenkeckwinkel und Gelenkverbinder siehe Zusatzartikel.
See additional articles for hinged corner angles and hinged connectors.

												
	m	mm	mm									
 1917258	6,5	405	110	4950005	2x4070009	-	-	-	5910006	-	-	5930003
				4950005	2x4070009	-	-	-	5910006	-	-	5930003



1917258





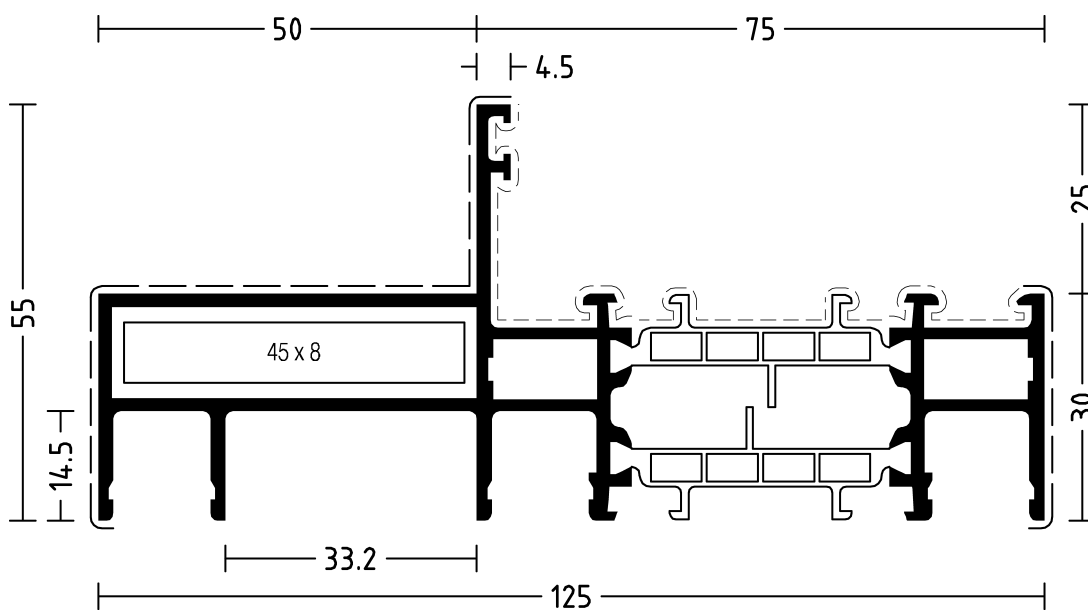









Gelenkeckwinkel und Gelenkverbinder siehe Zusatzartikel.
See additional articles for hinged corner angles and hinged connectors.

												
	m	mm	mm									
 1917259	6,5	486	135	4950005	2x4070009	-	-	-	5910006	-	-	5930003
				4950005	2x4070009	-	-	-	5910006	-	-	5930003



1917259

Gelenkeckwinkel und Gelenkverbinder siehe Zusatzartikel.
See additional articles for hinged corner angles and hinged connectors.

												
	m	mm	mm									
 1917260	6,5	536	160	4950005	2x4070009	-	-	-	5910006	-	-	5930003
				4950005	2x4070009	-	-	-	5910006	-	-	5930003

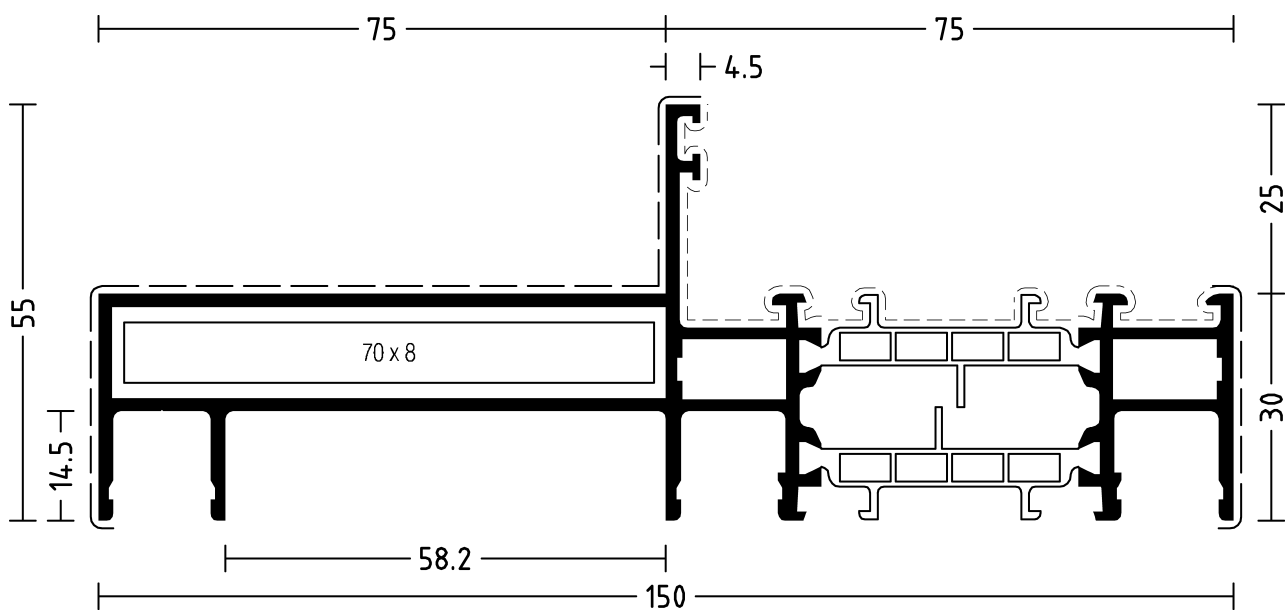

1917260

Gelenkeckwinkel und Gelenkverbinder siehe Zusatzartikel.
See additional articles for hinged corner angles and hinged connectors.

WICSTYLE 75 evo





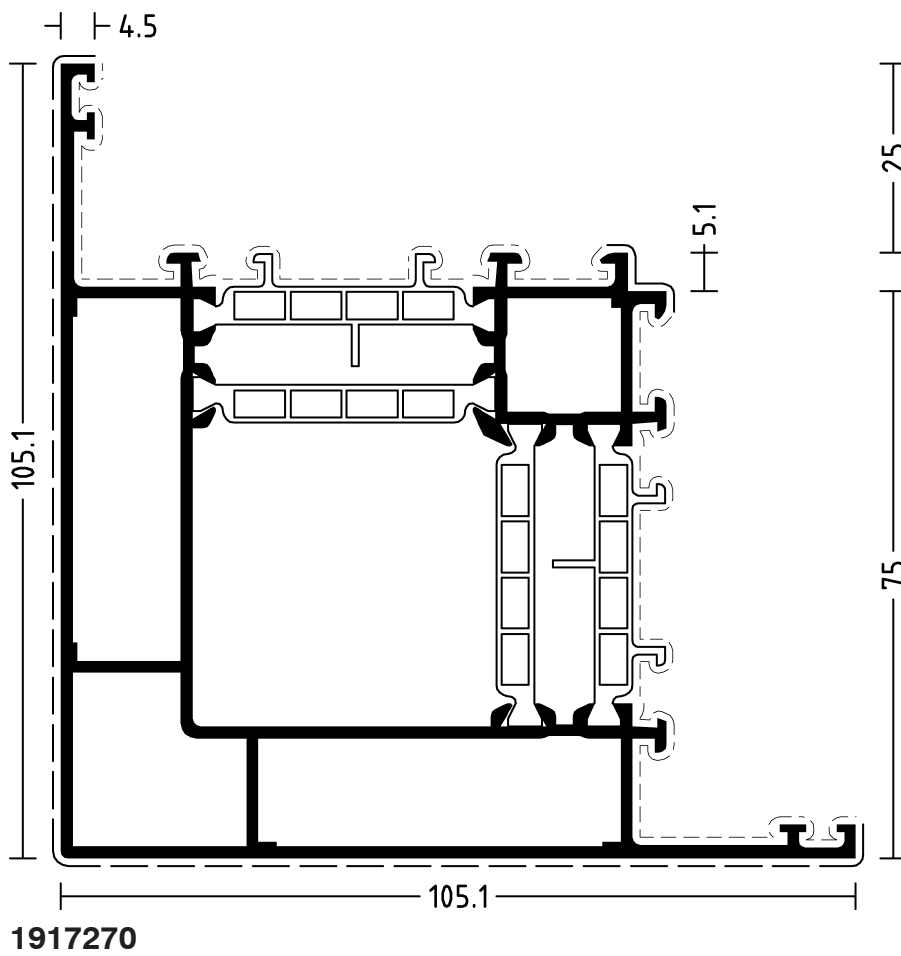





Stützenprofile
Mullion profiles

□ 1917270	 m mm mm			 - -		 2x4960007 2x4070000 2x4070030			 5910006 5940101 5940001 -			
	□	-	-	-	-	-	-	5910006	5940101	5940001	-	
□	-	-	-	-	-	-	-	5910006	5940101	5940001	-	



WICSTYLE 75 evo

Stützenprofile
Mullion profiles



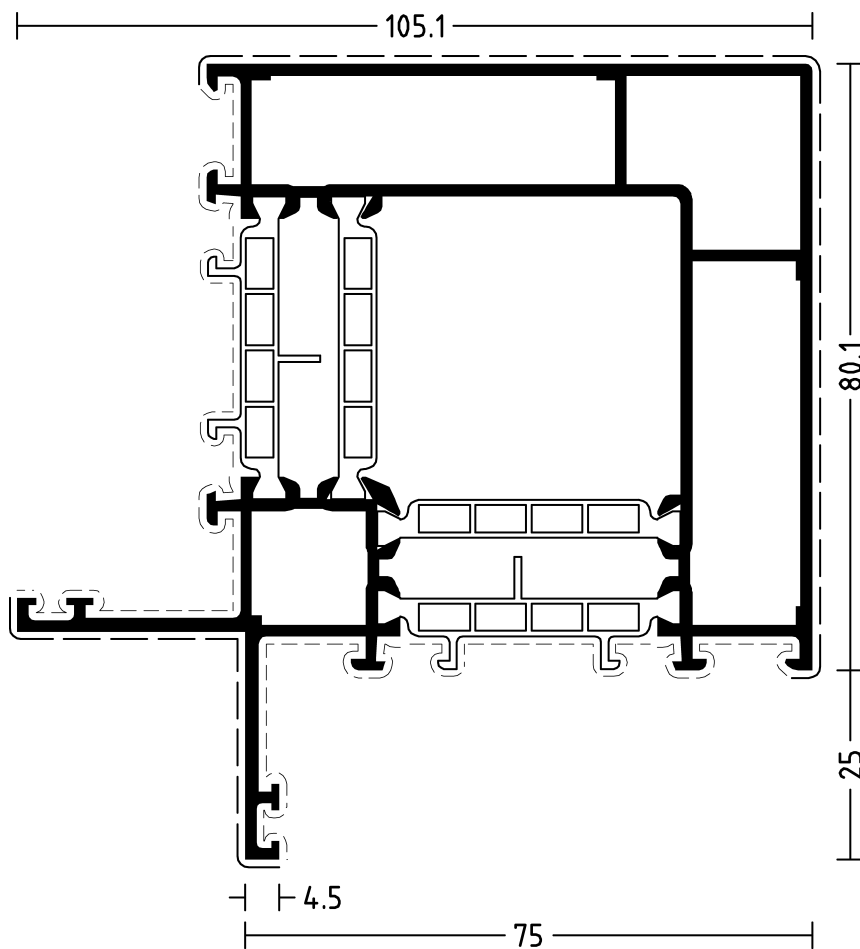











☒ 1917271	 m mm mm			 		  			   			
	☒	6,5	471	220	-	-	-	-	-	5910006	5940101	5940001
				-	-	2x4960007	2x4070000	2x4070030	5910006	5940101	5940001	-



1917271

WICSTYLE 75 evo

Stützenprofile Mullion profiles

	 m	 mm	 mm									
 1917272	6,5	346	170	-	-	2x4960007	2x4070000	2x4070030	5910006	5940101	5940001	-
				-	-	-	-	-	5910006	5940101	5940001	-
1917273	6,5	274	98	-	-	1x4960005	2x4070000	2x4070030	5910006	5940101	5940001	-
				-	-	1x4960050	2x4070009	-	5910006	5940101	5940001	-

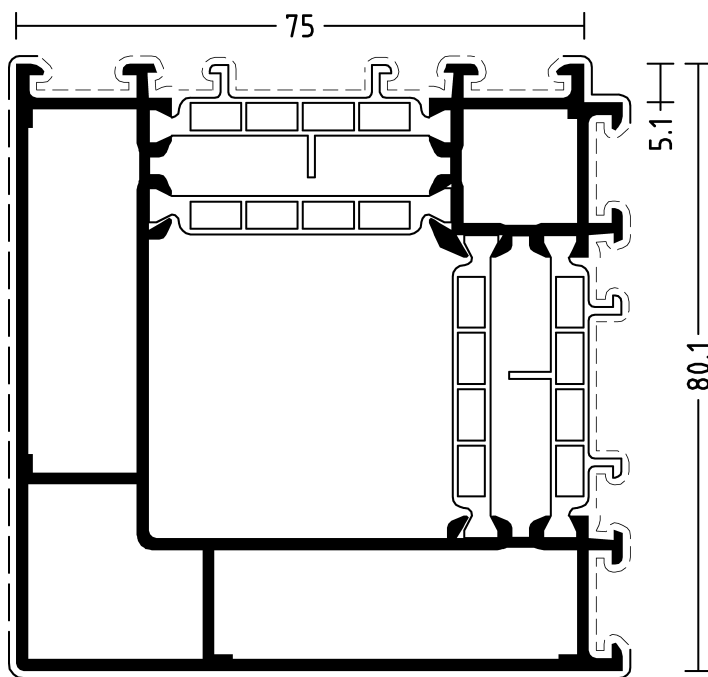

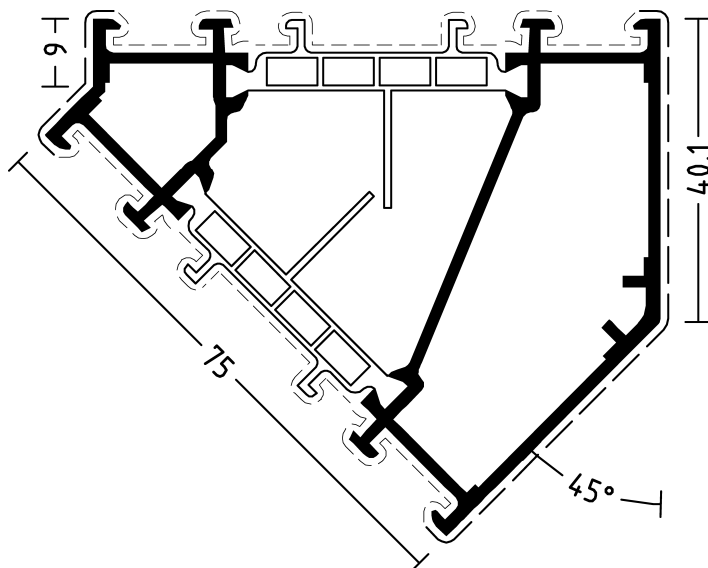

1917272



1917273



WICSTYLE 75 evo

Kupplungsprofile
Coupling profiles

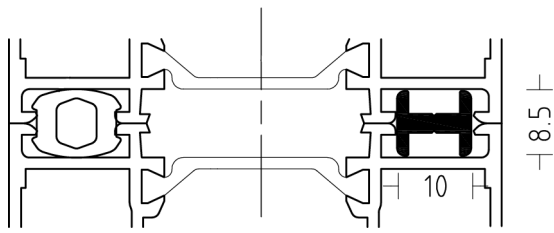
	 m	 mm	 mm
134026	6	47	0



134026

	 m	 mm	 mm
1020496	6,5	259	68
1927524	6,5	229	48
1927525	6,5	198	45
1927526	6,5	197	70
3021033	6	74	0
3927501	6,5	126	0

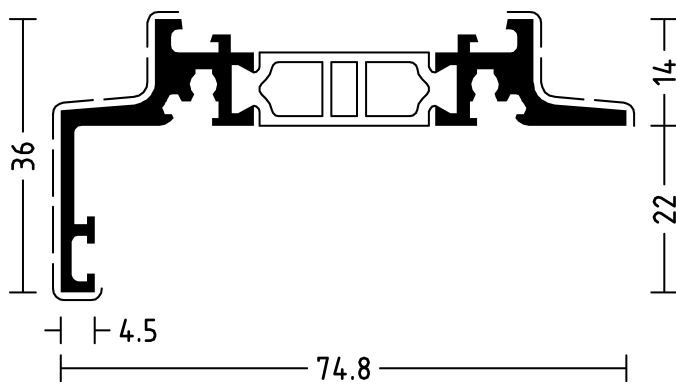

1020496

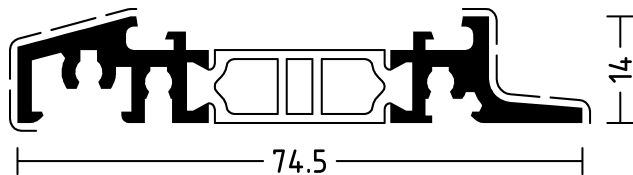

1927524

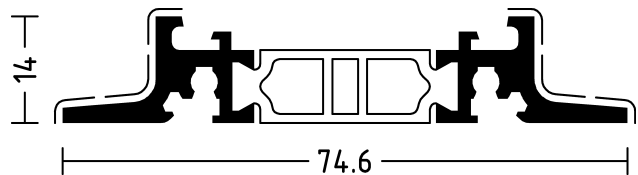

1927525

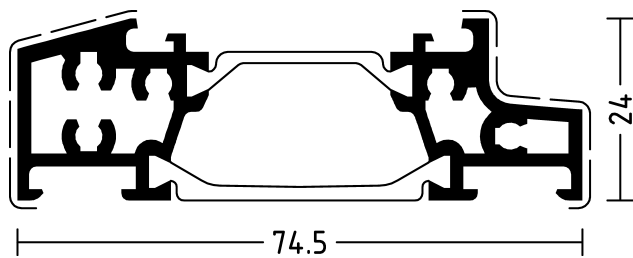

1927526

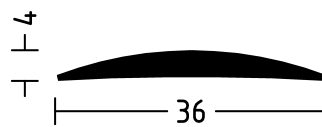

3021033



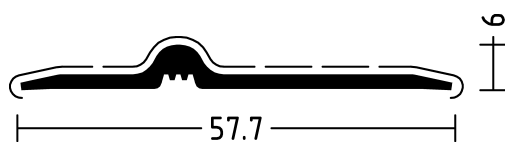











Schwellenprofil für Schleifdichtung
Threshold profile for sliding gasket











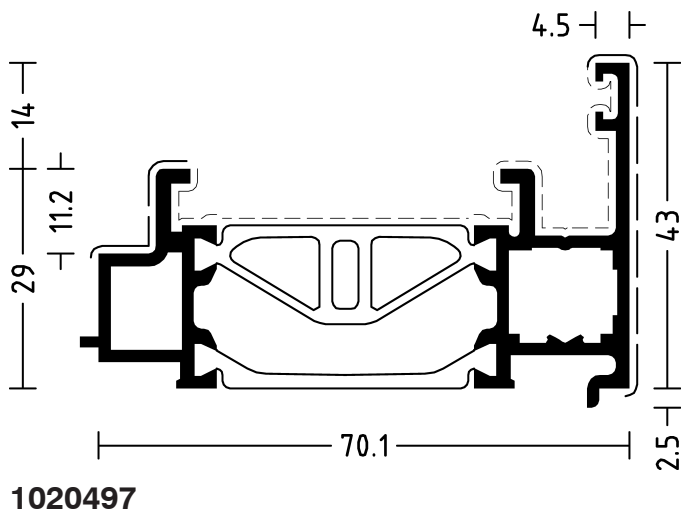
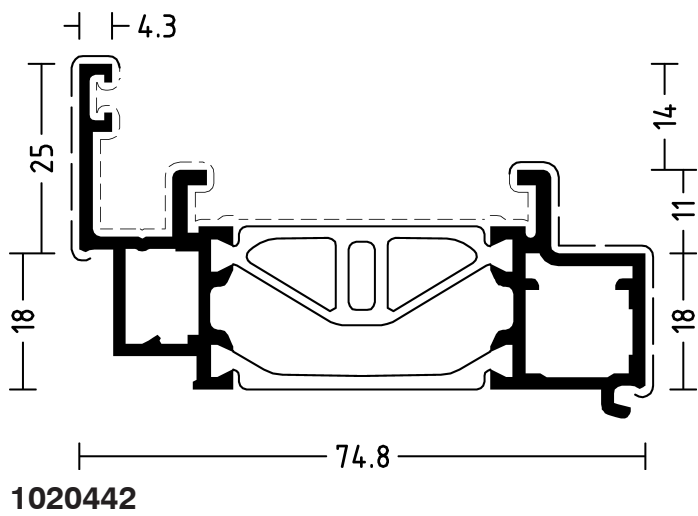



3927501

WICSTYLE 75 evo

Aufsatzprofile Supplementary profiles

	 m	 mm	 mm										
 1020442	6,5	247	67	-	-	-	-	-	-	-	-	-	-
 1020497	6,5	251	59	-	-	-	-	-	-	-	-	-	-



	m	mm	mm									
 1020498	6,5	247	48	-	-	-	-	-	-	-	-	-
 1917301	6,5	193	60	4950057	-	-	-	-	-	-	-	5930003
				4950008	2x4070000	-	-	-	-	5940101	-	5930003

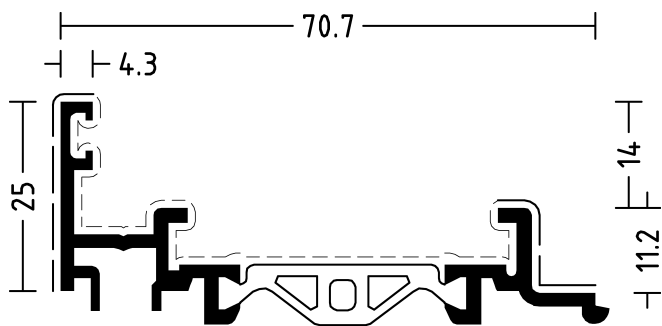



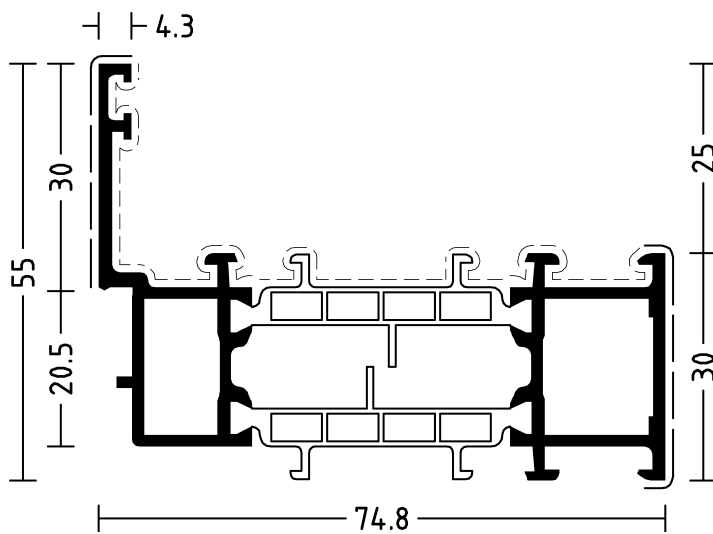





1020498



1917301

Falzverbreiterungsprofil
 Eckverbindung außen:
 Selbstzuschnitt oder Al-Eckwinkel konfektioniert 4950057.
Rebate widening profile
Corner connection outer shell:
Self-cut or prefabricated corner angle 4950057.

	 m	 mm	 mm								
 1917303	6,5	277	60	4950057	-	-	-	-	-	-	5930003
 1927520	6,5	168	39	4950008	2x4070000	-	-	-	5940101	-	5930003
				-	-	-	-	-	-	-	-
				-	-	-	-	-	-	-	-

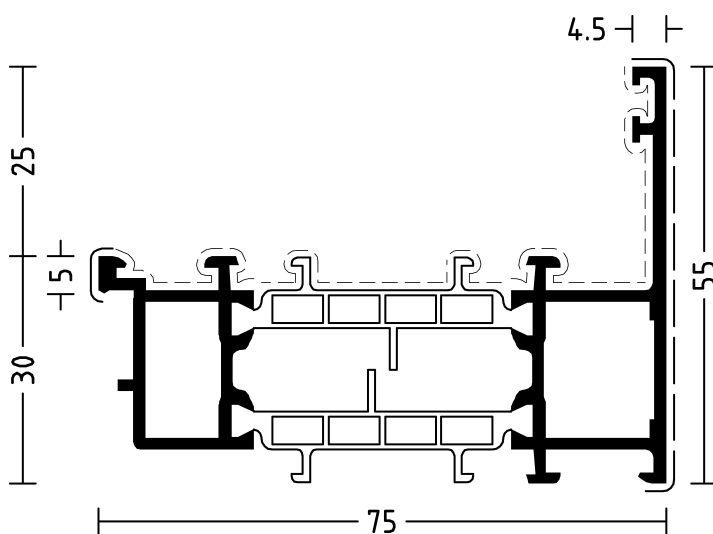

1917303

Wechselprofil von außen verglast!
 Eckverbindung außen:
 Selbstzuschneit oder Al-Eckwinkel konfektioniert 4950057.
 Stoßverbindung nicht möglich.
 Profil nicht für Beschlagseinbau geeignet!
Rebate reversion profile, glazing from outside!
Corner connection outer shell:
Self-cut or prefabricated corner angle 4950057.
Butt-joint connection not possible.
Profile not suitable for fitting installation!

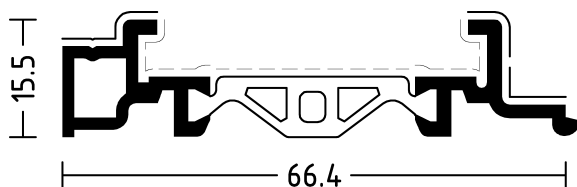









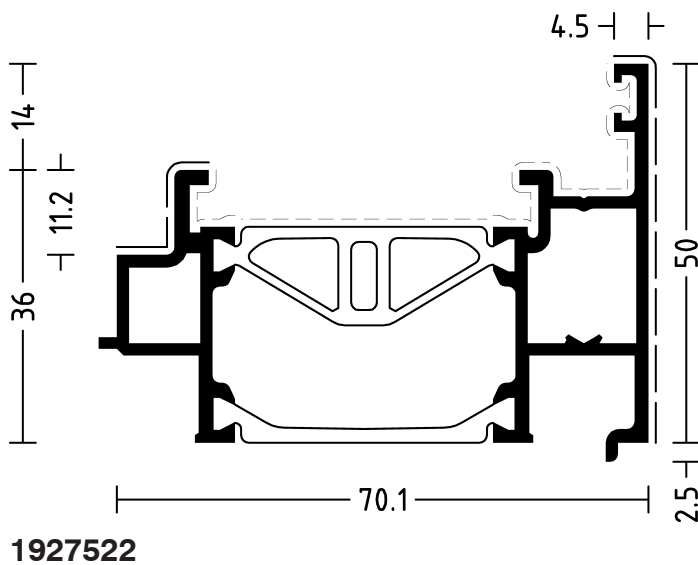
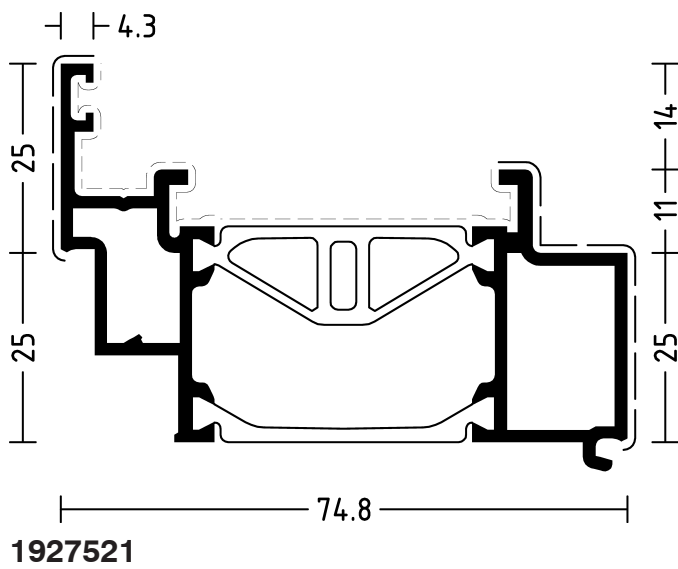





1927520

WICSTYLE 75 evo

Aufsatzprofile Supplementary profiles







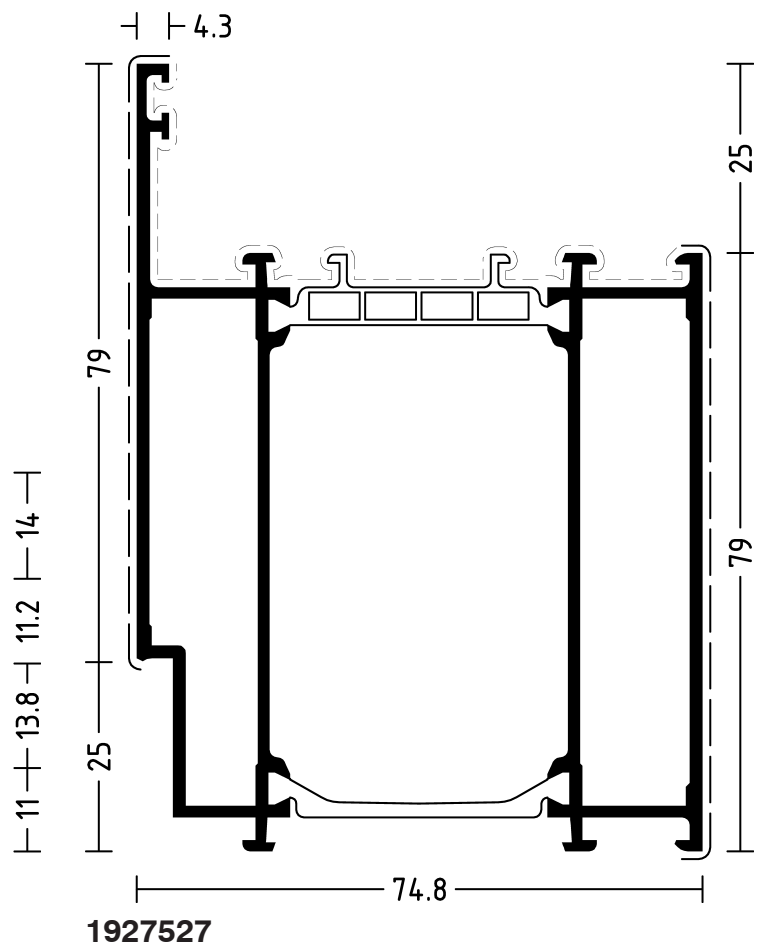
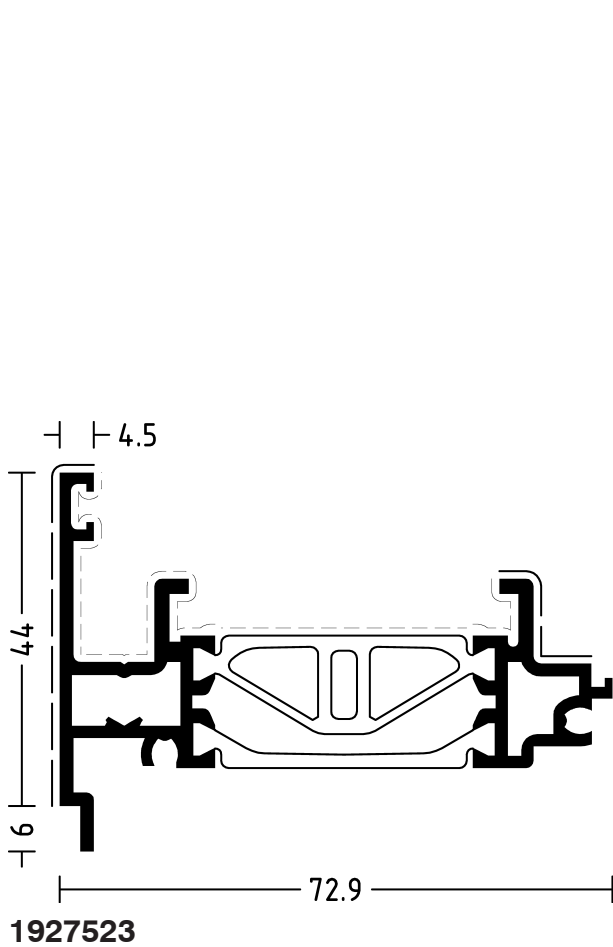







	m	mm	mm										
1927521	6,5	250	72	-	-	-	-	-	-	-	-	-	-
1927522	6,5	269	68	-	-	-	-	-	-	-	-	-	-



												
	m	mm	mm									
 1927523	6,5	275	62	-	-	-	-	-	-	-	-	-
	-	-	-	-	-	-	-	-	-	-	-	-
1927527	6,5	384	158	-	-	1x4960069	1x4070000	1x4070030	5910006	5940101	5940001	-
	-	-	-	-	-	1x4960071	2x4070000	2x4070030	5910006	5940101	5940001	-



Stoßverbindungen mit Tür-Flügelprofilen WICSTYLE 65 Verbinder 4960067 (außen).
Butt joint connections with WICSTYLE 65 door leaf profiles, connector 4960067 (outside).

	 m	 mm	 mm									
 1927528	6,5	404	178	-	-	1x4960070	1x4070000	1x4070030	5910006	5940101	5940001	-
 1927529	6,5	164	18	-	-	1x4960072	2x4070000	2x4070030	5910006	5940101	5940001	-
				-	-	-	-	-	-	-	-	-

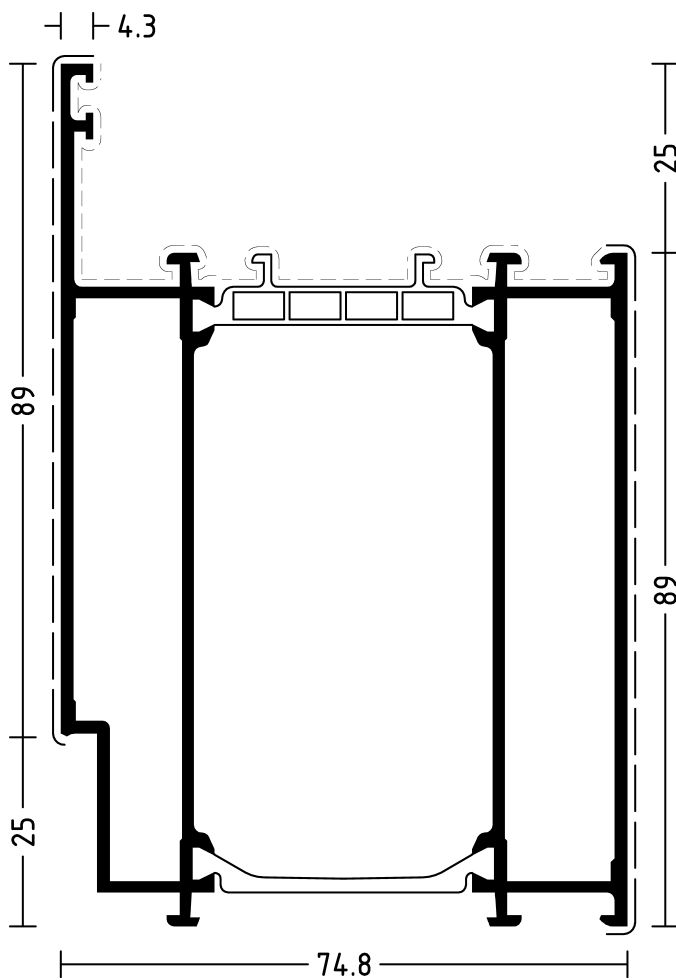

1927528



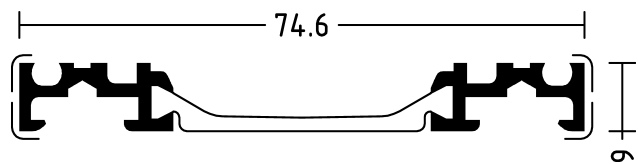











Stoßverbindungen mit Tür-Flügelprofilen WICSTYLE 65 Verbinder 4960068 (außen).
Butt joint connections with WICSTYLE 65 door leaf profiles, connector 4960068 (outside).



1927529

WICSTYLE 75 evo

Aufsatzprofile Supplementary profiles

												
	m	mm	mm									
 1927530	6,5	228	48	-	-	-	-	-	-	-	-	-
 1927531	6,5	178	25	-	-	-	-	-	-	-	-	-
1927532	6,5	232	43	-	-	-	-	-	-	-	-	-

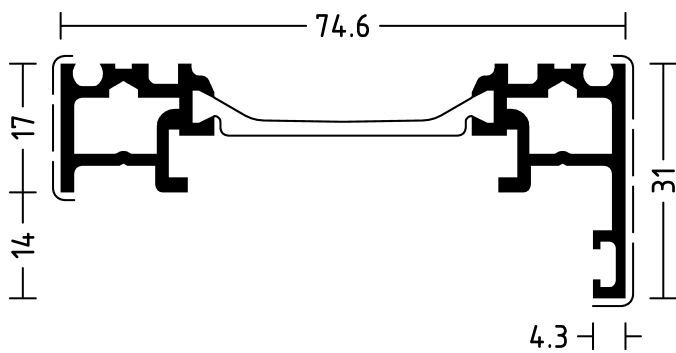



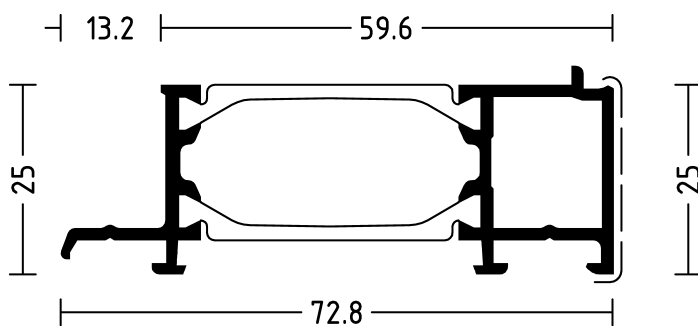



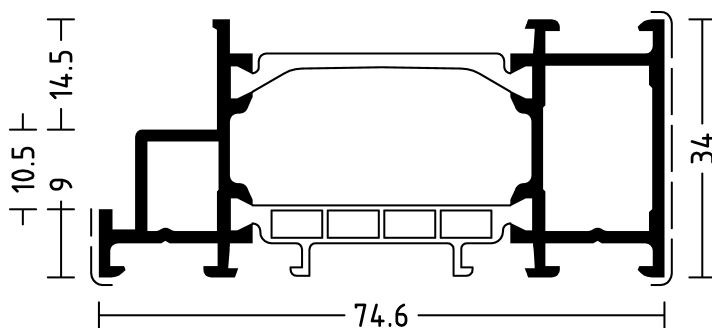







1927530



1927531



1927532

													
	m	mm	mm										
 1010463	6,5	196	1	-	-	-	-	-	-	-	-	-	-
 1010464	6,5	233	6	-	-	-	-	-	-	-	-	-	-

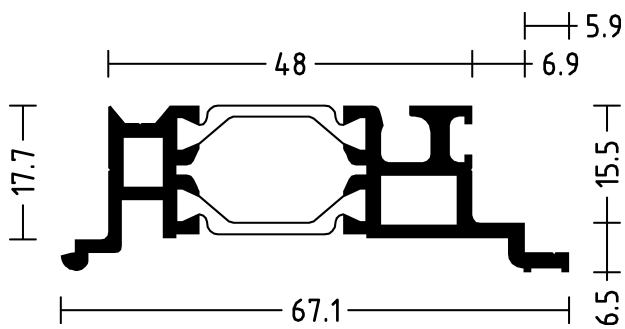

1010463

Verwendung:
Aufsatzprofil für Blendrahmenprofile zur Einspannung in WICTEC Serie
Application:
Supplementary profile of frame profiles for clamping

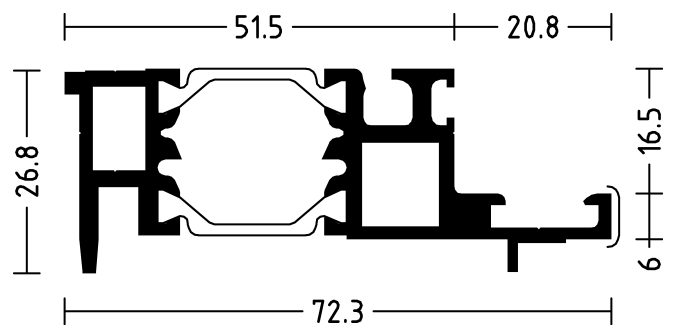

1010464

Verwendung:
Aufsatzprofil für Blendrahmenprofile zur Einspannung in WICTEC Serie
Application:
Supplementary profile of frame profiles for clamping

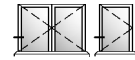
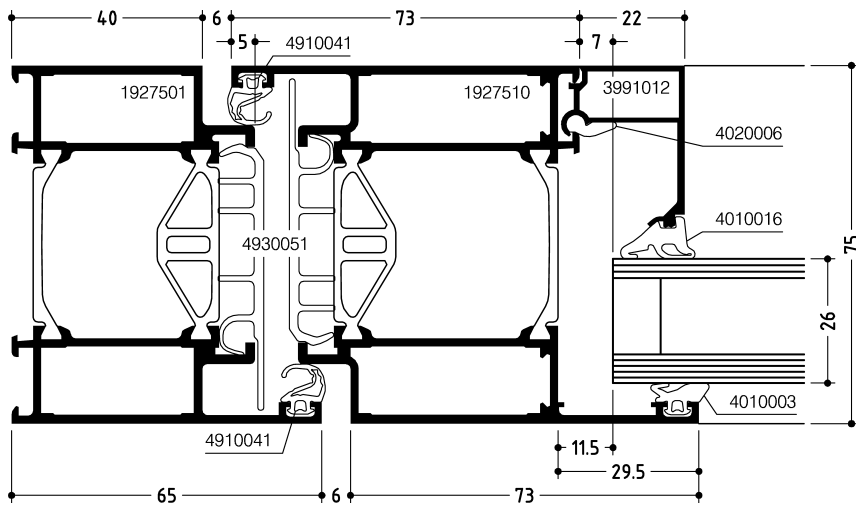

DOC-0000681242

Anschlagtüren
einwärts mit Spezi-
alblendrahmen
*Hinged doors
inwards with
special frame*

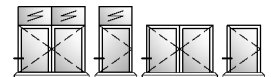
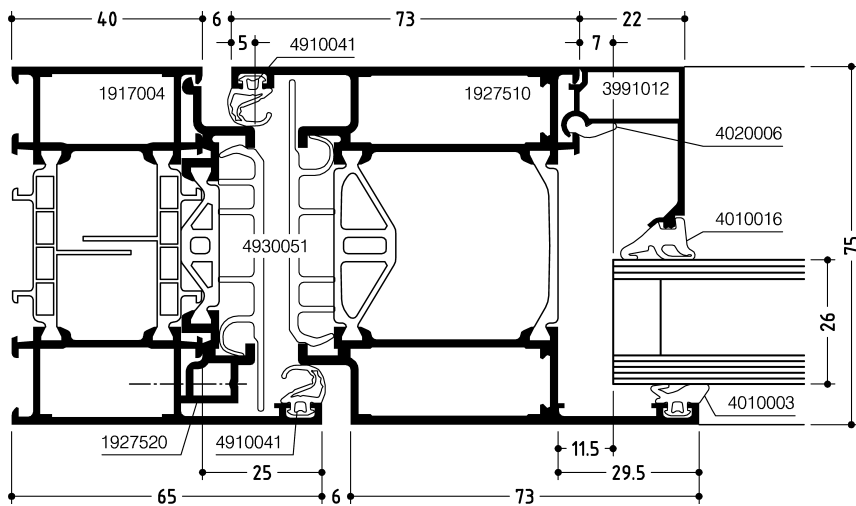

DOC-0000681265

Anschlagtüren
einwärts mit
Kombinations-
blendrahmen
*Hinged doors
inwards with
combination frame*

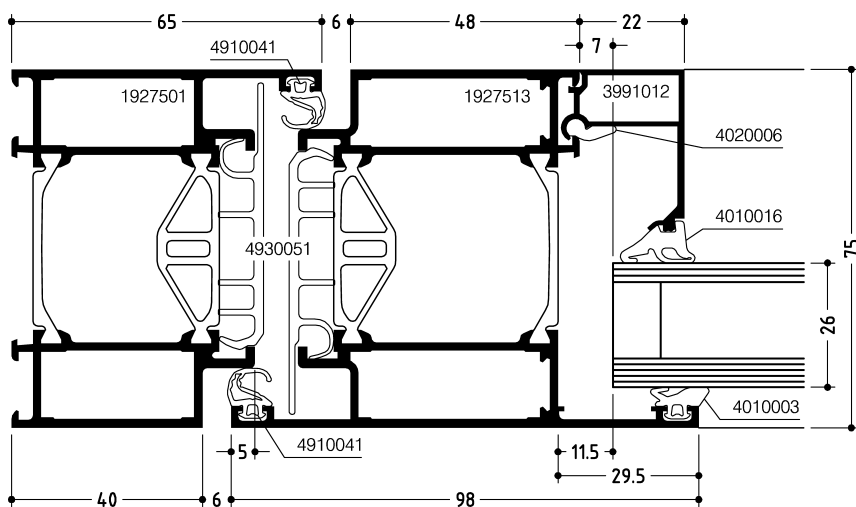

DOC-0000681336

Anschlagtüren
auswärts mit Spezi-
alblendrahmen
*Hinged doors
outwards with
special frame*

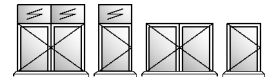
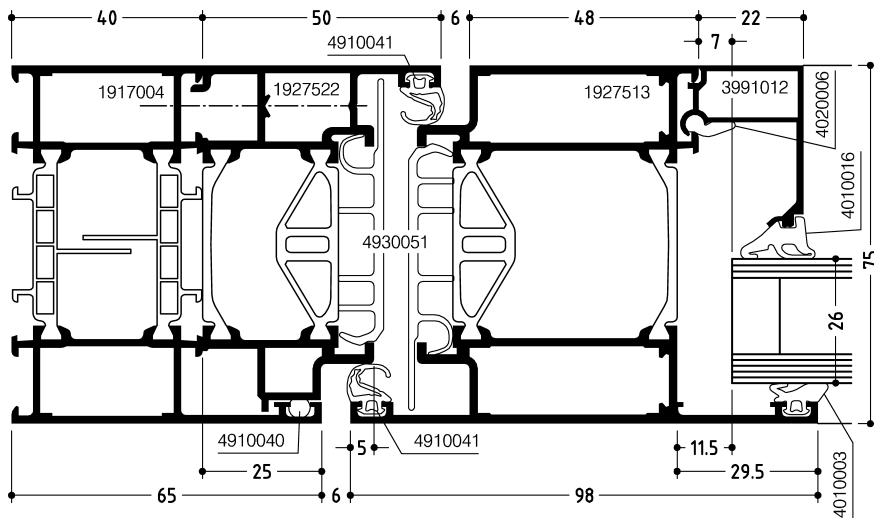

DOC-0000681375

Anschlagtüren
auswärts mit
Kombinations-
blendrahmen
*Hinged doors
outwards with
combination frame*

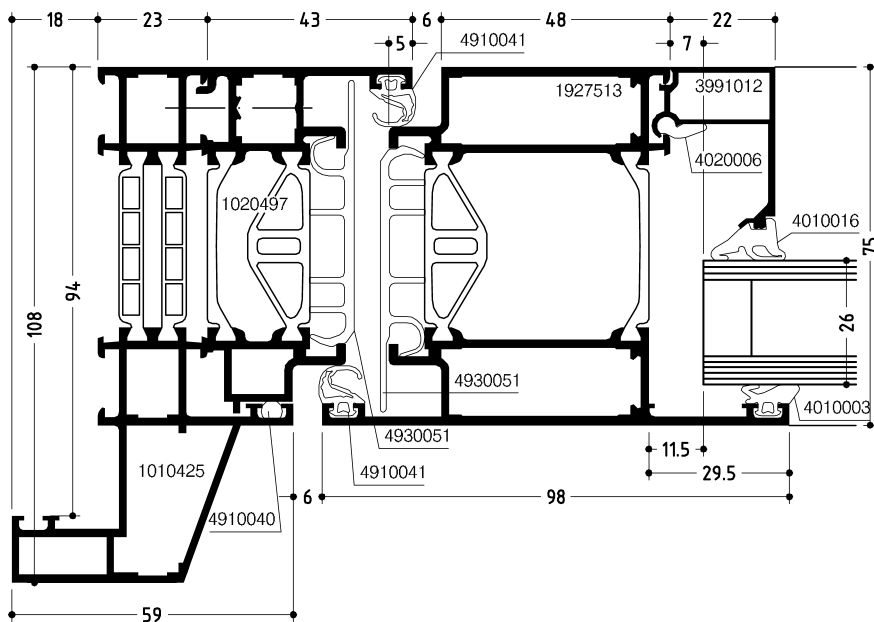

DOC-0000922672

Anschlagtür
auswärts mit
Kombinations-
blendrahmen
*Hinged doors
outwards with
combination frame*

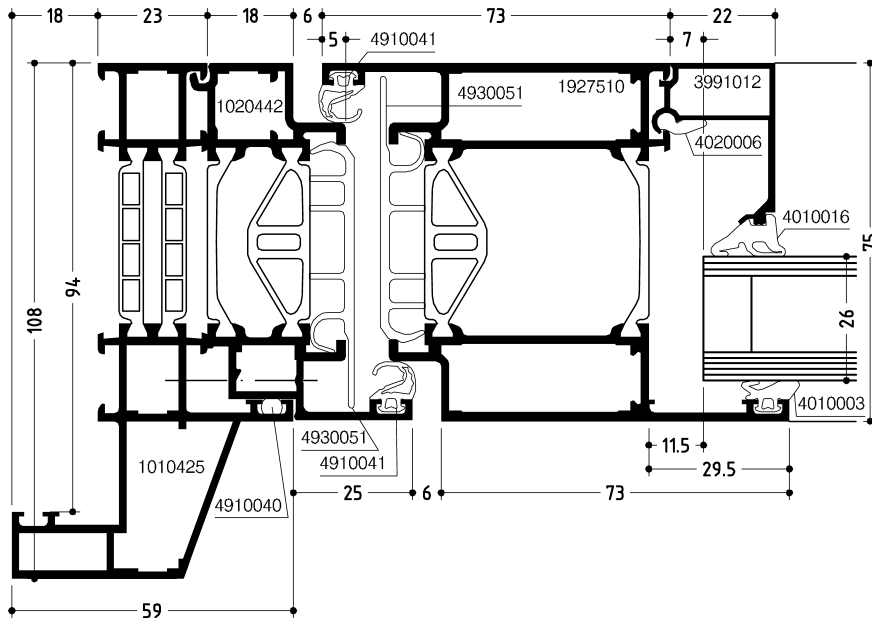

DOC-0000922650

Anschlagtüren
einwärts mit Kombi-
blendrahmen

*Hinged doors
inwards with
combination frame*

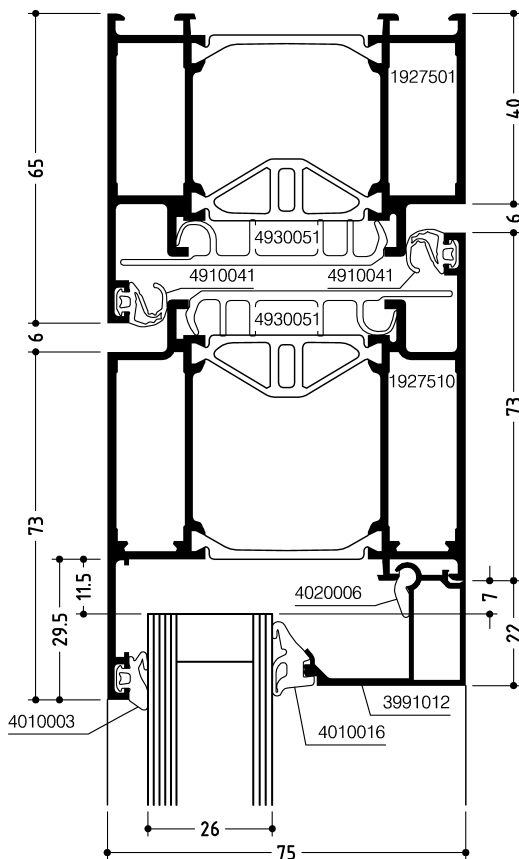

DOC-0000681519

Anschlagtüren
einwärts mit Spezi-
alblendrahmen

*Hinged doors
inwards with
special frame*

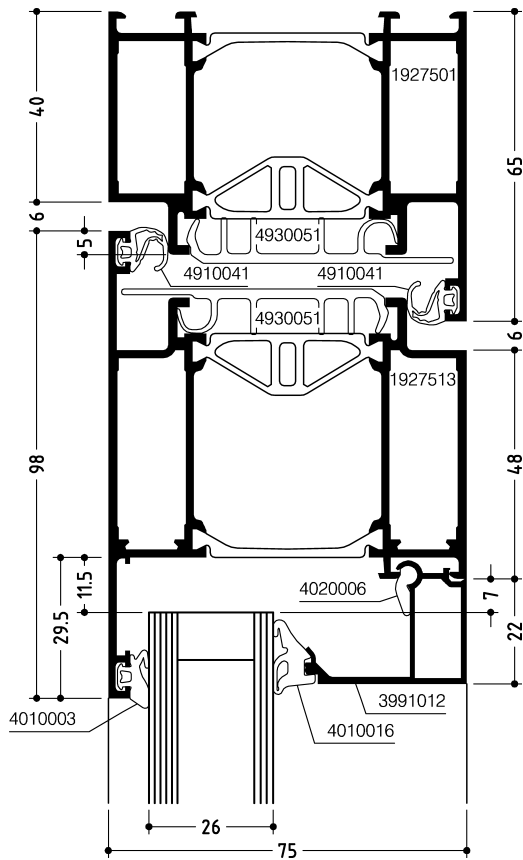

DOC-0000681731

Anschlagtüren
auswärts mit
Spezial- blendrah-
men

*Hinged doors
outwards with
special frame*

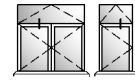
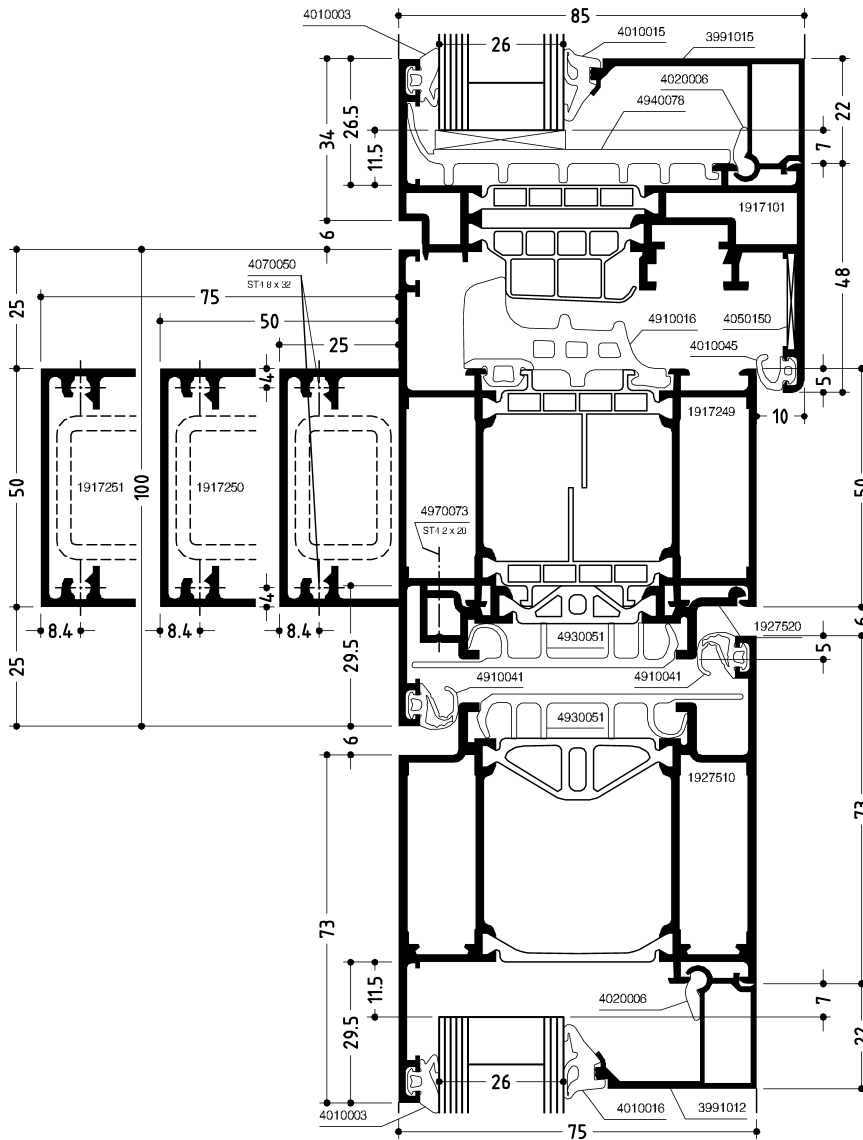

DOC-0000682642

Anschlagtüren
einwärts mit
Kämpferprofil nach
außen verstärkt

*Hinged doors
inwards with
externally
reinforced transom
profile*

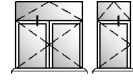
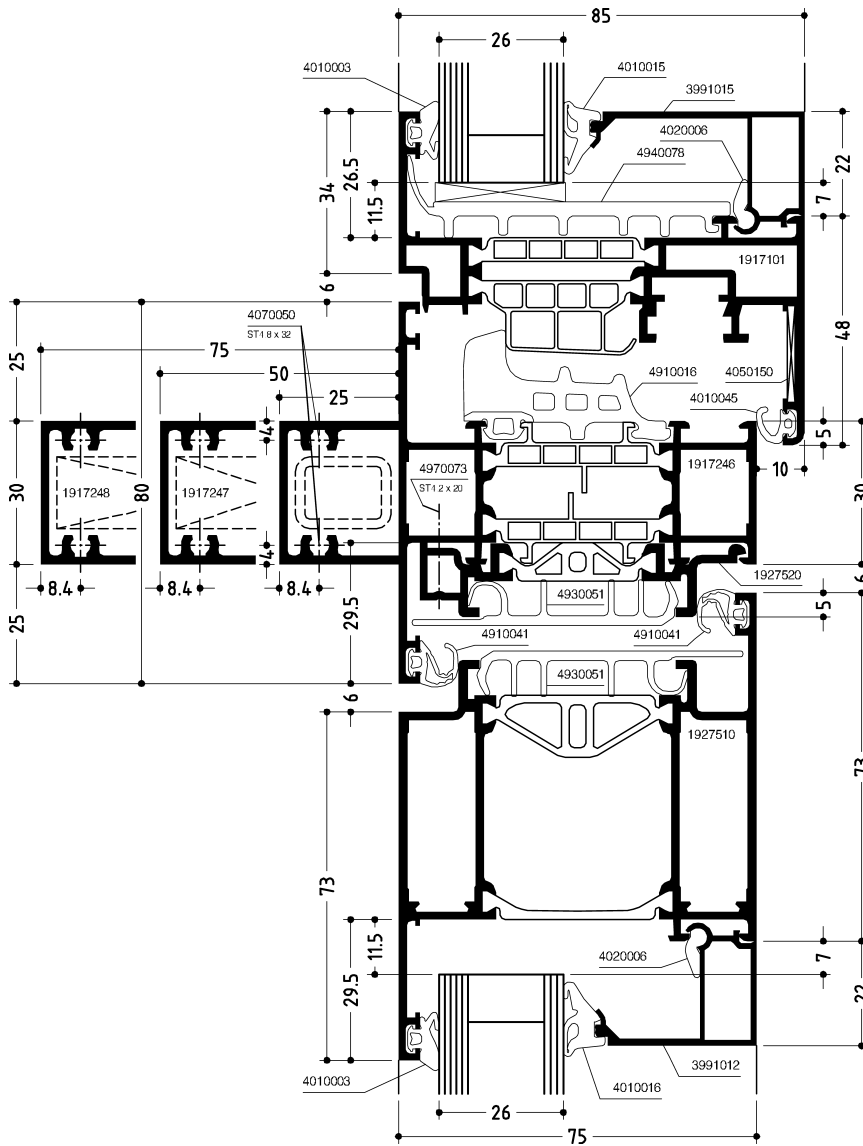

DOC-0000682126

Anschlagtüren
einwärts mit
Kämpferprofil nach
außen verstärkt

*Hinged doors
inwards with
externally
reinforced transom
profile*

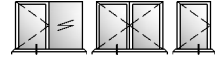
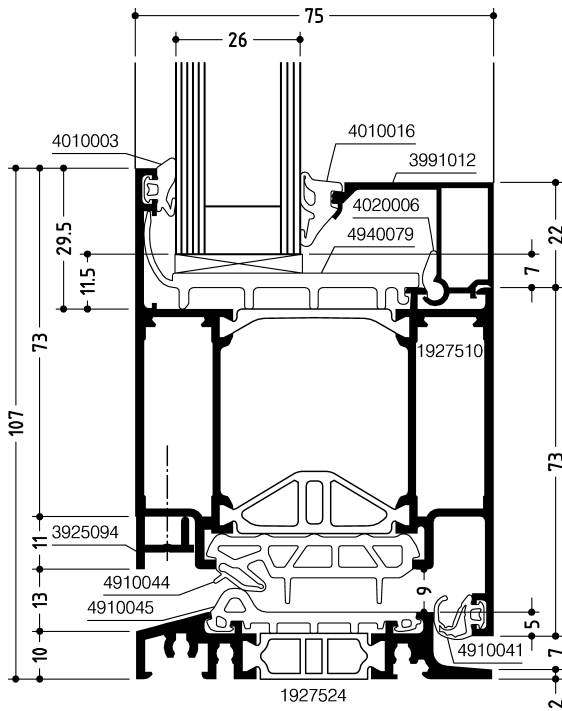

DOC-0000682977

Anschlagtüren
einwärts mit Flügel-
profil umlaufend
*Hinged doors
inwards with
circumferential leaf
profile*

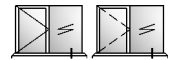
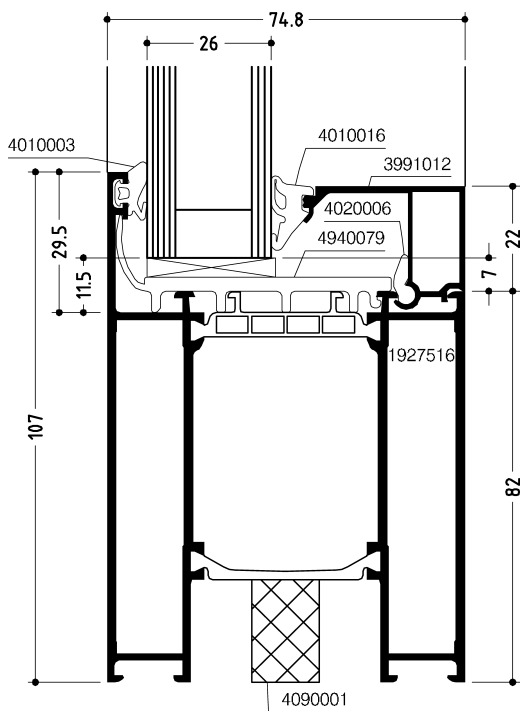

DOC-0000683144

Festfeld mit Sockel-
profil
*Fixed field with
bottom rail profile*

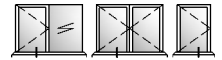
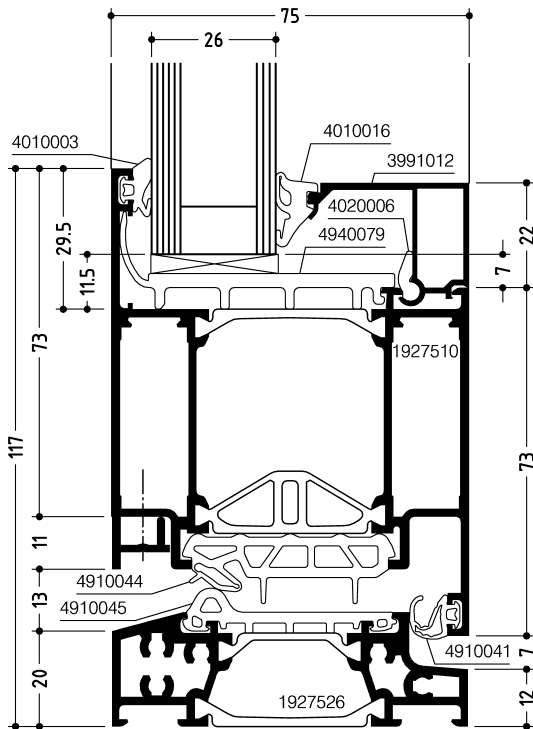

DOC-0000683204

Anschlagtüren
einwärts mit Flügel-
profil umlaufend
*Hinged doors
inwards with
circumferential leaf
profile*

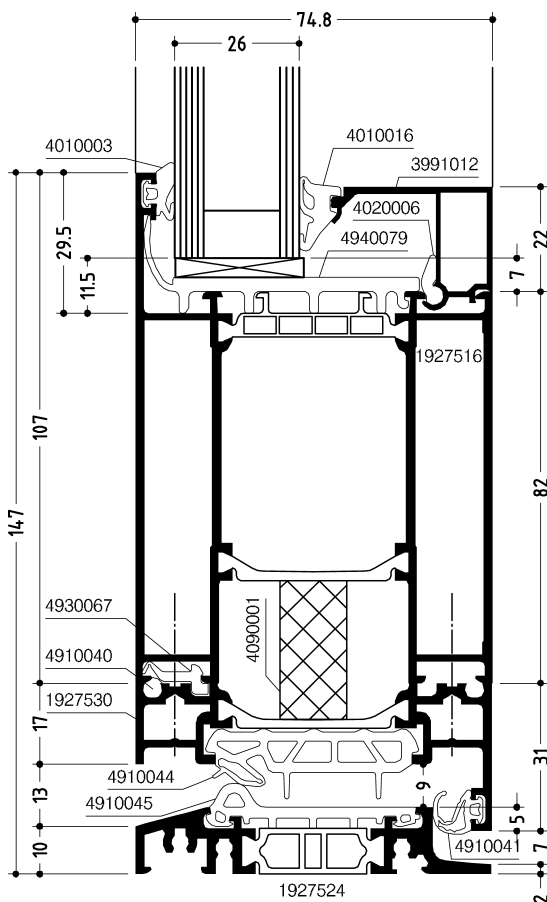

DOC-0000683293

Anschlagtüren
einwärts mit
Sockelprofil
*Hinged doors
inwards with
bottom rail profile*

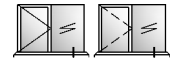
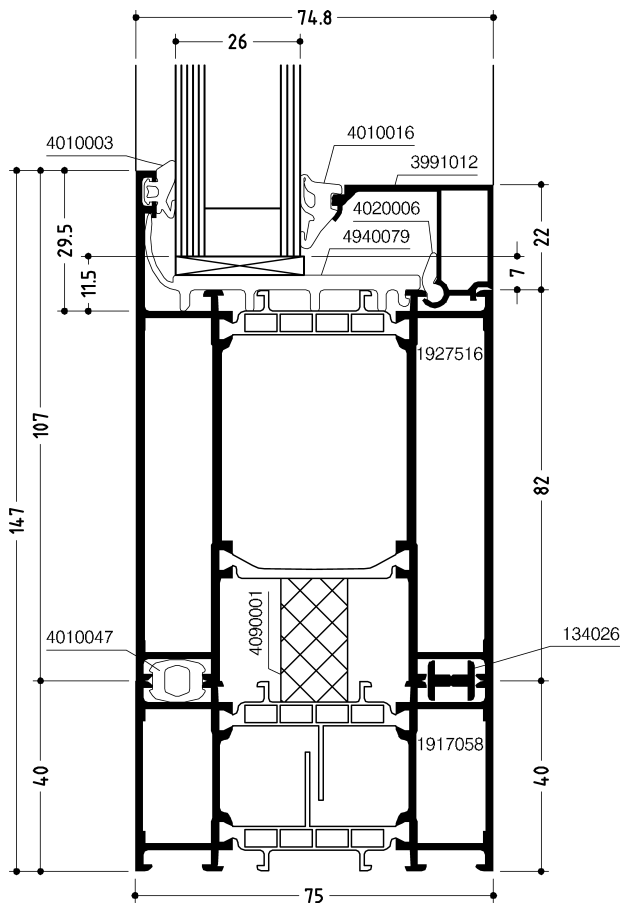

DOC-0000683357

Festfeld mit Sockel-
und Aufsatzprofil
*Fixed field with
bottom rail and
supplementary
profile*

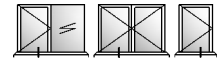
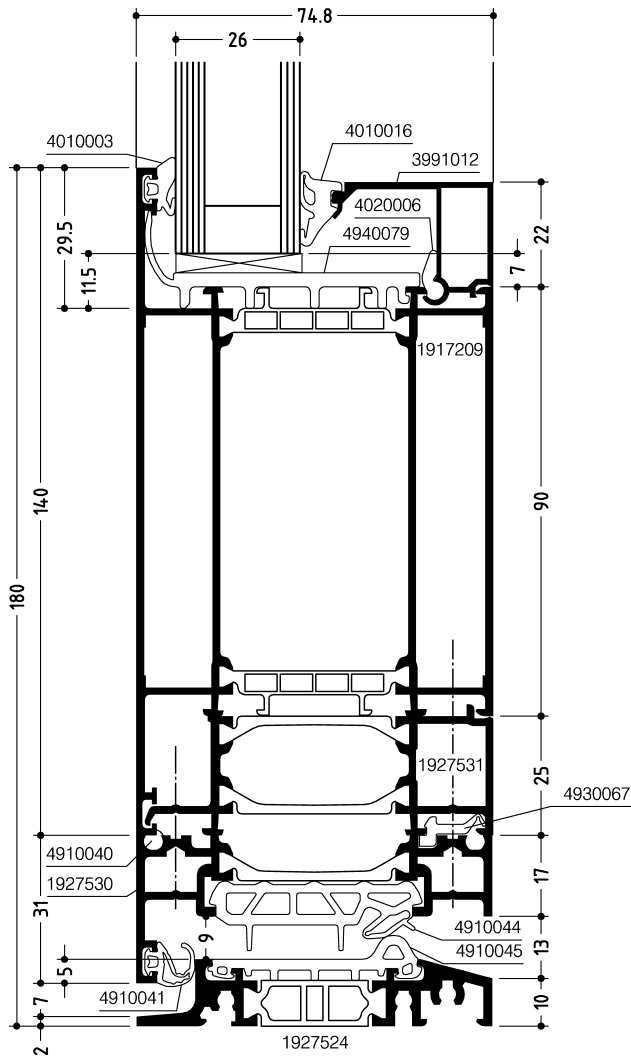

DOC-0000683468

Anschlagtüren
auswärts mit
Kämpfer- und
Aufsatzprofil als
Kämpfersockel
*Hinged doors
outwards with
transom as
bottom rail and
supplementary
profile*

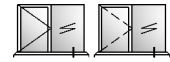
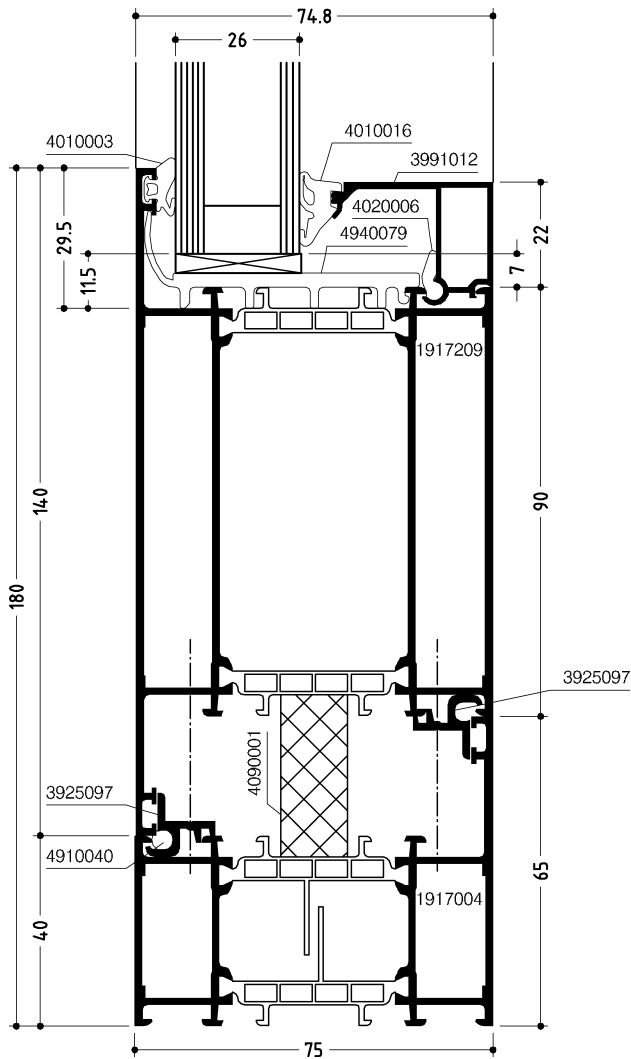

DOC-0000683487

Festfeld mit Kämpfersockel und
Blendrahmenprofil
*Fixed field with
transom as bottom
rail and frame
profile*

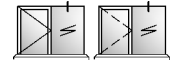
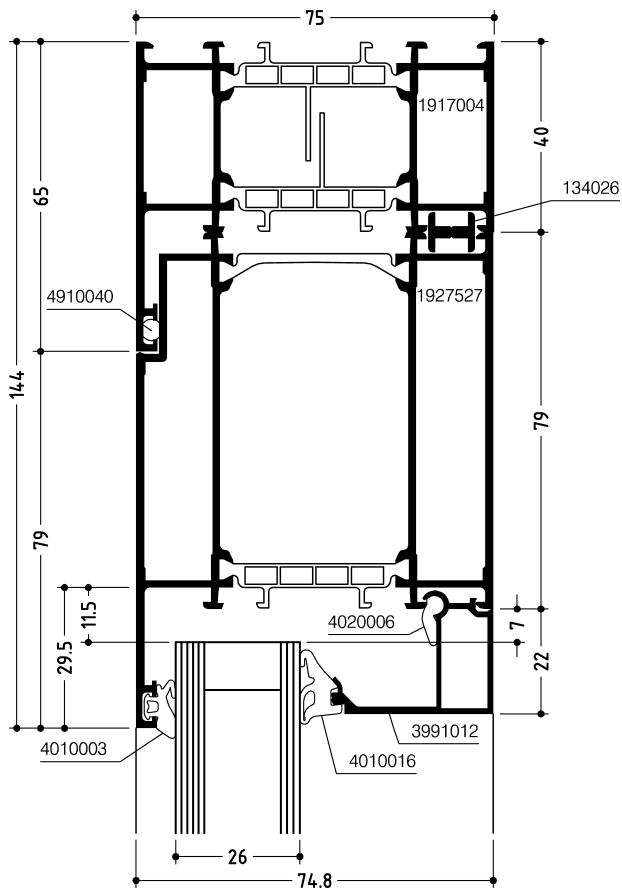

DOC-0000683553

Festfeld mit Falz-
verbreiterungs-
profil

*Fixed field with
rebate widening
profile*

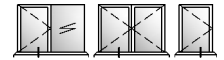
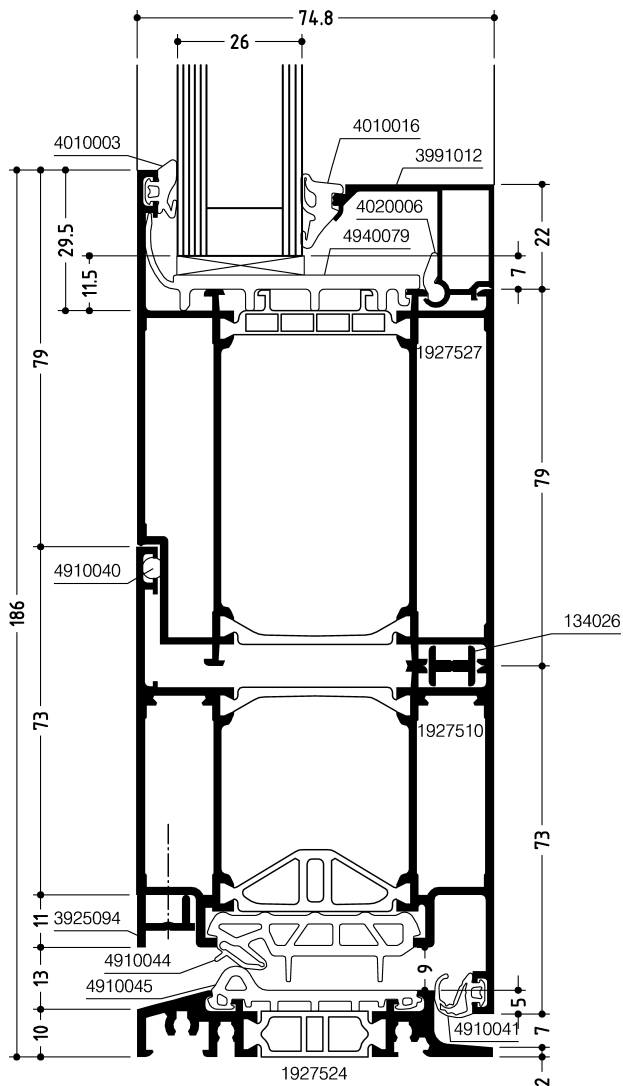

DOC-0000683582

Anschlagtüren
einwärts mit Flügel-
profil umlaufend
und Falzverbreiter-
ungsprofil

*Hinged doors
inwards with
circumferential leaf
profile and rabate
widening profi*

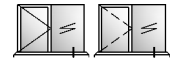
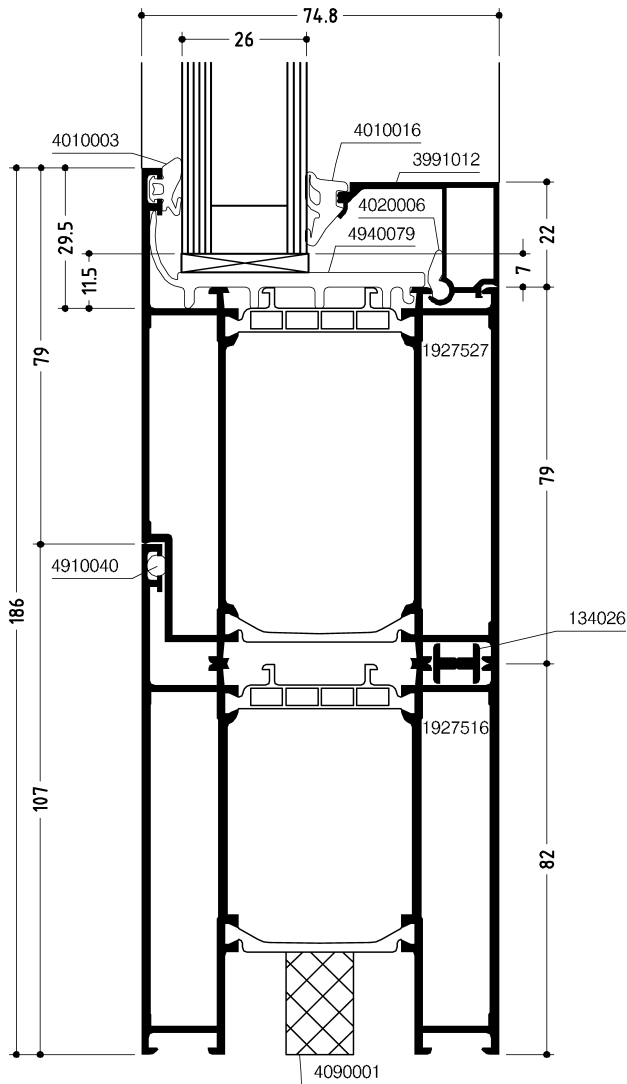

DOC-0000683590

Festfeld mit Sockel-
und Falzverbreiter-
ungsprofil

*Fixed field with
bottom rail and
rebate widening
profile*

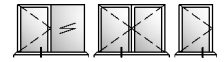
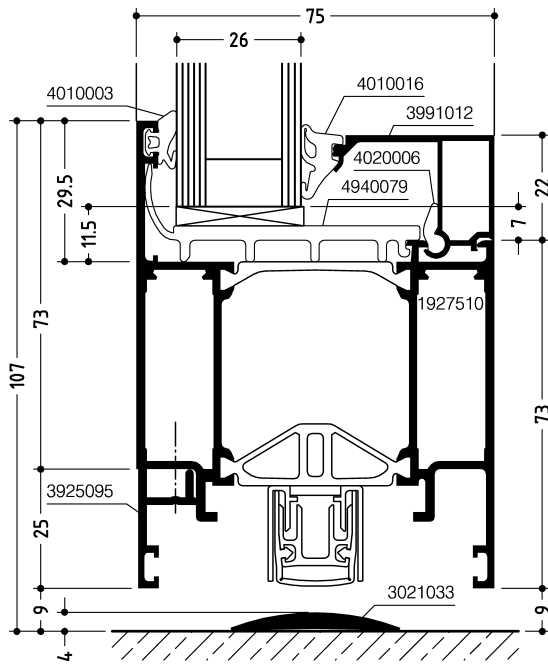

DOC-0000691103

Anschlagtüren
einwärts mit Flügel-
profil umlaufend
*Hinged doors
inwards with
circumferential leaf
profile*

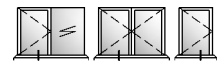
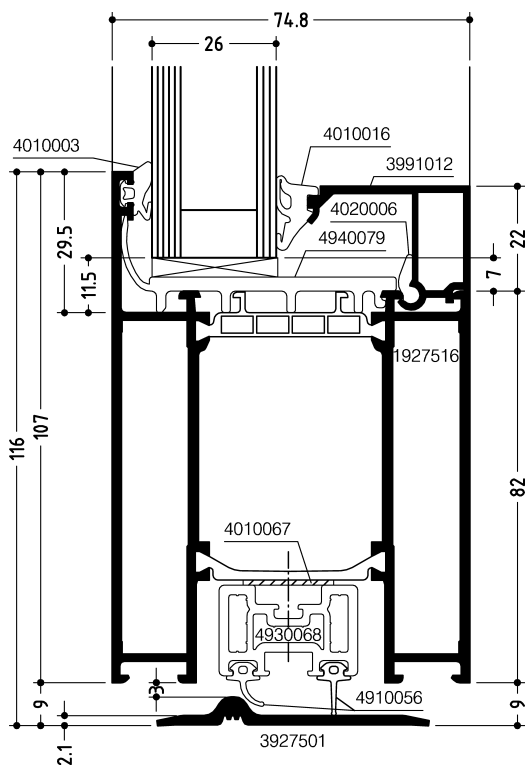

DOC-0000683625

Anschlagtüren
einwärts mit
Sockelprofil
*Hinged doors
inwards with
bottom rail profile*

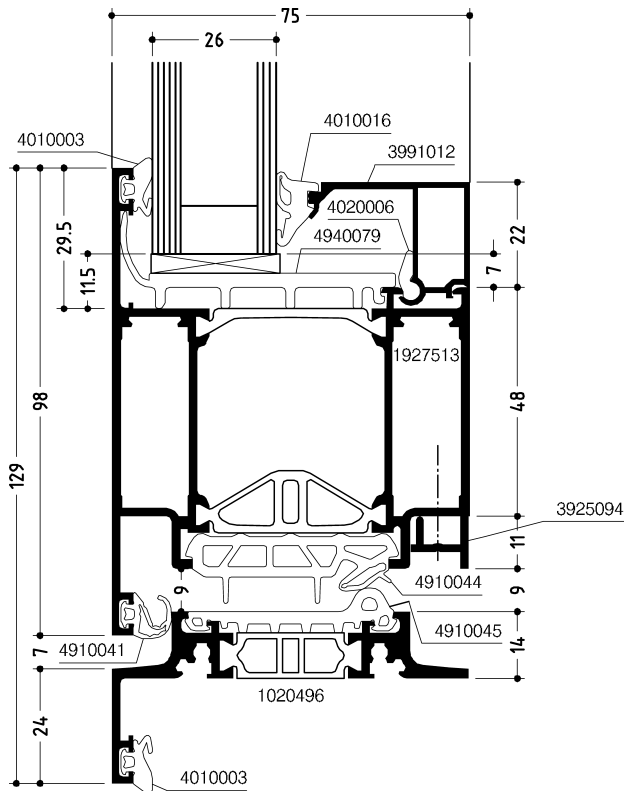

DOC-0000911865

Anschlagtüren
auswärts mit
Flügelprofil umlau-
fend

*Hinged doors
outwards with
circumferential leaf
profile*

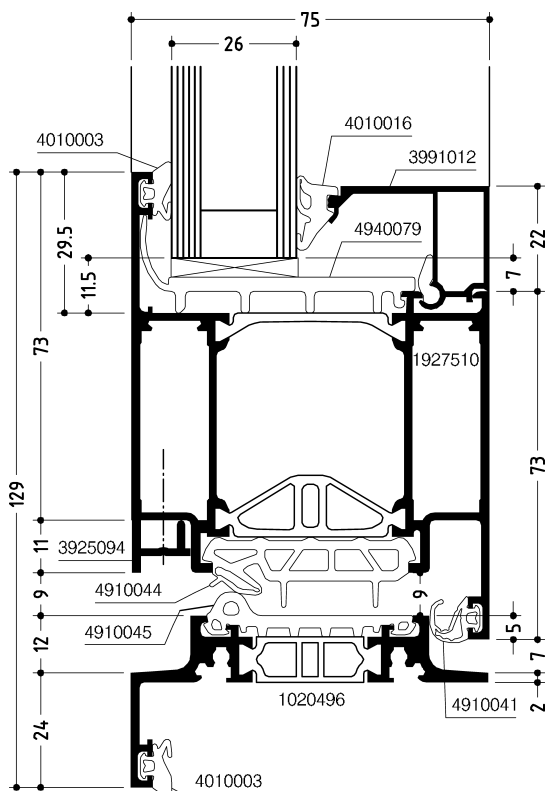

DOC-0000911889

Anschlagtüren
einwärts mit Flügel-
profil umlaufend

*Hinged doors
outwards with
circumferential leaf
profile*

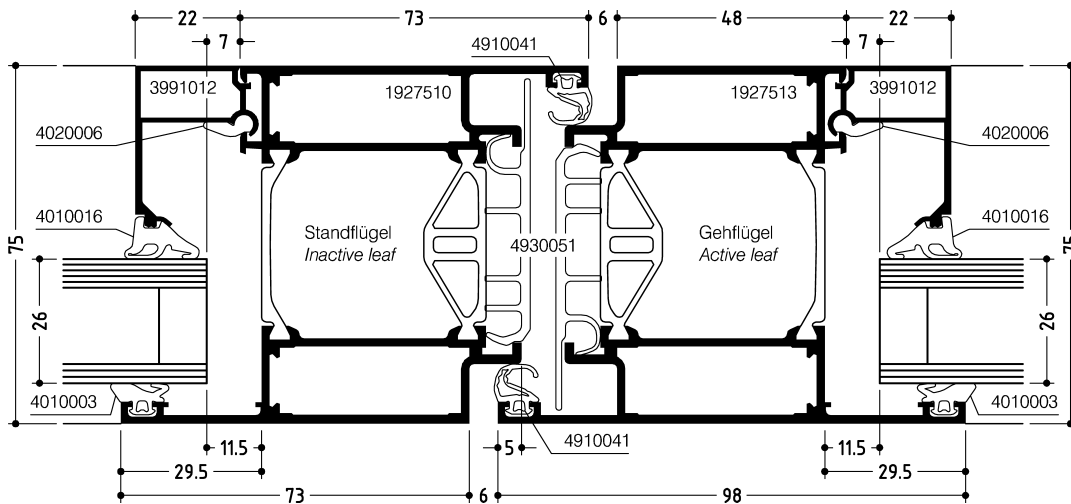

DOC-0000683679

Anschlagtüren
auswärts, Mittel-
stoß ohne Aufsatz-
profil

*Hinged doors
outwards, meeting
stiles without
supplementary
profile*

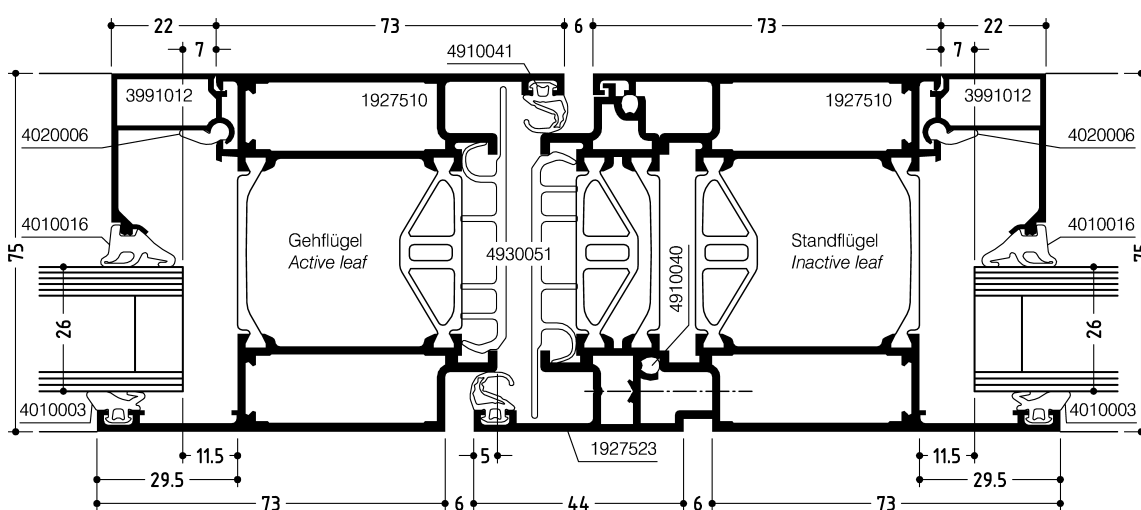

DOC-0000683737

Anschlagtüren
einwärts, Mittelstoß
mit Aufsatzprofil

*Hinged doors
inwards, meeting
stiles with
supplementary
profile*

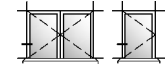
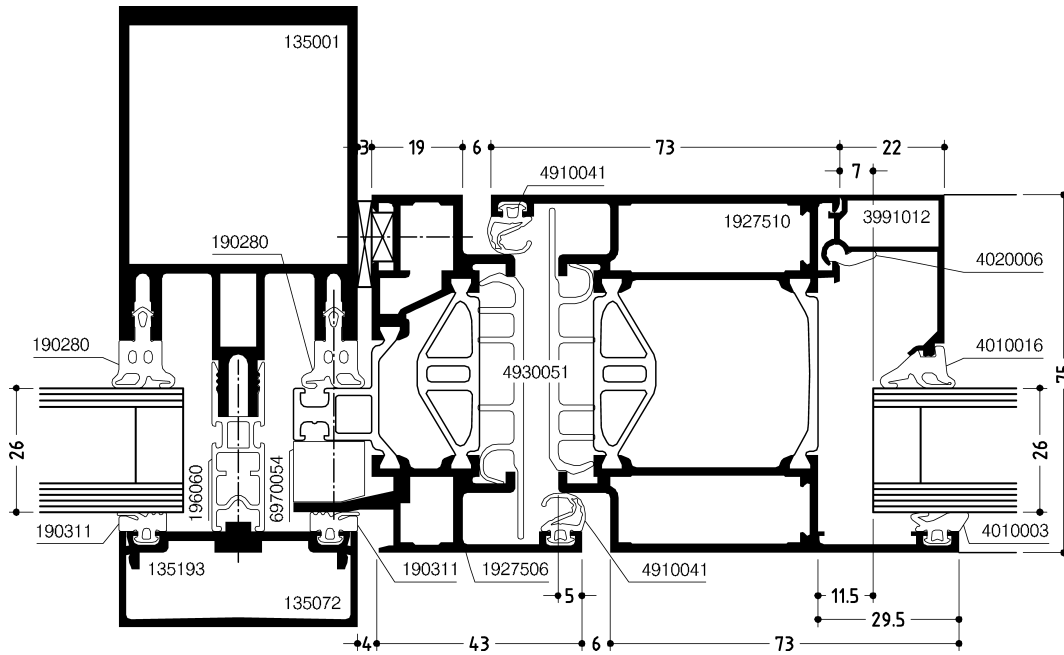

DOC-0000683965

Anschlagtüren
einwärts mit
Einspannblendrah-
men, kombiniert
mit WICTEC 50

*Hinged doors
inwards with
clamping frame
profile combined
with WICTEC 50*

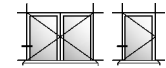
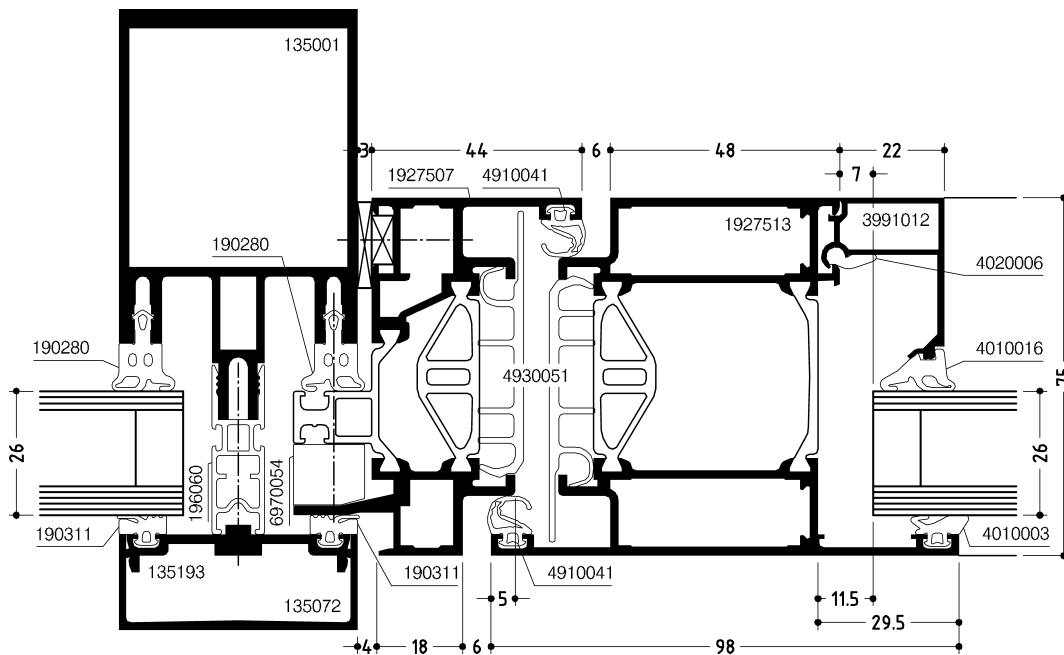

DOC-0000683994

Anschlagtüren
auswärts mit
Einspannblendrah-
men, kombiniert
mit WICTEC 50

*Hinged doors
outwards with
clamping frame
profile combined
with WICTEC 50*

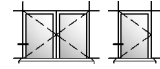
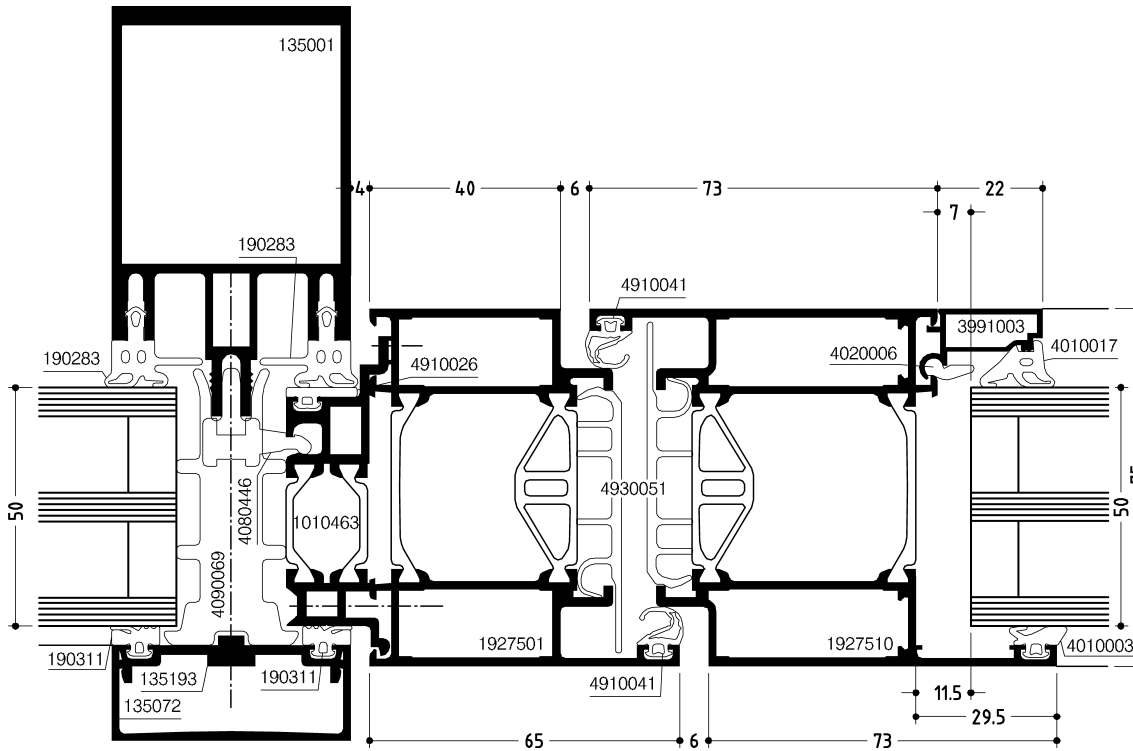

DOC-0001015339

Anschlagtüren
einwärts mit
Einspannaufsatz-
profil und Befesti-
gungsteil
*Hinged doors
inwards with
supplementary
clamping profile
and fixing part*

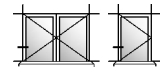
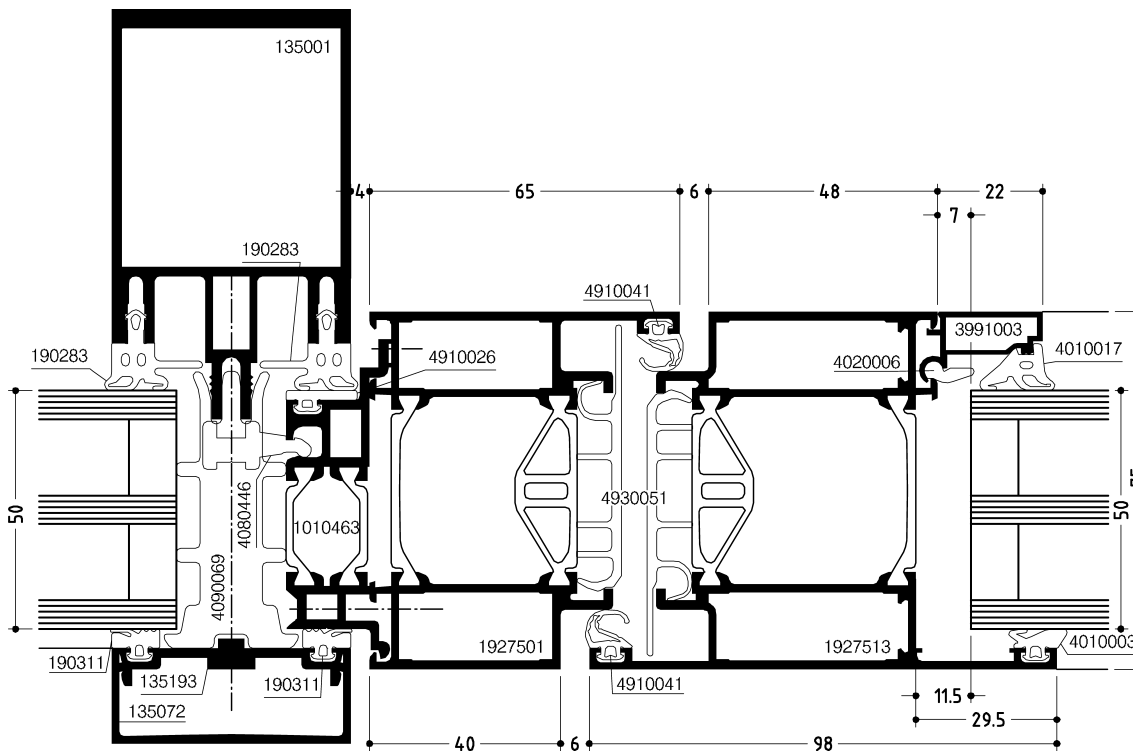

DOC-0001015495

Anschlagtüren
auswärts mit
Einspannaufsatz-
profil und Befesti-
gungsteil
*Hinged doors
outwards with
supplementary
clamping profile
and fixing part*

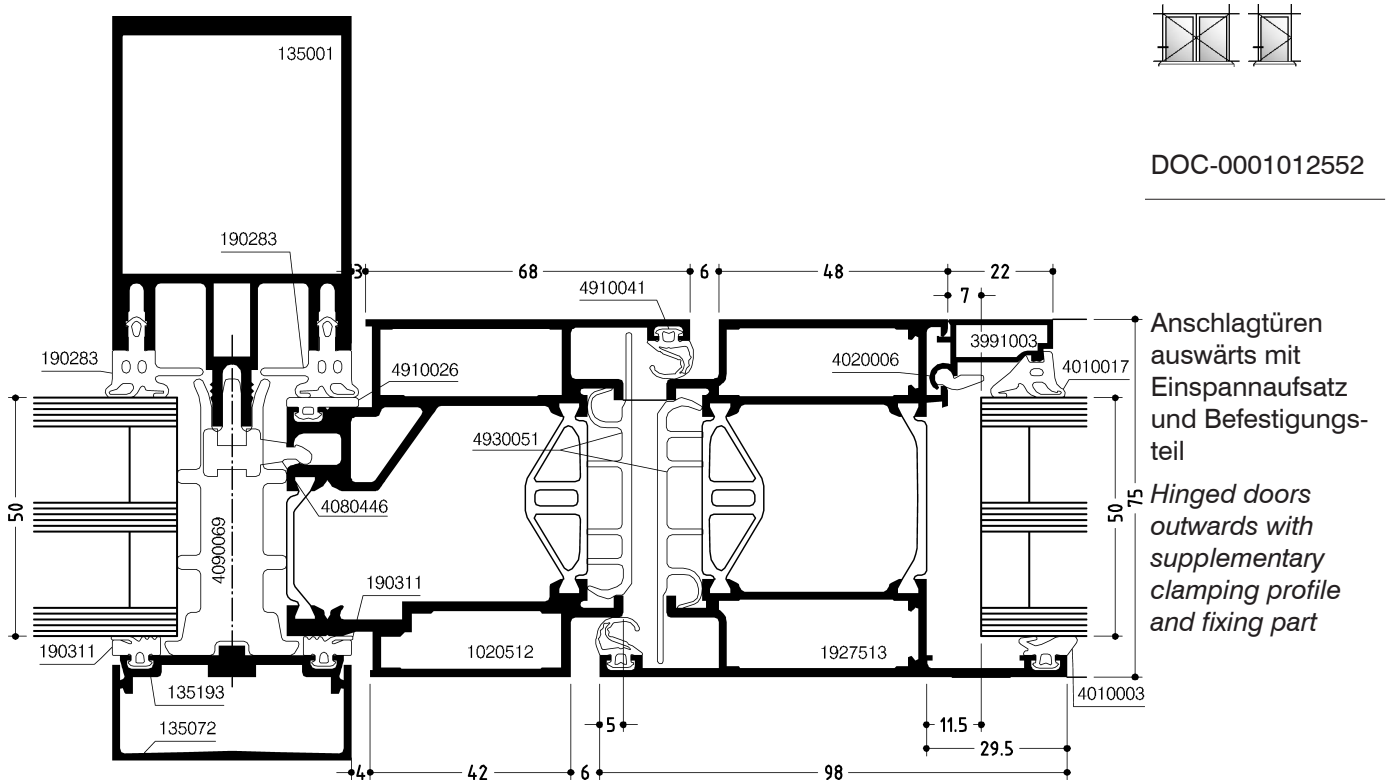
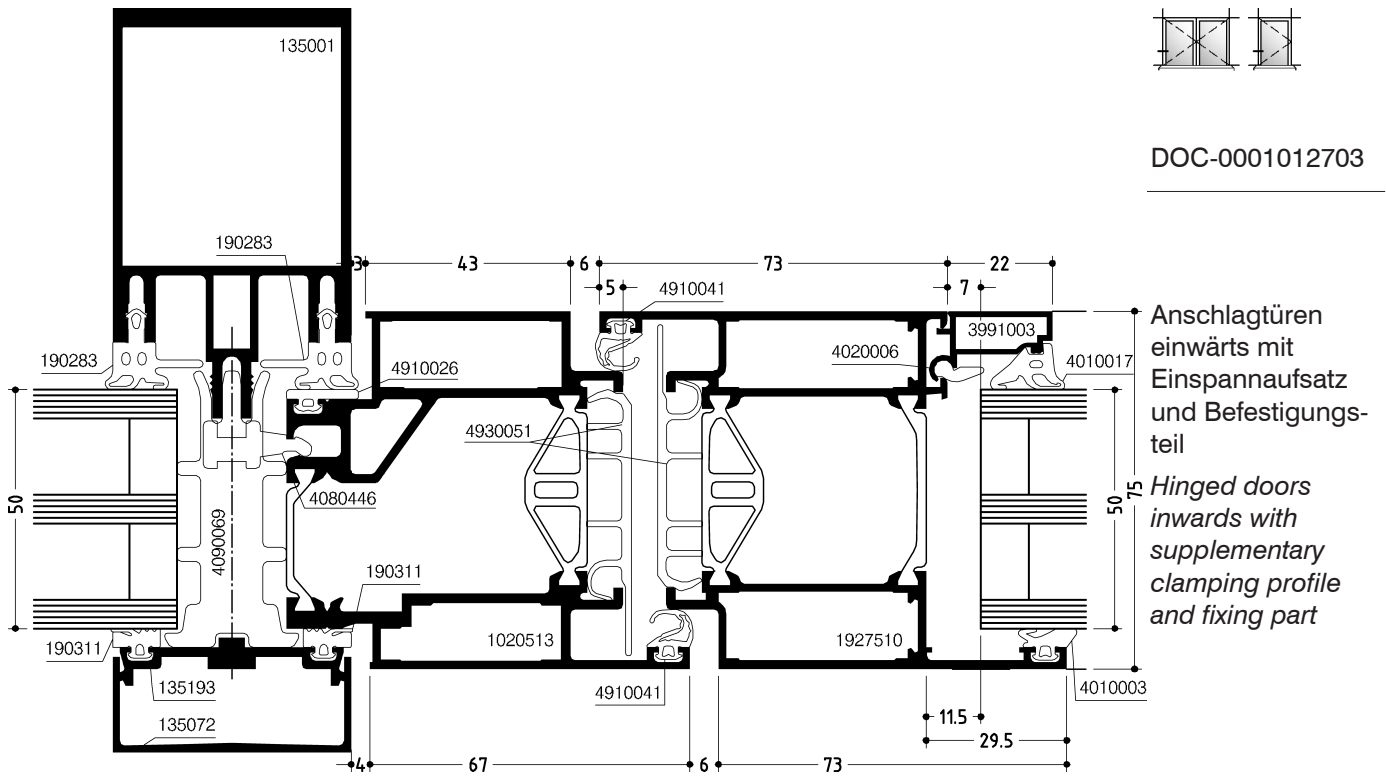

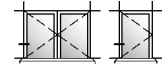
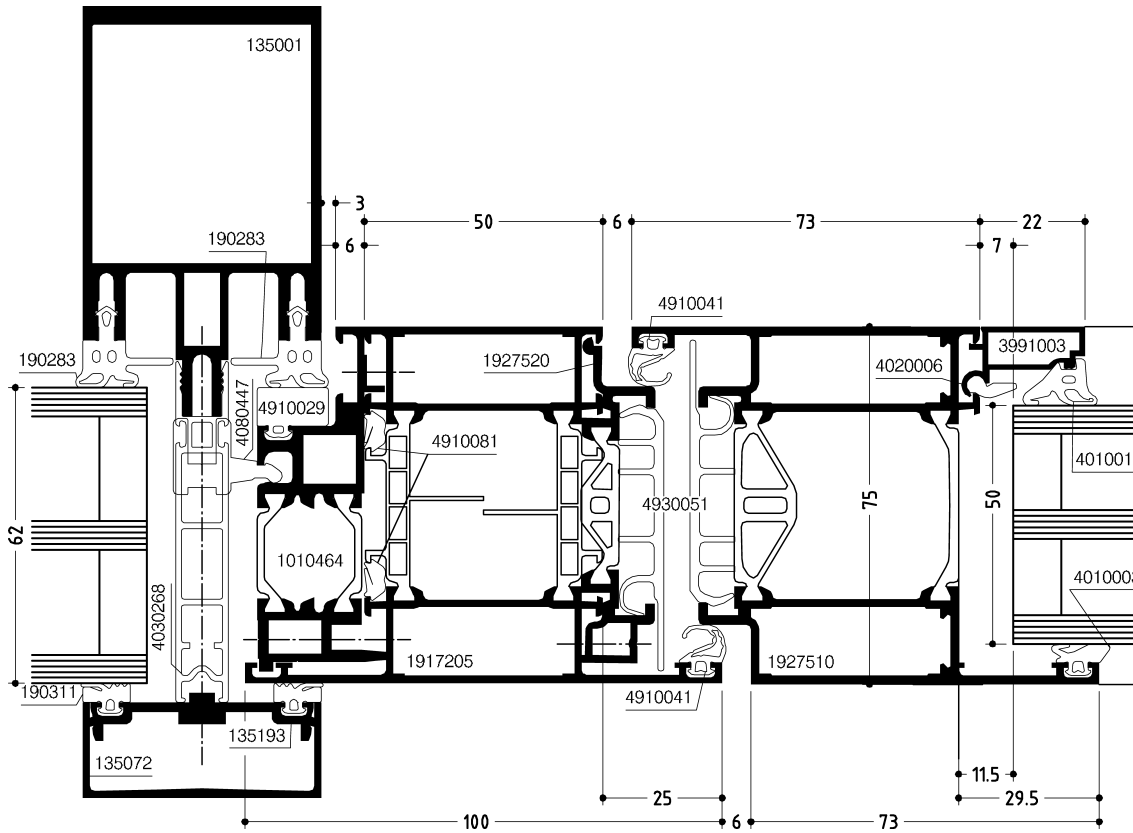

DOC-0001015528

Anschlagtüren
einwärts mit
Einspannaufsatz-
profil und Befesti-
gungsteil
*Hinged doors
inwards with
supplementary
clamping profile
and fixing part*

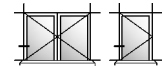
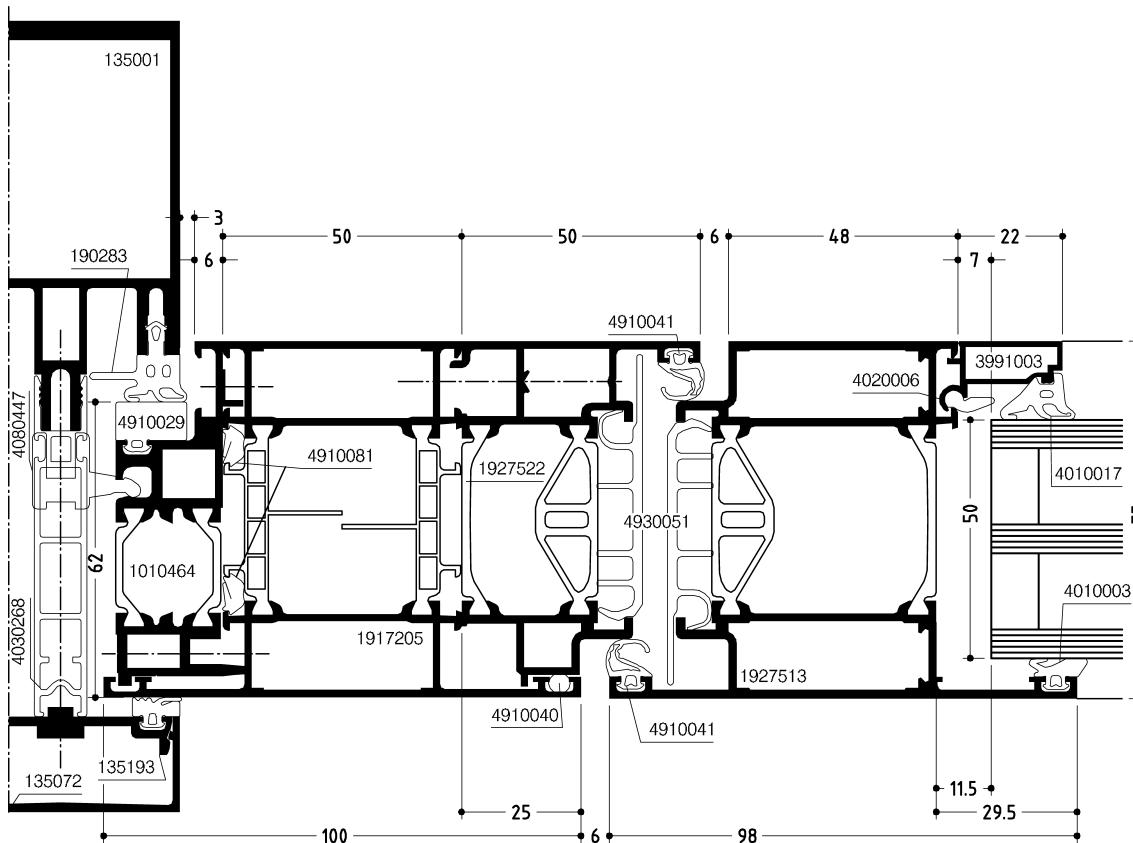

DOC-0001015747

Anschlagtüren
auswärts mit
Einspannaufsatz-
profil und Befesti-
gungsteil
*Hinged doors
outwards with
supplementary
clamping profile
and fixing part*

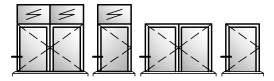
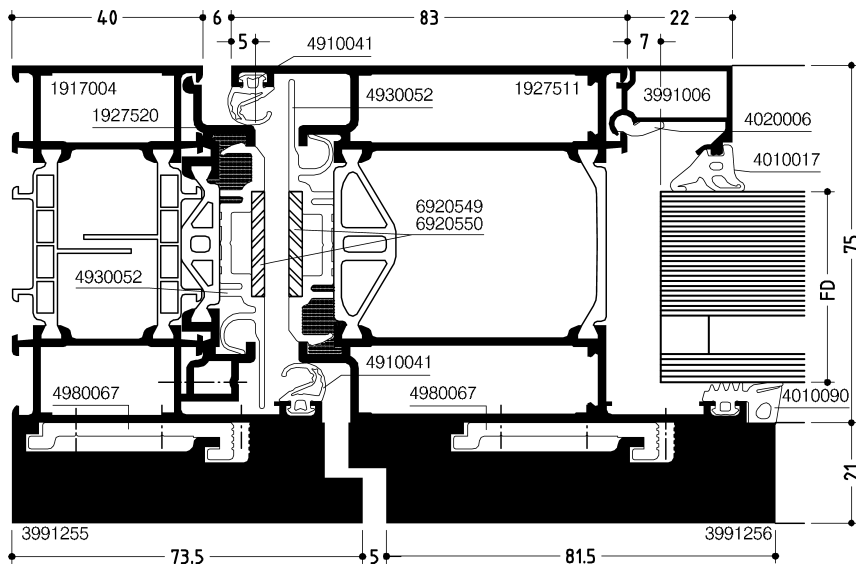

DOC-0000784668

Anschlagtüren
einwärts mit Kombi-
nationsblendrah-
men, Bandseite

*Hinged doors
inwards with
combination frame,
Hinge side*

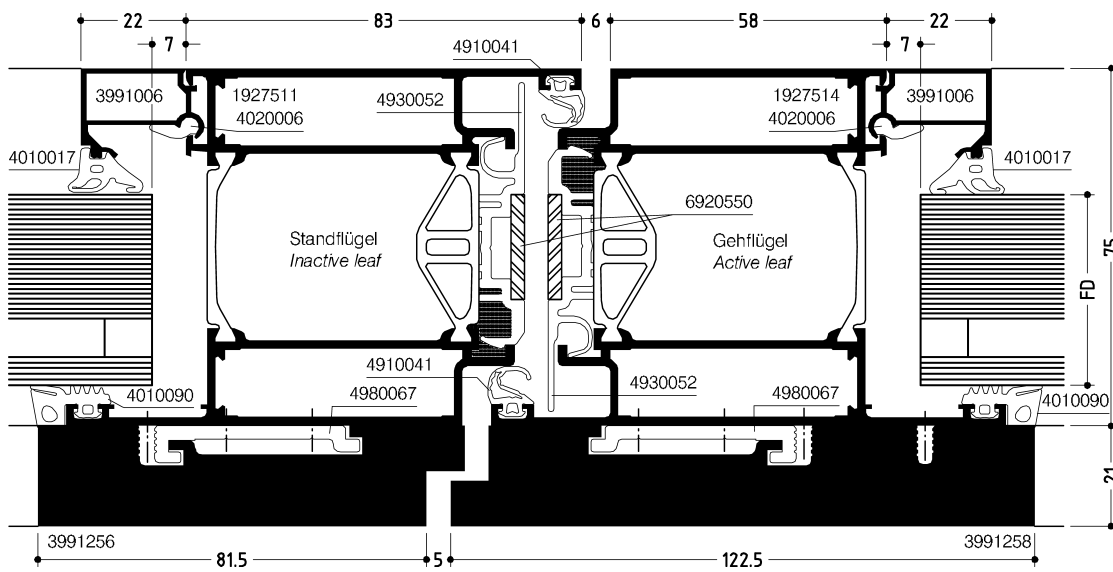

DOC-0000784678

Anschlagtüren
einwärts, Mittelstoß
ohne Aufsatzprofil
Stulptüre

*Hinged doors
inwards, meeting
stiles without
supplementary
profile Double
casement door*

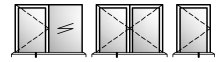
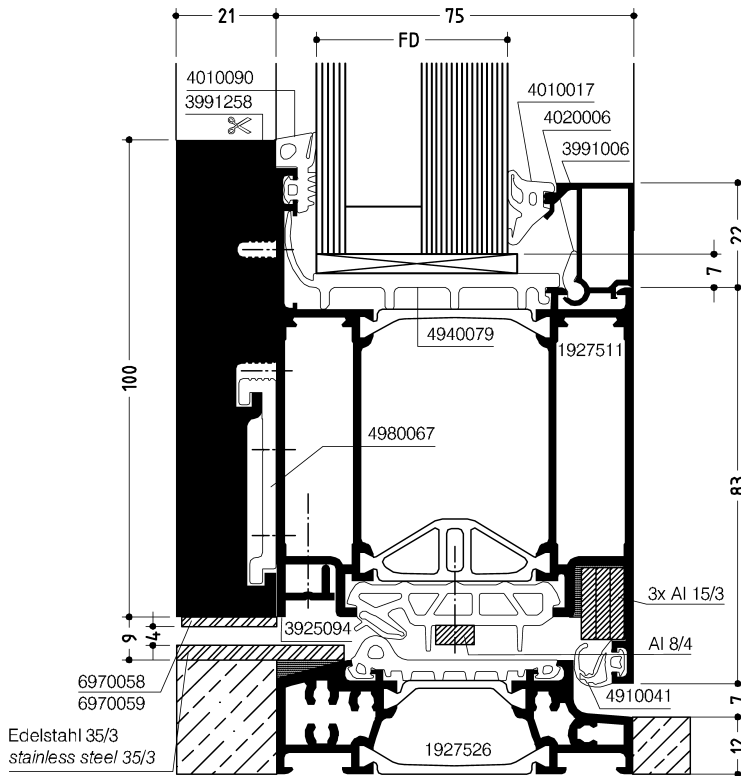

DOC-0000786710

Anschlagtüren
einwärts mit Flügel-
profil umlaufend
Türsockel

*Hinged doors
inwards with
circumferential leaf
profile Bottom rail*

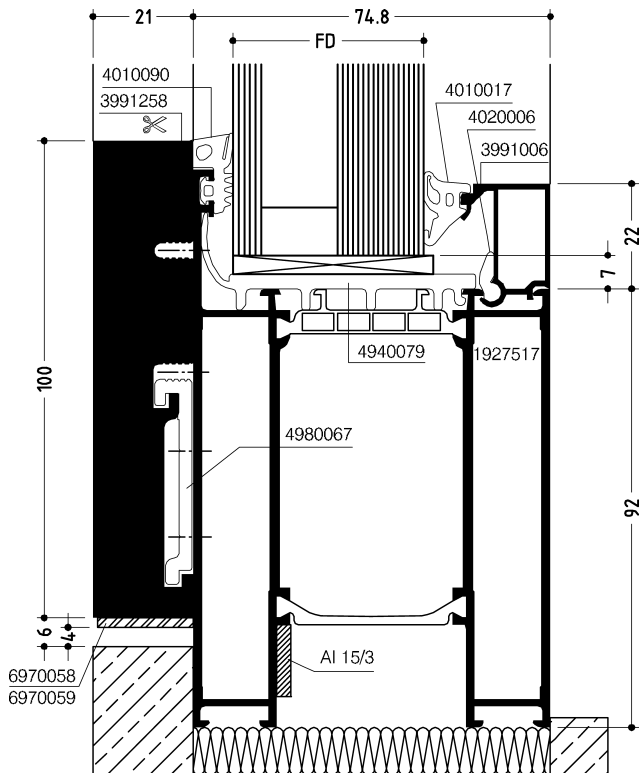

DOC-0000786852

Anschlagtüren
einwärts mit Flügel-
profil umlaufend
Festfeldsockel

*Hinged doors
inwards with
circumferential leaf
profile Fixed field
bottom rail*

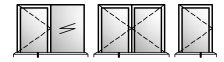
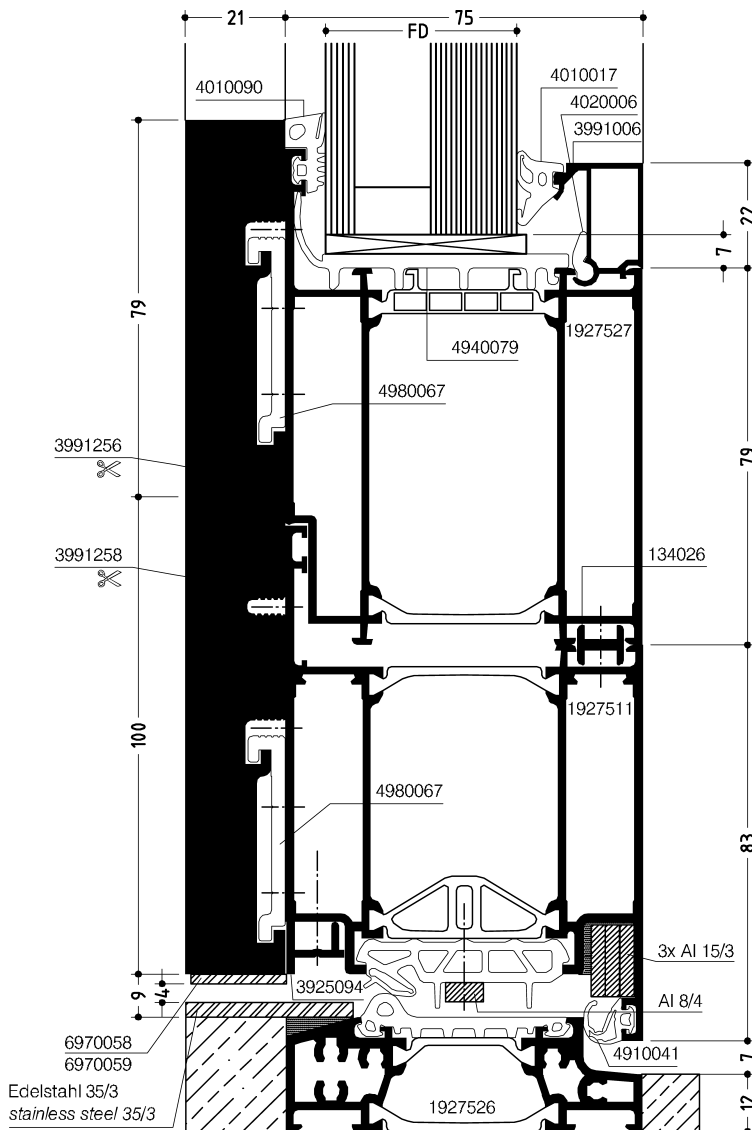

DOC-0000850957

Anschlagtüren
einwärts mit Flügel-
profil umlaufend,
Türsockel

*Hinged doors
inwards with
circumferential leaf
profile, Bottom rail*

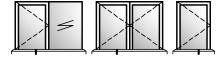
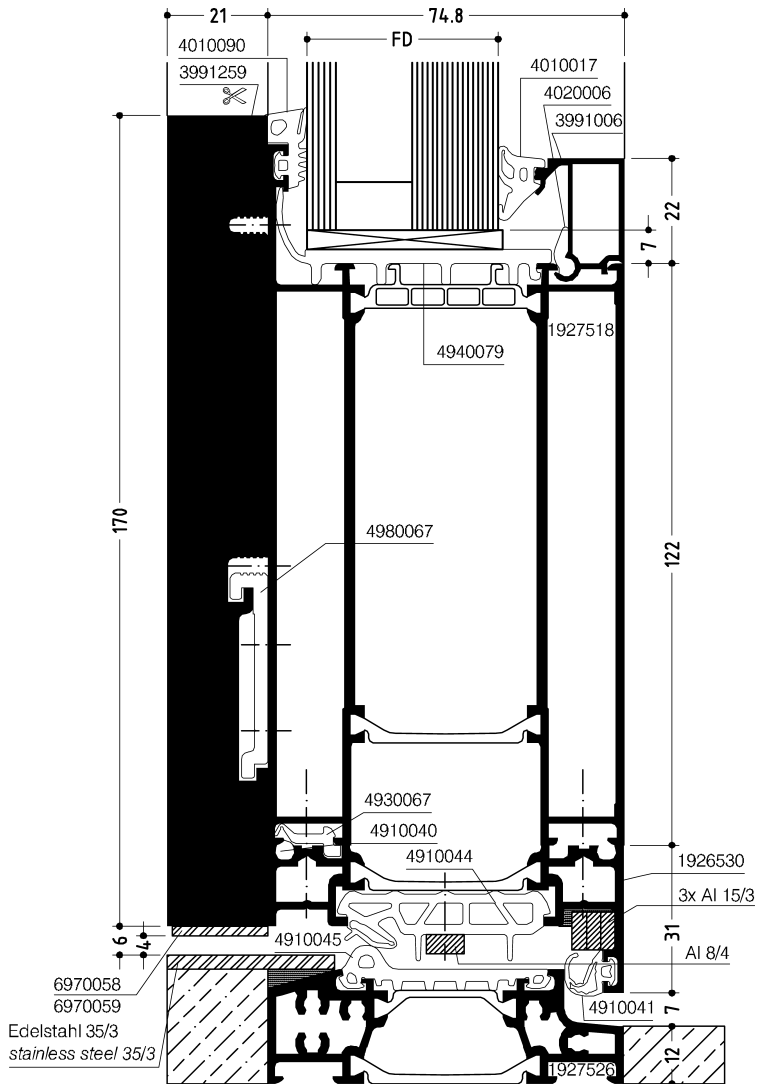

DOC-0000797964

Anschlagtüren
einwärts mit
Sockelprofil, Türso-
ckel

*Hinged doors
inwards with
bottom profile,
Bottom profile*

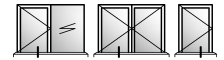
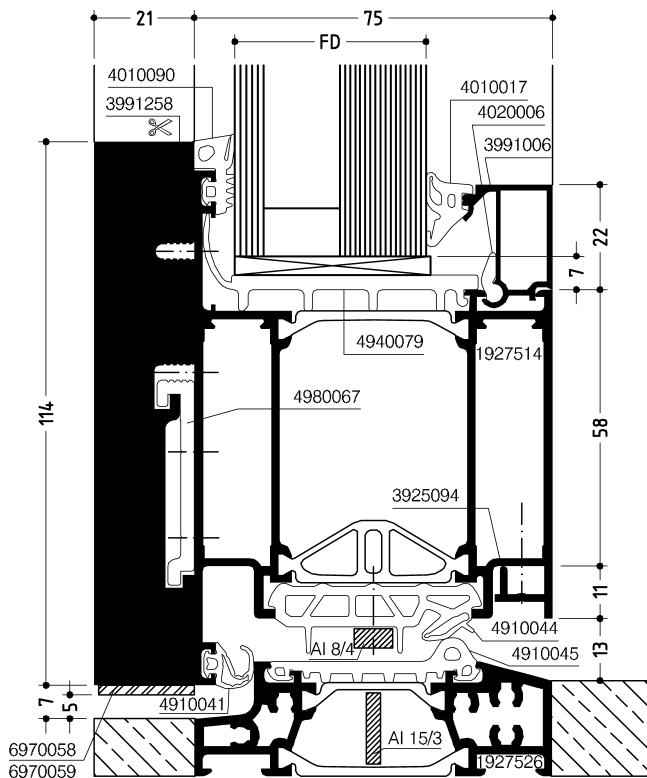

DOC-0000797730

Anschlagtüren
auswärts mit
Flügelprofil umlau-
fend, Türsockel

*Hinged doors
outwards with
circumferential leaf
profile, Bottom rail*

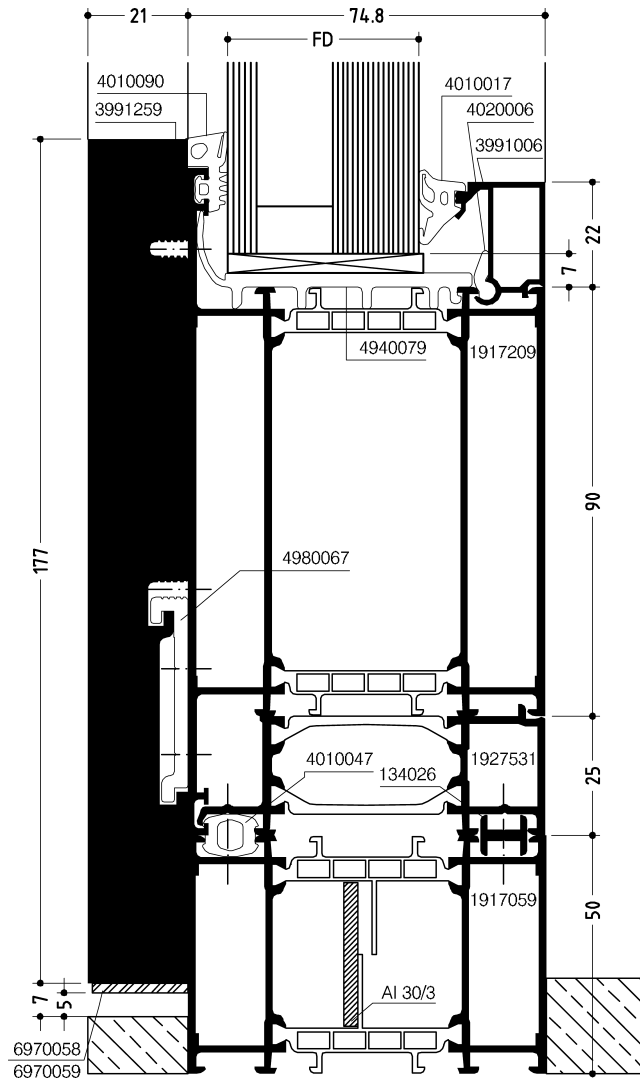

DOC-0000797876

Anschlagtüren
auswärts mit
Kämpferprofil, Fest-
feldsockel

*Hinged doors
outwards with
transom profile,
Fixed field bottom
rail*

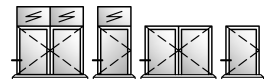
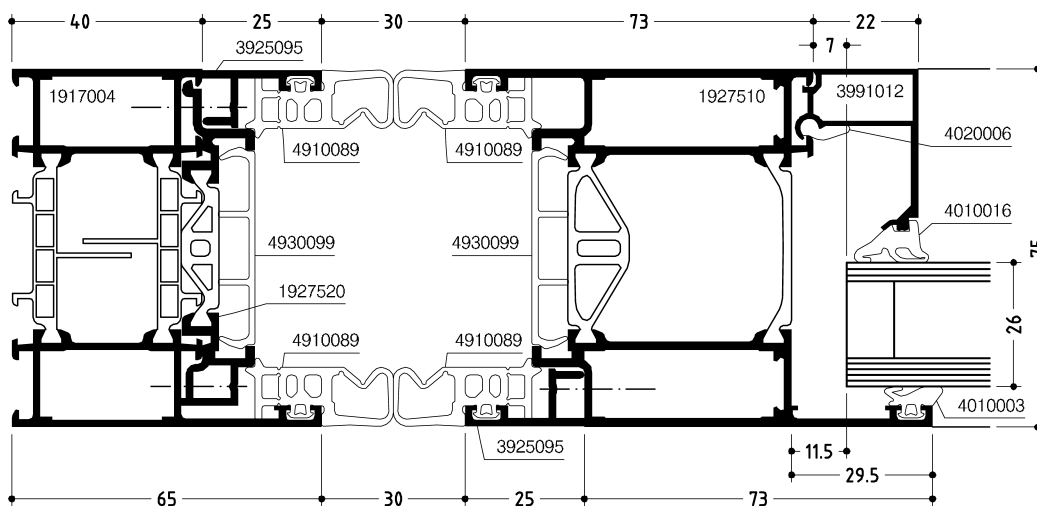

DOC-0000849791

Fingerschutztüren
einwärts mit Kombi-
nationsblendrah-
men

*Door with finger
protection gaskets
inwards with
combination
frame*

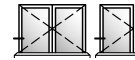
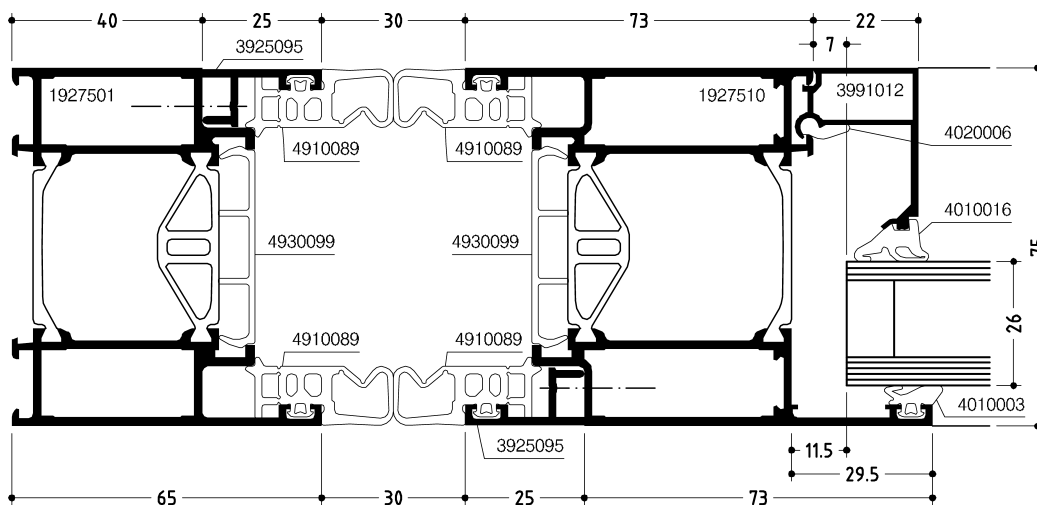

DOC-0000850546

Fingerschutztüren
einwärts mit Spezi-
alblendrahmen
*Door with finger
protection gaskets
inwards with
special frame*

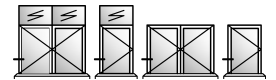
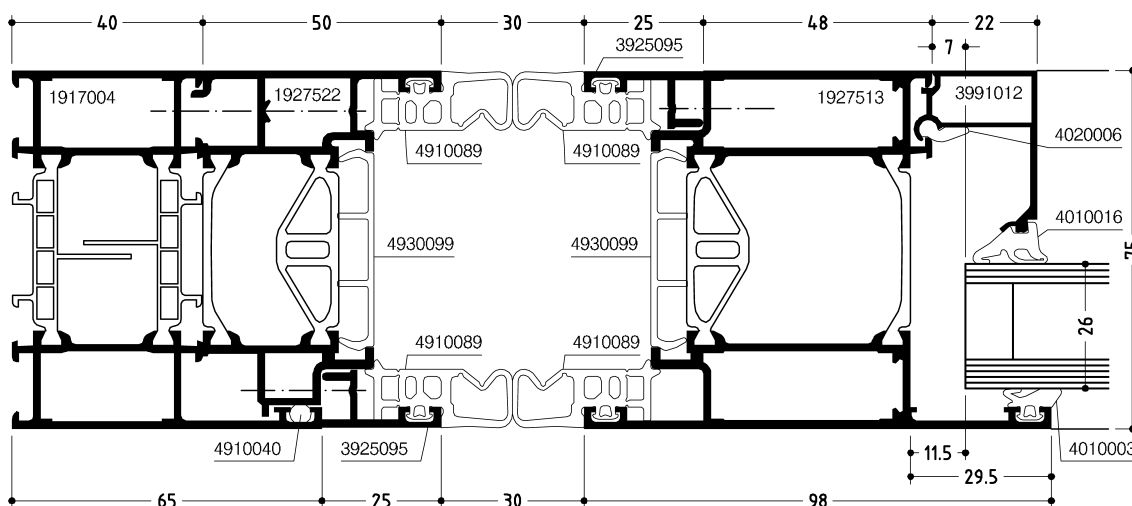

DOC-0000850548

Fingerschutztü-
ren auswärts mit
Kombinations-
blendrahmen
*Door with finger
protection gaskets
outwards with
combination
frame*

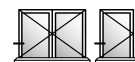
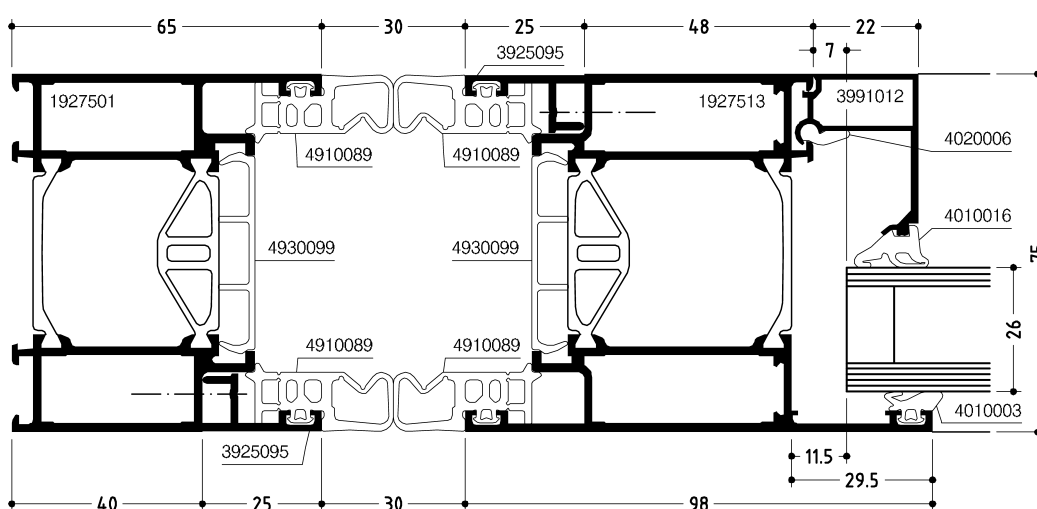

DOC-0000850477

Fingerschutztüren
auswärts mit Spezi-
alblendrahmen
*Door with finger
protection gaskets
outwards with
special frame*

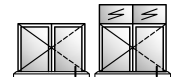
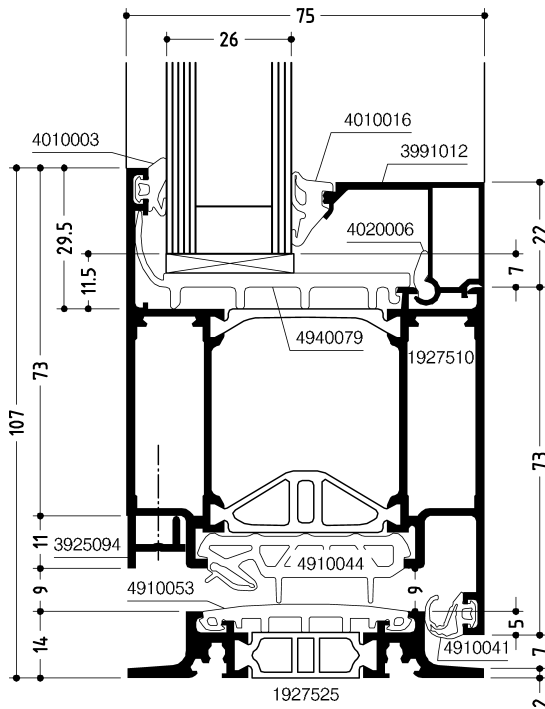

DOC-0000855790

Gegentaktüren
Flügel einwärts mit
Flügelprofil umlau-
fend

*Push-pull doors
leaf inwards with
circumferential leaf
profile*

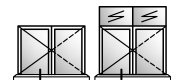
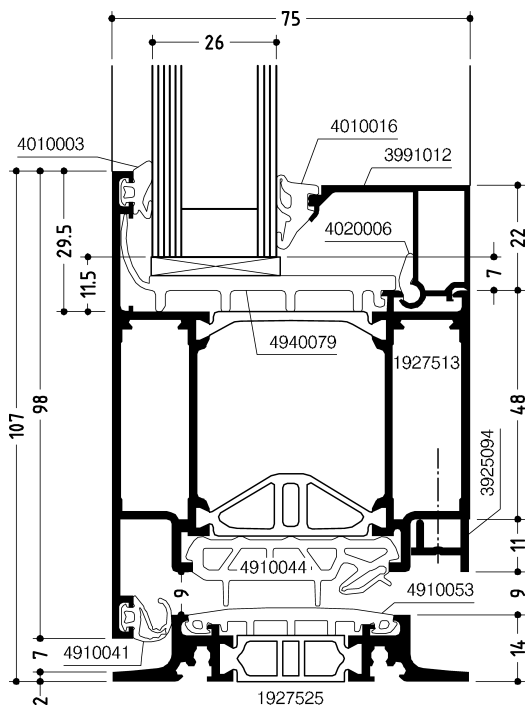

DOC-0000857615

Gegentaktüren
Flügel auswärts mit
Flügelprofil umlau-
fend

*Push-pull doors
leaf outwards with
circumferential leaf
profile*

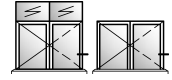
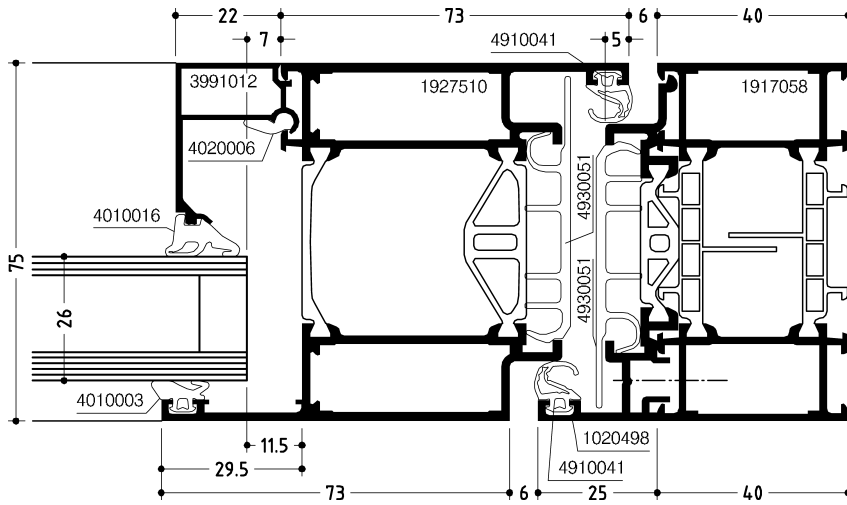

DOC-0000919915

Gegentaktüren
einwärts mit Neut-
ralblendrahmen
*Push-pull doors
inwards with neutral
frame profile*

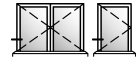
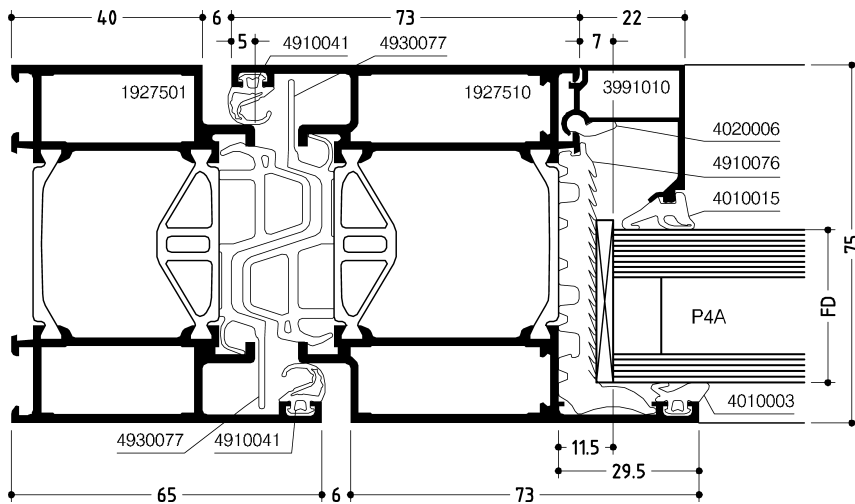

DOC-0000793667

Anschlagtüren
einwärts mit Spezi-
alblendrahmen,
Bandsicherung /
Füllungssicherung
*Hinged doors
inwards with
special frame,
Hinge sided
interlock / Infill
safeguard*

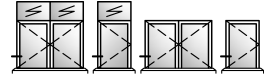
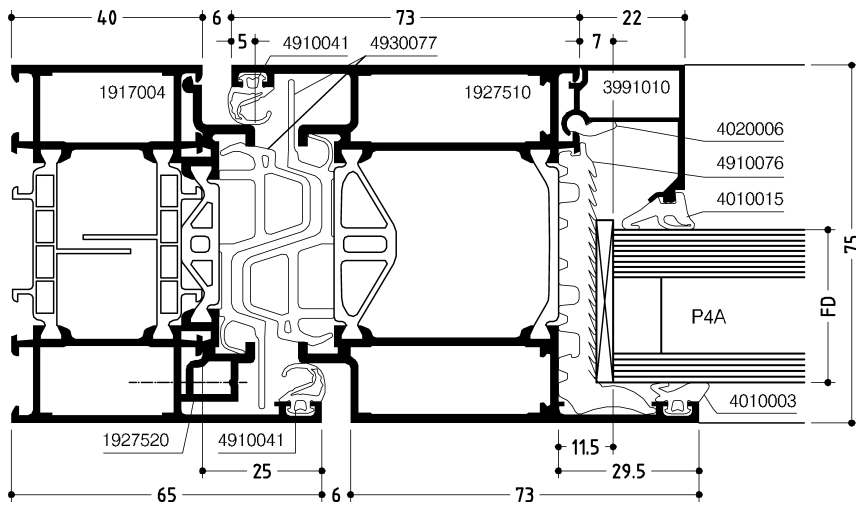

DOC-0000793782

Anschlagtüren
einwärts mit
Kombinations-
blendrahmen,
Bandsicherung /
Füllungssicherung

*Hinged doors
inwards with
combination
frame, Hinge sided
interlock / Infill
safeguard*

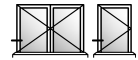
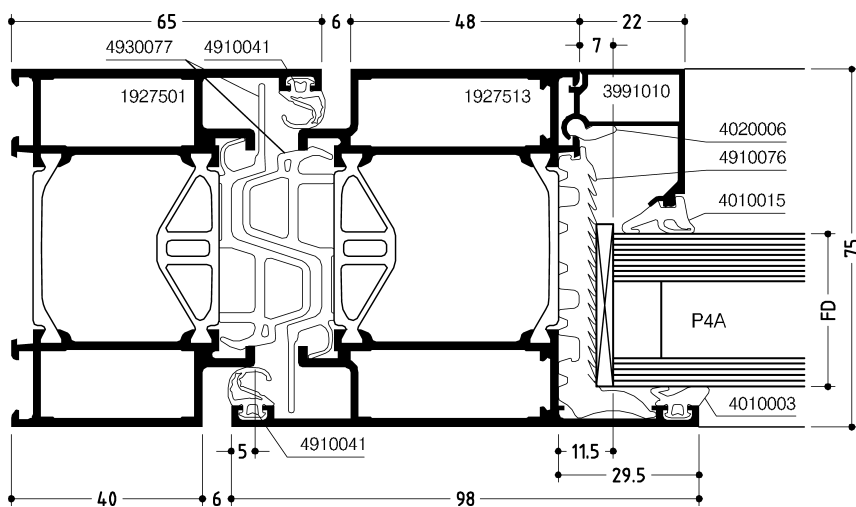

DOC-0000793837

Anschlagtüren
auswärts mit Spezi-
alblendrahmen,
Bandsicherung /
Füllungssicherung

*Hinged doors
outwards with
special frame,
Hinge interlock /
Infill safeguard*

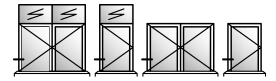
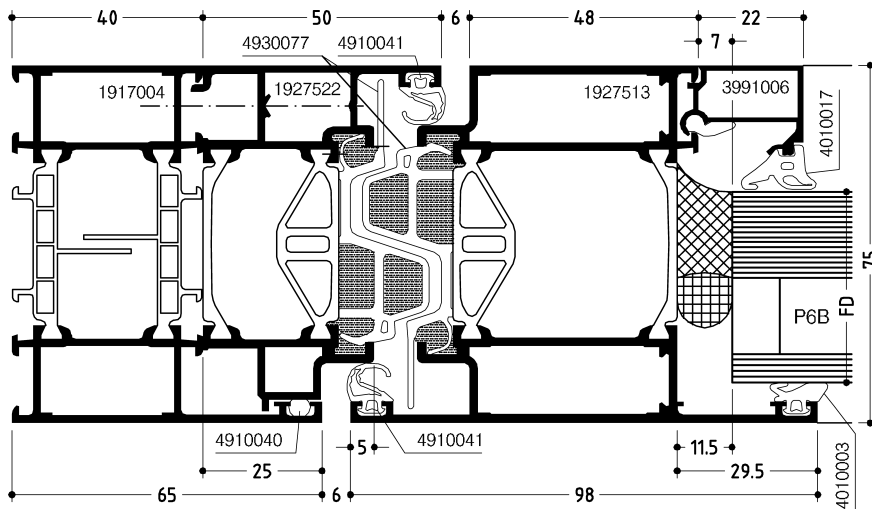

DOC-0000794032

Anschlagtüren
auswärts mit
Kombinations-
blendrahmen,
Bandsicherung /
Füllungssicherung

*Hinged doors
outwards with
combination
frame, Hinge sided
interlock / Infill
safeguard*

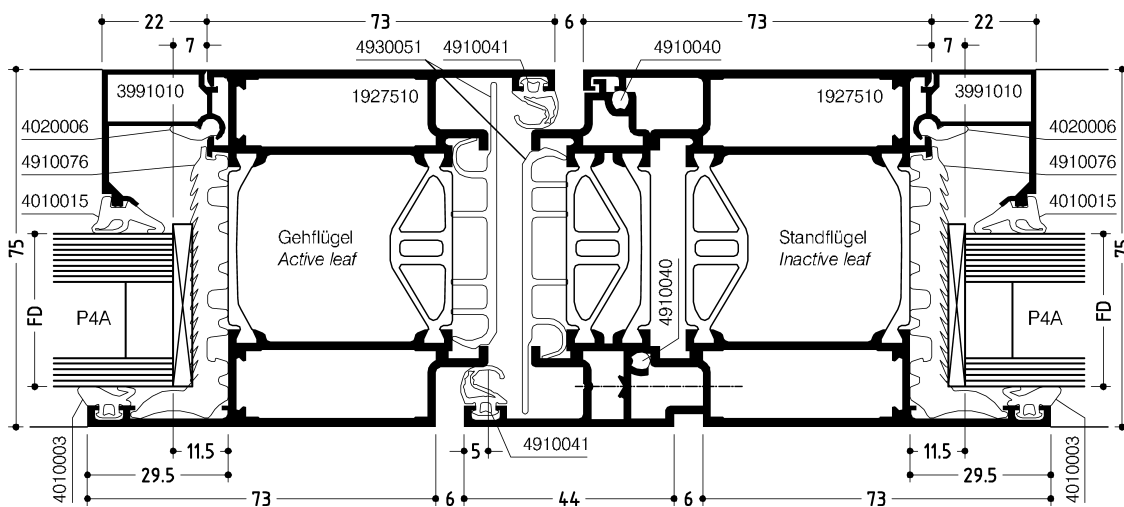

DOC-0000794540

Anschlagtüren
einwärts, Mittelstoß
mit Aufsatzprofil,
Türfalz / Füllungssi-
cherung

*Hinged doors
inwards, meeting
stiles with
supplementary
profile, Door rebate
/ Infill safeguard*

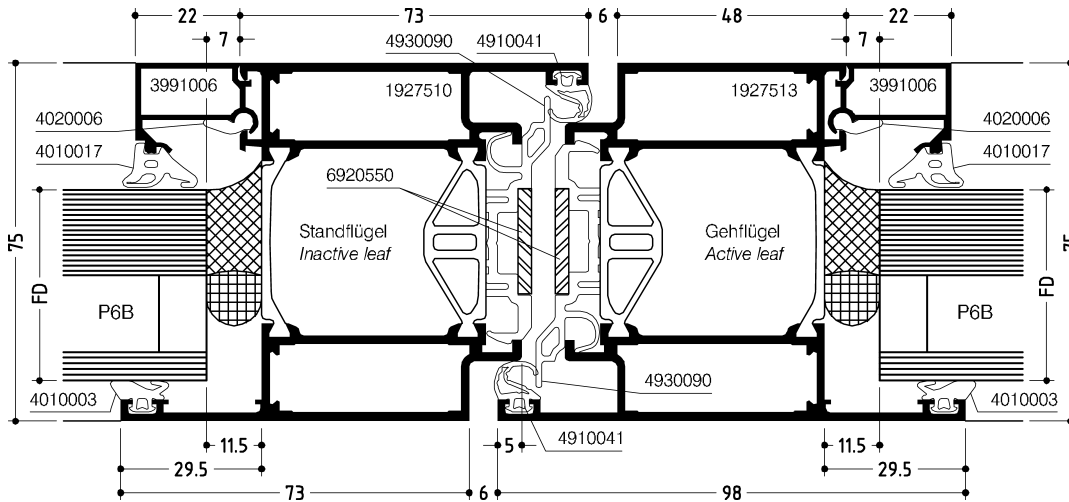

DOC-0000794445

Anschlagtüren
auswärts, Mittelstoß
mit Aufatzprofil,
Türfalz / Füllungssi-
cherung

*Hinged doors
outwards, meeting
stiles without
supplementary
profile, Door rebate
/ Infill safeguard*

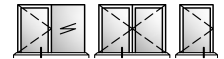
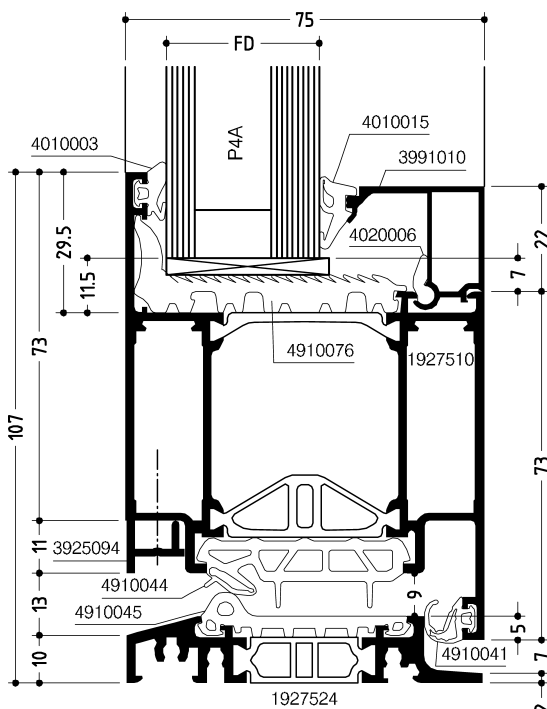

DOC-0000796217

Anschlagtüren
einwärts mit
Flügelprofil umlau-
fend, Türsockel /
Füllungssicherung

*Hinged doors
inwards with
circumferential leaf
profile, Bottom rail /
Infill safeguard*

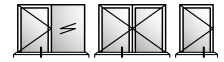
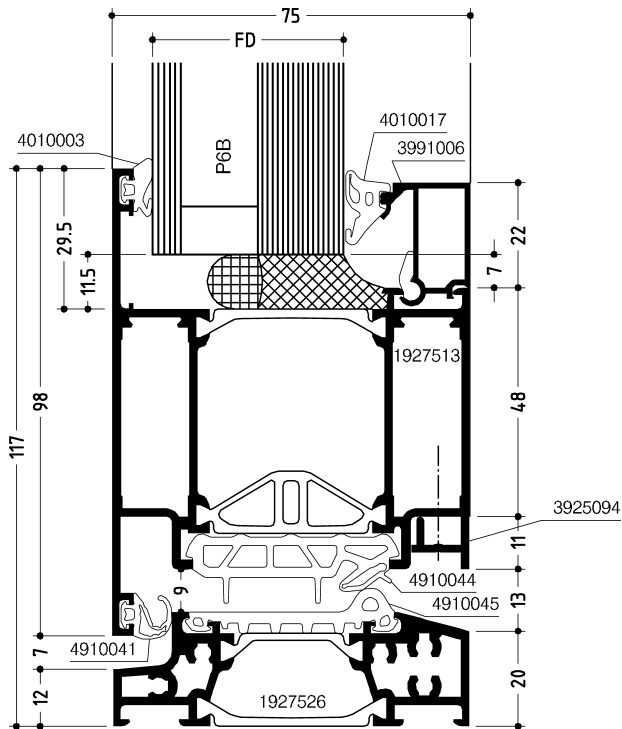

DOC-0000796480

Anschlagtüren
auswärts mit
Flügelprofil umlau-
fend, Türsockel /
Füllungssicherung

*Hinged doors
outwards with
circumferential leaf
profile, Bottom rail /
Infill safeguard*

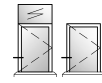
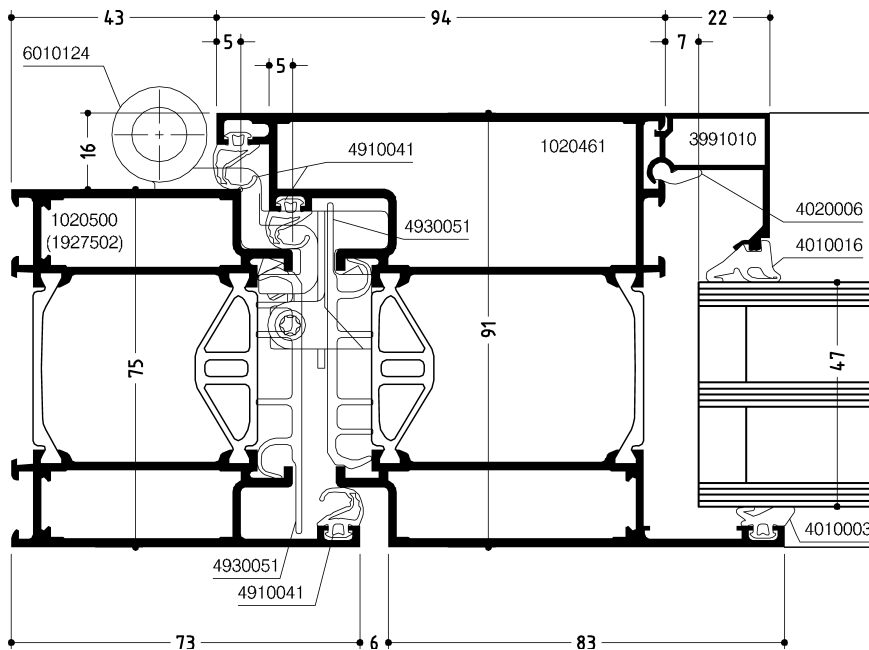

DOC-0001020636

Anschlagtüren
einwärts mit Spezi-
alblendrahmen
*Hinged doors
inwards with
special frame*

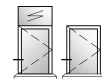
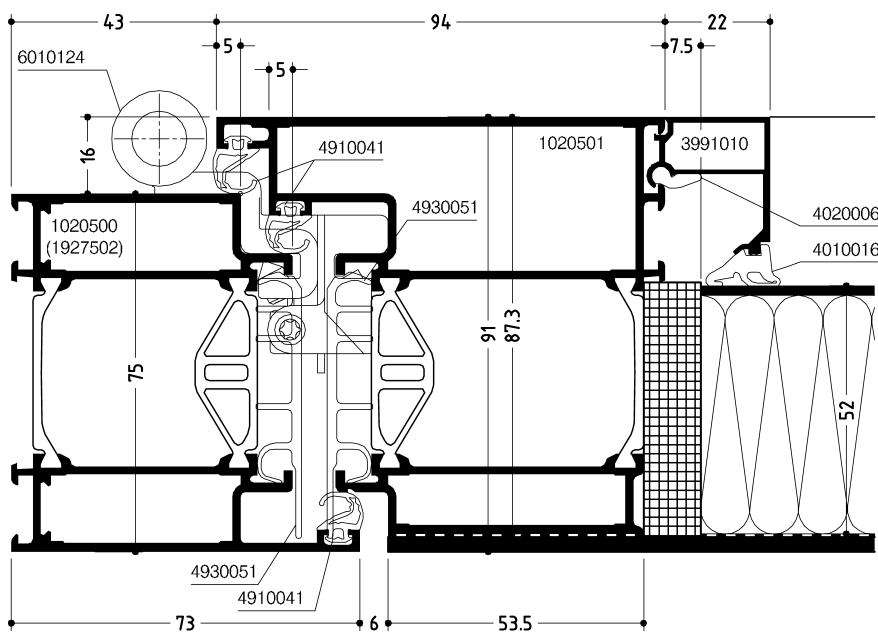

DOC-0001020648

Anschlagtüren
einwärts mit Spezi-
alblendrahmen.
Einseitig flügel-
überdeckende
Füllung
*Hinged doors
inwards with
special frame.
Single-sided leaf
overlapping infill*

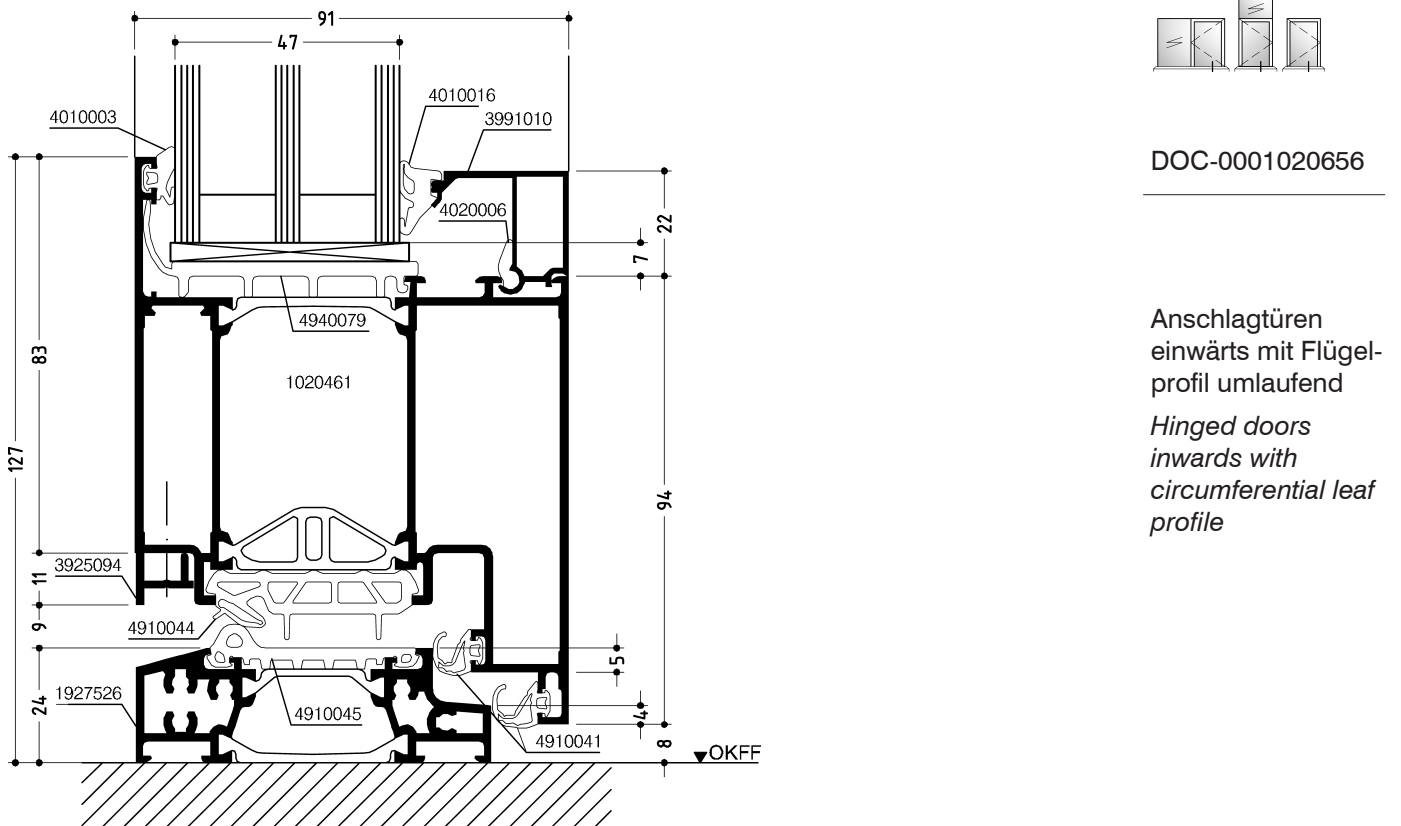
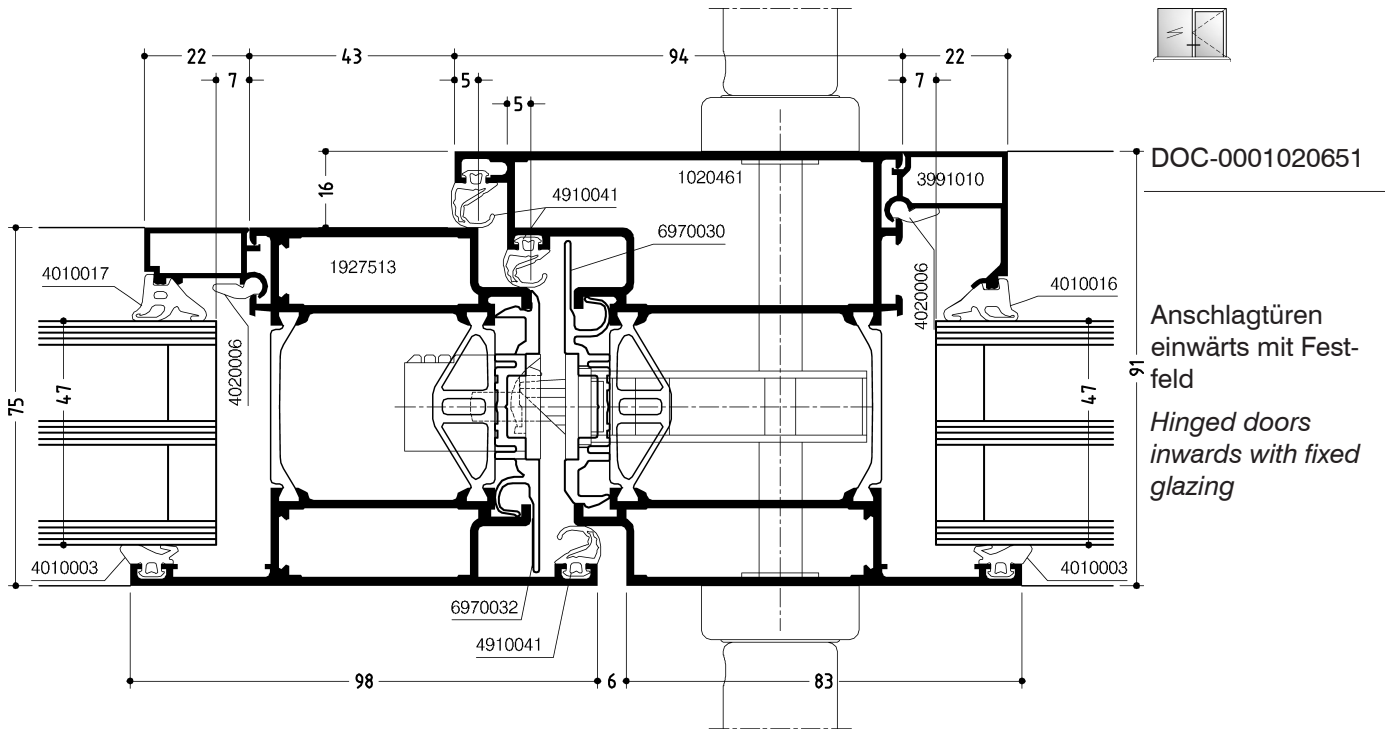

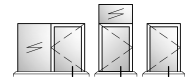
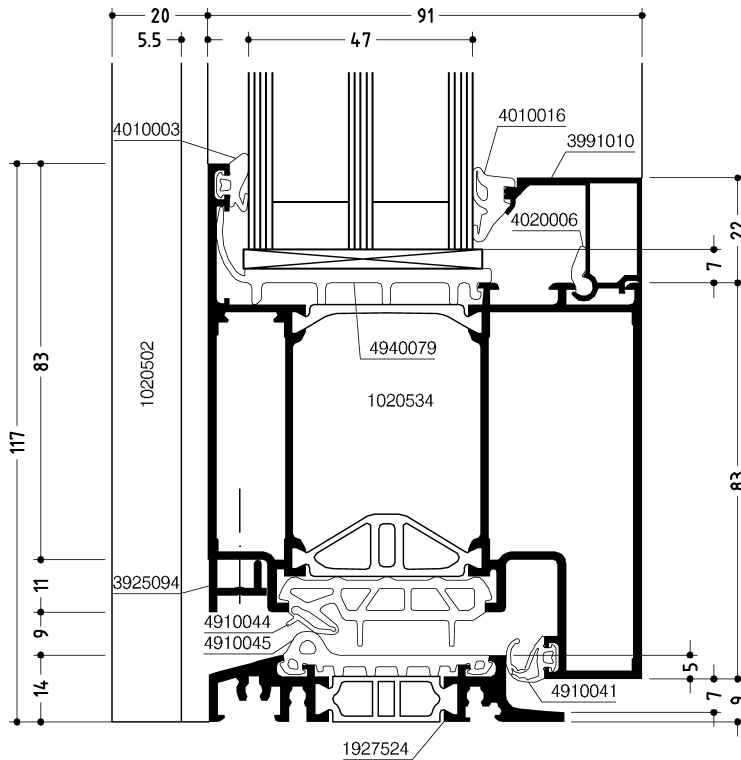

DOC-0001020683

Anschlagtüren
einwärts mit Sockel
Klassik Design 95
mm

*Hinged doors
inwards with
bottom rail profile
Classic Design 95
mm*

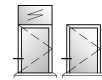
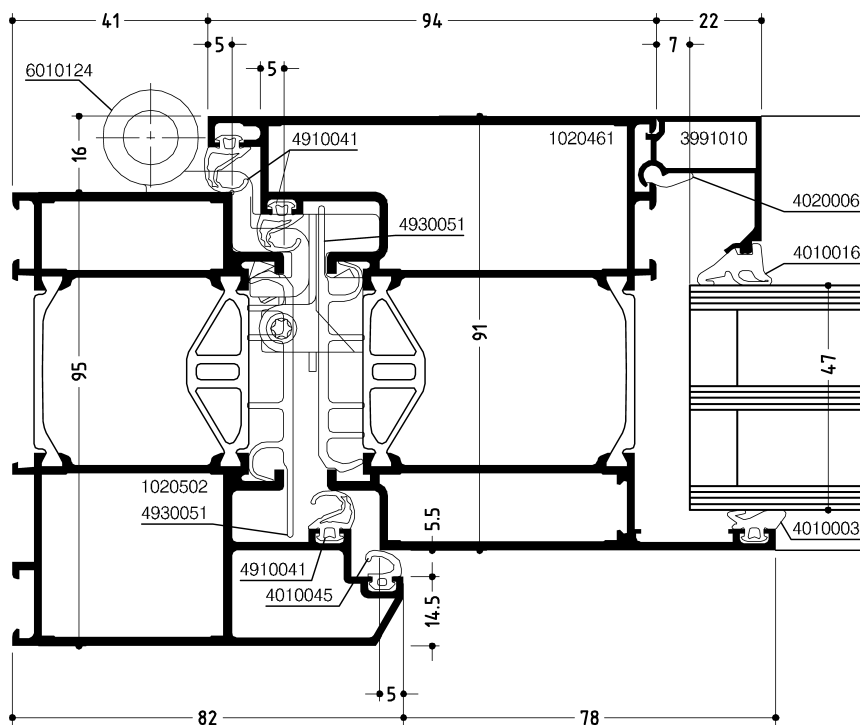

DOC-0001020669

Anschlagtüren
einwärts mit Spezi-
alblendrahmen
Klassik Design 95
mm

*Hinged doors
inwards with
special frame
Classic Design 95
mm*

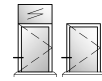
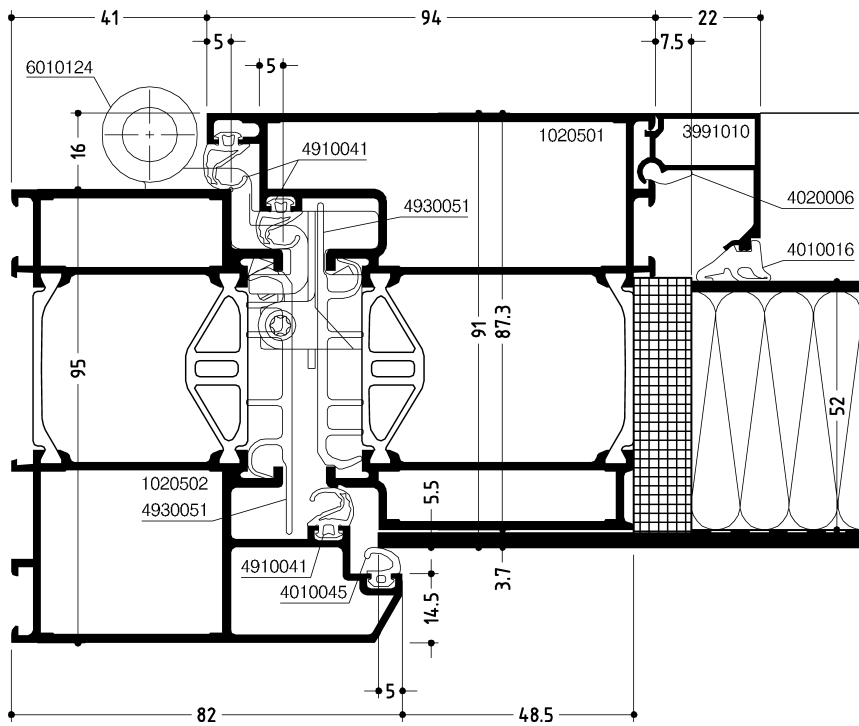

DOC-0001020672

Anschlagtüren
einwärts mit Spezi-
alblendrahmen
Klassik Design
95 mm, einseitig
flügelüberde-
ckende Füllung

*Hinged doors
inwards with
special frame
Classic Design 95
mm, single-sided
leaf overlapping
infill*

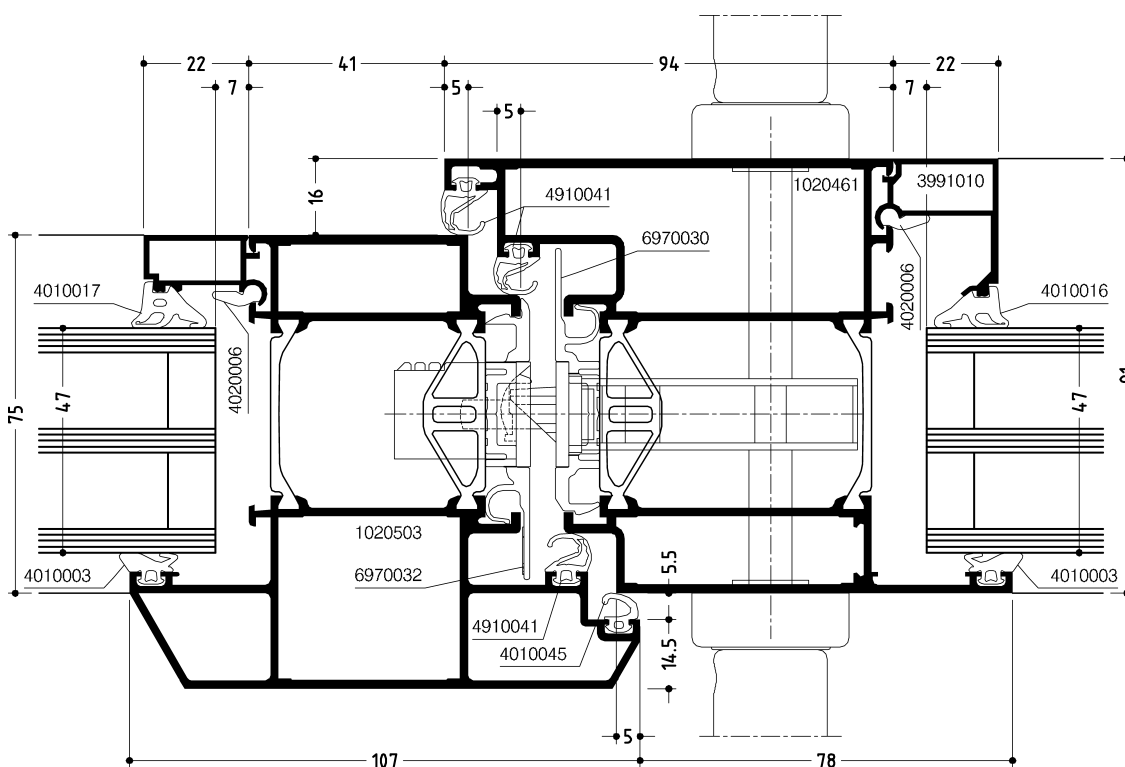

DOC-0001020675

Anschlagtüren
einwärts mit Fest-
feld Klassik Design
95 mm

*Hinged doors
inwards with fixed
glazing Classic
Design 95 mm*

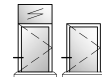
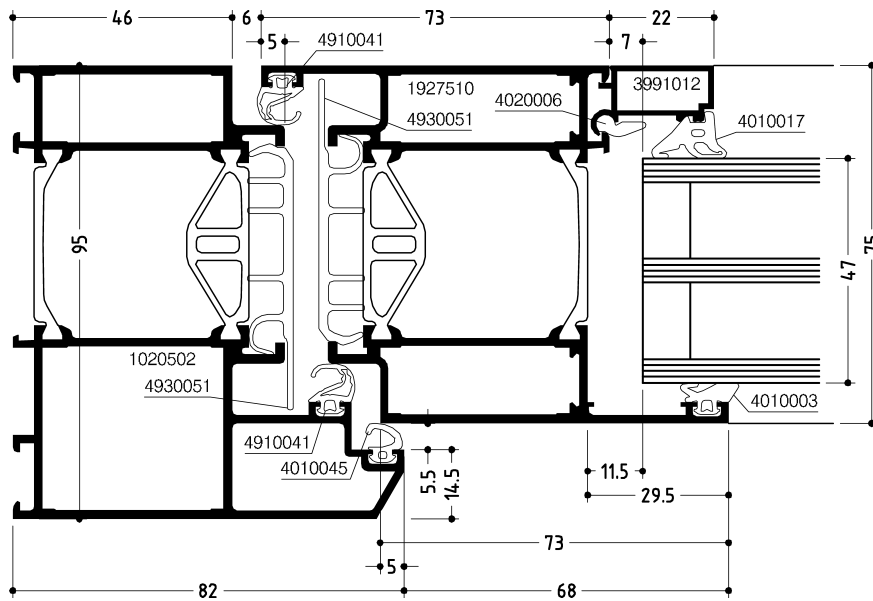

DOC-0001020687

Anschlagtüren
einwärts mit Spezi-
alblendrahmen
Klassik Design 95
mm

*Hinged doors
inwards with
special frame
Classic Design 90
mm*

WICSTYLE 75 evo

Glasleistenprofile, Auswahltabellen Glazing bead profiles, selection tables

Die Auswahltabelle zeigt die verschiedenen Glasleistenprofile und die zulässigen Füllungsdicken mit Toleranzen.

Die Auswahltabelle ist für Trockenverglasung mittels EPDM-Dichtungsprofilen ausgelegt.

Bei der Verglasung sind die Vorschriften der Glashersteller und der einschlägigen Fachverbände zu beachten, insbesondere die Forderung nach einem funktionssicheren Dampfdruckausgleich und Entwässerung der Hohlräume im Glasfalzraum zwischen Isolierglas-Scheibenkante und Falzgrund.

Die Auswahltabellen ermöglichen eine theoretische Vorplanung. Die Glastoleranzen sind zu berücksichtigen. Um extreme Toleranzen der Profile und Füllungsdicken ausgleichen zu können, ist es vorteilhaft, bei der Planung die Füllungsdicken aus den punktschraffierten Feldern der Auswahltabelle zu entnehmen.

Bei der Montage sind die Vorgaben praktisch zu prüfen und gegebenenfalls durch Variationen der Einrolldichtungen, dargestellt durch die schraffierten Felder, die notwendige Vorspannung aufzubringen.

In der Tabelle sind die Artikelnummern der schwarzen Dichtungen angegeben. Weitere Farben (z. B. grau), siehe Programm / Zubehör.

(XX) 4020006
Anwendung bei beschichteten Profilen
Use on coated profiles

4020049
Anwendung bei eloxierten Profilen
Use on anodized profiles

Beispiel / Example

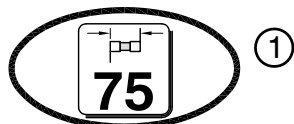

Glasleistenprofile Glazing bead profiles			a) Füllungsdicke ±1 mm mit Einrolldichtung Nr.: Infill thickness ±1 mm with rolled gasket no.:				
Nr. / No. 18 mm	Nr. / No. 22 mm	b) mm	4910004	4010015 blau / blue	4010016 rot / red	4010017 grün / green	4010018
3991022	3991001	2	60	59	58	57	56
3991023	3991002	5	57	56	55	54	53
3991024	3991003	9	53	52	51	50	49
3991025	3991004	12	50	49	48	47	46
3991026	3991005	15	47	46	45	44	43
3991027	3991006	19	43	42	41	40	39
3991028	3991007	22	40	39	38	37	36
3991029	3991008	24	38	37	36	35	34
3991030	3991009	26	36	35	34	33	32
3991031	3991010	29	33	32	31	30	29
3991032	3991011	32	30	29	28	27	26
3991033	3991012	34	28	27	26	25	24
3991034	3991013	37	25	24	23	22	21
3991035	3991014	41	21	20	19	18	17
3991036	3991015	45	17	16	15	14	13
3991037	3991016	49	13	12	11	10	9
3991037	3991017	52	10	9	8	7	6

- ① Bautiefe auswählen
Select construction depth
- ② Füllungsdicke auswählen
Select infill thickness
- ③ Entsprechende Glasleiste
Appropriate glazing bead
- ④ Entsprechende innere Verglasungsdichtung
Appropriate inner glazing gasket

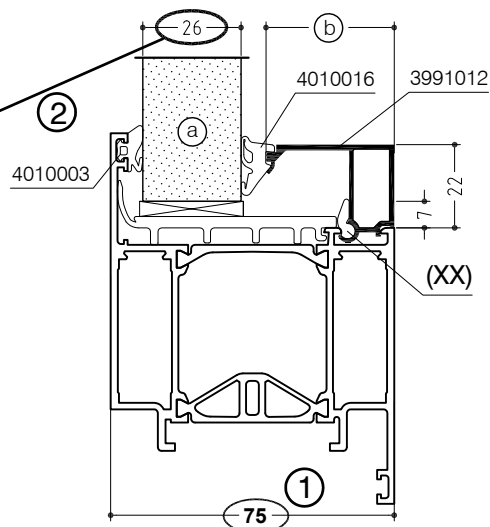

empfohlen
recommended

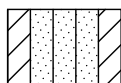

The selection table shows the different glazing bead profiles and the admissible infill thicknesses with tolerances.

The selection table is designed for dry glazing with EPDM glazing gaskets.

Please follow the glazing instructions of glass manufacturers and relevant professional associations, especially the demand for a functionally secure air pressure equalization and drainage of cavities in glazing rebate area between insulation glass pane edge and rebate base.

The selection tables enable a preliminary theoretical planning. The glass tolerances have to be considered while planning. It is recommended to select infill thicknesses from the dotted columns areas of the selection table in order to compensate for extreme tolerances of profiles and infill thicknesses.

Check the specifications practically and, if required, apply the correct gasket pressure by choosing the suitable roll-in gaskets listed in the hatched columns.

The gasket article numbers specified in the table are for black gaskets. For further colours (e. g. grey), please consult our Product range / Accessories.

WICSTYLE 75 evo

Glasleistenprofile, Auswahltabellen
 Glazing bead profiles, selection tables

Technische Information
 Technical Information



Glasleistenprofile Glazing bead profiles			a) Füllungsdicke ±1 mm mit Einrolldichtung Nr.: Infill thickness ±1 mm with rolled gasket no.:				
Nr. / No. 18 mm	Nr. / No. 22 mm	b) mm	4910004	4010015 blau / blue	4010016 rot / red	4010017 grün / green	4010018
	3991001	2	60	59	58	57	56
3991022	3991002	5	57	56	55	54	53
3991023	3991003	9	53	52	51	50	49
3991024	3991004	12	50	49	48	47	46
3991025	3991005	15	47	46	45	44	43
3991026	3991006	19	43	42	41	40	39
3991027	3991007	22	40	39	38	37	36
3991028	3991008	24	38	37	36	35	34
3991029	3991009	26	36	35	34	33	32
3991030	3991010	29	33	32	31	30	29
3991031	3991011	32	30	29	28	27	26
3991032	3991012	34	28	27	26	25	24
3991033	3991013	37	25	24	23	22	21
3991034	3991014	41	21	20	19	18	17
3991035	3991015	45	17	16	15	14	13
3991036	3991016	49	13	12	11	10	9
3991037	3991017	52	10	9	8	7	6

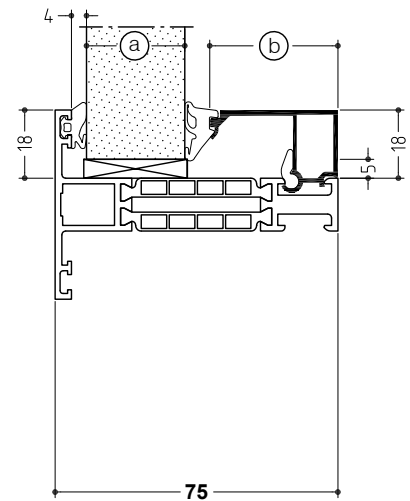
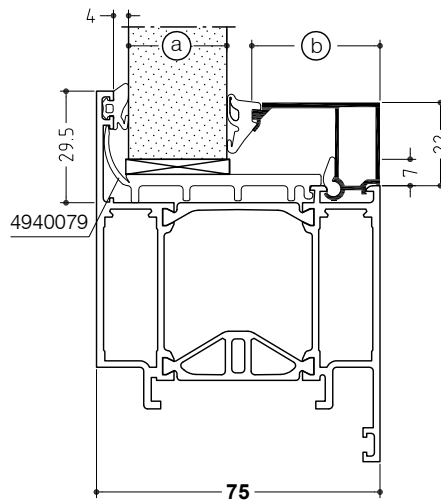
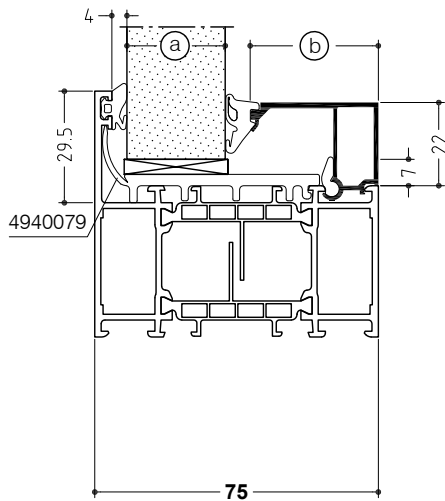

WICSTYLE 75 evo

Technische Information Technical Information

Glasleistenprofile, Auswahltabellen
Glazing bead profiles, selection tables



Glasleistenprofile Glazing bead profiles			(a) Füllungsdicke ±1 mm mit Einrolldichtung Nr.: Infill thickness ±1 mm with rolled gasket no.:				
Nr. / No. 18 mm	Nr. / No. 22 mm	(b) mm	4910004	4010015 blau / blue	4010016 rot / red	4010017 grün / green	4010018
	3991001	2	50	49	48	47	46
3991022	3991002	5	47	46	45	44	43
3991023	3991003	9	43	42	41	40	39
3991024	3991004	12	40	39	38	37	36
3991025	3991005	15	37	36	35	34	33
3991026	3991006	19	33	32	31	30	29
3991027	3991007	22	30	29	28	27	26
3991028	3991008	24	28	27	26	25	24
3991029	3991009	26	26	25	24	23	22
3991030	3991010	29	23	22	21	20	19
3991031	3991011	32	20	19	18	17	16
3991032	3991012	34	18	17	16	15	14
3991033	3991013	37	15	14	13	12	11
3991034	3991014	41	11	10	9	8	7
3991035	3991015	45	7	6	5	4	3

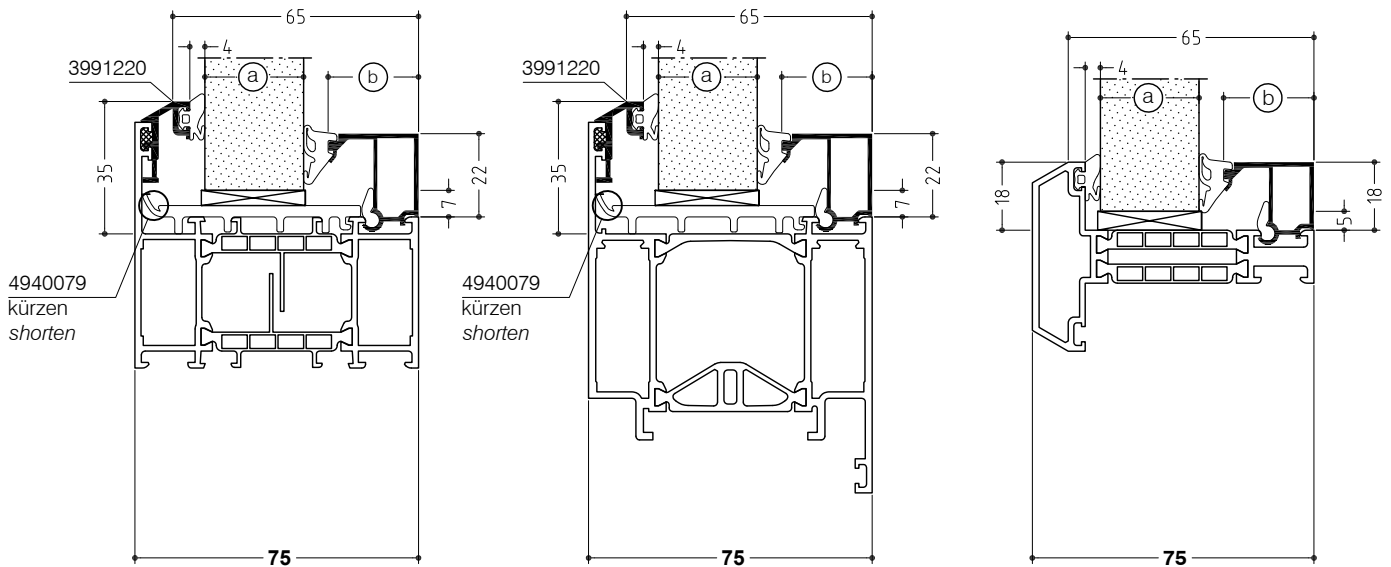



Türflügelprofile nach innen
Door leaf profiles inwards

Türflügelprofile nach außen
Door leaf profiles outwards

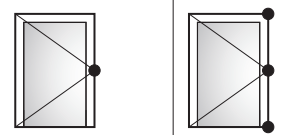
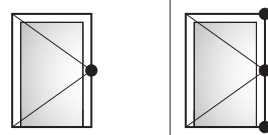
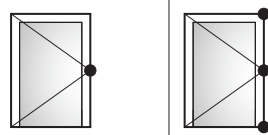
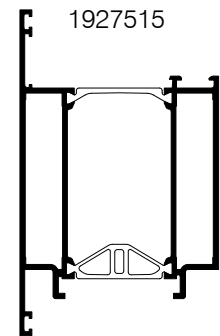
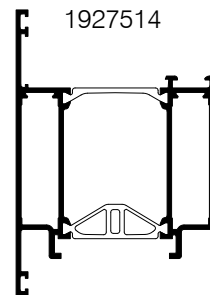
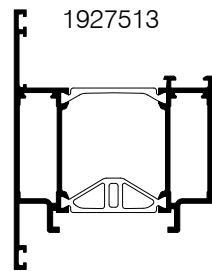
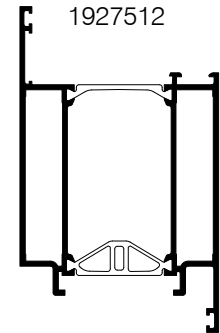
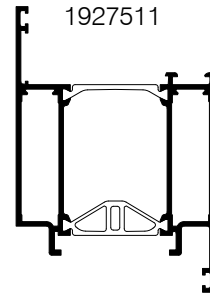
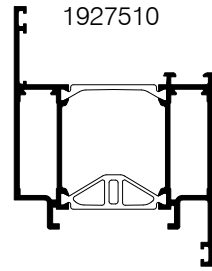

	(Pa)	800	400	800	800	400	800	800	400	800	
	(Pa)	150	150	150	150	150	150	150	150	150	
max.	FAB (m)	1.3	1.4	1.4	1.3	1.4	1.4	1.3	1.4	1.4	
	FAH (m)	2.35*	2.35*	2.52*	2.35*	2.35*	2.52*	2.35*	2.35*	2.52*	
min.	GF FAB (m)	0.6	0.6	0.6	0.6	0.6	0.6	0.6	0.6	0.6	
	SF FAB (m)	-	-	-	-	-	-	-	-	-	
	FAH (m)	-	-	-	-	-	-	-	-	-	
	min.	FAB (m)	0.6	0.6	0.6	0.6	0.6	0.6	0.6	0.6	
FAH (m)		2.01**	2.01**	2.01**	2.01**	2.01**	2.01**	2.01**	2.01**	2.01**	
	min.	FAB (m)	0.6	0.6	-	0.6	0.6	-	0.6	0.6	-
FAH (m)		2.01	2.01	-	2.01	2.01	-	2.01	2.01	-	
	max. (kg)	200			200			200			

* FAH > 2.2 m zusätzliches Mittelband erforderlich, RC1 N FAH_{max.} 2.1 m bei Einfallenverriegelung
* FAH > 2.2 m additional centre hinge required, RC1 N FAH_{max.} 2.1 m with single latch lockings

** RC1 N ohne Beschränkung FAH
** RC1 N without restriction FAH

WICSTYLE 75 evo

Fingerschutztüren
Finger protection doors

Zulässige Flügelgrößen
Admissible leaf sizes



Türflügelprofile nach innen
Door leaf profiles inwards

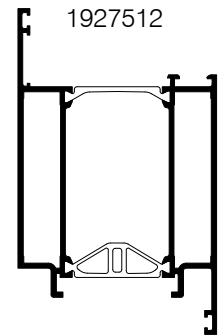
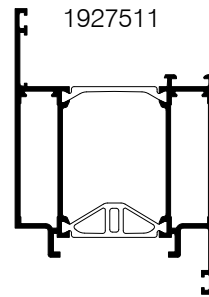
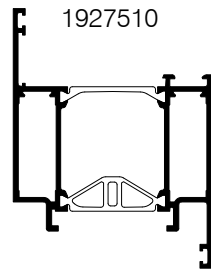

Türflügelprofile nach außen
Door leaf profiles outwards

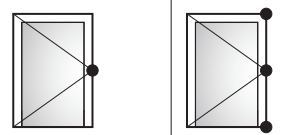
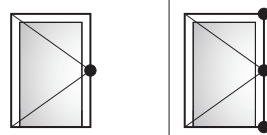
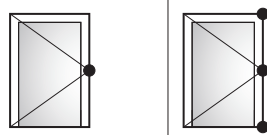
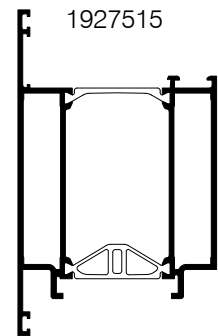
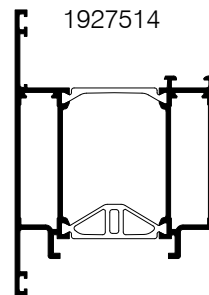
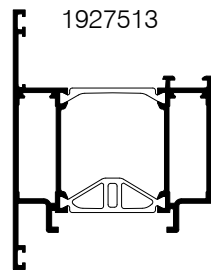

	(Pa)	800	400	800	800	400	800	800	400	800
	(Pa)	150	150	150	150	150	150	150	150	150
max.	FAB (m)	1.3	1.4	1.4	1.3	1.4	1.4	1.3	1.4	1.4
	FAH (m)	2.35*	2.35*	2.52*	2.35*	2.35*	2.52*	2.35*	2.35*	2.52*
min.	GF FAB (m)	0.6	0.6	0.6	0.6	0.6	0.6	0.6	0.6	0.6
	SF FAB (m)	-	-	-	-	-	-	-	-	-
	FAH (m)	-	-	-	-	-	-	-	-	-
	min.	FAB (m)	-	-	-	-	-	-	-	-
	min.	FAH (m)	-	-	-	-	-	-	-	-
	min.	FAB (m)	-	-	-	-	-	-	-	-
	min.	FAH (m)	-	-	-	-	-	-	-	-
	max. (kg)	200			200			200		

* FAH > 2.2 m zusätzliches Mittelband erforderlich

* FAH > 2.2 m additional centre hinge required

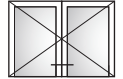

		1927513		1927514			1927515		
		1927510		1927511			1927512		
	(Pa)	400	800	400	400	800	400	400	800
	(Pa)	100	150	100	150	150	100	150	150
max.	FAB (m)	1.2	1.2	1.2	1.4	1.2	1.2	1.4	1.2
	FAH(m)	2.3*	2.52*	2.3*	2.52*	2.52*	2.3*	2.52*	2.52*
min.	GF FAB (m)	0.6	0.6	0.6	0.6	0.6	0.6	0.6	0.6
	SF FAB (m)	0.6	0.6	0.6	0.6	0.6	0.6	0.6	0.6
	FAH (m)	-	-	-	-	-	-	-	-
	min.	FAB (m)	0.6	0.6	0.6	0.6	0.6	0.6	0.6
	FAH (m)	2.01	2.01**	2.01	2.01**	2.01**	2.01	2.01**	2.01**
	min.	FAB (m)	0.6	-	0.6	-	-	0.6	-
	FAH (m)	2.01	-	2.01	-	-	2.01	-	-
	max.(kg)	200		200			200		

* FAH > 2.2 m zusätzliches Mittelband erforderlich, RC1 N FAH_{max.} 2.1 m bei Einfallenverriegelung
 * FAH > 2.2 m additional centre hinge required, RC1 N FAH_{max.} 2.1 m with single latch lockings

** RC1 N ohne Beschränkung FAH
 ** RC1 N without restriction FAH

WICSTYLE 75 evo

Fingerschutztüren
Finger protection doors

Zulässige Flügelgrößen
Admissible leaf sizes



		1927513		1927514		1927515	
		1927510		1927511		1927512	
	(Pa)	400	800	400	800	400	800
	(Pa)	100	150	100	150	100	150
max.	FAB (m)	1.2	1.2	1.2	1.2	1.2	1.2
	FAH(m)	2.3*	2.52*	2.3*	2.52*	2.3*	2.52*
min.	GF FAB (m)	0.6	0.6	0.6	0.6	0.6	0.6
	SF FAB (m)	0.6	0.6	0.6	0.6	0.6	0.6
	FAH (m)	-	-	-	-	-	-
	min. FAB (m)	-	-	-	-	-	-
	FAH (m)	-	-	-	-	-	-
	min. FAB (m)	-	-	-	-	-	-
	FAH (m)	-	-	-	-	-	-
	max.(kg)	200		200		200	

* FAH > 2.2 m zusätzliches Mittelband erforderlich

* FAH > 2.2 m additional centre hinge required

WICSTYLE 75 evo

Gegentakttüren
Push-pull doors

Zulässige Flügelgrößen
Admissible leaf sizes



		1927513		1927514		1927515	
		1927510		1927511		1927512	
	(Pa)	400	-	400	-	400	-
	(Pa)	-	-	-	-	-	-
max.	FAB (m)	1.2	-	1.2	-	1.2	-
	FAH(m)	2.3*	-	2.3*	-	2.3*	-
min.	GF FAB (m)	0.6	-	0.6	-	0.6	-
	SF FAB (m)	0.6	-	0.6	-	0.6	-
	FAH (m)	-	-	-	-	-	-
	min.	FAB (m)	-	-	-	-	-
		FAH (m)	-	-	-	-	-
	min.	FAB (m)	-	-	-	-	-
RC3		FAH (m)	-	-	-	-	-
	max.(kg)	200		200		200	

* FAH > 2.2 m zusätzliches Mittelband erforderlich

* FAH > 2.2 m additional centre hinge required

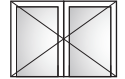

Türflügelprofile nach innen
Door leaf profiles inwards

Türflügelprofile nach außen
Door leaf profiles outwards

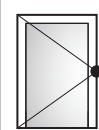
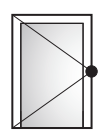
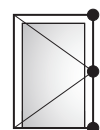
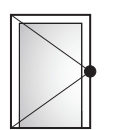
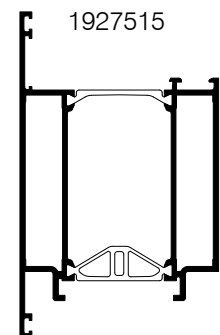
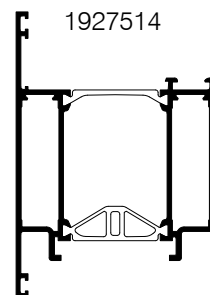
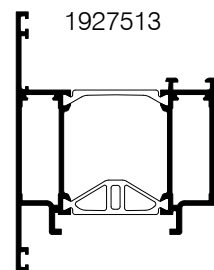
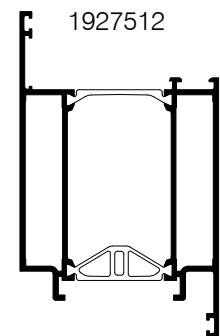
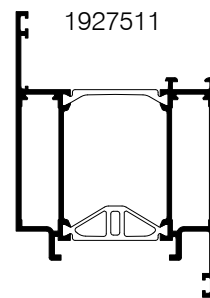
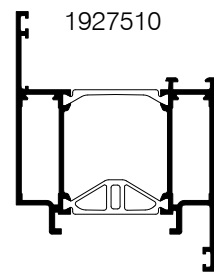
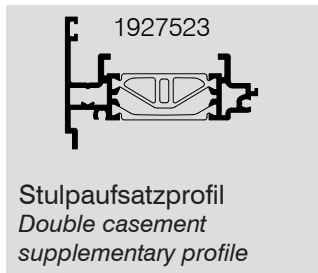

	(Pa)	400	800	400	400	800	400	400	800
	(Pa)	100	150	100	150	150	100	150	150
max.	FAB (m)	1.2	1.2	1.2	1.4	1.2	1.2	1.4	1.2
	FAH (m)	2.3*	2.52*	2.3*	2.52*	2.52*	2.3*	2.52*	2.52*
min.	GF FAB (m)	0.6	0.6	0.6	0.6	0.6	0.6	0.6	0.6
	SF FAB (m)	0.6	0.6	0.6	0.6	0.6	0.6	0.6	0.6
	FAH (m)	-	-	-	-	-	-	-	-
	min. FAB (m)	0.6	0.6	0.6	0.6	0.6	0.6	0.6	0.6
	FAH (m)	2.01	2.01**	2.01	2.01**	2.01**	2.01	2.01**	2.01**
	min. FAB (m)	0.6	-	0.6	-	-	0.6	-	-
	FAH (m)	2.01	-	2.01	-	-	2.01	-	-
	max. (kg)	200		200			200		

* FAH > 2.2 m zusätzliches Mittelband erforderlich

* FAH > 2.2 m additional centre hinge required

** RC1 N ohne Beschränkung FAH

** RC1 N without restriction FAH

WICSTYLE 75 evo

Fingerschutztüren
Finger protection doors

Zulässige Flügelgrößen
Admissible leaf sizes



Türflügelprofile nach innen
Door leaf profiles inwards

Türflügelprofile nach außen
Door leaf profiles outwards

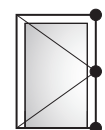
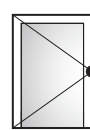
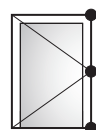
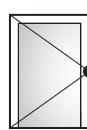
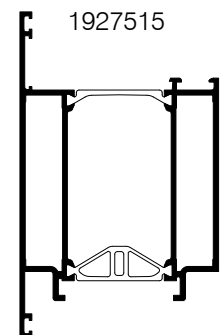
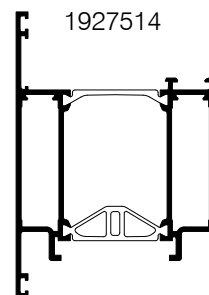
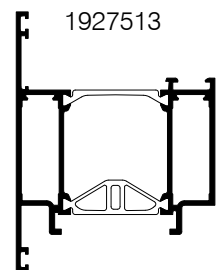
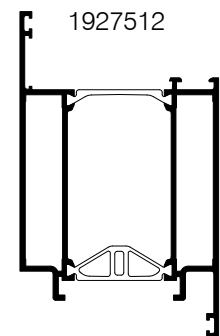
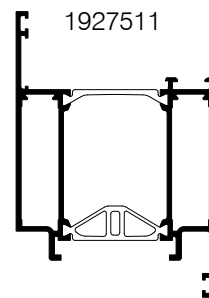
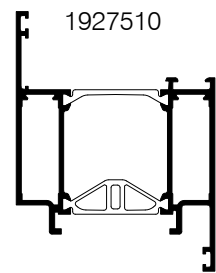
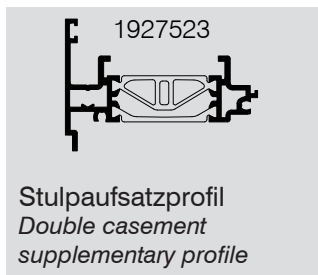

(Pa)		400	800	400	800	400	800
(Pa)		100	150	100	150	100	150
max.	FAB (m)	1.2	1.2	1.2	1.2	1.2	1.2
	FAH (m)	2.3*	2.52*	2.3*	2.52*	2.3*	2.52*
min.	GF FAB (m)	0.6	0.6	0.6	0.6	0.6	0.6
	SF FAB (m)	0.6	0.6	0.6	0.6	0.6	0.6
	FAH (m)	-	-	-	-	-	-
min.	FAB (m)	-	-	-	-	-	-
	FAH (m)	-	-	-	-	-	-
min.	FAB (m)	-	-	-	-	-	-
	FAH (m)	-	-	-	-	-	-
max. (kg)		200		200		200	

* FAH > 2.2 m zusätzliches Mittelband erforderlich

* FAH > 2.2 m additional centre hinge required

WICSTYLE 75 evo

Fluchttürverschlusssysteme
Escape door lock systems

Zulässige Flügelgrößen
Admissible leaf sizes



Türflügelprofile nach innen
Door leaf profiles inwards

Türflügelprofile nach außen
Door leaf profiles outwards

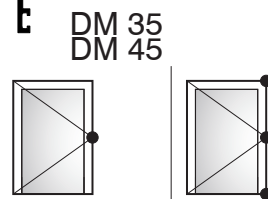
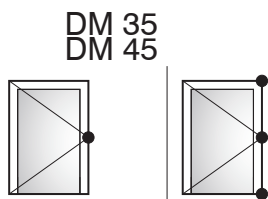
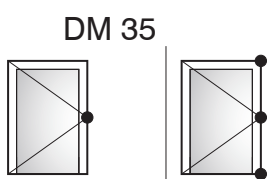
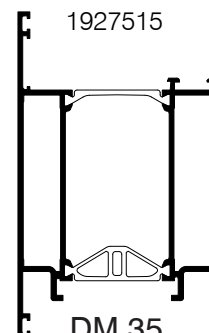
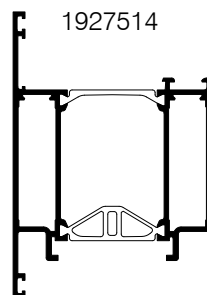
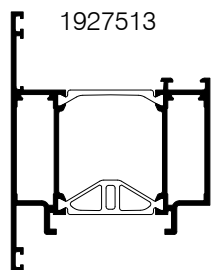
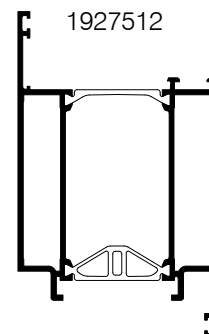
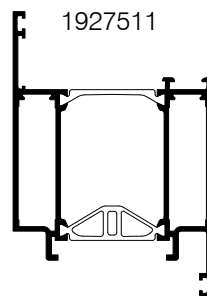
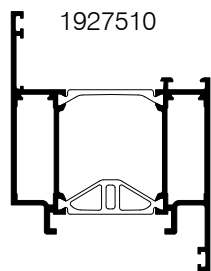

	(Pa)	800	400	800	800	400	800	800	400	800
	(Pa)	150	150	150	150	150	150	150	150	150
max.	FAB (m)	1.3	1.4	1.4	1.3	1.4	1.4	1.3	1.4	1.4
	FAH (m)	2.3*	2.3*	2.52*	2.3*	2.3*	2.52*	2.3*	2.3*	2.52*
min.	GF FAB (m)	0.91	0.91	0.91	0.91	0.91	0.91	0.91	0.91	0.91
	SF FAB (m)	-	-	-	-	-	-	-	-	-
	FAH (m)	-	-	-	-	-	-	-	-	-
	min.	FAB (m)	0.91	0.91	0.91	0.91	0.91	0.91	0.91	0.91
		FAH (m)	2.01**	2.01**	2.01**	2.01**	2.01**	2.01**	2.01**	2.01**
	min.	FAB (m)	-	-	-	-	-	-	-	-
		FAH (m)	-	-	-	-	-	-	-	-
	max. (kg)	200			200			200		

* FAH > 2.2 m zusätzliches Mittelband erforderlich, RC1 N FAH_{max.} 2.1 m bei Einfallenverriegelung

* FAH > 2.2 m additional centre hinge required, RC1 N FAH_{max.} 2.1 m with single latch lockings

** RC1 N ohne Beschränkung FAH

** RC1 N without restriction FAH

WICSTYLE 75 evo

Fluchttürverschlusssysteme
Escape door lock systems

Zulässige Flügelgrößen
Admissible leaf sizes



Türflügelprofile nach innen
Door leaf profiles inwards

Türflügelprofile nach außen
Door leaf profiles outwards

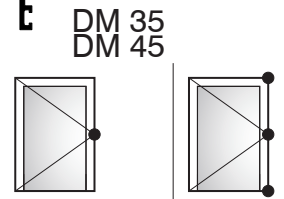
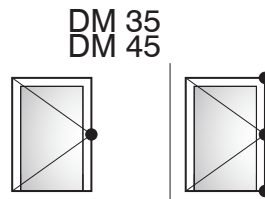
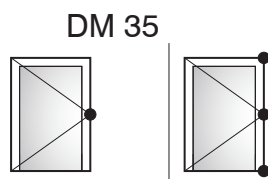
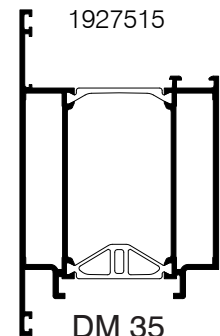
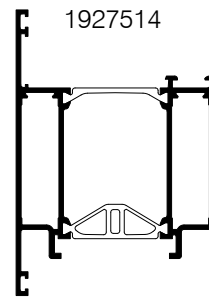
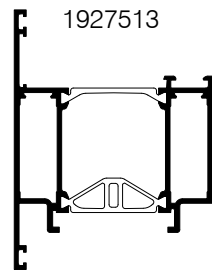
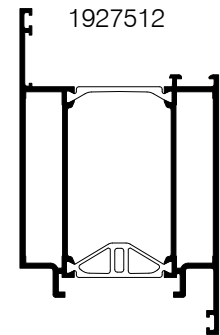
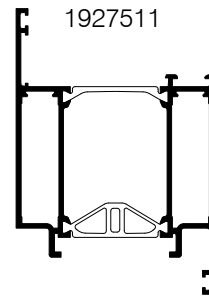
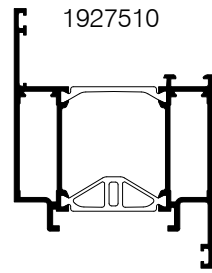

	(Pa)	800	400	800	800	400	800	800	400	800	
	(Pa)	150	150	150	150	150	150	150	150	150	
max.	FAB (m)	1.3	1.4	1.4	1.3	1.4	1.4	1.3	1.4	1.4	
	FAH (m)	2.3*	2.3*	2.52*	2.3*	2.3*	2.52*	2.3*	2.3*	2.52*	
min.	GF FAB (m)	0.91	0.91	0.91	0.91	0.91	0.91	0.91	0.91	0.91	
	SF FAB (m)	-	-	-	-	-	-	-	-	-	
	FAH (m)	-	-	-	-	-	-	-	-	-	
	min.	FAB (m)	0.91	0.91	0.91	0.91	0.91	0.91	0.91	0.91	
		FAH (m)	2.01**	2.01**	2.01**	2.01**	2.01**	2.01**	2.01**	2.01**	
	min.	FAB (m)	0.91	0.91	-	0.91	0.91	-	0.91	0.91	-
		FAH (m)	2.01	2.01	-	2.01	2.01	-	2.01	2.01	-
	max. (kg)	200			200			200			

* FAH > 2.2 m zusätzliches Mittelband erforderlich, RC1 N FAH_{max.} 2.1 m bei Einfallenverriegelung
* FAH > 2.2 m additional centre hinge required, RC1 N FAH_{max.} 2.1 m with single latch lockings

** RC1 N ohne Beschränkung FAH
** RC1 N without restriction FAH

WICSTYLE 75 evo

Fluchttürverschlusssysteme
Escape door lock systems

Zulässige Flügelgrößen
Admissible leaf sizes



		1927513		1927514			1927515		
		1927510		1927511			1927512		
		DM 35/35		DM 35/35 DM 45/45			DM 35/35 DM 45/45		
	(Pa)	400	800	400	400	800	400	400	800
	(Pa)	100	150	100	150	150	100	150	150
max.	FAB (m)	1.2	1.2	1.2	1.4	1.2	1.2	1.4	1.2
	FAH(m)	2.3*	2.52*	2.3*	2.52*	2.52*	2.3*	2.52*	2.52*
min.	GF FAB (m)	0.91	0.91	0.91	0.91	0.91	0.91	0.91	0.91
	SF FAB (m)	0.69	0.69	0.69	0.69	0.69	0.69	0.69	0.69
	FAH (m)	-	2.0	-	2.0	2.0	-	2.0	2.0
	min. GF FAB (m)	-	0.91	-	0.91	0.91	-	0.91	0.91
	FAH (m)	-	-	-	-	-	-	-	-
	min. GF FAB (m)	-	-	-	-	-	-	-	-
	FAH (m)	-	-	-	-	-	-	-	-
	max.(kg)	200		200			200		

* FAH > 2.2 m zusätzliches Mittelband erforderlich

* FAH > 2.2 m additional centre hinge required

WICSTYLE 75 evo

Fluchttürverschlusssysteme
Escape door lock systems

Zulässige Flügelgrößen
Admissible leaf sizes

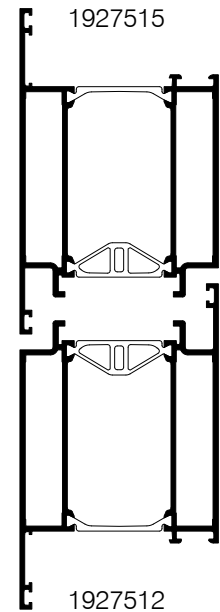
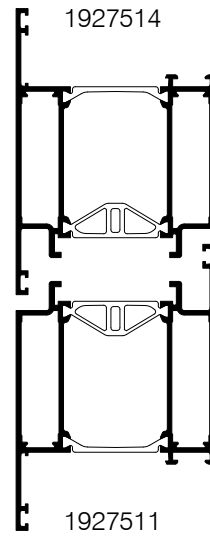
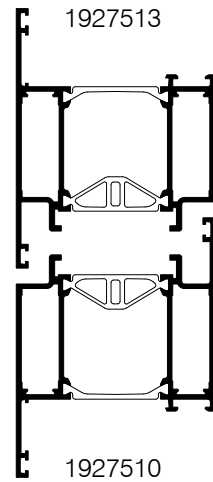
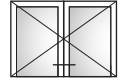

DM 35/35

DM 45/45

DM 45/45

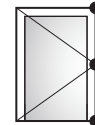
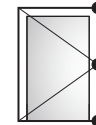
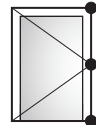
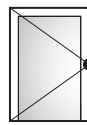

	(Pa)	400	800	400	400	800	400	400	800
	(Pa)	100	150	100	150	150	100	150	150
max.	FAB (m)	1.2	1.2	1.2	1.4	1.2	1.2	1.4	1.2
	FAH(m)	2.3*	2.52*	2.3*	2.52*	2.52*	2.3*	2.52*	2.52*
min.	GF FAB (m)	0.91	0.91	0.91	0.91	0.91	0.91	0.91	0.91
	SF FAB (m)	0.69	0.69	0.69	0.69	0.69	0.69	0.69	0.69
	FAH (m)	-	2.0	-	2.0	2.0	-	2.0	2.0
	min.	GF FAB (m)	0.91**	0.91**	0.91**	0.91**	0.91**	0.91**	0.91**
		FAH (m)	2.01**	2.01**	2.01**	2.01**	2.01**	2.01**	2.01**
	min.	GF FAB (m)	0.91	-	0.91	-	-	0.91	-
		FAH (m)	2.01***	-	2.01***	-	-	2.01***	-
	max.(kg)	200		200			200		

* FAH > 2.2 m zusätzliches Mittelband erforderlich

* FAH > 2.2 m additional centre hinge required

** RC1 N ohne Beschränkung FAH

** RC1 N without restriction FAH

*** RC3 nur Teilpanik

*** RC3 partial panic!



DM 35/35
Ausführung nur mit Druckstange möglich
Only version with touch-bar possible

WICSTYLE 75 evo

Fluchttürverschlusssysteme
Escape door lock systems

Zulässige Flügelgrößen
Admissible leaf sizes

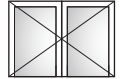

Türflügelprofile nach innen
Door leaf profiles inwards

Türflügelprofile nach außen
Door leaf profiles outwards

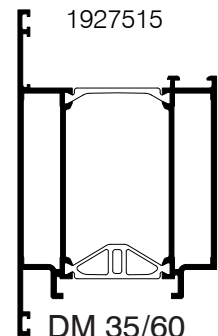
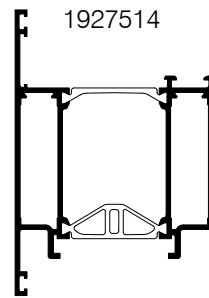
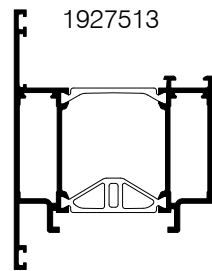
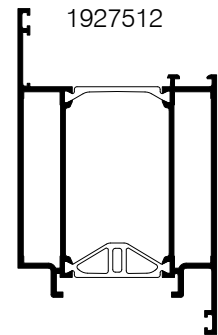
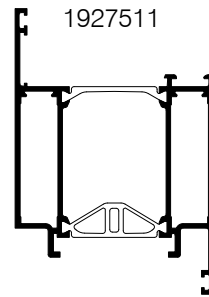
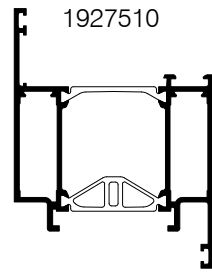
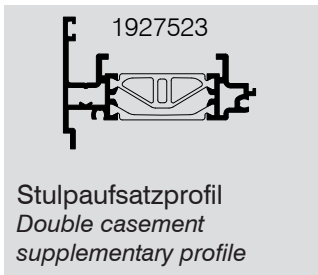

DM 35/60

DM 35/60
DM 45/70

DM 35/60
DM 45/70

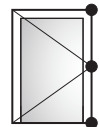
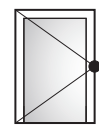
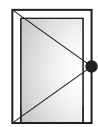
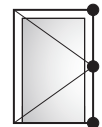
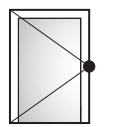

	(Pa)	400	800	400	400	800	400	400	800
	(Pa)	100	150	100	150	150	100	150	150
max.	FAB (m)	1.2	1.2	1.2	1.4	1.2	1.2	1.4	1.2
	FAH (m)	2.3*	2.52*	2.3*	2.52*	2.52*	2.3*	2.52*	2.52*
min.	GF FAB (m)	0.91	0.91	0.91	0.91	0.91	0.91	0.91	0.91
	SF FAB (m)	0.69	0.69	0.69	0.69	0.69	0.69	0.69	0.69
	FAH (m)	-	2.0	-	2.0	2.0	-	2.0	2.0
min.	GF FAB (m)	-	0.91	-	0.91	0.91	-	0.91	0.91
	FAH (m)	-	-	-	-	-	-	-	-
RC3 min.	GF FAB (m)	-	-	-	-	-	-	-	-
	FAH (m)	-	-	-	-	-	-	-	-
max.	max. (kg)	200		200			200		

* FAH > 2.2 m zusätzliches Mittelband erforderlich

* FAH > 2.2 m additional centre hinge required

WICSTYLE 75 evo

Fluchttürverschlusssysteme
Escape door lock systems

Zulässige Flügelgrößen
Admissible leaf sizes

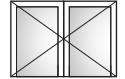

Türflügelprofile nach innen
Door leaf profiles inwards

Türflügelprofile nach außen
Door leaf profiles outwards

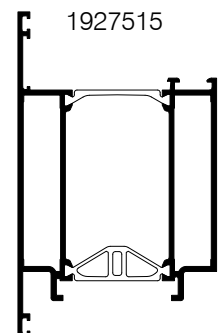
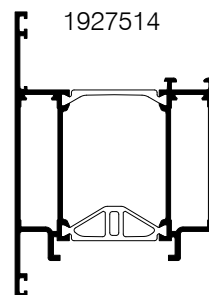
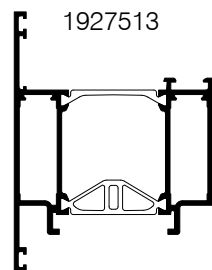
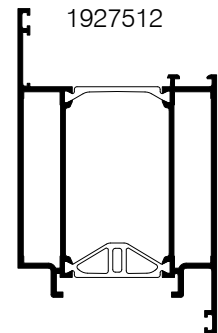
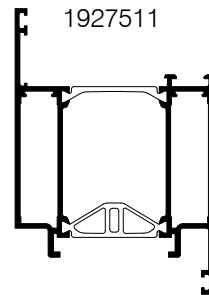
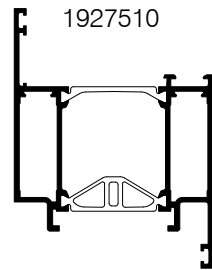
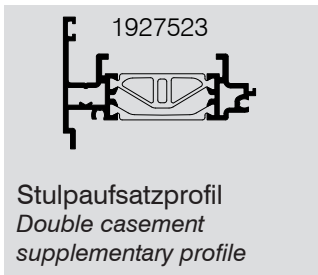

DM 35/60

DM 45/70

DM 45/70

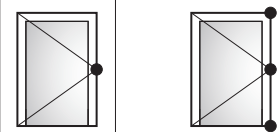
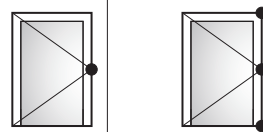
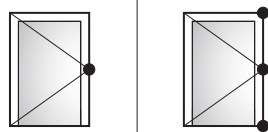

	(Pa)	400	800	400	400	800	400	400	800
	(Pa)	100	150	100	150	150	100	150	150
max.	FAB (m)	1.2	1.2	1.2	1.4	1.2	1.2	1.4	1.2
	FAH (m)	2.3*	2.52*	2.3*	2.52*	2.52*	2.3*	2.52*	2.52*
min.	GF FAB (m)	0.91	0.91	0.91	0.91	0.91	0.91	0.91	0.91
	SF FAB (m)	0.69	0.69	0.69	0.69	0.69	0.69	0.69	0.69
	FAH (m)	-	2.0	-	2.0	2.0	-	2.0	2.0
	min.	GF FAB (m)	0.91**	0.91**	0.91**	0.91**	0.91**	0.91**	0.91**
		FAH (m)	2.01**	2.01**	2.01**	2.01**	2.01**	2.01**	2.01**
	min.	GF FAB (m)	0.91	-	0.91	-	-	0.91	-
		FAH (m)	2.01***	-	2.01***	-	-	2.01***	-
	max. (kg)	200		200			200		

* FAH > 2.2 m zusätzliches Mittelband erforderlich

* FAH > 2.2 m additional centre hinge required

** RC1 N ohne Beschränkung FAH

** RC1 N without restriction FAH

*** RC3 nur Teilpanik

*** RC3 partial panic!



DM 35/60
Ausführung nur mit Druckstange möglich
Only version with touch-bar possible

WICSTYLE 75 evo

Türen mit flügelüberdeckender Füllung
Doors with leaf overlapping infill

Zulässige Flügelgrößen
Admissible leaf sizes







		1920517			1920513			1320033		
	(Pa)	800	400	800	800	400	800	800	400	800
	(Pa)	150	150	150	150	150	150	150	150	150
max.	FAB (m)	1.3	1.4	1.4	1.3	1.4	1.4	1.3	1.4	1.4
	FAH (m)	2.1	2.1	2.1	2.1	2.1	2.1	2.1	2.1	2.1
min.	GF FAB (m)	0.6	0.6	0.6	0.6	0.6	0.6	0.6	0.6	0.6
	SF FAB (m)	-	-	-	-	-	-	-	-	-
	FAH (m)	-	-	-	-	-	-	-	-	-
	min.	FAB (m)	-	-	-	-	-	-	-	-
		FAH (m)	-	-	-	-	-	-	-	-
	min.	FAB (m)	-	-	-	-	-	-	-	-
RC3		FAH (m)	-	-	-	-	-	-	-	-
	max.(kg)	200			200			200		

WICSTYLE 75 evo

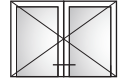
Türen mit flügelüberdeckender Füllung
Doors with leaf overlapping infill

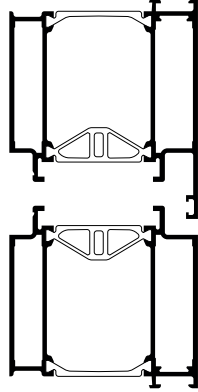
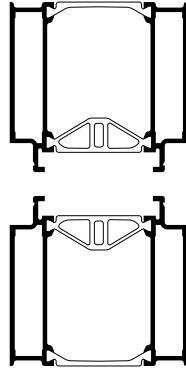
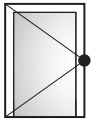
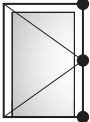
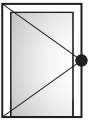
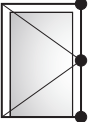
Zulässige Flügelgrößen
Admissible leaf sizes



		1920517		1920513			
							
		1320033		1920513			
		 		 			
	(Pa)	400	800	400	800	-	-
	(Pa)	100	150	100	150	-	-
max.	FAB (m)	1.2	1.2	1.2	1.2	-	-
	FAH (m)	2.1	2.1	2.1	2.1	-	-
min.	GF FAB (m)	0.6	0.6	0.6	0.6	-	-
	SF FAB (m)	0.6	0.6	0.6	0.6	-	-
	FAH (m)	-	-	-	-	-	-
	min.	FAB (m)	-	-	-	-	-
	FAH (m)	-	-	-	-	-	-
	min.	FAB (m)	-	-	-	-	-
	FAH (m)	-	-	-	-	-	-
	max.(kg)	200		200		-	



Türflügelprofile nach innen
Door leaf profiles inwards

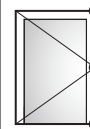
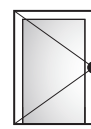
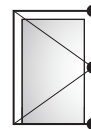
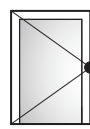
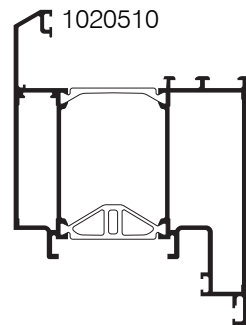
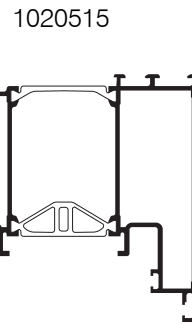
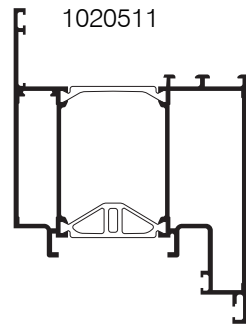

	(Pa)	800	400	800	800	400	800	-	-	-
	(Pa)	150	150	150	150	150	150	-	-	-
max.	FAB (m)	1.3	1.4	1.4	1.3	1.4	1.4	-	-	-
	FAH (m)	2.35*	2.35*	2.52*	2.35*	2.35*	2.52*	-	-	-
min.	GF FAB (m)	0.6	0.6	0.6	0.6	0.6	0.6	-	-	-
	SF FAB (m)	-	-	-	-	-	-	-	-	-
	FAH (m)	-	-	-	-	-	-	-	-	-
	min.	FAB (m)	-	-	-	-	-	-	-	-
	min.	FAH (m)	-	-	-	-	-	-	-	-
	min.	FAB (m)	-	-	-	-	-	-	-	-
	min.	FAH (m)	-	-	-	-	-	-	-	-
	max. (kg)	200			200			-		

* FAH > 2.2 m zusätzliches Mittelband erforderlich

* FAH > 2.2 m additional centre hinge required



Türflügelprofile nach innen
Door leaf profiles inwards

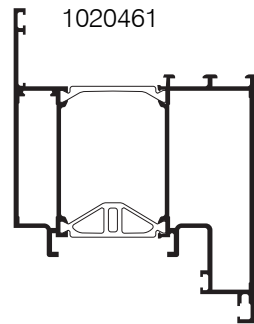

1020461

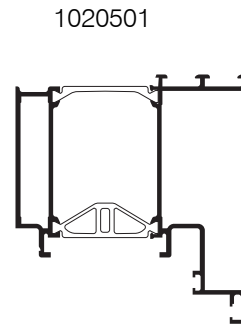

1020501

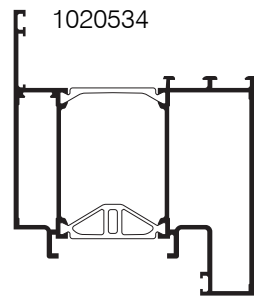

1020534

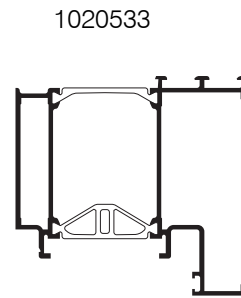

1020533

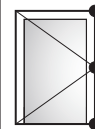
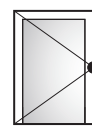
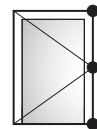
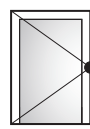

	(Pa)	800	400	800	800	400	800	-	-	-
	(Pa)	150	150	150	150	150	150	-	-	-
max.	FAB (m)	1.3	1.4	1.4	1.3	1.4	1.4	-	-	-
	FAH (m)	2.35*	2.35*	2.52*	2.35*	2.35*	2.52*	-	-	-
min.	GF FAB (m)	0.6	0.6	0.6	0.6	0.6	0.6	-	-	-
	SF FAB (m)	-	-	-	-	-	-	-	-	-
	FAH (m)	-	-	-	-	-	-	-	-	-
	min.	FAB (m)	-	-	-	-	-	-	-	-
		FAH (m)	-	-	-	-	-	-	-	-
	min.	FAB (m)	-	-	-	-	-	-	-	-
		FAH (m)	-	-	-	-	-	-	-	-
	max. (kg)	200			200			-		

* FAH > 2.2 m zusätzliches Mittelband erforderlich

* FAH > 2.2 m additional centre hinge required

	Seite Page
Serienbeschreibung <i>Description of series</i>	3/3
Profilübersicht <i>Survey of profiles</i>	3/11
Blendrahmenprofile <i>Frame profiles</i>	3/23
Sockelprofile <i>Bottom rail profiles</i>	3/38
Flügelprofile <i>Sash profiles</i>	3/40
Kämpfer, Sprossenprofile <i>Transom, glazing bar profiles</i>	3/47
Stützenprofile <i>Mullion profiles</i>	3/55
Kupplungsprofile <i>Coupling profiles</i>	3/70
Schwellenprofile <i>Threshold profiles</i>	3/71
Wetterschenkelprofile <i>Weatherproofing profiles</i>	3/73
Aufsatzprofile <i>Supplementary profiles</i>	3/74
Abdeckprofile <i>Cover profiles</i>	3/84
Zusatzprofile <i>Additional profiles</i>	3/85
Anwendungsbeispiele <i>Examples of application</i>	3/86
Glasleistenprofile, Auswahltabellen <i>Glazing bead profiles, selection tables</i>	3/134
Zulässige Flügelgrößen <i>Admissible sash sizes</i>	3/137

WICSTYLE 65 ist eine wärmegeämmte Türserie mit 65 mm Profilbautiefe.

Öffnungsarten:

Mit Spezialblendrahmen:

- Ein- und zweiflügelige Anschlagtüren, nach innen und nach außen öffnend
- Mittelstoß bei zweiflügeligen Türen wahlweise mit oder ohne Aufsatzprofil

Kombinationselemente mit WICLINE 65:

- Ein- und zweiflügelige Anschlagtüren, nach innen und nach außen öffnend
- Gegentakttüren
- Fingerschutztüren
- Pendeltüren
- Ganzglastüren
- Mit Oberlicht-Kippflügeln der Serie WICLINE 65
- Feste und bewegliche Seitenteile je nach Funktionsbedarf und Beschlägeanwendung

Profilbautiefen:

- 65 mm: Blendrahmen-, Kämpferprofile und flächenbündige Tür-Flügel-Profile, Klassik-Design mit Zusatzprofilen.
- 75 mm: Fenster-Überschlagflügelprofile im Oberlicht.

Profiltechnik:

- Hauptprofile im Dreikammersystem.
- Profil-Wärmeverbund kraft- und formschlüssig, qualitätsgesichert im Presswerk hergestellt.
- Außenansichtsbreiten:
 - Blendrahmenprofile von 48 mm bis 75 mm
 - Kämpferprofile von 73 mm bis 290 mm
 - Sockelprofile 107 mm bis 147 mm
 - Tür-Flügelprofile, einwärts 73 mm, 83 mm und 98 mm
 - Tür-Flügelprofile, auswärts 98 mm, 108 mm und 123 mm
- Türflügel wahlweise mit umlaufendem Flügelprofil oder mit unterem Sockelprofil
- Wetterschenkel flächenbündig
- Türschwollenprofile in Aluminium, thermisch getrennt mit Dichtungsanschlag
- Schwellenvarianten ohne thermische Trennung für Absenkrichtungen vorhanden
- Türflügelprofile für flügelüberdeckende Füllungen
- Stützenprofile nach innen und außen verstärkt.
- Dehnprofile für vertikalen Elementstoß, Standard und verstärkt.
- Scheibentrennende Sprossen als Verbundprofil.
- Die Glasanschlüsse der Türflügel- bzw. Rahmenprofile werden mit 30° abgeschrägten Zusatzprofilen auf Klassik-Design-Charakter umgerüstet.
- Zusatzprofile für Profilkombinationen, Verglasungen und Bauanschlüsse.

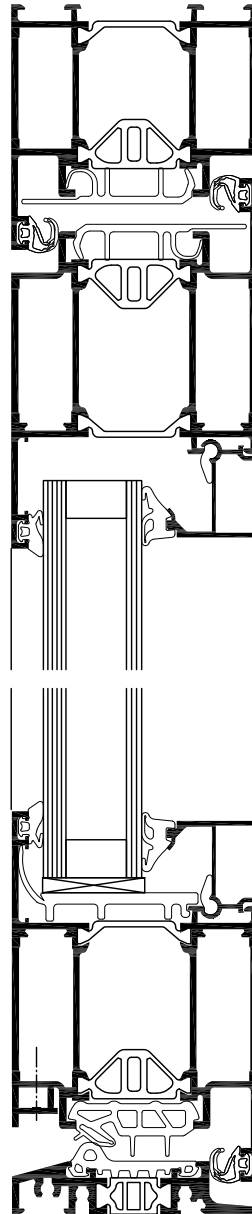

Anschlagtür, einwärts mit Spezialblendrahmen und Flügelprofil umlaufend

Hinged door with special frame and all-around leaf profile, inwards

WICSTYLE 65 is a thermally insulated door series with 65 mm construction depth.

Opening types:

With special frame profile:

- Single and double leaf hinged doors, inwards and outwards
- Meeting stiles of double leaf doors optionally with or without supplementary profiles

Combination units with WICLINE 65:

- Single and double leaf hinged doors, inwards and outwards
- Push-pull doors
- Finger protection doors
- Double action doors
- Glass doors
- With fanlight tilt sashes of WICLINE 65 series
- Fixed and movable lateral parts according to functional requirement and fittings application

Profile construction depths:

- 65 mm: Frame and transom profiles, flush fitting door leaf profiles. Renovation with supplementary profiles.
- 75 mm: Overlapping window sash profiles in fanlight.

Profile technique:

- Main profiles in three chamber system.
- Shape and force locking thermal compound profiles, quality-assured manufacture at the extrusion plant.
- Outer sight lines:
 - Frame profiles from 48 mm up to 75 mm
 - Transom profiles from 73 mm up to 290 mm
 - Bottom rail profiles 107 mm up to 147 mm
 - Inward opening door leaf profiles 73 mm, 83 mm and 98 mm
 - Outward opening door leaf profiles 98 mm, 108 mm and 123 mm
- Optionally, circumferential (all-around) door leaf profiles or with bottom rail profile
- Flush fitting weather bar profile
- Thermally insulated aluminium threshold profiles with gasket stop
- Optionally threshold variants without thermal break for lowering gaskets
- Door leaf profiles for leaf overlapping infills
- Internally and externally reinforced mullion profiles.
- Standard and reinforced expansion joint profiles for vertical unit joint.
- Glass partitioning composite glazing bar profiles.
- The outer stop web of frame and leaf glazing rebates can be changed over to Classic design characteristics with 30° bevelled supplementary profile.
- Supplementary profiles for profile combinations, glazings and junctions to structure.

Serienbeschreibung - Fortsetzung

Wärmedämmverbundleisten:

Durchgehende Wärmedämmleisten aus hochwertigem Kunststoff, faserverstärkt, wärmebeständig bis 200°C/15 Minuten.

Profilverbindungstechnik:

- Rahmenecken (Gehungsecken) mit hohlkammerfüllenden Spreiz-Gusseckwinkeln, mechanisch gesichert und mittels einseitiger Klebstoffinjektion zusätzlich verklebt. Mechanische Sicherung wahlweise mit Hülsen, Bolzen, Kegelschrauben oder Presstaverbindung.
- Eckverbinder wahlweise aus Al-Strangpress-Eckwinkeln im Selbstzuschnitt, mechanisch gesichert und geklebt.
- Profilstöße (Kämpferstoßverbindungen) mit Aluminiumverbindern, mechanisch gesichert und mittels Klebstoffinjektion zusätzlich verklebt. Mechanische Sicherung wahlweise mit Hülsen, Bolzen oder Kegelschrauben.
- Gehungsecken und Kämpferstoßverbindungen mit Kunststoff-Formteilen hinterlegt für nachträgliche Kleberinjektion.

Dichtungsprofile:

- Anschlagdichtungen in den Türflügelprofilen aus EPDM, innen und außen mit Formecken.
- Verglasungsdichtungen aus EPDM/EPDM Schaum, außen und innen umlaufend (kein Gehungsschnitt notwendig).
- Großvolumige Schwellenanschlagdichtung aus EPDM mit seitlichen, kammerfüllenden Formecken.
- Schwellendichtung aus EPDM mit Abdeckung der thermisch getrennten Schwelle und Anschlagbereich zur Schwellenanschlagdichtung.

Dampfdruckausgleich und Entwässerung:

Generell gelten die üblichen Regeln der Fachliteratur und der Glasindustrie für Dampfdruckausgleich und Entwässerung für Profilsysteme.

Dampfdruckausgleich aus freien Falzräumen über Öffnungen an den tiefsten Stellen der Fälze. Bei Türflügeln mit Sockel und bei umlaufenden Flügelprofilen verdeckt nach unten über die Hohlkammer vor die Schwellendichtung. Wahlweise Falzentwässerung mit Abdeckkappen möglich.

Wärmedämmung:

U_f - Werte nach DIN EN ISO 10077.

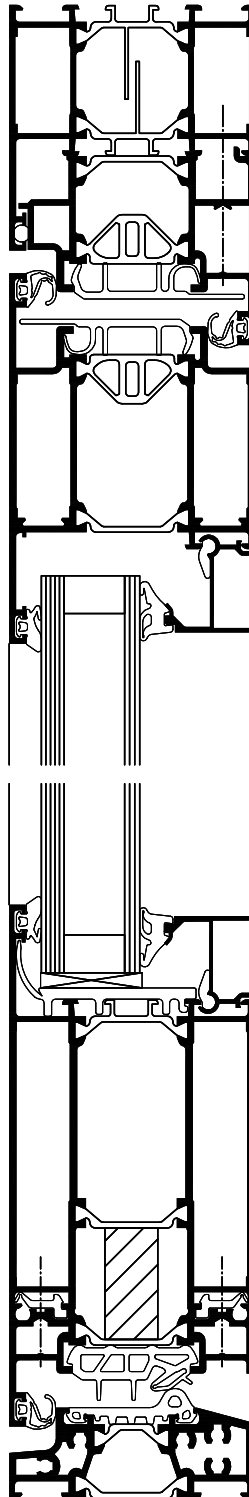

Anschlagtür, auswärts mit Kombinationsblendrahmen und Sockelprofil

Hinged door with combination frame and bottom rail profiles, outwards

Description of series - Continuation

Composite insulation strips:

Continuous thermal break strips made of high-grade plastic, fibre reinforced, heat resistant up to 200°C/15 minutes.

Profile connecting technique:

- Frame corners (mitre corners) connected by cavity-filling expanding cast aluminium corner angles, secured mechanically and additionally glued by injection procedure from one side. Mechanical safeguarding, optionally with drive bushes, bolts, conical screws or crimped connection.
- Optionally, corner angles made of extruded aluminium in self-cut, secured mechanically and glued.
- Profile butt-joints (transom butt-joints) with aluminium connectors, secured mechanically and glued additionally by injection procedure. Mechanical safeguarding, optionally with drive bushes, bolts or conical screws.
- Mitre corners and transom butt-joints backed by moulded plastic parts for subsequent glue injection.

Gasket profiles:

- Stop gaskets made of EPDM in door leaf profiles, inside and outside with moulded gasket angles.
- Circumferential (all-around) outer and inner glazing gaskets made of EPDM/EPDM foam (no mitre cut).
- Large-volume threshold stop gasket made of EPDM with lateral, chamber filling moulded gasket angles.
- Threshold gasket made of EPDM covering thermal break of threshold with end stop for leaf gasket.

Air pressure equalization and drainage:

Generally valid are the conventional rules of technical literature and glass industry for air pressure equalization and drainage.

Air pressure equalization from open rebate areas via openings at the lowest point of rebates. Concealed in door leaves with bottom rail and in circumferential (all-around) leaf profiles towards bottom via hollow chamber in front of threshold gasket. Optionally, rebate drainage with weep-hole covers is possible.

Thermal insulation:

U_f - value according to EN ISO 10077.

Serienbeschreibung - Fortsetzung

Beschläge:

RAL-geprüfte Türen mit systemabgestimmten Beschlägen und Türschließmitteln namhafter Hersteller. Tür-Rollenbänder in Aluminiumausführung und Aluminium-Aufschraubbänder. Zulässige Tür-Füllungsgewichte von 100 kg bis max. 200 kg, mit Einschränkungen bis 400 kg.

Oberflächenbehandlung der Profile:

Alle üblichen Eloxalverfahren nach DIN 17611 bzw. den Bestimmungen für das Gütezeichen für anodisch erzeugte Oxidschichten auf Aluminium Halbzeugen (Ausgabe 15. September 2004) der Qualanod Zürich, CH-8027 Zürich und Beschichtungsverfahren nach Erlangung eines Gütezeichens für Beschichtungen auf Aluminium durch Pulver- oder Nasslackierungen bei Architekturanwendungen (Ausgabe 1. April 2006) der Qualicoat Gütegemeinschaft, Zürich, CH-8027 Zürich sind auszuführen. Unterschiedliche Farbgestaltungen der Innen- und Außenprofilschalen vor dem Verbinden sind möglich.

Verglasungen:

Die allgemeinen Verglasungsvorschriften der Glasindustrie sind zu beachten. Verglasung, Trockenverglasung zwischen Elastomer-Dichtungen.

- Klotzung auf systemeigenen Kunststoff-Vorklötzen.
- Allgemeine Verklotzungsvorschriften sind zu beachten.
- Füllungsdicken von 3 - 50 mm im Standard Profilsystem (siehe auch Verglasungstabellen).

Systemkombinationen:

- WICSTYLE 65 Türen sind kombinierbar mit WICLINE 65 Fenster.
- Mit Einspannblendrahmen für WICLINE 65 in die aktuellen WICTEC-Fassaden-Programme einsetzbar.

Description of series - Continuation

Fittings:

RAL-tested doors with system specific fitting and door closers of renowned manufacturers. Aluminium butt hinges and surface mounted screwed hinges. Admissible door infill weights from 100 kg up to maximum 200 kg, with restrictions up to 400 kg.

Surface treatment of profiles:

All conventional anodic treatments should be carried out according to DIN 17611 and quality mark clauses for oxide layers on semi-finished aluminium (15th september 2004 Edition) of Qualanod Zürich, CH-8027 Zürich and coating procedures after obtainment of a quality mark for powder or wet coatings on aluminium in architectural applications (1st April 2006 Edition) of Qualicoat Gütegemeinschaft, Zürich, CH-8027 Zürich. Different colour shades of inner and outer profile shells are possible prior to connecting.

Glazings:

Consider the general prescriptions of glass industry. Glazings between elastomer gaskets (dry glazing).

- Shimming on system plastic shims.
- General shimming regulations should be considered.
- Infill thicknesses from 3 up to 50 mm in standard profile system (see also glazing tables).

System combinations:

- WICSTYLE 65 doors can be combined with WICLINE 65 windows.
- Can be integrated into the current WICTEC façade range using the WICLINE 65 clamping frame.

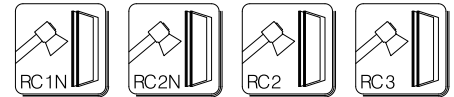

Einbruchhemmende Ausführung

Vorbemerkung:

WICSTYLE 65/75 Türen einbruchhemmend, mit und ohne Panikfunktion sind nach DIN EN 1627:2011 in den Widerstandsklassen RC 1 N/ RC 2 N/ RC 2 / RC 3 geprüft. Sie sind eine Ergänzung zur Standardserie. Sämtliche Merkmale, Eigenschaften, sowie die Verarbeitung bleiben unverändert. Die einbruchhemmenden Eigenschaften in den einzelnen Widerstandsklassen werden ausschließlich erreicht durch:

- Geprüfte Einsteck- oder Mehrfachverriegelungsschlösser klassifiziert nach EN 12209
- Standard Beschläge in Verbindung mit Anbohrschutz, oder wahlweise Schutzbeschläge klassifiziert nach EN 1906
- Bandseitensicherung mittels Abdeckprofil bei freier Bandauswahl
- Verglasungen, Sandwich- oder Glaspaneelle, klassifiziert nach EN 356
- zusätzliche Füllungssicherung bei Widerstandsklasse RC 2/ RC 3

Öffnungs- und Ausführungsarten:

In allen Widerstandsklassen sind 1- und 2- flügelige Türen in den Standard-Ausführungsvarianten, ein- und auswärts öffnend, sowie mit oder ohne Schwelle möglich. Ebenso auch als Flucht- oder Paniktüren.

RC 1 N/RC 2 N:

- 1-flügelige Standard- oder Fluchttüren nach EN 179 / EN 1125
- 2-flügelige Standard- oder Fluchttüren nach EN 179 / EN 1125 in Ausführung Teilpanik oder Vollpanik

RC 2:

- 1-flügelige Standard- oder Fluchttüren nach EN 179 / EN 1125
- 2-flügelige Standard- oder Fluchttüren nach EN 179 / EN 1125 in Ausführung Teilpanik oder Vollpanik (mit Mehrfachverriegelungsschlössern, 3-fach)

RC 3:

- 1-flügelige Standard- oder Fluchttüren nach EN 179 / EN 1125
- 2-flügelige Standard- oder Fluchttüren nach EN 179 / EN 1125 in Ausführung Teilpanik (mit Mehrfachverriegelungsschlössern 3-fach)

Sicherung der Füllungen:



Grundsätzlich keine Füllungssicherung erforderlich; Zusätzliche Distanzverklötzung bei FH > 1.500 mm



Trockensicherung, oder wahlweise Nassverklebung; Flucht-/Paniktüren nur mit Nassverklebung



Nassverklebung

Burglar resistant version

Preliminary remarks:

WICSTYLE 65/75 burglar resistant doors, with or without panic function have been tested to DIN EN 1627:2011 for the resistance classes RC 1 N/ RC 2 N/ RC 2/ RC 3. They are a complement to the standard series. All features, properties as well as the manufacturing process remain unchanged. The burglar resistant properties in the specific burglar resistant classes are achieved exclusively through:

- Tested mortise or multi-point locks classified according to EN 12209
- Standard fittings in connection with drilling protection or selectively Protective fittings classified according to EN 1906
- Hinge sided safeguard by means of cover profile with free selection of hinges
- Glazings, sandwich or glass panels classified according to EN 356
- Additional infill safeguard for resistance class RC 2/ RC 3

Opening types and design types:

Single and double leaf doors in standard variants, opening inwards and outwards as well as with or without threshold in all resistant classes are possible. Likewise, also as escape or panic doors.

RC 1 N/RC 2 N:

- Single leaf standard or escape doors acc. to EN 179 / 1125
- Double leaf standard or escape doors acc. to EN 179 / 1125 in version partial- or full panic door

RC 2:

- Single leaf standard or escape doors acc. to EN 179 / 1125
- Double leaf standard or escape doors acc. to EN 179 / 1125 in version partial- or full panic door (with three-point locks)

RC 3:

- Single leaf standard or escape doors acc. to EN 179 / 1125
- Double leaf standard or escape doors acc. to EN 179 / 1125 in version partial panic door (with three-point locks)

Securing of the infills:



Basically no infill securing necessary; Additional distance shimming for FH > 1.500 mm



Dry securing or alternatively wet glueing; Escape/ panic doors only with wet glueing



Wet glueing



Durchschusshemmung nach DIN EN 1522 bis Klasse FB 4

Hinweise:

Anwendungsmöglichkeiten für Türen, Festfelder und deren Kombinationen, durchschusshemmend nach DIN EN 1522 FB4. Durch rationelle Sicherungen der durchschusshemmenden Al-Beplankungen auf vorhandenen Standard-Türen lassen sich nachfolgende Systeme herstellen:

WICSTYLE Türen, durchschusshemmend

Kombinationsmöglichkeiten mit

1. WICSTYLE Türen, einbruchhemmend
2. WICLINE Fenster, durchschusshemmend
3. WICLINE Fenster, durchschusshemmend / einbruchhemmend

Ausführungsvarianten, durchschusshemmend

- 1-flügelige Türen, ein- und auswärts öffnend
- 2-flügelige Türen, ein- und auswärts öffnend (Stulpflügel ohne Aufsatzprofil)
- Standard, oder einbruchhemmend
- Fluchttüren DIN EN 179 oder Paniktüren DIN EN 1125, auswärts öffnend
- Eingeschränkte durchschusshemmende Eigenschaften (Türsockel / Fusspunkt nicht durchschusshemmend)

Durchschusshemmende Eigenschaften:

Um die durchschusshemmenden Basiseigenschaften von Türen herzustellen sind zusätzliche Maßnahmen im Türfalzbereich erforderlich.

Zur Auswahl stehen verschiedene Ausführungsvarianten.

Bei Türen mit **vollständig** durchschusshemmenden Eigenschaften sind nur Türsockelausführungen in Verbindung mit Schwellenschlag und weiteren Zusatzmaßnahmen zulässig. Für diese Türausführungen gelten die Prüfzertifikate in vollem Umfang.

Zulässig sind auch Türen mit **eingeschränkten** durchschusshemmenden Eigenschaften bei denen der Fußbodenanschluss von der Durchschusshemmung ausgenommen ist.

Hierbei sind alle Varianten von Türsockelausführungen incl. durchlaufende oder barrierefreie Fußbodenanschlüsse möglich.

Achtung:

Bei diesen Türausfertigungen sind die Türsockel- und Schwellenausführungen von der Gültigkeit der Prüfzertifikate ausgenommen. Diese Ausnahmeregelung bedarf einer besonderen Zustimmung und Freigabe je nach Anwendungsfall. Eine separate Bescheinigung des Auftraggebers ist einzuholen.

Zu beachten:

Auf Durchschusshemmung geprüfte Profile sind

Türflügelprofile:

1926511, 1926514, 1927511, 1927514

Blendrahmenprofile:

1916004, 1917004

Kämpferprofile:

1916205, 1917205

Zusatzprofile:

1926520, 1927520, 1926522, 1927522 (Wechselprofile ein-/auswärts)

1926530, 1927530, 3925094

Bullet resistance according to DIN EN 1522 up to class FB 4

Remark:

Application possibilities for doors, fixed fields and their combinations, bullet resistant according to DIN EN 1522 FB4.

Following systems can be fabricated by efficient securing bullet resistant aluminium planking on existing standard doors:

WICSTYLE doors, bullet resistant

Combination possibilities with

1. WICSTYLE doors, burglar resistant
2. WICLINE windows, bullet resistant
3. WICLINE windows, bullet resistant / burglar resistant

Design versions, bullet resistant

- Single leaf doors, inward and outward opening
- Double leaf doors, inward and outward opening (secondary leaf without supplementary profile)
- Standard, or burglary resistant
- Escape doors DIN EN 179 or panic doors DIN EN 1125, outward opening
- Restricted bullet resistant properties (bottom rail / base point not bullet resistant)

Bullet resistant properties:

To realize the basic bullet resistant properties of doors, additional measures have to be implemented in the door rebate area.

Various design versions are offered.

*For doors with **complete** bullet resistant properties, only door bottom rail designs combined with threshold stop and further additional measures are permitted.*

For these door designs, the test certificates are valid in their entirety.

*Also doors with **limited** bullet resistant properties where the floor junction area has no bullet resistant properties are permitted.*

In that case, all threshold design variants are possible including continuous or barrier-free floor junctions.

Careful:

For these door constructions, the door bottom rail and threshold designs are outside the scope of validity of the test certificates. This exemption regulation requires a specific approval and clearance related to the application.

A separate certificate issued by the awarding authority must be obtained.

Please note:

Profiles tested for bullet resistance are

Door leaf profiles:

1926511, 1926514, 1927511, 1927514

Frame profiles:

1916004, 1917004

Transom profiles:

1916205, 1917205

Supplementary profiles:

1926520, 1927520, 1926522, 1927522 (Reversion profiles in-/outward)

1926530, 1927530, 3925094

WICSTYLE 65 ist eine wärmegeädmmte Türserie mit 65 mm Profilbautiefe.

Öffnungsarten:

Mit Spezialblendrahmen:

- Ein- und zweiflügelige Anschlagtüren, nach innen und nach außen öffnend
- Mittelstoß bei zweiflügeligen Türen ohne Aufsatzprofil

Kombinationselemente mit WICLINE 65:

- Ein- und zweiflügelige Anschlagtüren, nach innen und nach außen öffnend
- Gegentaktüren
- Fingerschutztüren
- Halbspendeltüren
- Pendeltüren
- Ganzglastüren
- Mit Oberlicht-Kippflügeln der Serie WICLINE 65
- Feste und bewegliche Seitenteile je nach Funktionsbedarf und Beschlägeanwendung

Profilbautiefen:

- 65 mm: Blendrahmen-, Kämpferprofile und flächenbündige Tür-Flügelprofile, Altbausanierung mit Zusatzprofilen.

Profiltechnik:

- Hauptprofile im Dreikammersystem.
- Profil-Wärmeverbund kraft- und formschlüssig, qualitätsgesichert im Presswerk hergestellt.
- Außenansichtsbreiten:
 - Blendrahmenprofile von 48 mm bis 75 mm
 - Kämpferprofile von 73 mm bis 290 mm
 - Sockelprofile 98 mm
 - Tür-Flügelprofile, einwärts 73 mm
 - Tür-Flügelprofile, auswärts 98 mm
- Türflügel wahlweise mit umlaufendem Flügelprofil oder mit unterem Sockelprofil
- Wetterschenkel
- Türschwelleprofile in Aluminium, thermisch getrennt mit Dichtungsanschlag, entwässerbar
- Schwellenvarianten ohne thermische Trennung
- Stützenprofile nach innen und außen verstärkt.
- Dehnprofile für vertikalen Elementstoß, Standard und verstärkt.
- Scheibentrennende Sprossen als Verbundprofil.
- Zusatzprofile für Profilkombinationen, Verglasungen und Bauanschlüsse.

Wärmedämmverbundleisten:

Durchgehende Wärmedämmleisten aus hochwertigem Kunststoff, faserverstärkt, wärmebeständig bis 200°C/15 Minuten.

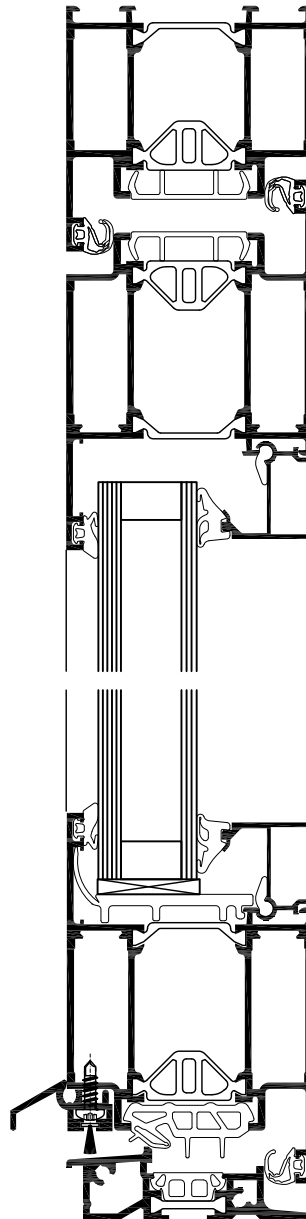

Anschlagtür, einwärts mit Spezialblendrahmen und Flügelprofil umlaufend

Hinged door with special frame and all-around leaf profile, inwards

WICSTYLE 65 is a thermally insulated door series with 65 mm construction depth.

Opening types:

With special frame profile:

- Single and double leaf hinged doors, inwards and outwards
- Meeting stiles of double leaf doors without supplementary profiles

Combination units with WICLINE 65:

- Single and double leaf hinged doors, inwards and outwards
- Push-pull doors
- Finger protection doors
- Single action doors
- Double action doors
- Glass doors
- With fanlight tilt sashes of WICLINE 65 series
- Fixed and movable lateral parts according to functional requirement and fittings application

Profile construction depths:

- 65 mm: Frame and transom profiles, flush fitting door leaf profiles. Renovation with supplementary profiles.

Profile technique:

- Main profiles in three chamber system.
- Shape and force locking thermal compound profiles, quality-assured manufacture at the extrusion plant.
- Outer sight lines:
 - Frame profiles from 48 mm up to 75 mm
 - Transom profiles from 73 mm up to 290 mm
 - Bottom rail profiles 98 mm
 - Inward opening door leaf profiles 73 mm
 - Outward opening door leaf profiles 98 mm
- Optionally, circumferential (all-around) door leaf profiles or with bottom rail profile
- Weather bar profile
- Thermally insulated aluminium threshold profiles with gasket stop, with drainage
- Optionally threshold variants without thermal break
- Internally and externally reinforced mullion profiles.
- Standard and reinforced expansion joint profiles for vertical unit joint.
- Glass partitioning composite glazing bar profiles.
- Supplementary profiles for profile combinations, glazings and junctions to structure.

Composite insulation strips:

Continuous thermal break strips made of high-grade plastic, fibre reinforced, heat resistant up to 200°C/15 minutes.

Serienbeschreibung - Fortsetzung

Profilverbindungstechnik:

- Rahmenecken (Gehrungsecken) mit hohlkammerfüllenden Spreiz-Gusseckwinkeln, mechanisch gesichert und mittels einseitiger Klebstoffinjektion zusätzlich verklebt. Mechanische Sicherung wahlweise mit Hülse, Bolzen, Kegelschrauben oder Presstaverbindung.
- Eckverbinder wahlweise aus Al-Strangpress-Eckwinkeln im Selbstzusschnitt, mechanisch gesichert und geklebt.
- Profilstöße (Kämpferstoßverbindungen) mit Aluminiumverbindern, mechanisch gesichert und mittels Klebstoffinjektion zusätzlich verklebt. Mechanische Sicherung wahlweise mit Hülse, Bolzen oder Kegelschrauben.
- Gehrungsecken und Kämpferstoßverbindungen mit Kunststoff-Formteilen hinterlegt für nachträgliche Kleberinjektion.

Dichtungsprofile:

- Anschlagdichtungen in den Türflügelprofilen aus EPDM, innen und außen mit Formecken.
- Verglasungsdichtungen aus EPDM/ EPDM Schaum, außen und innen umlaufend (kein Gehrungsschnitt notwendig).
- Großvolumige Schwellenanschlagdichtung aus EPDM mit seitlichen, kammerfüllenden Formecken.
- Schwellendichtung aus EPDM mit Abdeckung der thermisch getrennten Schwelle und Anschlagbereich zur Schwellenanschlagdichtung.

Dampfdruckausgleich und Entwässerung:

Generell gelten die üblichen Regeln der Fachliteratur und der Glasindustrie für Dampfdruckausgleich und Entwässerung für Profilsysteme.

Dampfdruckausgleich aus freien Falzräumen über Öffnungen an den tiefsten Stellen der Fälze. Bei Türflügeln mit Sockel und bei umlaufenden Flügelprofilen verdeckt nach unten über die Hohlkammer vor die Schwellen-Dichtung. Wahlweise Falzentwässerung mit Abdeckkappen möglich.

Wärmedämmung:

Uf - Werte nach DIN EN ISO 10077.

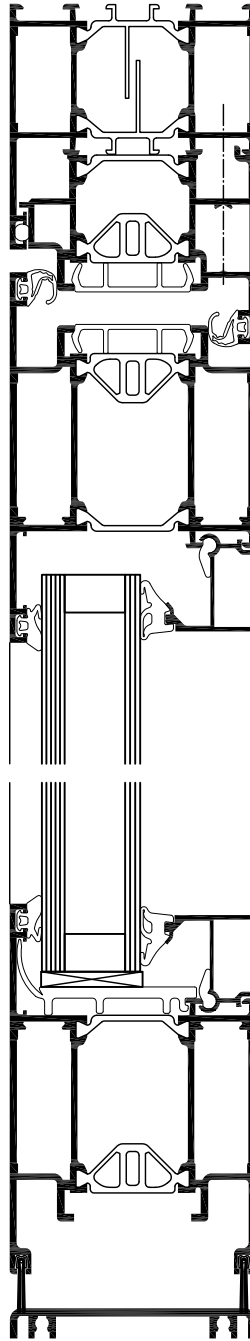

Description of series - Continuation

Profile connecting technique:

- Frame corners (mitre corners) connected by cavity-filling expanding cast aluminium corner angles, secured mechanically and additionally glued by injection procedure from one side. Mechanical safeguarding, optionally with drive bushes, bolts, conical screws or crimped connection.
- Optionally, corner angles made of extruded aluminium in self-cut, secured mechanically and glued.
- Profile butt-joints (transom butt-joints) with aluminium connectors, secured mechanically and glued additionally by injection procedure. Mechanical safeguarding, optionally with drive bushes, bolts or conical screws.
- Mitre corners and transom butt-joints backed by moulded plastic parts for subsequent glue injection.

Gasket profiles:

- Stop gaskets made of EPDM in door leaf profiles, inside and outside with moulded gasket angles.
- Circumferential (all-around) outer and inner glazing gaskets made of EPDM/ EPDM foam (no mitre cut).
- Large-volume threshold stop gasket made of EPDM with lateral, chamber filling moulded gasket angles.
- Threshold gasket made of EPDM covering thermal break of threshold with end stop for leaf gasket.

Air pressure equalization and drainage:

Generally valid are the conventional rules of technical literature and glass industry for air pressure equalization and drainage.

Air pressure equalization from open rebate areas via openings at the lowest point of rebates. Concealed in door leaves with bottom rail and in circumferential (all-around) leaf profiles towards bottom via hollow chamber in front of threshold gasket. Optionally, rebate drainage with weephole covers is possible.

Thermal insulation:

Uf - value according to EN ISO 10077.

Anschlagtür, auswärts mit Kombinationsblendrahmen und Sockelprofil

Hinged door with combination frame and bottom rail profiles, outwards

Serienbeschreibung - Fortsetzung

Beschläge:

RAL-geprüfte Türen mit systemabgestimmten Beschlägen und Türschließmitteln namhafter Hersteller.
Tür-Rollenbänder in Aluminiumausführung und Aluminium-Aufschraubbänder. Zulässige Tür-Füllungsgewichte von 100 kg bis max. 200 kg.

Oberflächenbehandlung der Profile:

Alle üblichen Eloxalverfahren nach DIN 17611 bzw. den Bestimmungen für das Gütezeichen für anodisch erzeugte Oxidschichten auf Aluminium Halbzeugen (Ausgabe 15. September 2004) der Qualanod Zürich, CH-8027 Zürich und Beschichtungsverfahren nach Erlangung eines Gütezeichens für Beschichtungen auf Aluminium durch Pulver- oder Nasslackierungen bei Architektur-anwendungen (Ausgabe 1. April 2006) der Qualicoat Gütegemeinschaft, Zürich, CH-8027 Zürich sind auszuführen. Unterschiedliche Farbgestaltungen der Innen- und Außenprofil-schalen vor dem Verbinden sind möglich.

Verglasungen:

Die allgemeinen Verglasungsvorschriften der Glasindustrie sind zu beachten. Verglasung, Trockenverglasung zwischen Elastomer-Dichtungen.

- Klotzung auf systemeigenen Kunststoff-Vorklötzen.
- Allgemeine Verklotzungsvorschriften sind zu beachten.
- Füllungsdicken von 3 - 50 mm im Standard Profilsystem (siehe auch Verglasungstabellen).

Systemkombinationen:

- WICSTYLE 65 Türen sind kombinierbar mit WICLINE 65 Fenster
- Mit Einspannblendrahmen für WICLINE 65 in die aktuellen WICTEC-Fassaden-Programme einsetzbar.

Description of series - Continuation

Fittings:

*RAL-tested doors with system specific fitting and door closers of renowned manufacturers.
Aluminium butt hinges and surface mounted screwed hinges.
Admissible door infill weights from 100 kg up to maximum 200 kg.*

Surface treatment of profiles:

*All conventional anodic treatments should be carried out according to DIN 17611 and quality mark clauses for oxide layers on semi-finished aluminium (15th september 2004 Edition) of Qualanod Zürich, CH-8027 Zürich and coating procedures after obtainment of a quality mark for powder or wet coatings on aluminium in architectural applications (1st April 2006 Edition) of Qualicoat Gütegemeinschaft, Zürich, CH-8027 Zürich.
Different colour shades of inner and outer profile shells are possible prior to connecting.*

Glazings:

Consider the general prescriptions of glass industry. Glazings between elastomer gaskets (dry glazing).

- *Shimming on system plastic shims.*
- *General shimming regulations should be considered.*
- *Infill thicknesses from 3 up to 50 mm in standard profile system (see also glazing tables).*

System combinations:

- *WICSTYLE 65 doors can be combined with WICLINE 65 windows.*
- *Can be integrated into the current WICTEC façade range using the WICLINE 65 clamping frame.*

Profilübersicht
Survey of Profiles

Blendrahmenprofile
Frame profiles

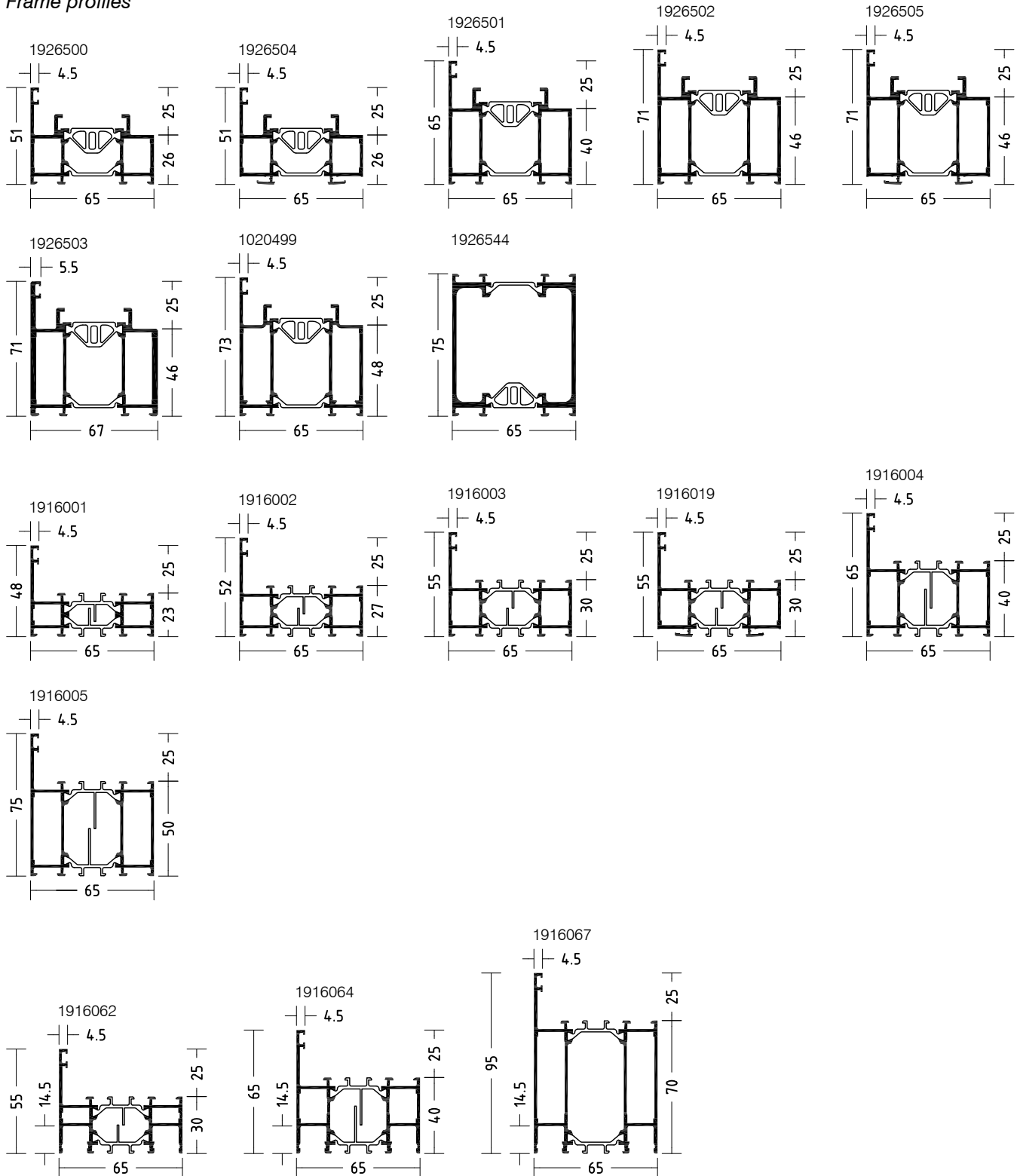

Profilübersicht
Survey of Profiles

Blendrahmenprofile
Frame profiles

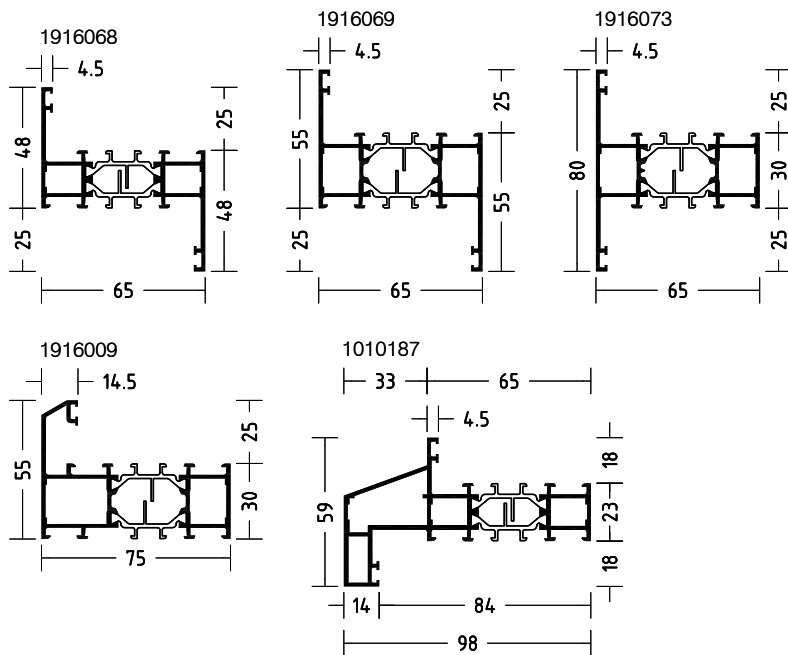

Einspann-Blendrahmenprofile
Clamping frame profiles

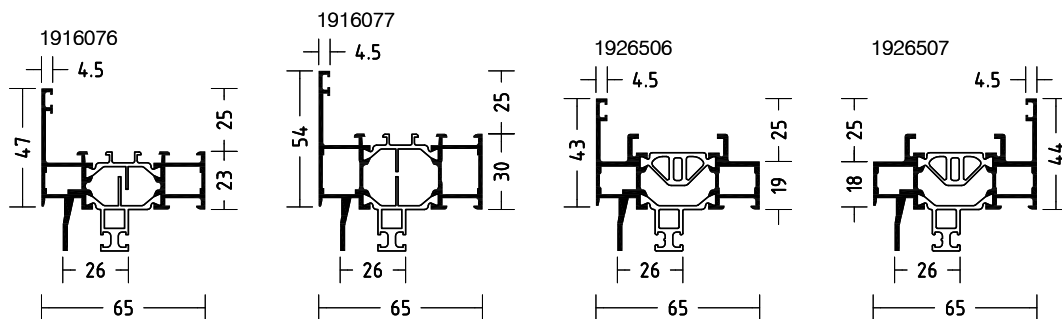

Profilübersicht
Survey of Profiles

Flügelprofile nach Innen öffnend

Leaf profiles inwards

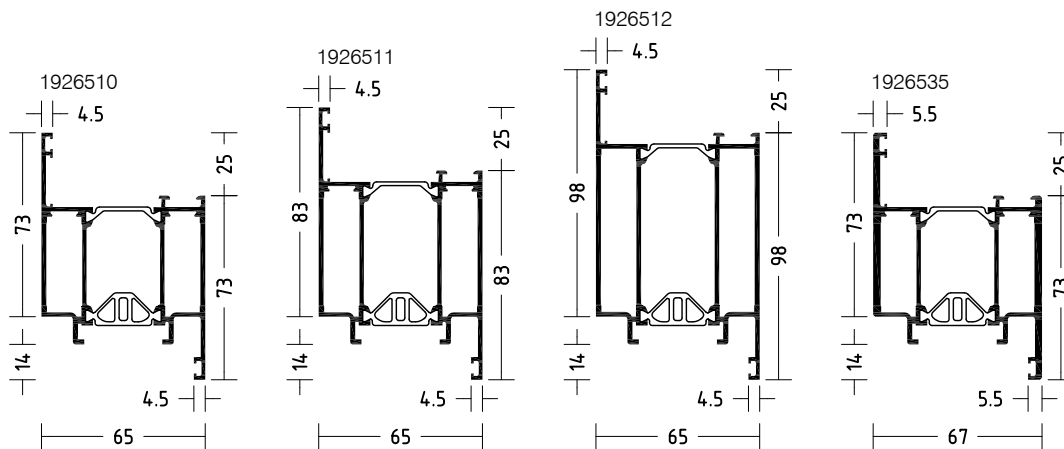

Flügelprofile nach Außen öffnend

Leaf profiles outwards

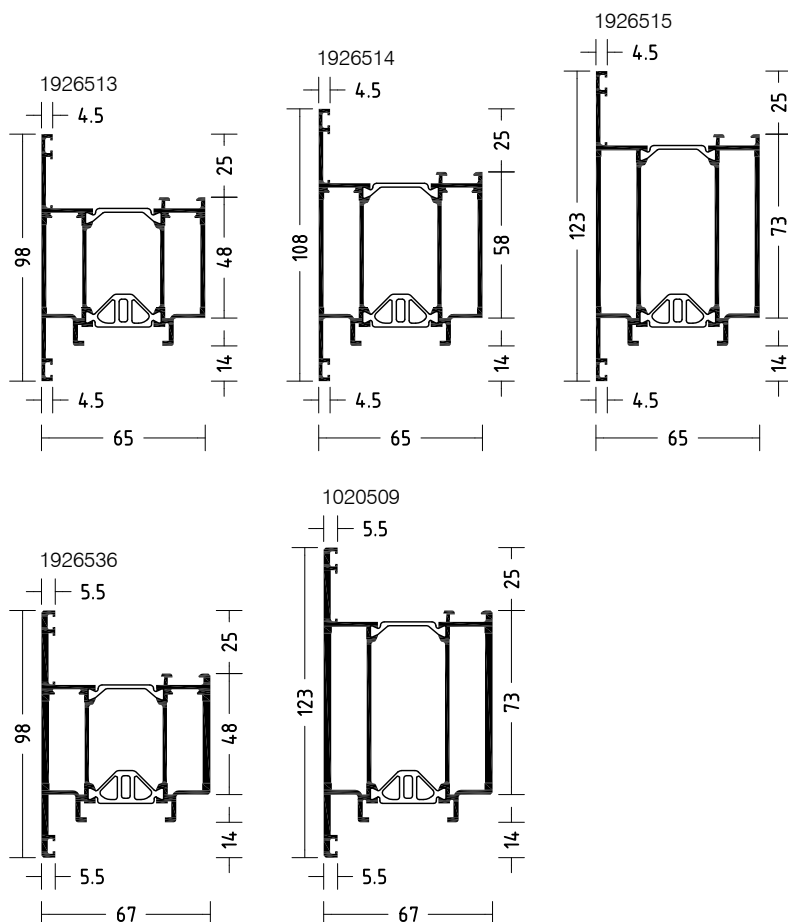

Profilübersicht
Survey of Profiles

Flügelprofil für einseitig flügelüberdeckende Füllung

Leaf profile for single-sided leaf overlapping infill

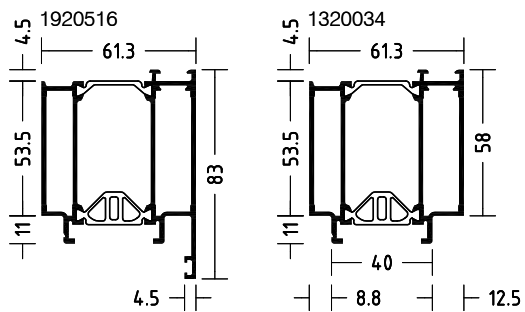

Flügelprofil für beidseitig flügelüberdeckende Füllung

Leaf profile for both-sided leaf overlapping infill

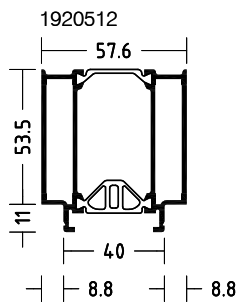

Sockelprofile

Bottom rail profiles

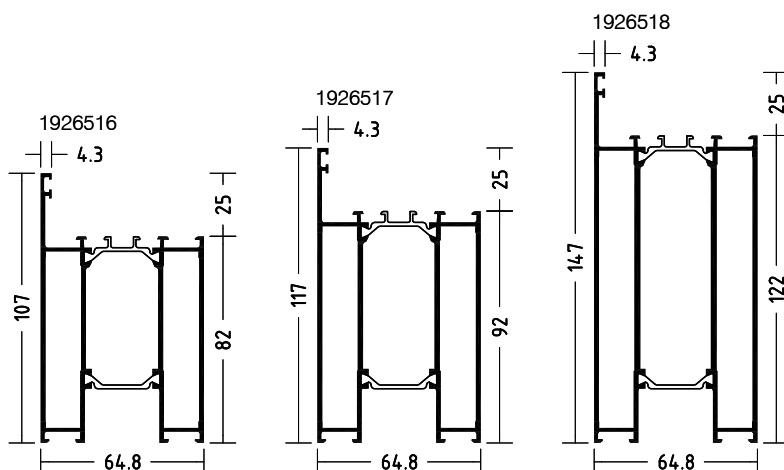

Profilübersicht
Survey of Profiles

Falzverbreiterungsprofile
Rebate widening profiles

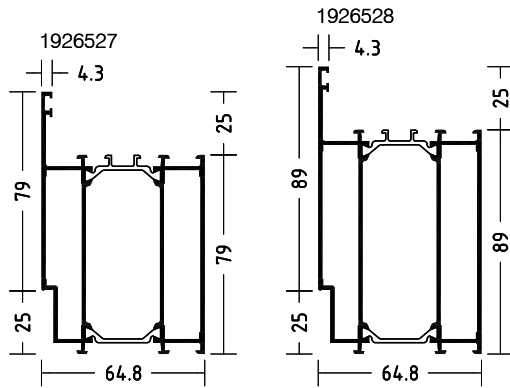

Kämpferprofile
Transom profiles

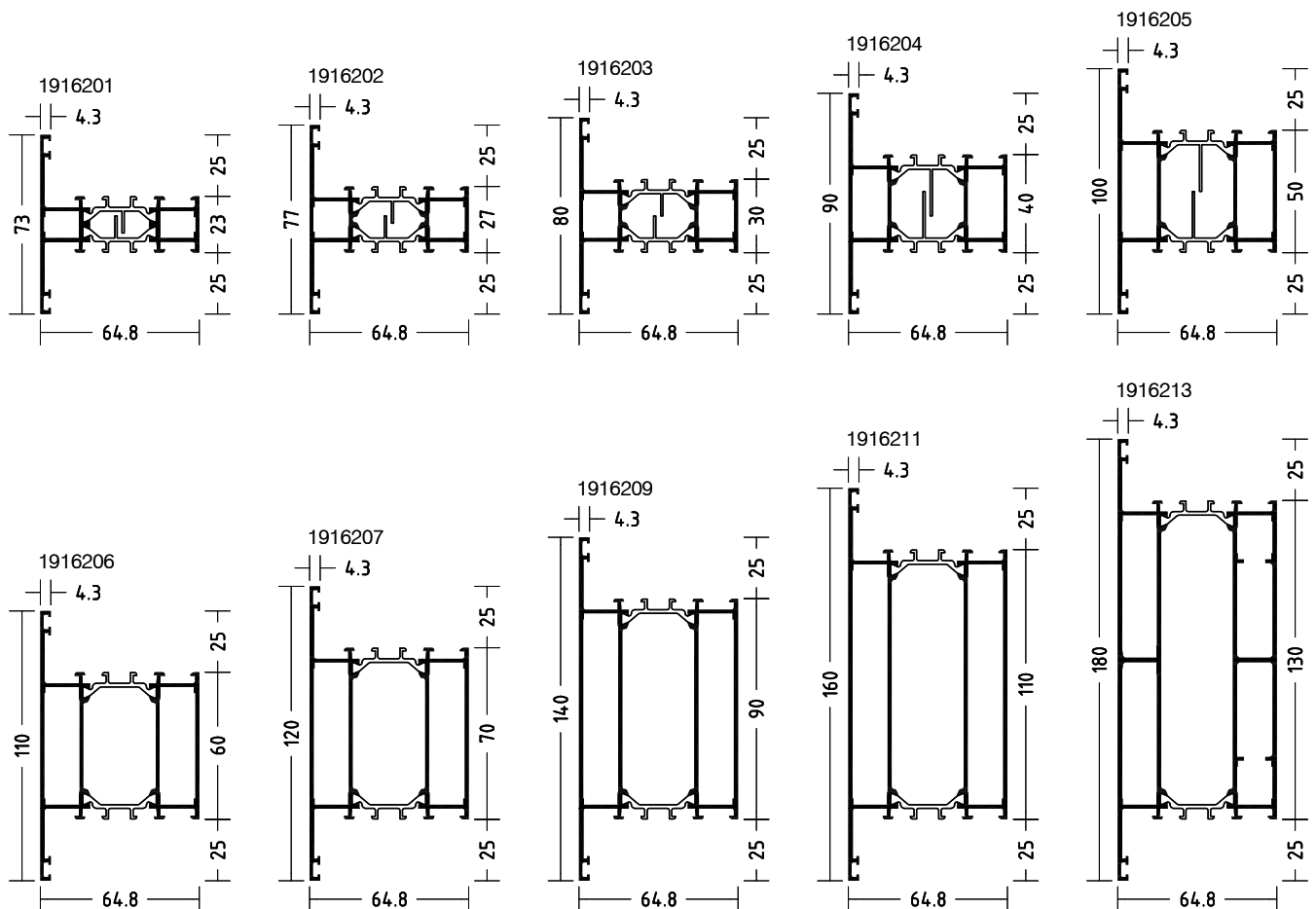

Profilübersicht
Survey of Profiles

Kämpferprofile
Transom profiles

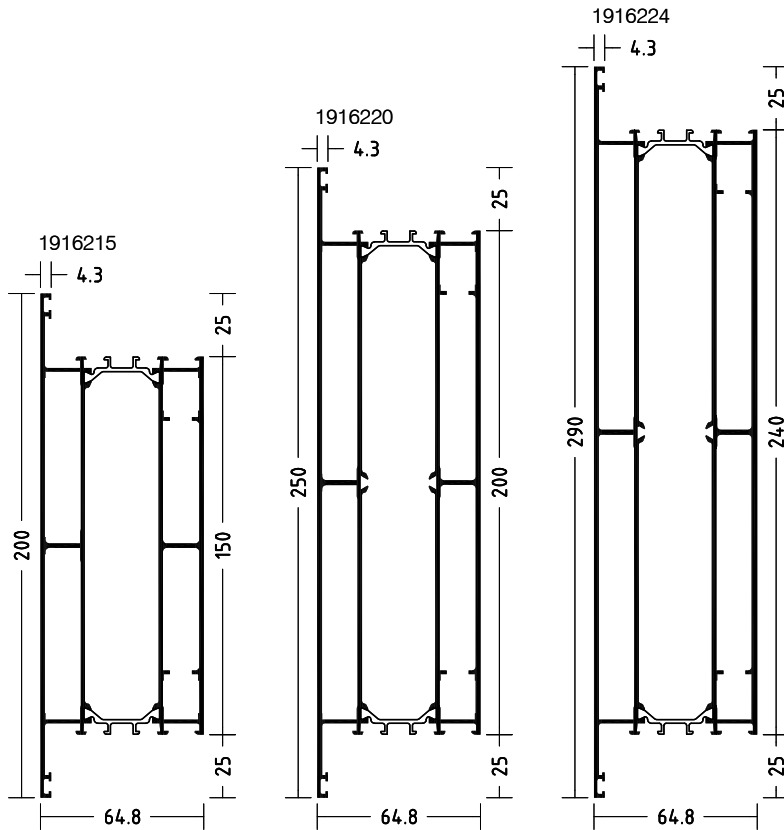

Stützenprofile geteilt nach außen verstärkt
Externally reinforced split mullion profiles

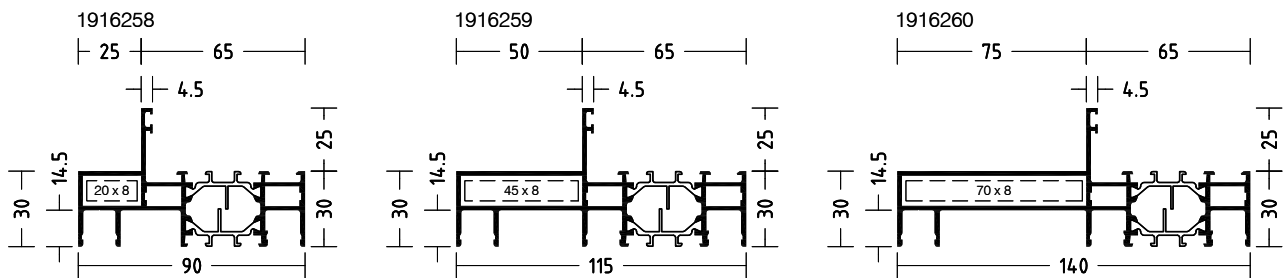

Stützenprofil geteilt nach innen verstärkt
Internally reinforced split mullion profile

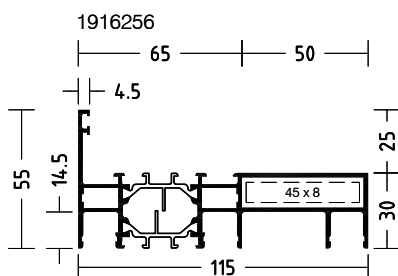

Profilübersicht
Survey of Profiles

Stützenprofile nach außen verstärkt
Externally reinforced mullion profiles

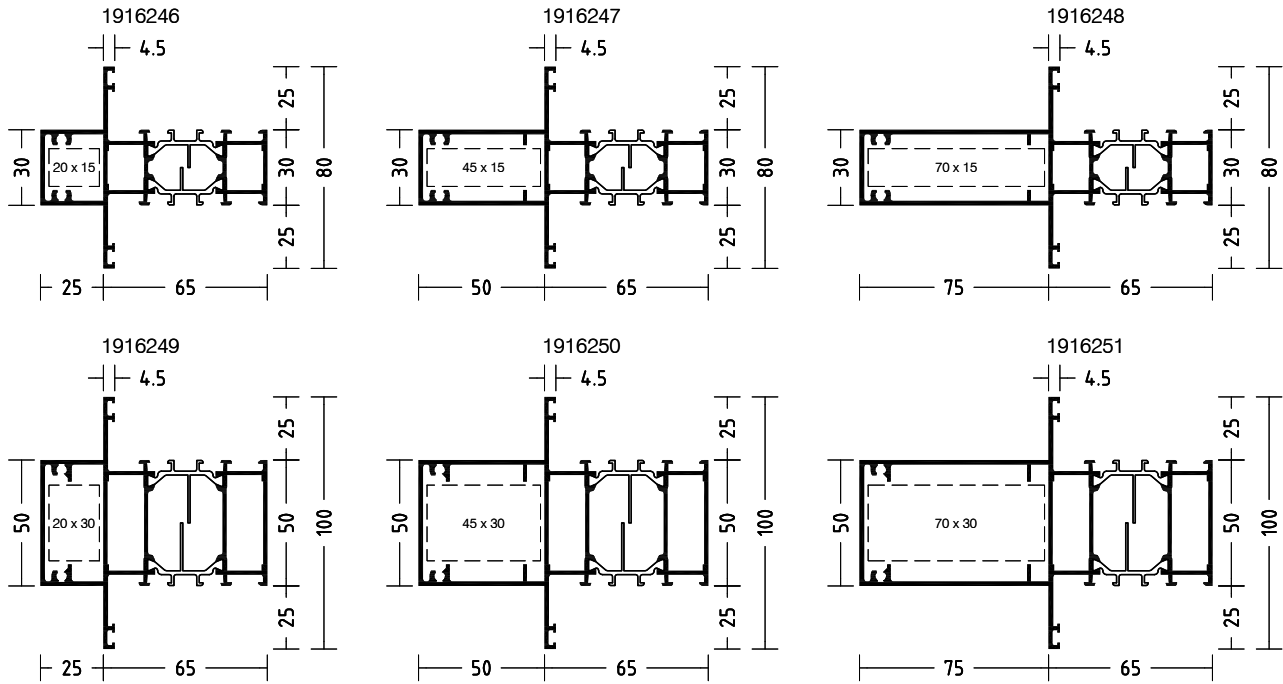

Stützenprofile nach innen verstärkt
Internally reinforced mullion profiles

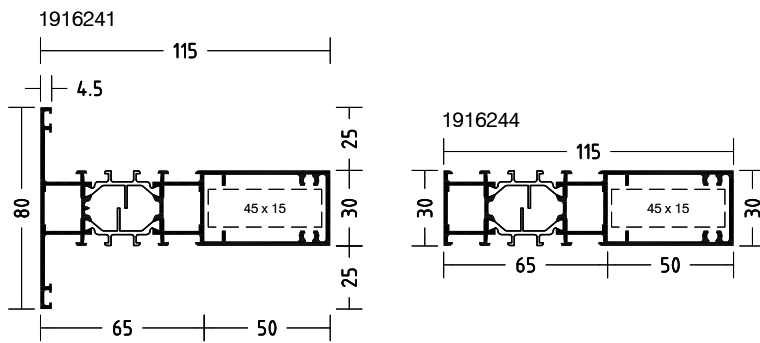

Profilübersicht
Survey of Profiles

Stützenprofile
Mullion profiles

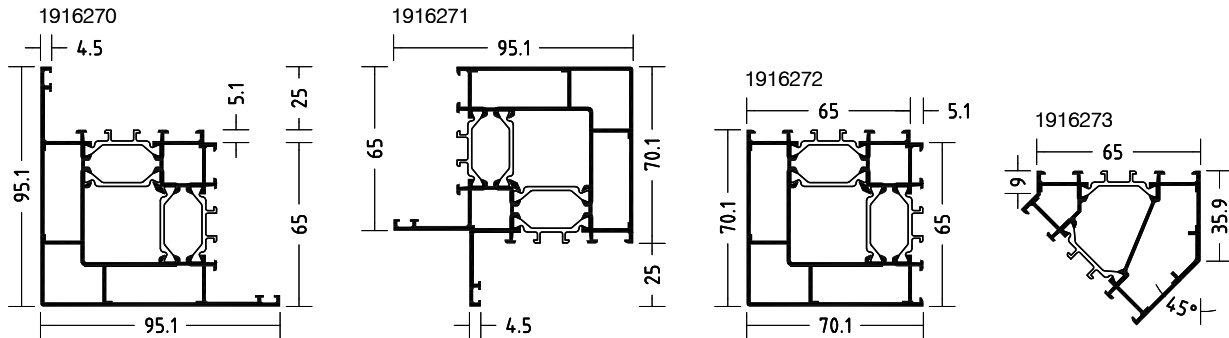

Sprossenprofile
Glazing bar profiles

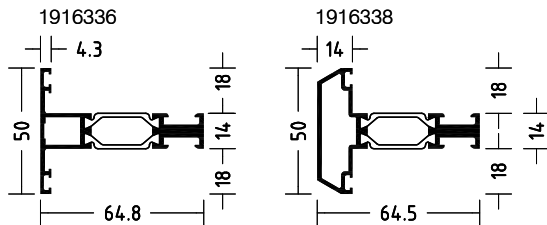

Schwellenprofile
Threshold profiles

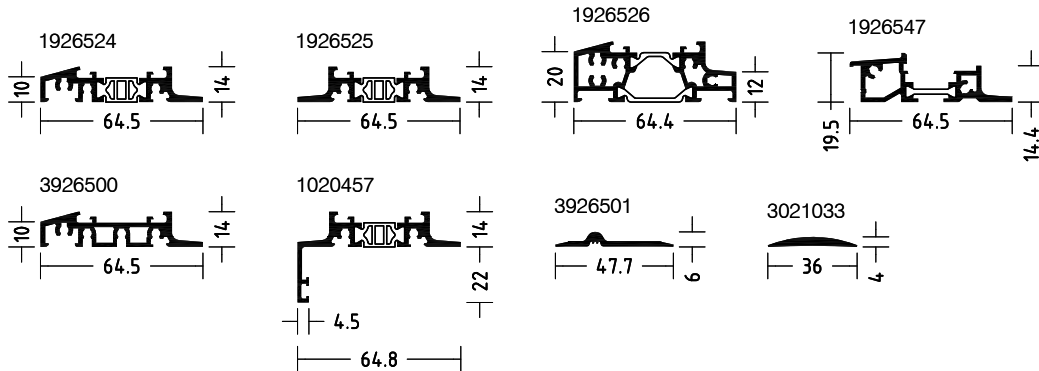

Profilübersicht
Survey of Profiles

Aufsatzprofile
Supplementary profiles

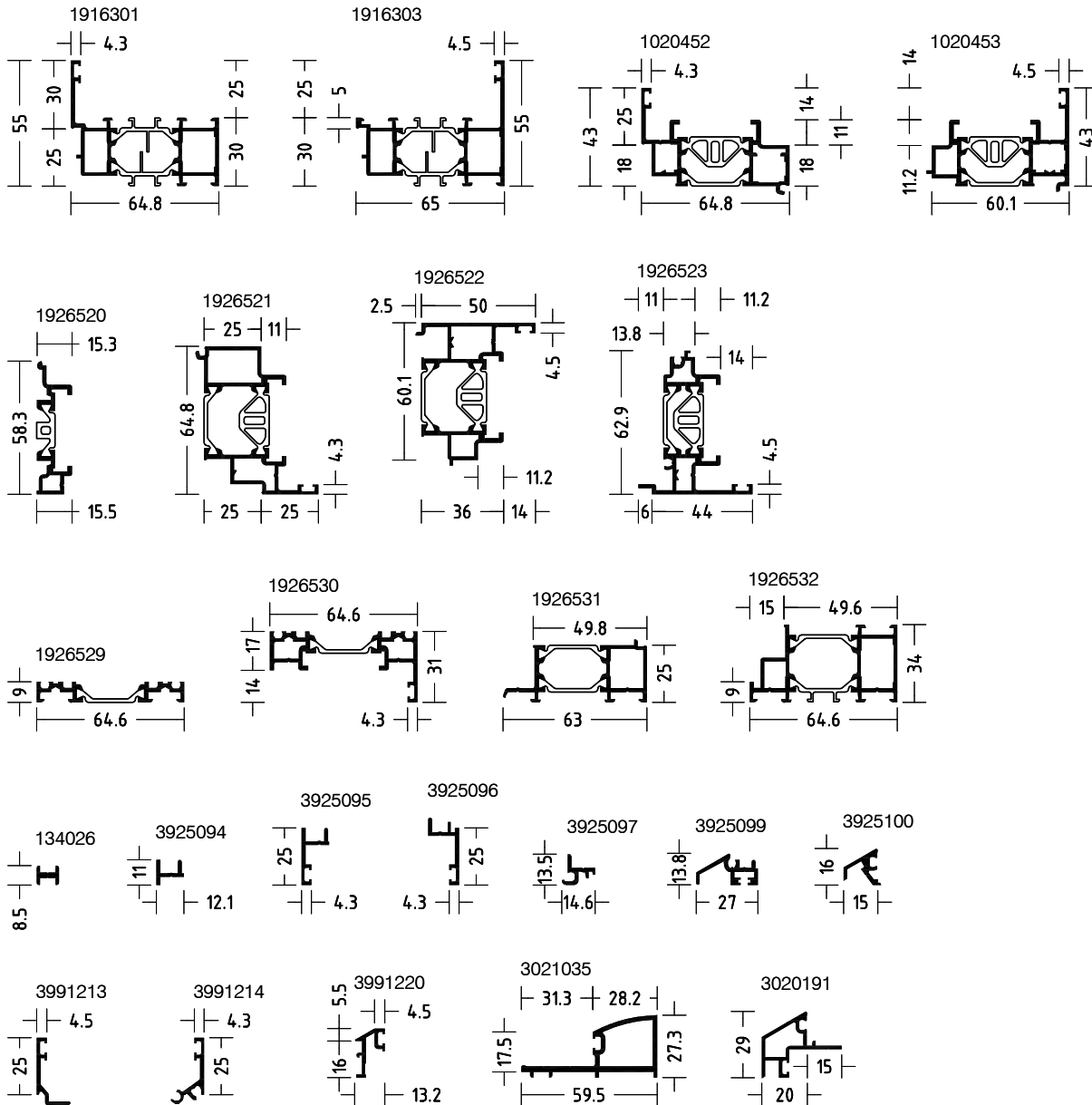

WICSTYLE 65 evo / 65

Technische Information
Technical Information

Profilübersicht
Survey of Profiles

Neutralprofile
Neutral profiles

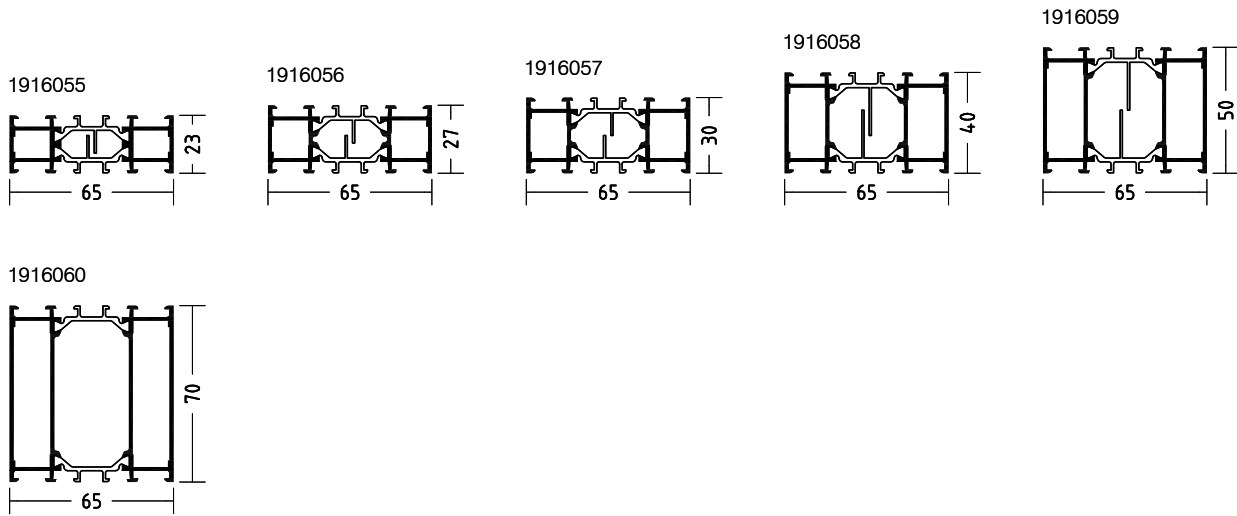

Profilübersicht
Survey of Profiles

Blendrahmenprofile
Frame profiles

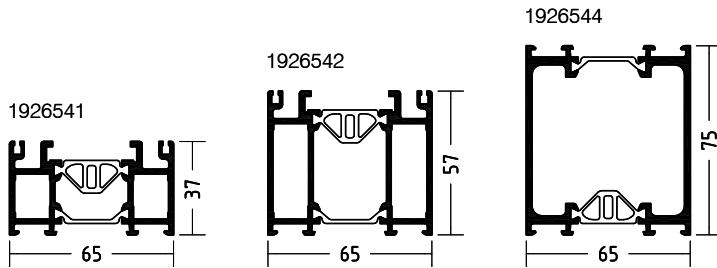

Flügelprofile
Sash profiles

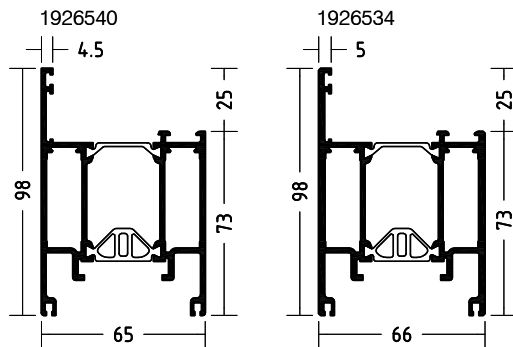

Zusatzprofile
Additional profiles

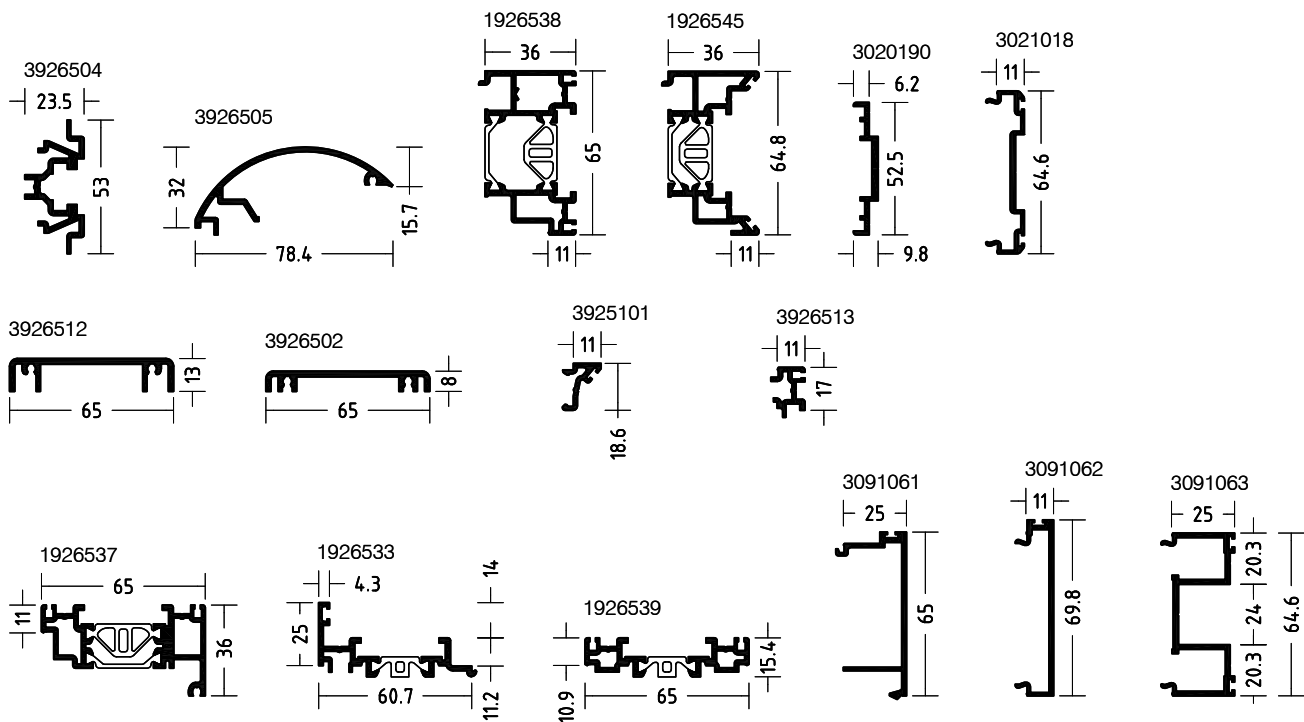

Profilübersicht Survey of Profiles

Glasleistenprofile 18 mm

Glazing bead profiles 18 mm

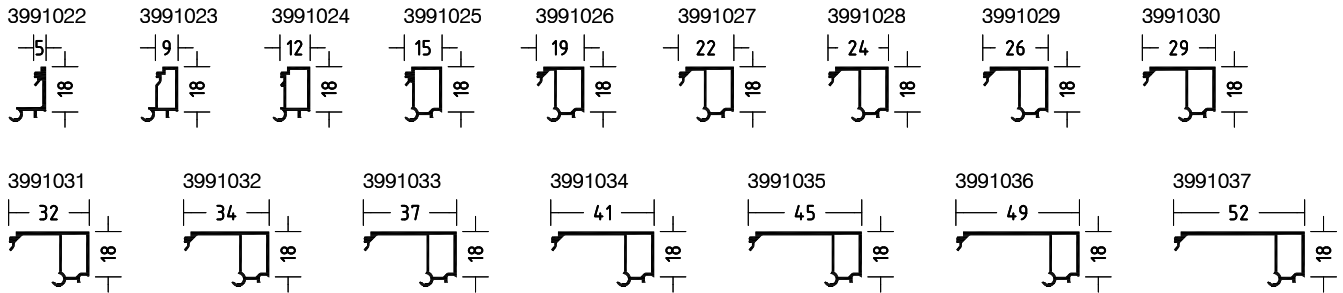

Glasleistenprofile 22 mm

Glazing bead profiles 22 mm

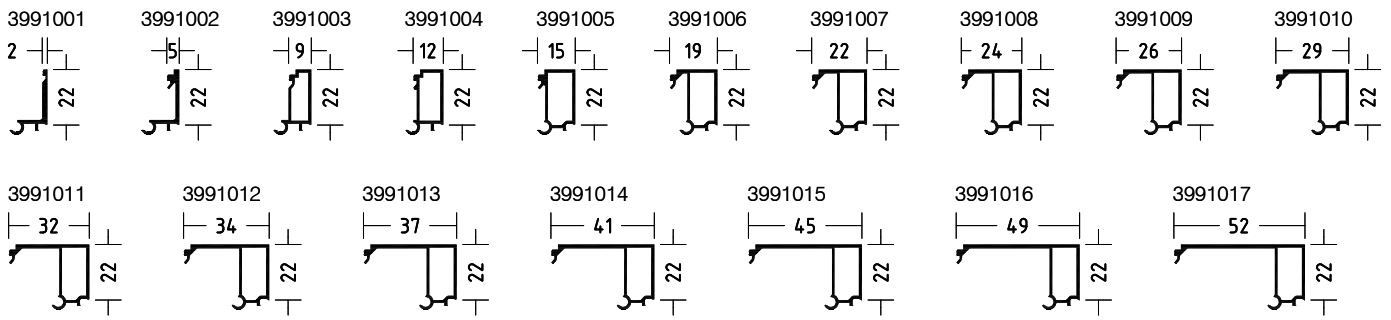

Glasleistenprofile Trockenverglasung / Nassverglasung

Glazing bead profiles dry glazing / wet glazing

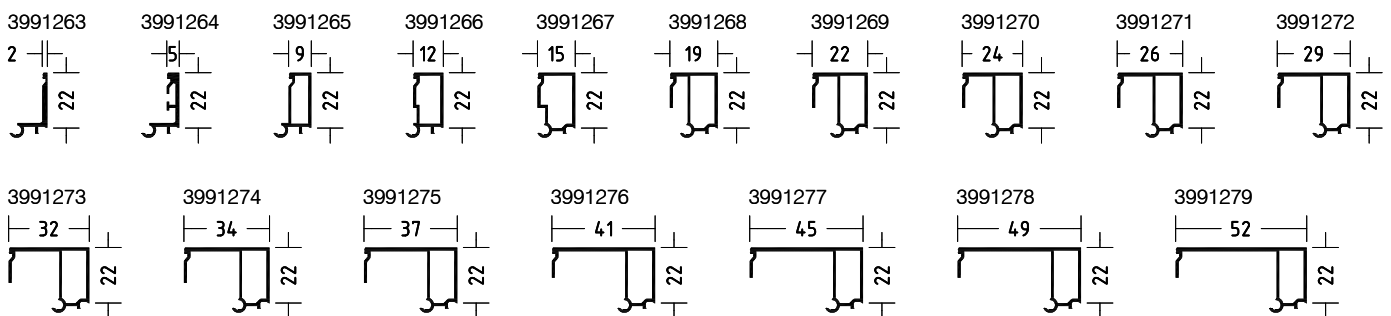

		m	mm	mm									
	1916001	6,5	285	71									
					4950006	2x4070000	1x4960002	1x4070000	-	5910004	5940101	5940001	5930001
					4950006	2x4070000	1x4960002	1x4070000	-	5910004	5940101	5940001	5930001
	1916002	6,5	293	79	4950007	2x4070000	1x4960003	1x4070000	1x4070030	5910004	5940101	5940001	5930001
					4950007	2x4070000	1x4960003	1x4070000	1x4070030	5910004	5940101	5940001	5930001

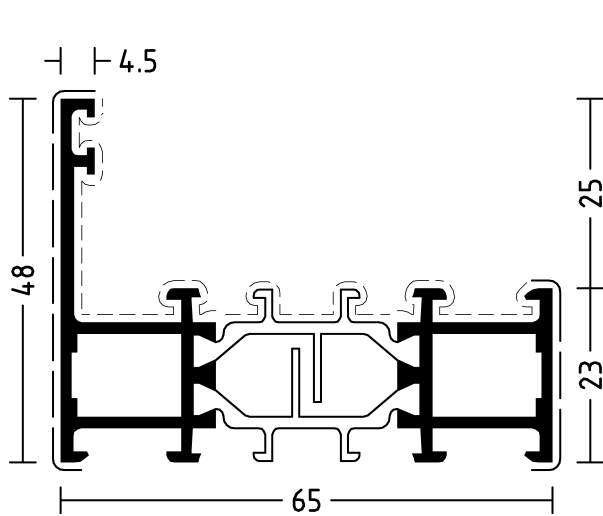

1916001

Gelenkeckwinkel und Gelenkverbinder siehe Zusatzartikel
See additional articles for hinged corner angles and hinged connectors.

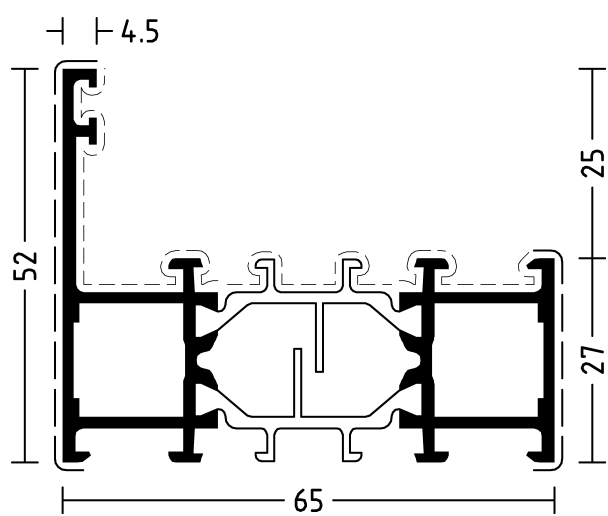

1916002

Gelenkeckwinkel und Gelenkverbinder siehe Zusatzartikel
See additional articles for hinged corner angles and hinged connectors.

	m	mm	mm										
	1916003	6,5	299	170	4950008	2x4070000	1x4960004	1x4070000	1x4070030	5910004	5940101	5940001	5930001
					4950008	2x4070000	1x4960004	1x4070000	1x4070030	5910004	5940101	5940001	5930001
	1916004	6,5	319	105	4950009	2x4070000	1x4960005	1x4070000	1x4070030	5910004	5940101	5940001	5930001
					4950009	2x4070000	1x4960005	1x4070000	1x4070030	5910004	5940101	5940001	5930001

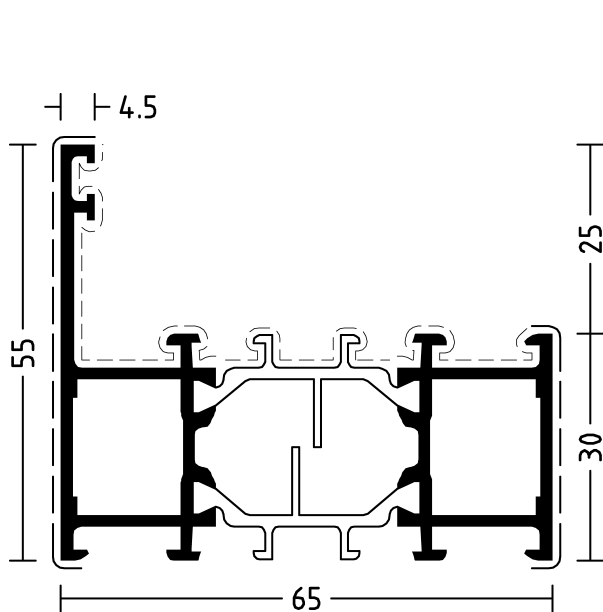





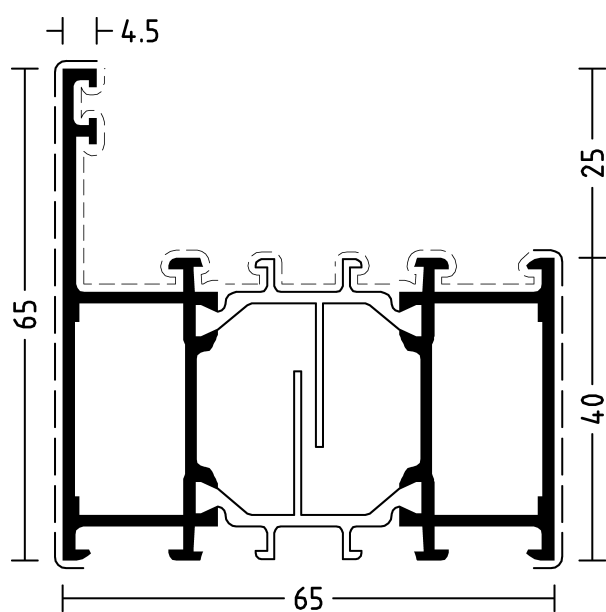







1916003

Gelenkeckwinkel und Gelenkverbinder siehe Zusatzartikel
See additional articles for hinged corner angles and hinged connectors.



1916004

Gelenkeckwinkel und Gelenkverbinder siehe Zusatzartikel
See additional articles for hinged corner angles and hinged connectors.

	m	mm	mm										
 1916005	6,5	339	125	4950010	2x4070000	1x4960006	1x4070000	1x4070030	5910004	5940101	5940001	5930001	
				4950010	2x4070000	1x4960006	1x4070000	1x4070030	5910004	5940101	5940001	5930001	
1916009	6,5	356	91	4950012	2x4070000	1x4960004	1x4070000	1x4070030	5910013	5940101	5940001	5930003	
				4950008	2x4070000	1x4960004	1x4070000	1x4070030	5910013	5940101	5940001	5930003	
1916019	6,5	302	77	4950008	2x4070000	1x4960004	1x4070000	1x4070030	5910014	-	5940001	-	
				4950008	2x4070000	1x4960004	1x4070000	1x4070030	5910014	-	5940001	-	

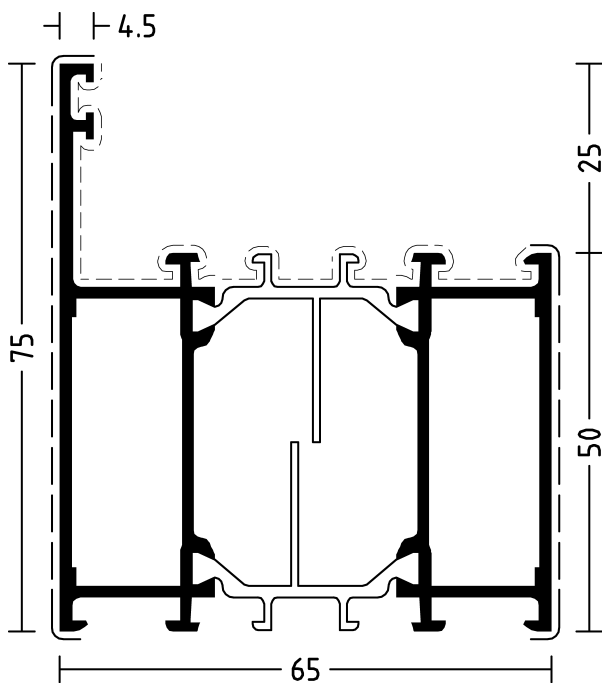

1916005

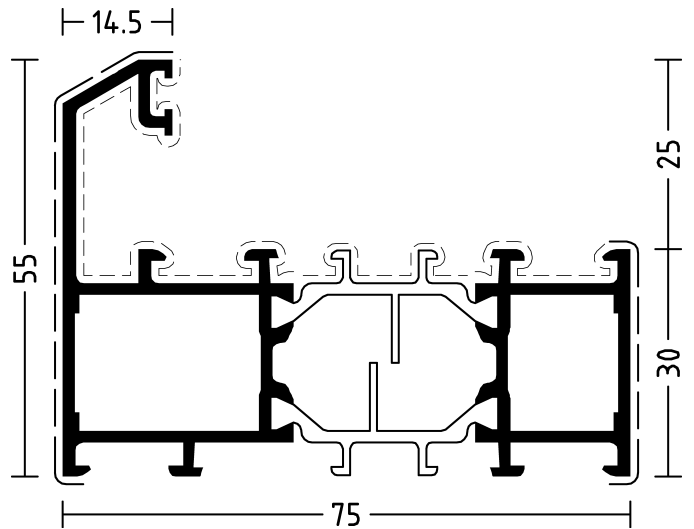

1916009

Blendrahmen Klassik-Design
Frame Classic design

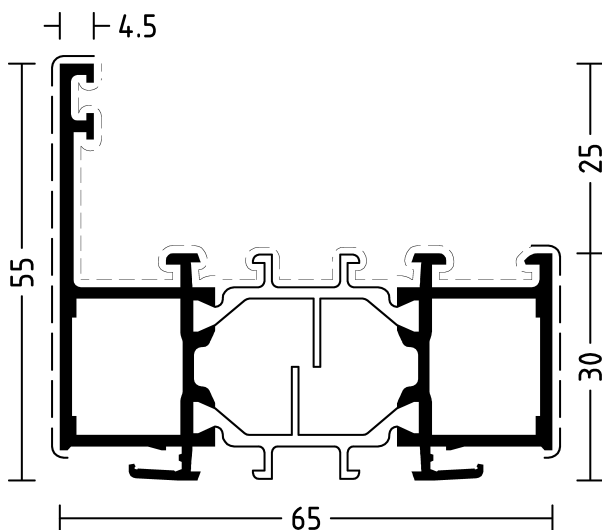

1916019

	m	mm	mm										
	1916055	6,5	222	46	4950006	2x4070000	1x4960002	1x4070000	-	5910004	5940101	5940001	5930001
					4950006	2x4070000	1x4960002	1x4070000	-	5910004	5940101	5940001	5930001
	1916056	6,5	230	54	4950007	2x4070000	1x4960003	1x4070000	1x4070030	5910004	5940101	5940001	5930001
					4950007	2x4070000	1x4960003	1x4070000	1x4070030	5910004	5940101	5940001	5930001
	1916057	6,5	236	60	4950008	2x4070000	1x4960004	1x4070000	1x4070030	5910004	5940101	5940001	5930001
					4950008	2x4070000	1x4960004	1x4070000	1x4070030	5910004	5940101	5940001	5930001

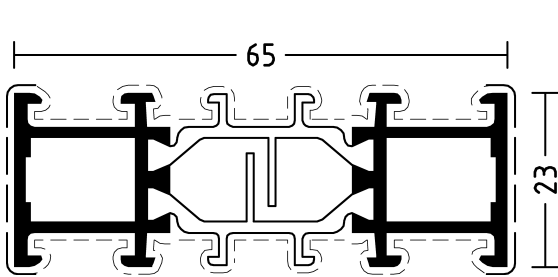



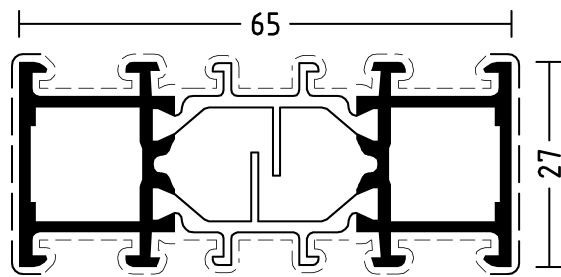



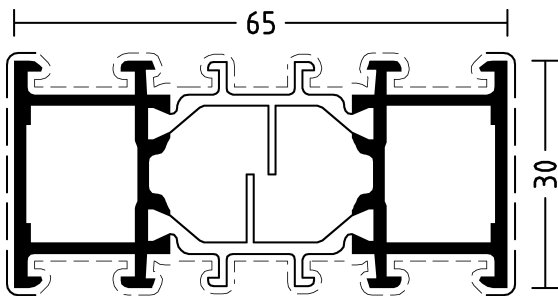







1916055



1916056



1916057

	 m	 mm	 mm									
 1916058	6,5	256	80	4950009	2x4070000	1x4960005	1x4070000	1x4070030	5910004	5940101	5940001	5930001
				4950009	2x4070000	1x4960005	1x4070000	1x4070030	5910004	5940101	5940001	5930001
1916059	6,5	276	100	4950010	2x4070000	1x4960006	1x4070000	1x4070030	5910004	5940101	5940001	5930001
				4950010	2x4070000	1x4960006	1x4070000	1x4070030	5910004	5940101	5940001	5930001
1916060	6,5	316	140	-	-	1x4960008	2x4070000	2x4070030	5910004	5940101	5940001	5930001
				-	-	1x4960008	2x4070000	2x4070030	5910004	5940101	5940001	5930001

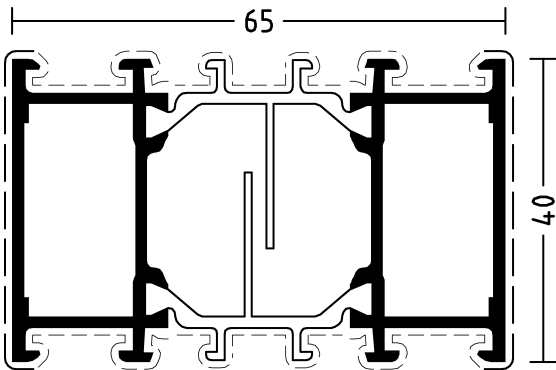

1916058

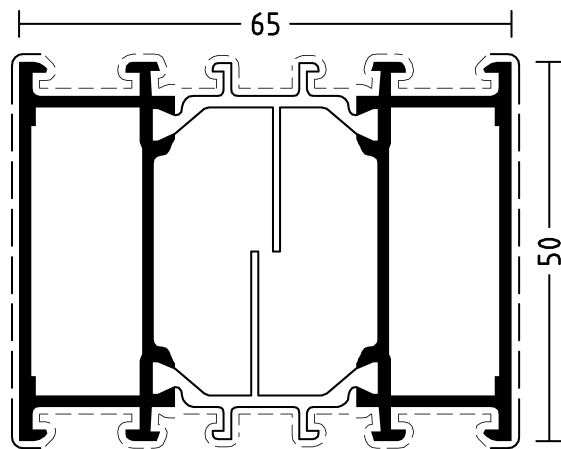



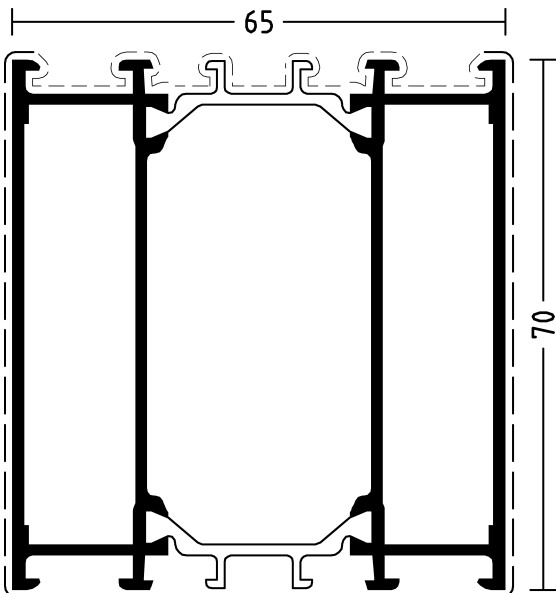







1916059



1916060

Eckverbindung außen: Zuschnitt aus 3900040 oder 3900053 (13.20)
 + 2x 4070000 Eckverbindung innen: Zuschnitt aus 3900040 oder
 3900053 (13.20) + 2x 4070000
 Corner connection outside: Cutting with 3900040 or 3900053 (13.20)
 + 2x 4070000 Corner connection inside: Cutting with 3900040 or
 3900053 (13.20) + 2x 4070000

												
	m	mm	mm									
 1916062	6,5	330	85	4950005	2x4070009	-	-	-	5910004	-	-	5930001
 1916064	6,5	350	105	4950005	2x4070009	-	-	-	5910004	-	-	5930001
				4950008	2x4070000	1x4960004	1x4070000	1x4070030	5910004	5940101	5940001	5930001
				4950008	2x4070000	1x4960004	1x4070000	1x4070030	5910004	5940101	5940001	5930001

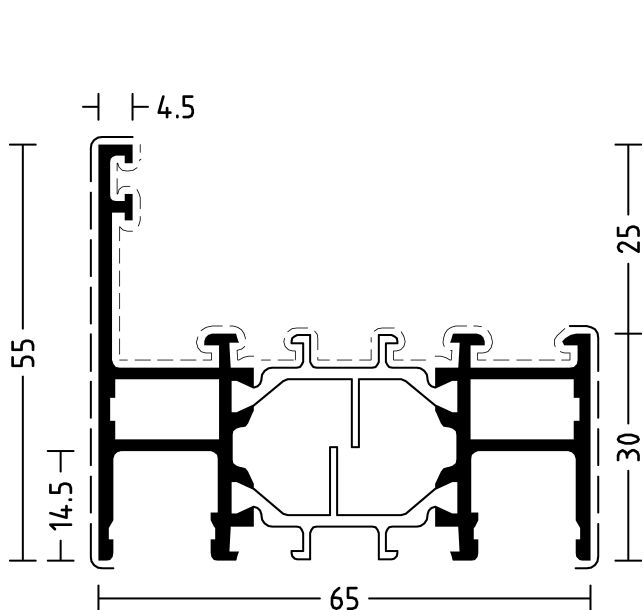



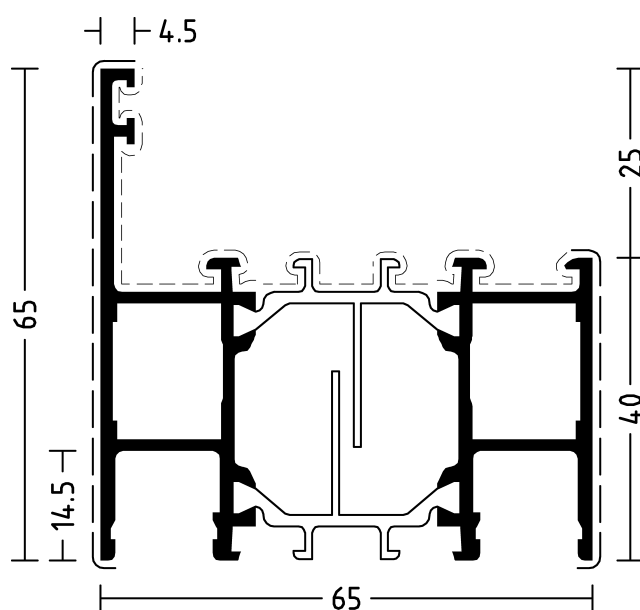

1916062

Gelenckwinkel und Gelenkverbinder siehe Zusatzartikel
See additional articles for hinged corner angles and hinged connectors.

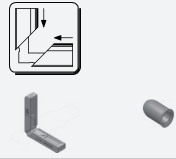

1916064

Gelenckwinkel und Gelenkverbinder siehe Zusatzartikel
See additional articles for hinged corner angles and hinged connectors.

	m	mm	mm									
 1916067	6,5	410	165	4950011	2x4070000	1x4960007	2x4070000	2x4070030	5910004	5940101	5940001	5930001
 1916068	6,5	347	96	4950011	2x4070000	1x4960007	2x4070000	2x4070030	5910004	5940101	5940001	5930001
				4950006	2x4070000	1x4960002	1x4070000	-	5910004	5940101	5940001	5930001
				4950006	2x4070000	1x4960002	1x4070000	-	5910004	5940101	5940001	5930001

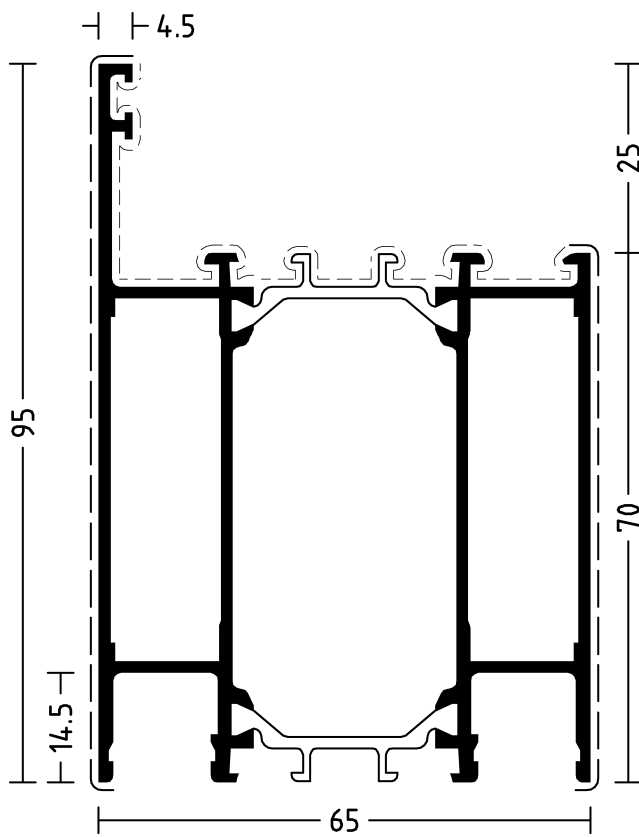

1916067

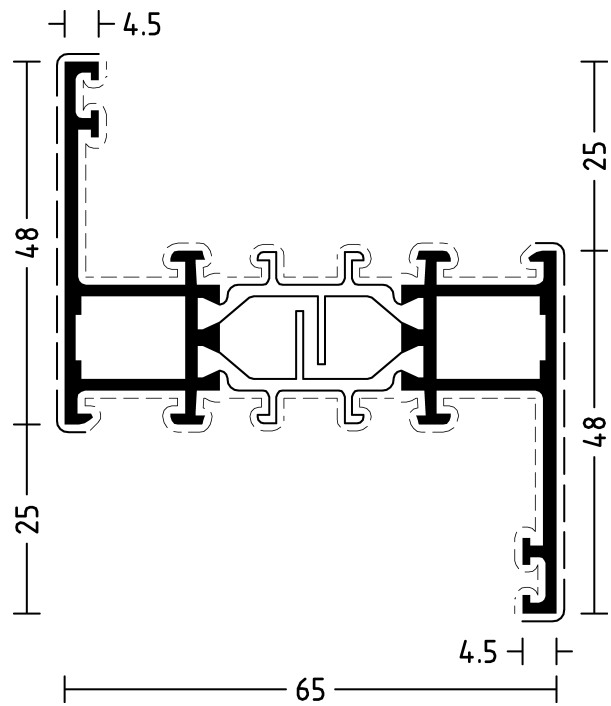

1916068

Gelenckwinkler und Gelenkverbinder siehe Zusatzartikel
See additional articles for hinged corner angles and hinged connectors.

	m	mm	mm									
1916069	6,5	361	110	4950008	2x4070000	1x4960004	1x4070000	1x4070030	5910004	5940101	5940001	5930001
				4950008	2x4070000	1x4960004	1x4070000	1x4070030	5910004	5940101	5940001	5930001
1916073	6,5	361	110	4950008	2x4070000	1x4960004	1x4070000	1x4070030	5910004	5940101	5940001	5930001
				4950008	2x4070000	1x4960004	1x4070000	1x4070030	5910004	5940101	5940001	5930001

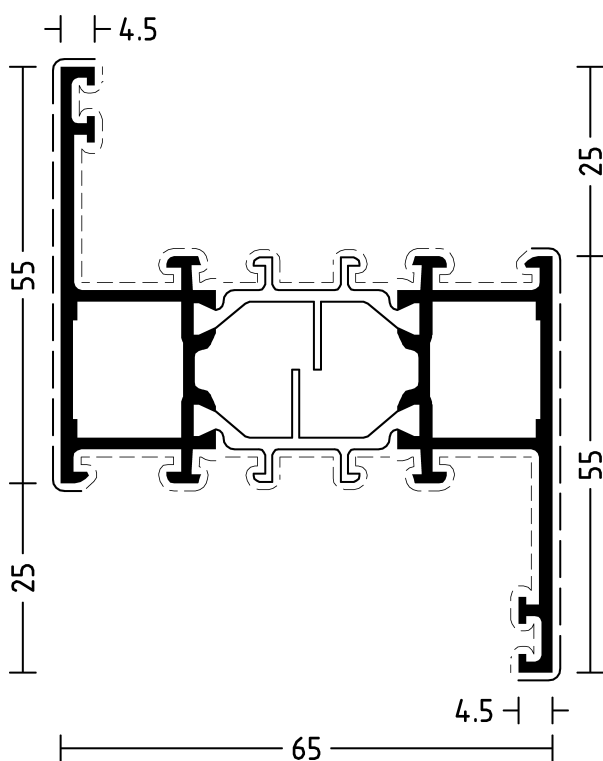

1916069

Gelenkeckwinkel und Gelenkverbinder siehe Zusatzartikel
See additional articles for hinged corner angles and hinged connectors.

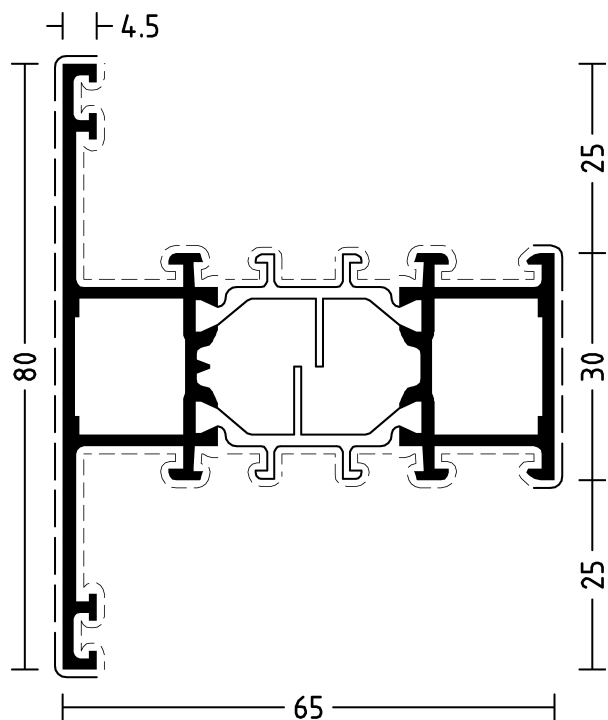

1916073

Gelenkeckwinkel und Gelenkverbinder siehe Zusatzartikel
See additional articles for hinged corner angles and hinged connectors.

	m	mm	mm										
	1916076	6,5	303	70	4950013	2x4070008	-	-	-	5910016	5940107	5940010	5930008
					4950006	2x4070008	-	-	-	5910016	5940101	5940010	5930008
	1916077	6,5	317	84	4950014	2x4070008	-	-	-	5910016	5940107	5940010	5930008
					4950008	2x4070008	-	-	-	5910016	5940101	5940010	5930008

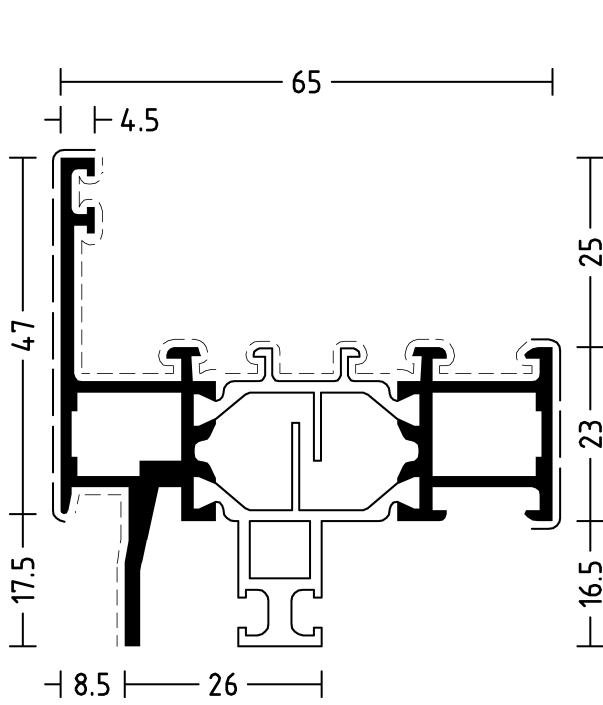





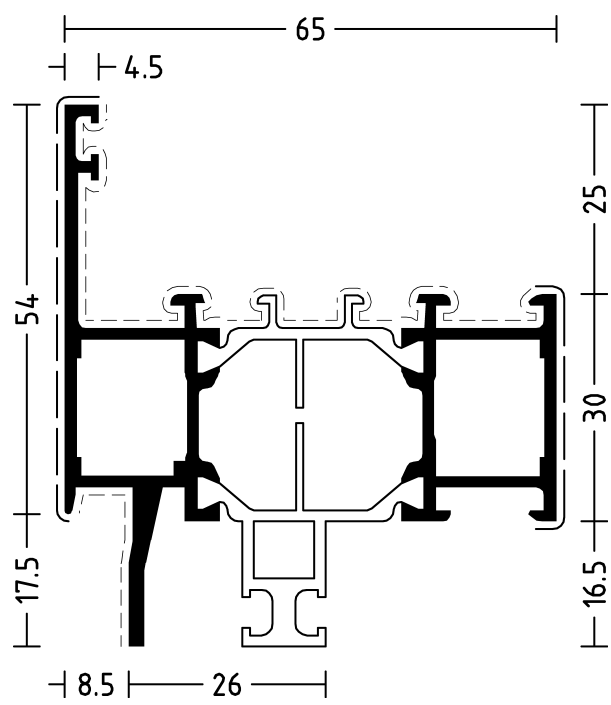









1916076

Einspannblendrahmen
Clamping frame profile



1916077

Einspannblendrahmen
Clamping frame profile

												
	m	mm	mm									
 1926500	6,5	298	100	4950008	2x4070000	-	-	-	5910004	5940101	5940001	5930001
				4950008	2x4070000	-	-	-	5910004	5940101	5940001	5930001
1926501	6,5	326	128	4950015	2x4070000	-	-	-	5910004	5940101	5940001	5930001
				4950015	2x4070000	-	-	-	5910004	5940101	5940001	5930001
1926502	6,5	338	140	4950010	2x4070000	-	-	-	5910004	5940101	5940001	5930001
				4950010	2x4070000	-	-	-	5910004	5940101	5940001	5930001

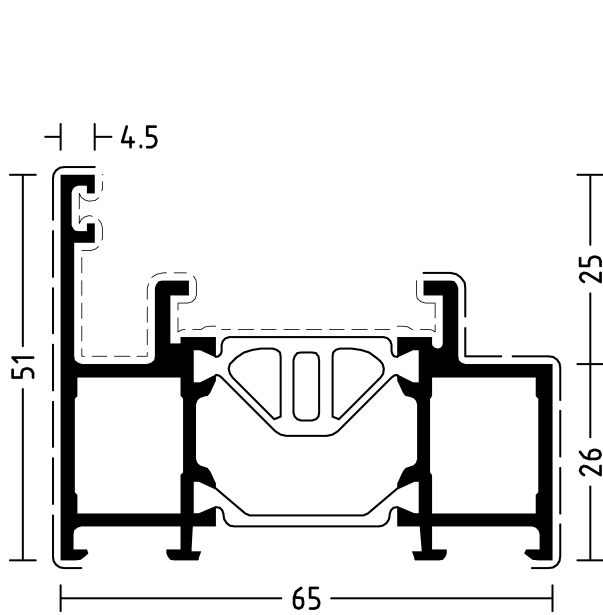



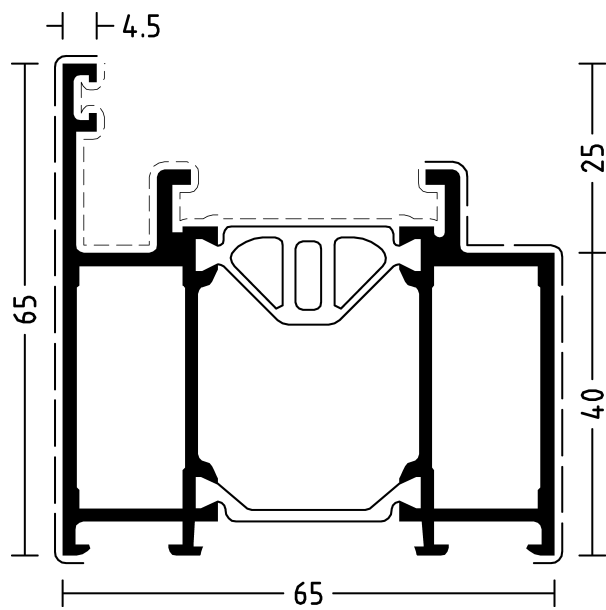



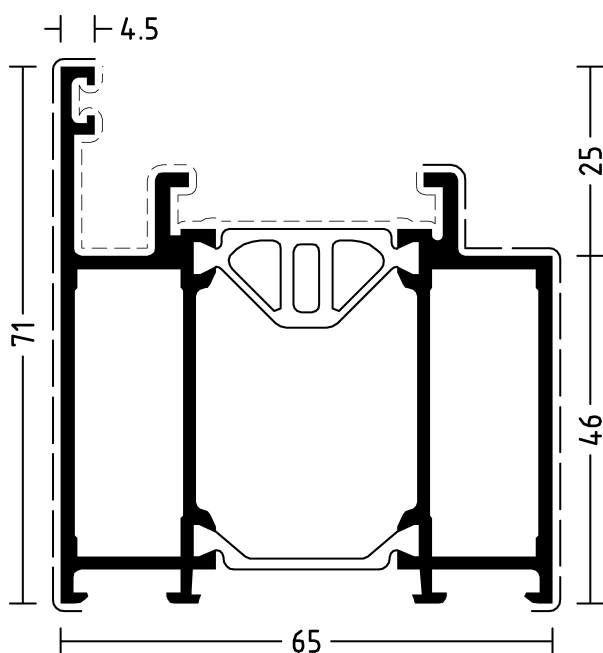





1926500



1926501



1926502

	m	mm	mm										
 1926503	6,5	341	139	4950010	2x4070000	-	-	-	5910004	5940101	5940001	5930001	
				4950010	2x4070000	-	-	-	5910004	5940101	5940001	5930001	
1020499	6,5	342	144	4950058	2x4070000	-	-	-	5910019	5940110	5940049	5930001	
				4950058	2x4070000	-	-	-	5910019	5940110	5940049	5930001	
1926504	6,5	302	92	4950008	2x4070000	-	-	-	5910014	-	5940001	-	
				4950008	2x4070000	-	-	-	5910014	-	5940001	-	

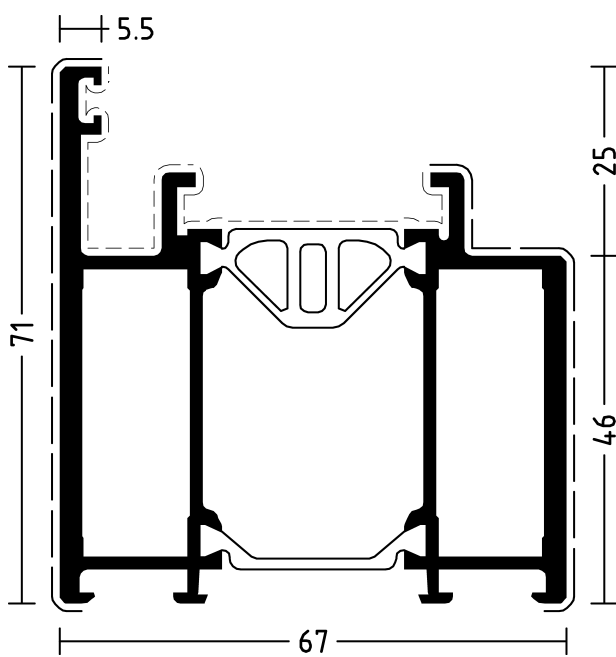

1926503



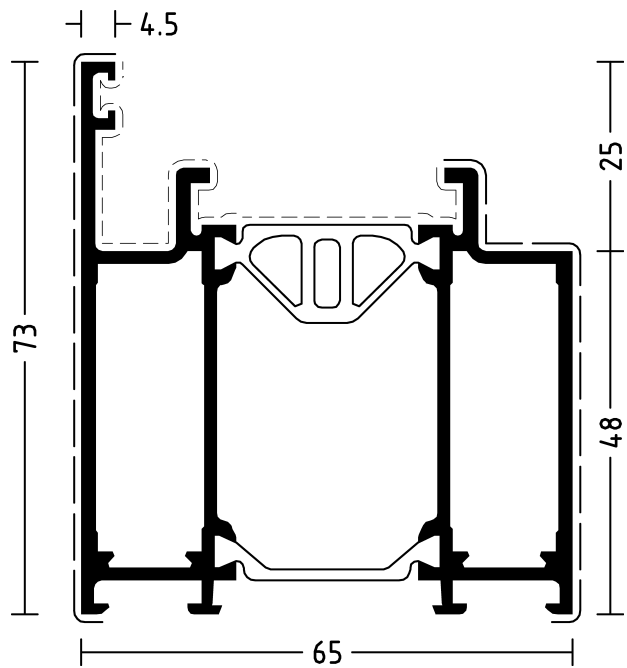



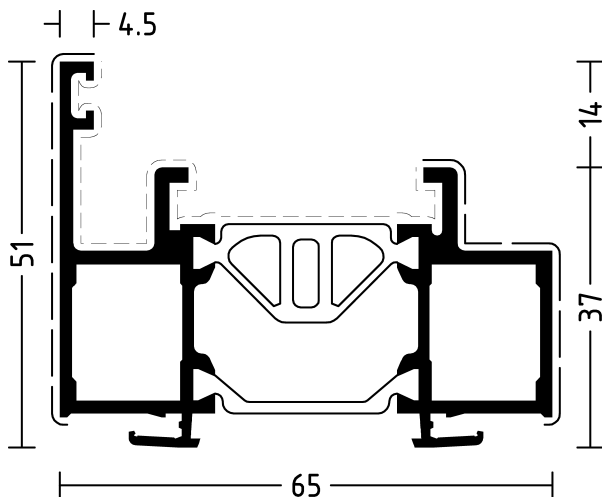



verstärkt ein- und auswärts öffnend
reinforced, in- and outward opening



1020499







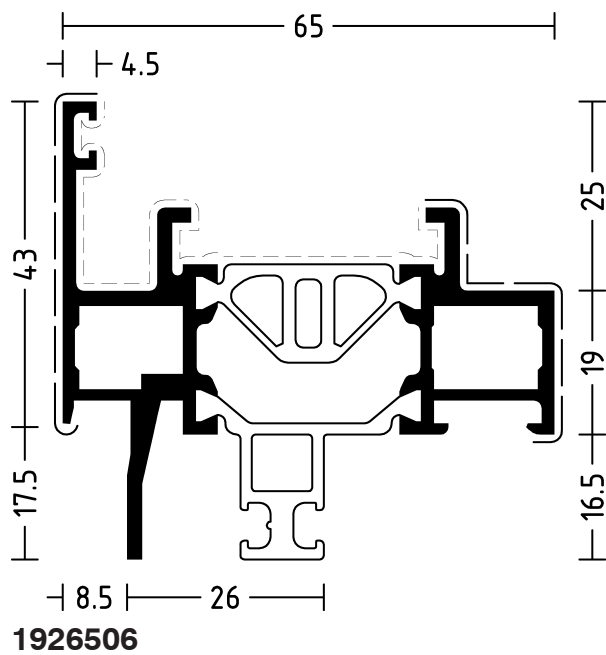
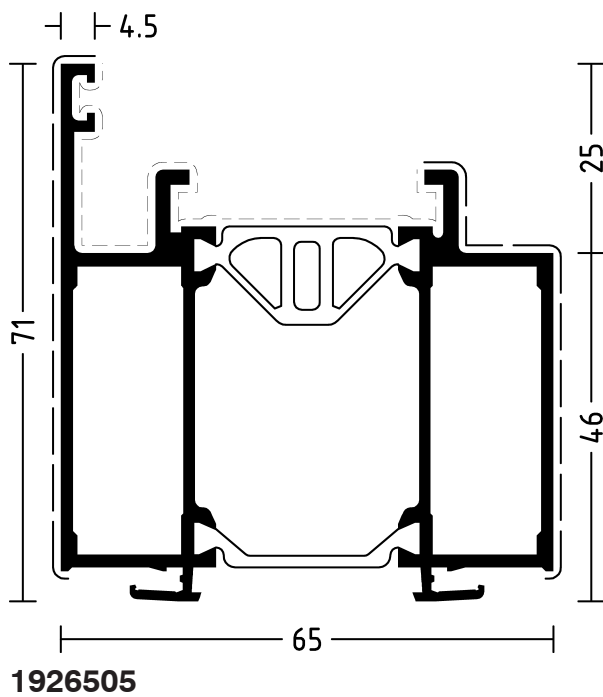









1926504

	m	mm	mm									
 1926505	6,5	342	131	4950010	2x4070000	-	-	-	5910014	-	5940001	-
 1926506	6,5	303	85	4950010	2x4070000	-	-	-	5910014	-	5940001	-
				4950013	2x4070008	-	-	-	5910016	5940107	5940010	5930008
				4950006	2x4070008	-	-	-	5910016	5940101	5940010	5930008



Einspannblendrahmen für Fassade/Rollenband
einwärts öffnend
Clamping frame for façade/butt hinge
inward opening

												
	m	mm	mm									
 1926507	6,5	303	85	4950013	2x4070008	-	-	-	5910016	5940107	5940010	5930008
				4950006	2x4070008	-	-	-	5910016	5940101	5940010	5930008
1926541	6,5	313	74	4950008	2x4070000	-	-	-	5910004	5940101	5940001	5930001
				4950008	2x4070000	-	-	-	5910004	5940101	5940001	5930001

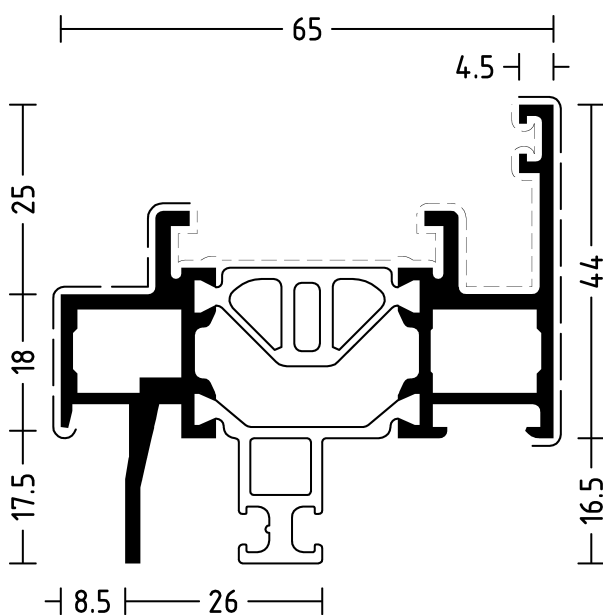





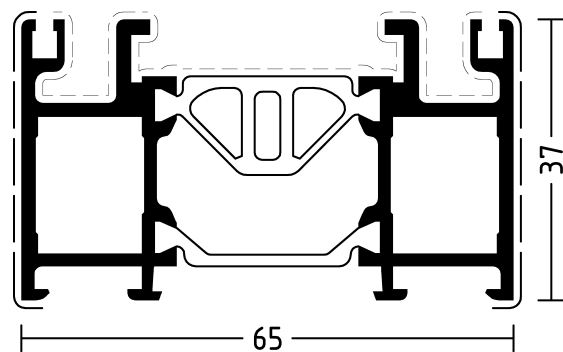









1926507

Einspannblendrahmen für Fassade/Rollenband
auswärts öffnend
Clamping frame for façade/butt hinge
outward opening



1926541

Spezialblendrahmen für Pendeltüren
Special frame profile for double action doors

												
	m	mm	mm									
 1926542	6,5	353	114	4950010	2x4070000	-	-	-	5910004	5940101	5940001	5930001
				4950010	2x4070000	-	-	-	5910004	5940101	5940001	5930001
1926544	6,5	326	151	-	-	1x4960201	2x4070000	2x4070030	5910019	-	-	-
				-	-	1x4960201	2x4070000	2x4070030	5910019	-	-	-

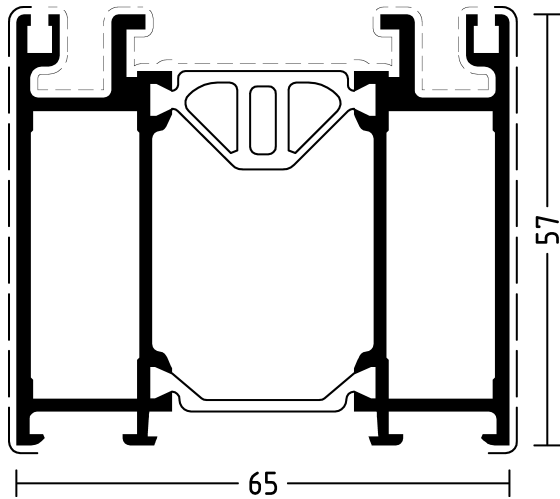

1926542

Spezialblendrahmen für Pendeltüren
Special frame profile for double action doors

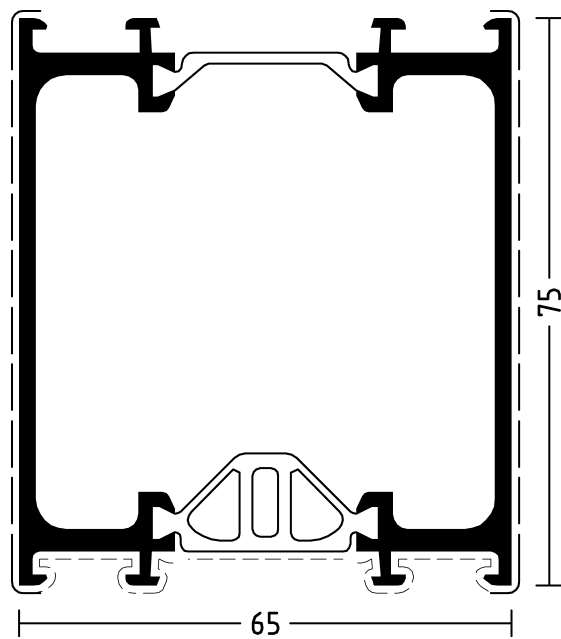















1926544









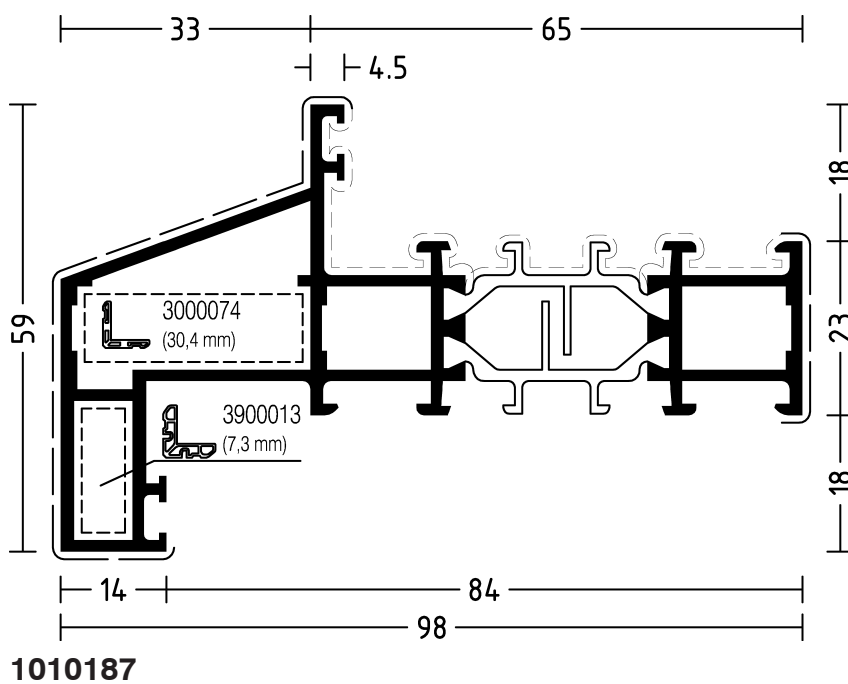





Blendrahmen für integrierten Türschließer
Frame profile for integrated door closer

WICSTYLE 65 evo / 65

Blendrahmenprofile Frame profiles

												
	m	mm	mm									
 1010187	6,5	387	119	4950006	2x4070000	1x4960035	1x4070000	-	5910004	5940101	5940001	5930001
				4950006	2x4070000	1x4960002	1x4070000	-	5910004	5940101	5940001	5930001



												
	m	mm	mm									
 1926516	6,5	433	189	-	-	1x4960064	2x4070000	2x4070030	5910004	5940101	5940001	-
 1926517	6,5	453	209	-	-	1x4960014	2x4070000	2x4070030	5910004	5940101	5940001	-
				-	-	1x4960065	2x4070000	2x4070030	5910004	5940101	5940001	-
				-	-	1x4960015	2x4070000	2x4070030	5910004	5940101	5940001	-

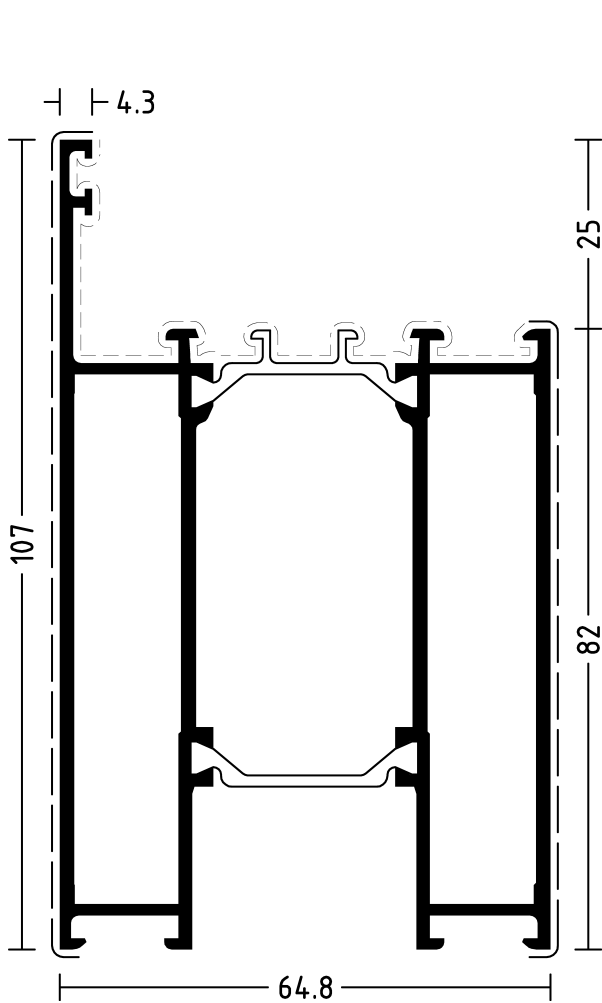

1926516

Stoßverbindungen mit Blendrahmenprofilen (Festfeld) Verbinder 4960014 (außen).

Butt joint connections with frame profiles (fixed field), connector 4960014 (outside).

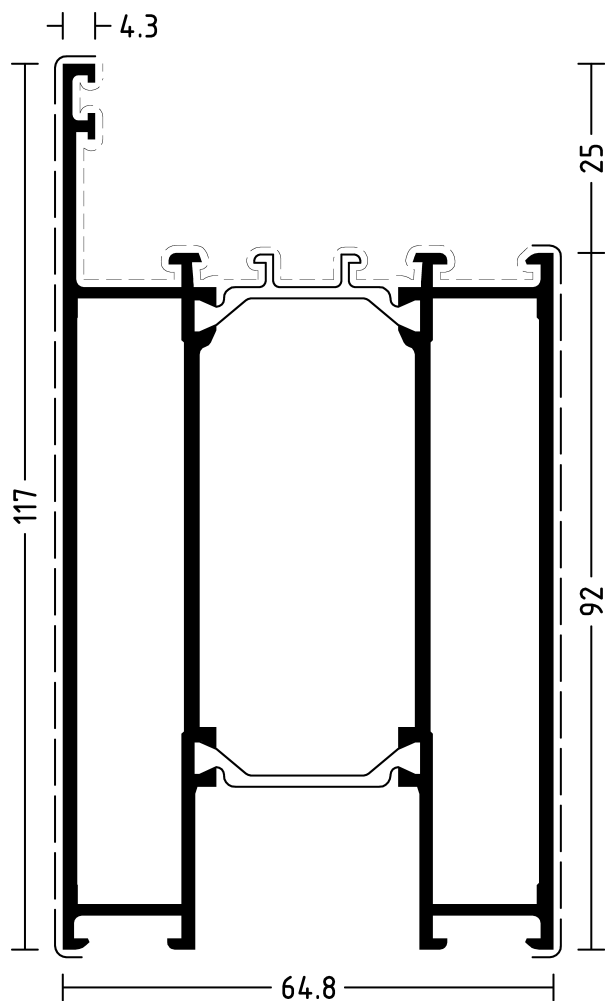















1926517

Stoßverbindungen mit Blendrahmenprofilen (Festfeld) Verbinder 4960015 (außen).

Butt joint connections with frame profiles (fixed field), connector 4960015 (outside).

WICSTYLE 65 evo / 65

Sockelprofile
Bottom rail profiles

												
	m	mm	mm									
 1926518	6,5	513	269	-	-	1x4960066	2x4070000	2x4070030	5910004	5940101	5940001	-
				-	-	1x4960016	2x4070000	2x4070030	5910004	5940101	5940001	-

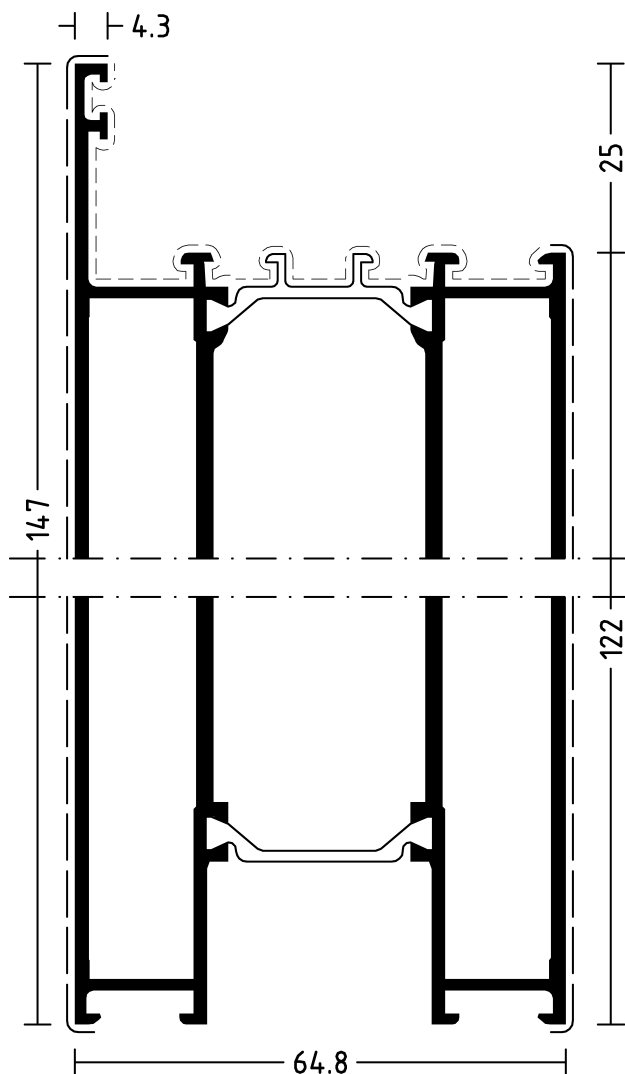

1926518

Stoßverbindungen mit Blendrahmenprofilen (Festfeld) Verbinder 4960016 (außen).

Butt joint connections with frame profiles (fixed field), connector 4960016 (outside).



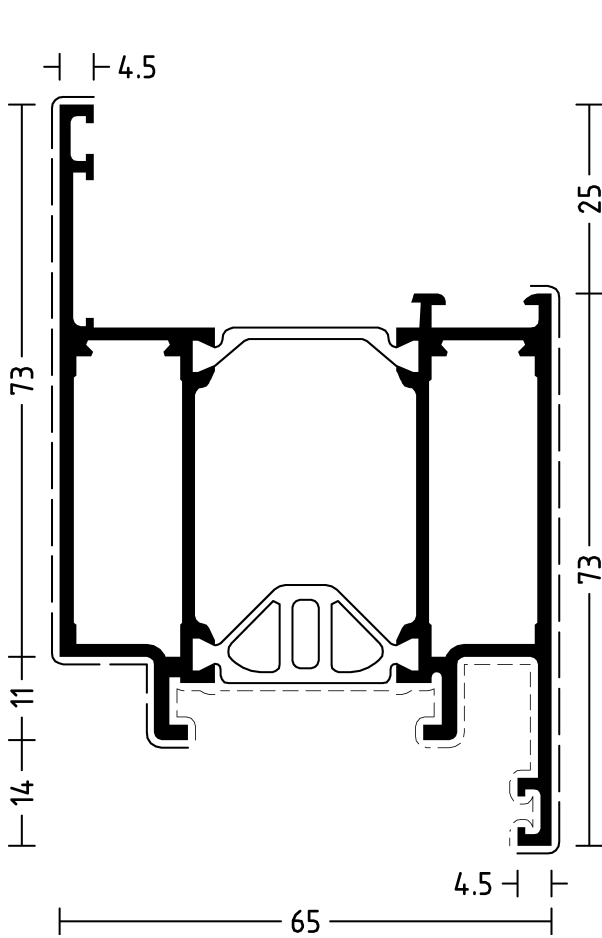



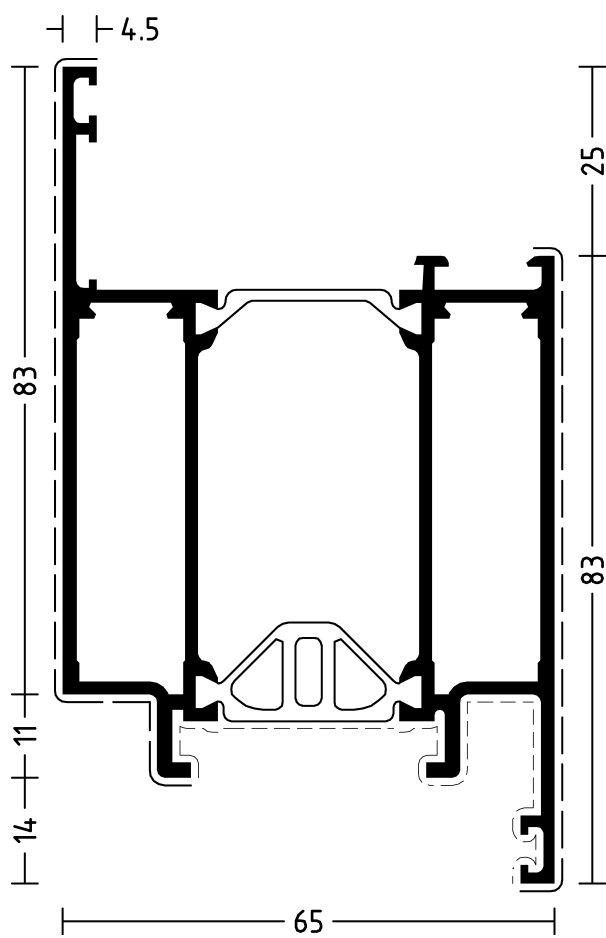



	m	mm	mm									
1926510	6,5	394	169	4950058	2x4070000	-	-	-	5910023	5940112	5940049	5930001
				4950058	2x4070000	-	-	-	5910023	5940112	5940049	5930001
1926511	6,5	414	189	4950059	2x4070000	-	-	-	5910023	5940112	5940049	5930001
				4950059	2x4070000	-	-	-	5910023	5940112	5940049	5930001



1926510
nach innen öffnend
inward opening



1926511
nach innen öffnend
inward opening

	m	mm	mm									
 1926512	6,5	444	219	4950016	2x4070000	-	-	-	5910023	5940112	5940049	5930001
				4950016	2x4070000	-	-	-	5910023	5940112	5940049	5930001
1926513	6,5	394	169	4950058	2x4070000	-	-	-	5910023	5940112	5940049	5930001
				4950058	2x4070000	-	-	-	5910023	5940112	5940049	5930001

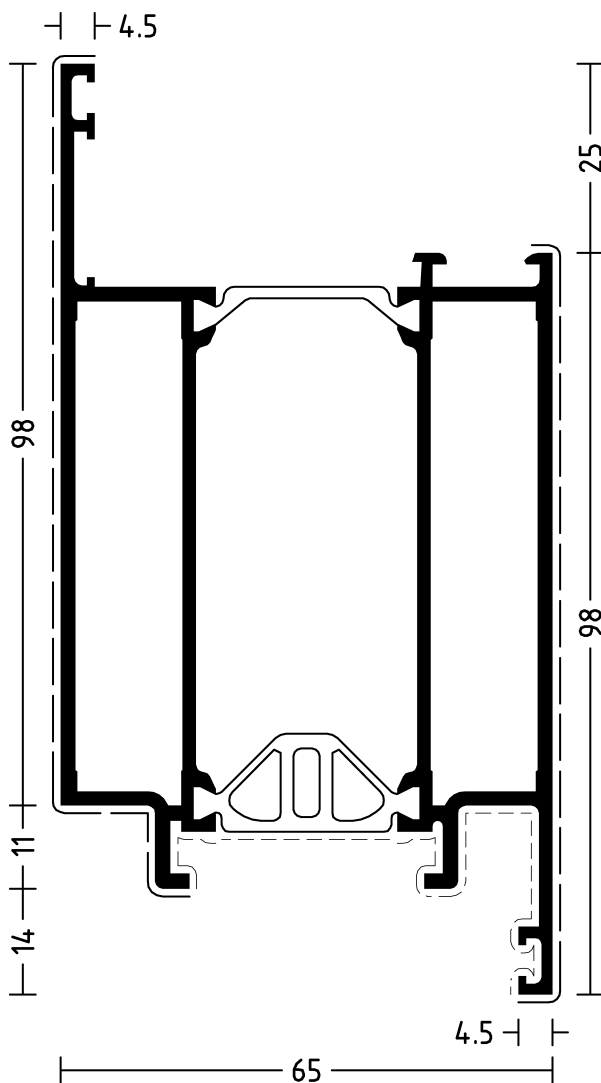



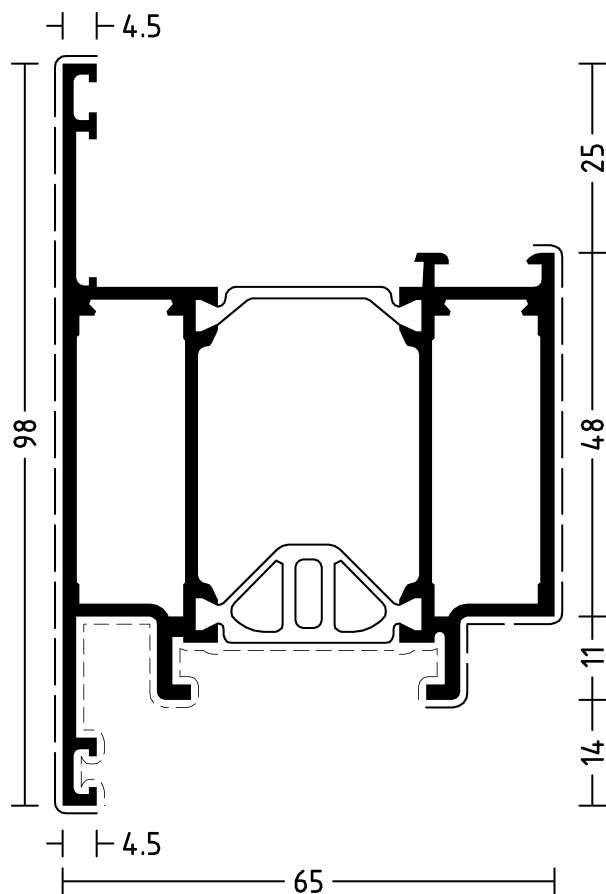







1926512
nach innen öffnend
inward opening



1926513
nach außen öffnend
outward opening

WICSTYLE 65 evo / 65

Flügelprofile Sash profiles



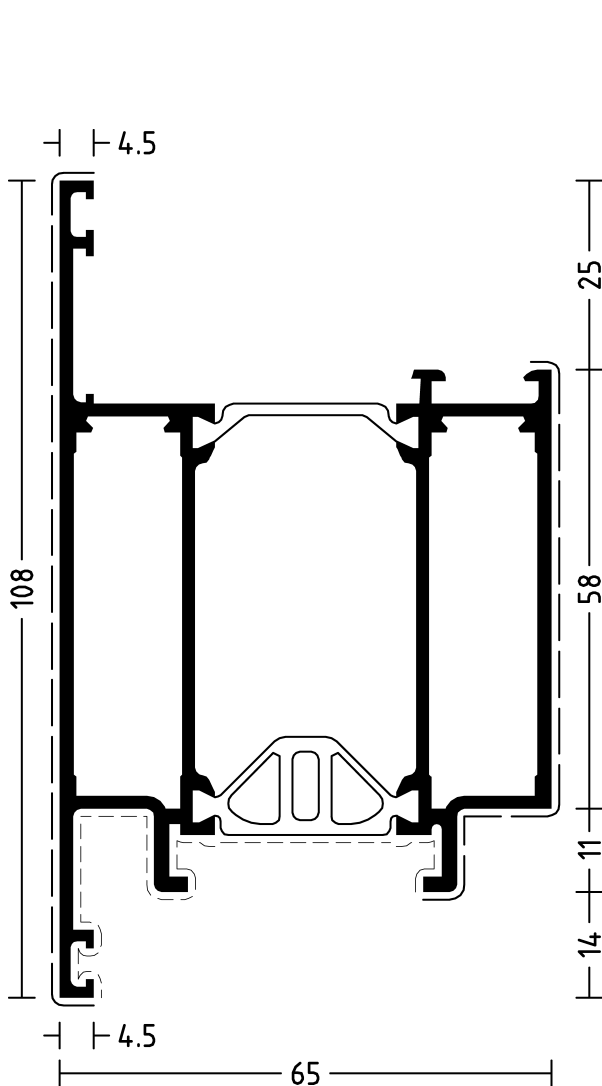



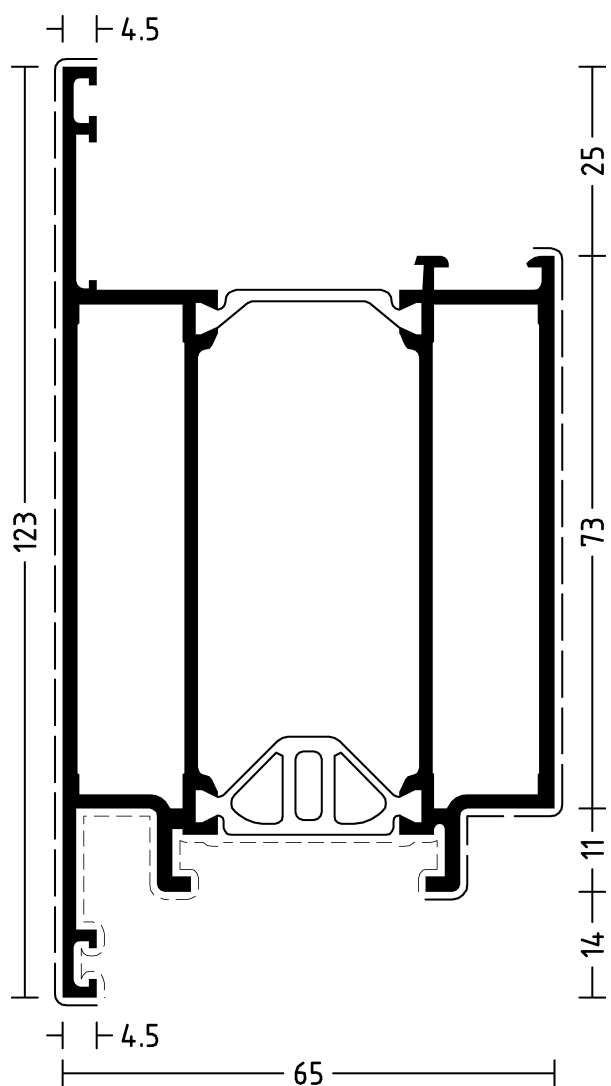







	m	mm	mm									
 1926514	6,5	414	189	4950059	2x4070000	-	-	-	5910023	5940112	5940049	5930001
 1926515	6,5	444	219	4950059	2x4070000	-	-	-	5910023	5940112	5940049	5930001
				4950016	2x4070000	-	-	-	5910023	5940112	5940049	5930001
				4950016	2x4070000	-	-	-	5910023	5940112	5940049	5930001



1926514
nach außen öffnend
outward opening



1926515
nach außen öffnend
outward opening

												
	m	mm	mm									
 1926534	6,5	466	168	4950058	2x4070000	1x4960056	1x4070000	1x4070030	5910023	5940112	5940049	5930001
				4950058	2x4070000	1x4960006	1x4070000	1x4070030	5910023	5940112	5940049	5930001
1926535	6,5	397	167	4950058	2x4070000	-	-	-	5910023	5940112	5940049	5930001
				4950058	2x4070000	-	-	-	5910023	5940112	5940049	5930001

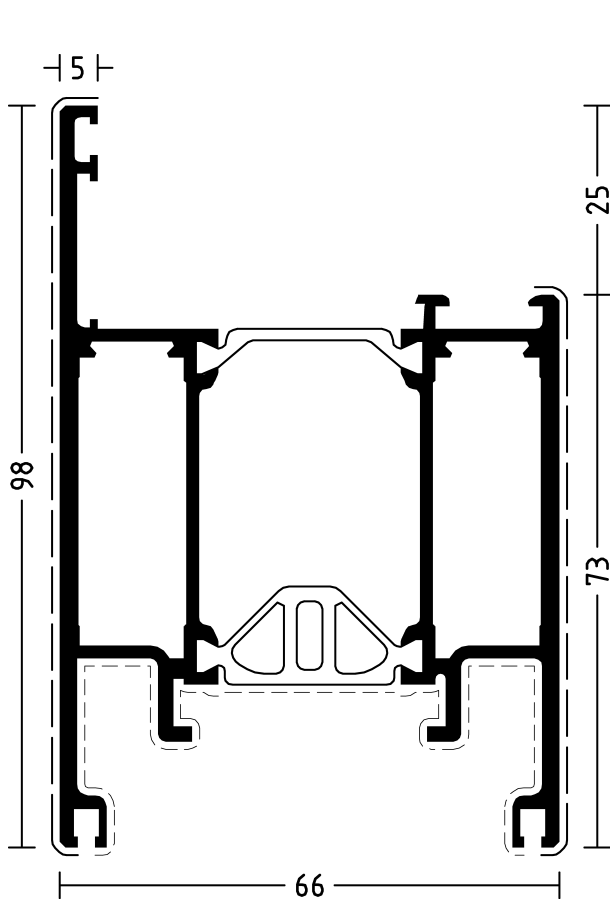





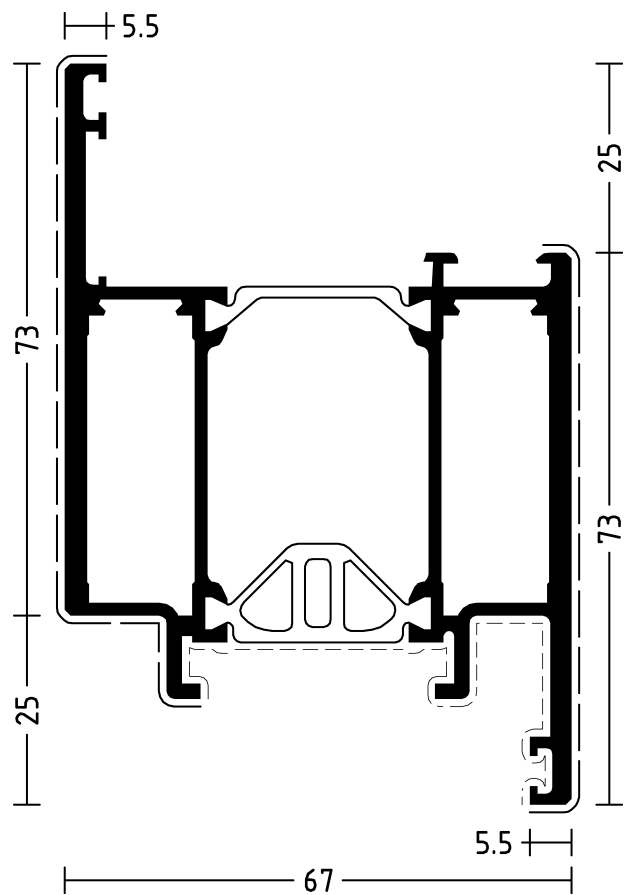





1926534

Flügelprofil für Pendeltüren, verstärkt
Leaf profile for double action doors, reinforced



1926535

Flügelprofil, verstärkt
nach innen öffnend
Leaf profile, reinforced
inward opening

	m	mm	mm									
 1926536	6,5	397	168	4950058	2x4070000	-	-	-	5910023	5940112	5940049	5930001
				4950058	2x4070000	-	-	-	5910023	5940112	5940049	5930001
1926540	6,5	465	171	4950058	2x4070000	1x4960056	1x4070000	1x4070030	5910023	5940112	5940049	5930001
				4950058	2x4070000	1x4960006	1x4070000	1x4070030	5910023	5940112	5940049	5930001

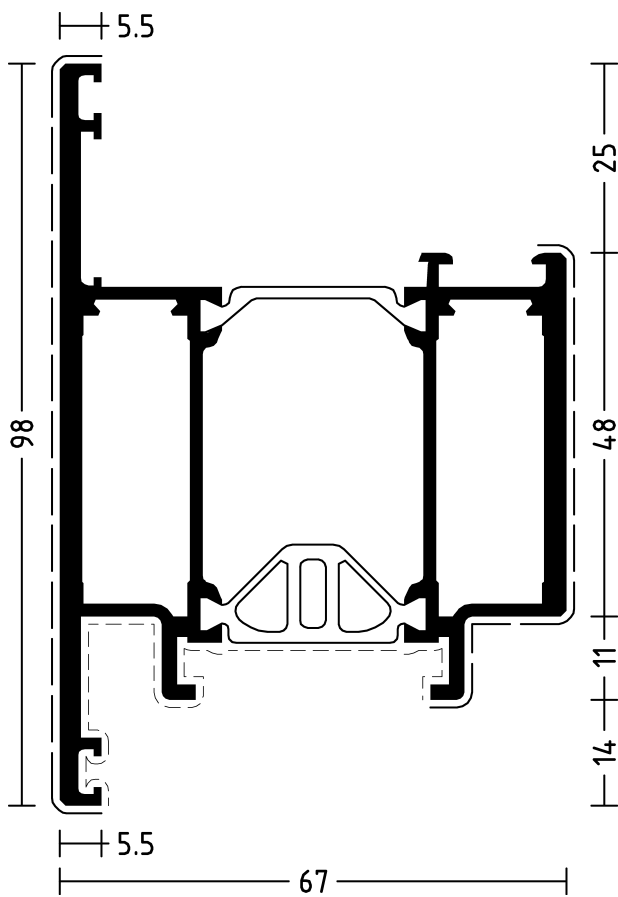





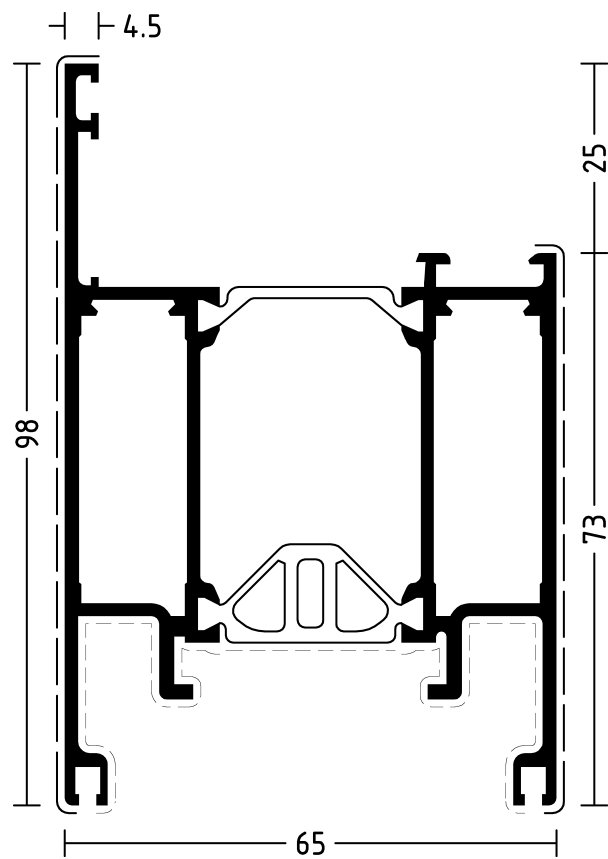









1926536

Flügelprofil, verstärkt
nach außen öffnend
*Leaf profile, reinforced
outward opening*



1926540

Flügelprofil für Pendeltüren
Leaf profile for double action doors

												
	m	mm	mm									
 1920512	6,5	241	0	4950328	2x4070000	-	-	-	5910076	5940107	-	5930030
				4950328	2x4070000	-	-	-	5910076	5940107	-	5930030
1920516	6,5	333	83	4950328	2x4070000	-	-	-	5910076	5940107	-	5930030
				4950059	2x4070000	-	-	-	5910076	5940112	-	5930030

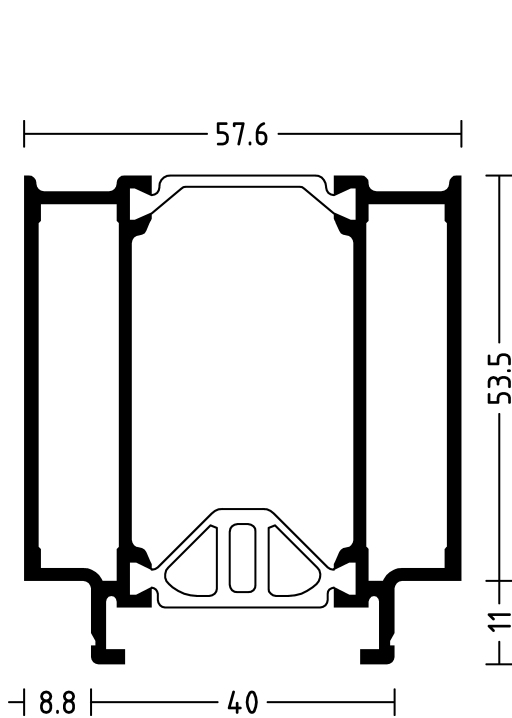





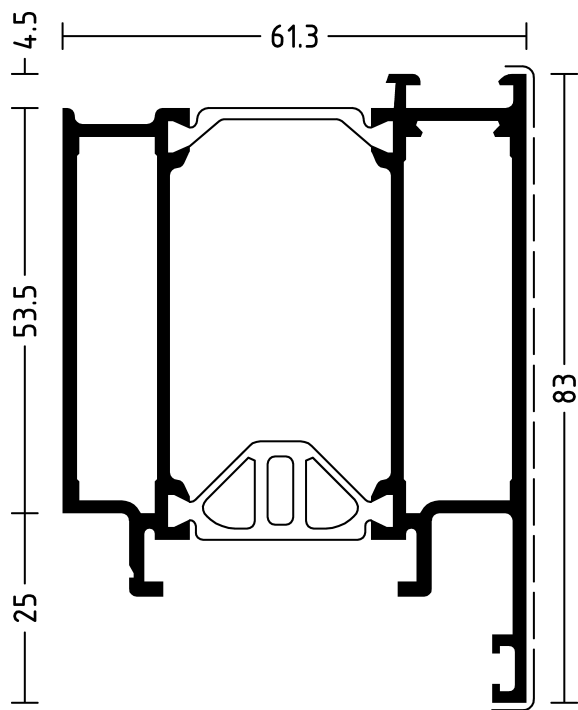









1920512

Für beidseitig fÜgelüberdeckende FÜllung.
For both-sided leaf overlapping infill.









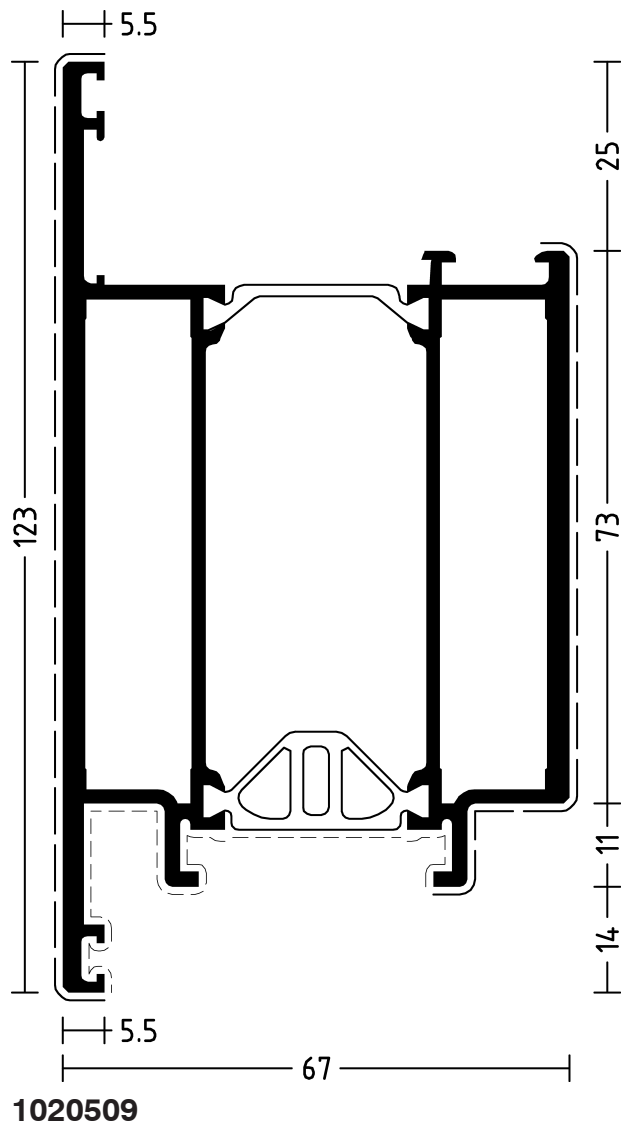
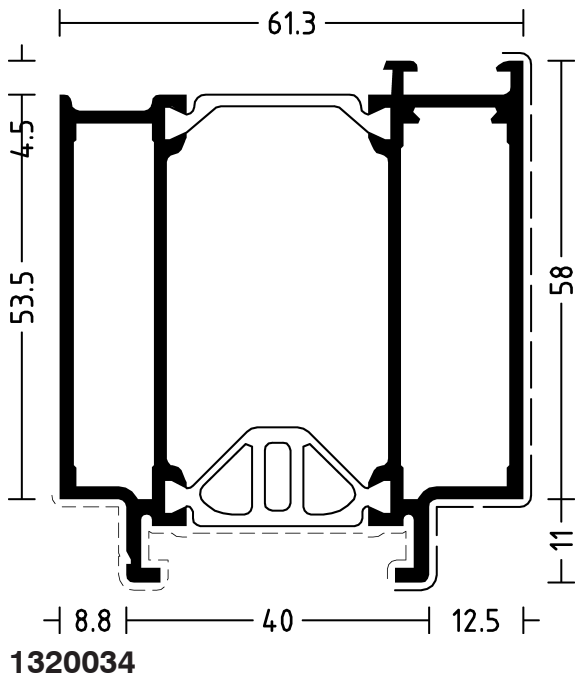







1920516

Für einseitig fÜgelüberdeckende FÜllung.
For single-sided leaf overlapping infill.

	 m	 mm	 mm									
 1320034	6,5	270	81	4950328	2x4070000	-	-	-	5910076	5940107	-	5930030
 1020509	6,5	447	217	4950059	2x4070000	-	-	-	5910076	5940112	-	5930030
				4950016	2x4070000	-	-	-	5910023	5940112	5940049	5930001
				4950016	2x4070000	-	-	-	5910023	5940112	5940049	5930001



												
	m	mm	mm									
 1916201	6,5	345	96	4950006	2x4070000	1x4960002	1x4070000	-	5910004	5940101	5940001	5930001
				4950006	2x4070000	1x4960002	1x4070000	-	5910004	5940101	5940001	5930001
1916202	6,5	353	104	4950007	2x4070000	1x4960003	1x4070000	1x4070030	5910004	5940101	5940001	5930001
				4950007	2x4070000	1x4960003	1x4070000	1x4070030	5910004	5940101	5940001	5930001

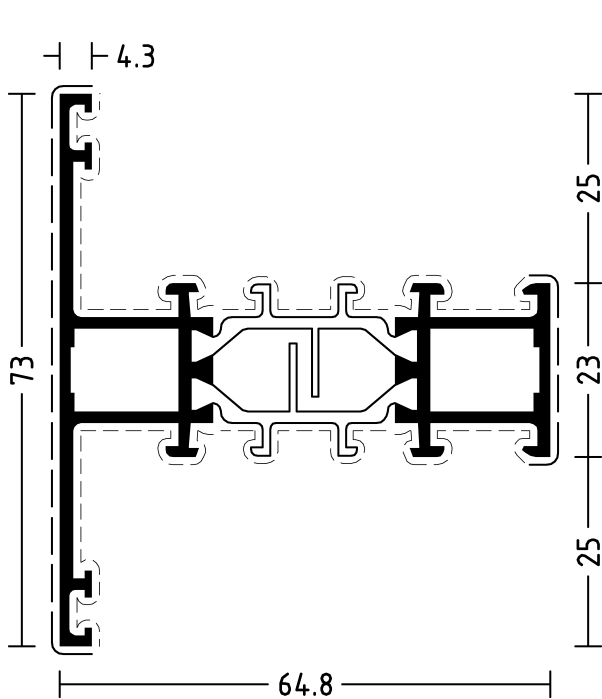





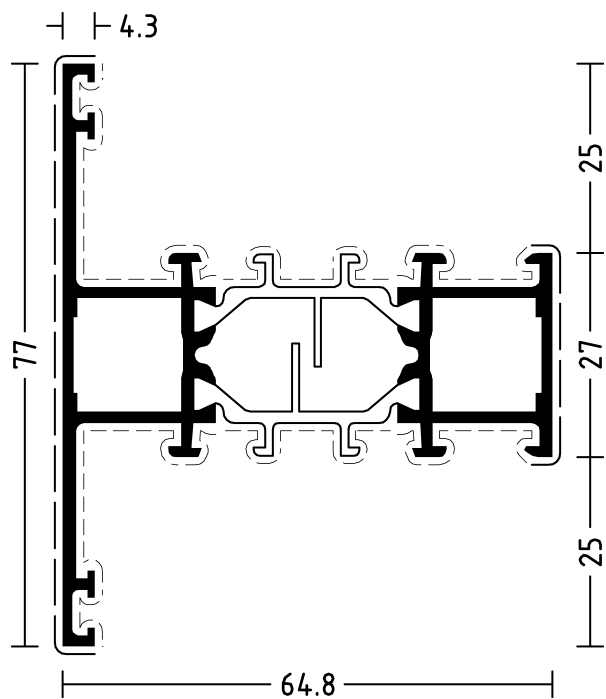





1916201

Gelenkeckwinkel und Gelenkverbinder siehe Zusatzartikel.
 Stoßverbindungen mit Tür-Flügelprofilen WICSTYLE 65 Verbinder 4960052 (außen).
 See additional articles for hinged corner angles and hinged connectors.
 Butt joint connections with WICSTYLE 65 door leaf profiles, connector 4960052 (outside).



1916202

Gelenkeckwinkel und Gelenkverbinder siehe Zusatzartikel.
 Stoßverbindungen mit Tür-Flügelprofilen WICSTYLE 65 Verbinder 4960053 (außen).
 See additional articles for hinged corner angles and hinged connectors.
 Butt joint connections with WICSTYLE 65 door leaf profiles, connector 4960053 (outside).

	m	mm	mm									
 1916203	6,5	359	110	4950008	2x4070000	1x4960004	1x4070000	1x4070030	5910004	5940101	5940001	5930001
				4950008	2x4070000	1x4960004	1x4070000	1x4070030	5910004	5940101	5940001	5930001
1916204	6,5	379	130	4950009	2x4070000	1x4960005	1x4070000	1x4070030	5910004	5940101	5940001	5930001
				4950009	2x4070000	1x4960005	1x4070000	1x4070030	5910004	5940101	5940001	5930001

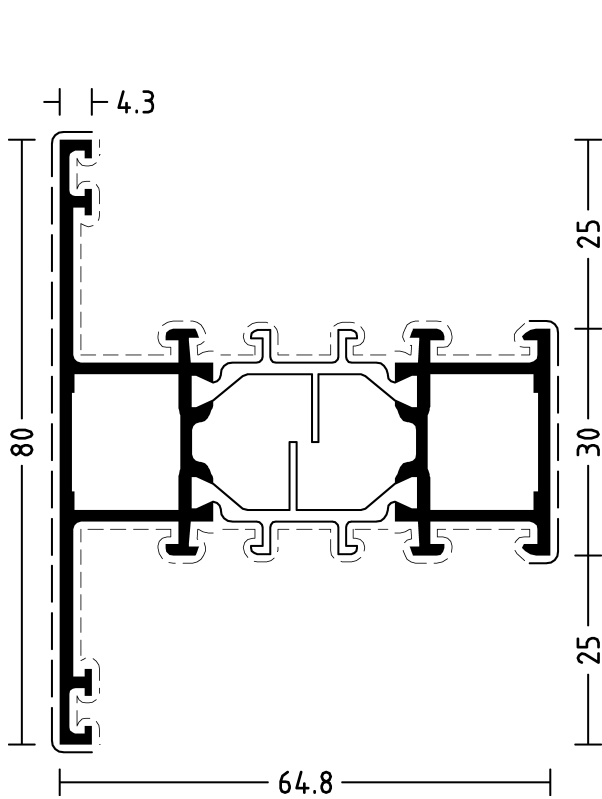

1916203

Gelenckwinkel und Gelenkverbinder siehe Zusatzartikel. Stoßverbindungen mit Tür-Flügelprofilen WICSTYLE 65 Verbinder 4960054 (außen). Stoßverbindungen mit Flügelprofilen WICSLIDE 160 Verbinder 4960026 (außen).

See additional articles for hinged corner angles and hinged connectors. Butt joint connections with WICSTYLE 65 door leaf profiles, connector 4960054 (outside). Butt joint connections with WICSLIDE 160 sash profiles, connector 4960026 (outside).

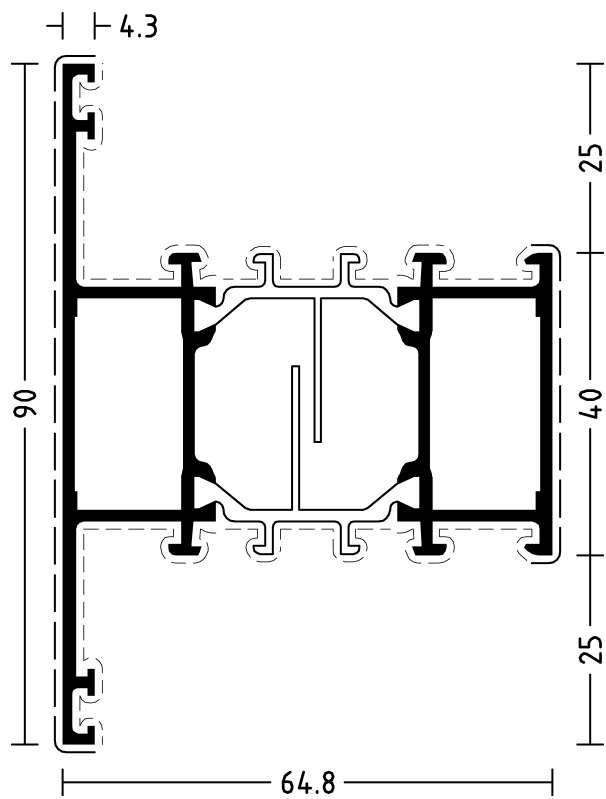

1916204

Gelenckwinkel und Gelenkverbinder siehe Zusatzartikel. Stoßverbindungen mit Tür-Flügelprofilen WICSTYLE 65 Verbinder 4960055 (außen).

See additional articles for hinged corner angles and hinged connectors.

Butt joint connections with WICSTYLE 65 door leaf profiles, connector 4960055 (outside).

	1916205	6,5	399	150	4950010	2x4070000	1x4960006	1x4070000	1x4070030	5910004	5940101	5940001	5930001
					4950010	2x4070000	1x4960006	1x4070000	1x4070030	5910004	5940101	5940001	5930001
	1916206	6,5	419	170	4950011	2x4070000	1x4960007	2x4070000	2x4070030	5910004	5940101	5940001	5930001
					4950011	2x4070000	1x4960007	2x4070000	2x4070030	5910004	5940101	5940001	5930001

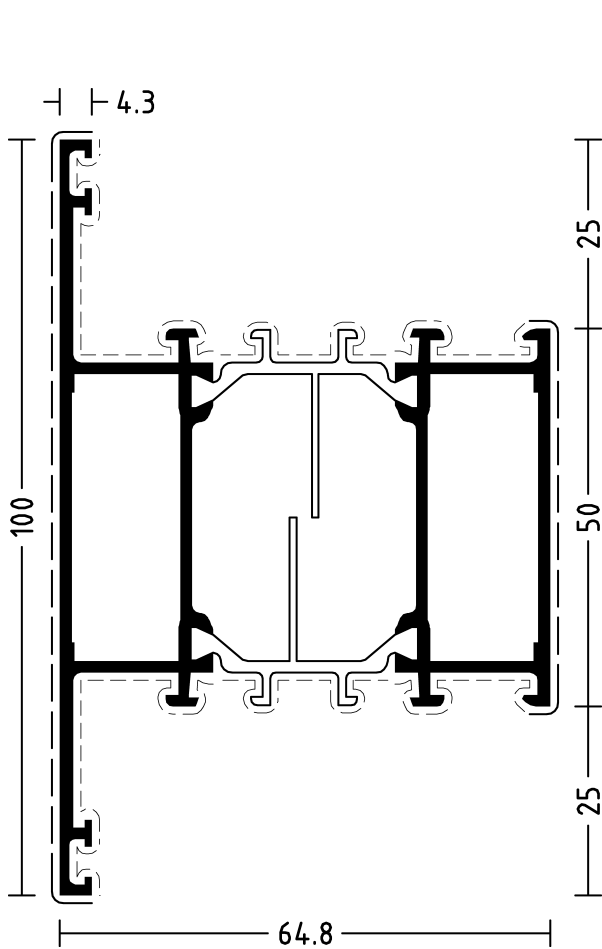

1916205

Stoßverbindungen mit Tür-Flügelprofilen WICSTYLE 65 Verbinder 4960056 (außen).



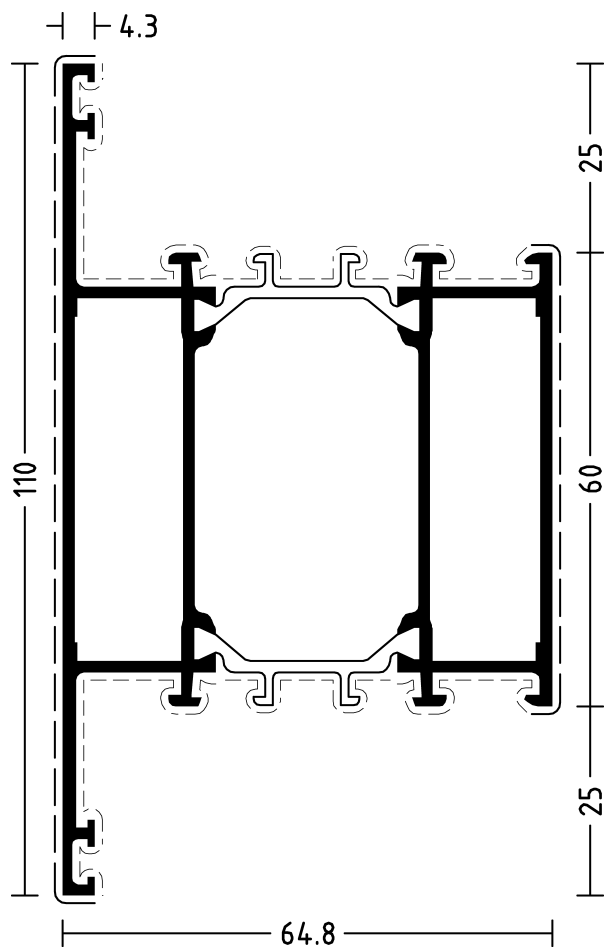







Butt joint connections with WICSTYLE 65 door leaf profiles, connector 4960056 (outside).



1916206

Stoßverbindungen mit Tür-Flügelprofilen WICSTYLE 65 Verbinder 4960057 (außen).

Butt joint connections with WICSTYLE 65 door leaf profiles, connector 4960057 (outside).

	m	mm	mm									
 1916207	6,5	439	190	-	-	1x4960008	2x4070000	2x4070030	5910004	5940101	5940001	5930001
 1916209	6,5	479	230	-	-	1x4960010	2x4070000	2x4070030	5910004	5940101	5940001	-
				-	-	1x4960010	2x4070000	2x4070030	5910004	5940101	5940001	-

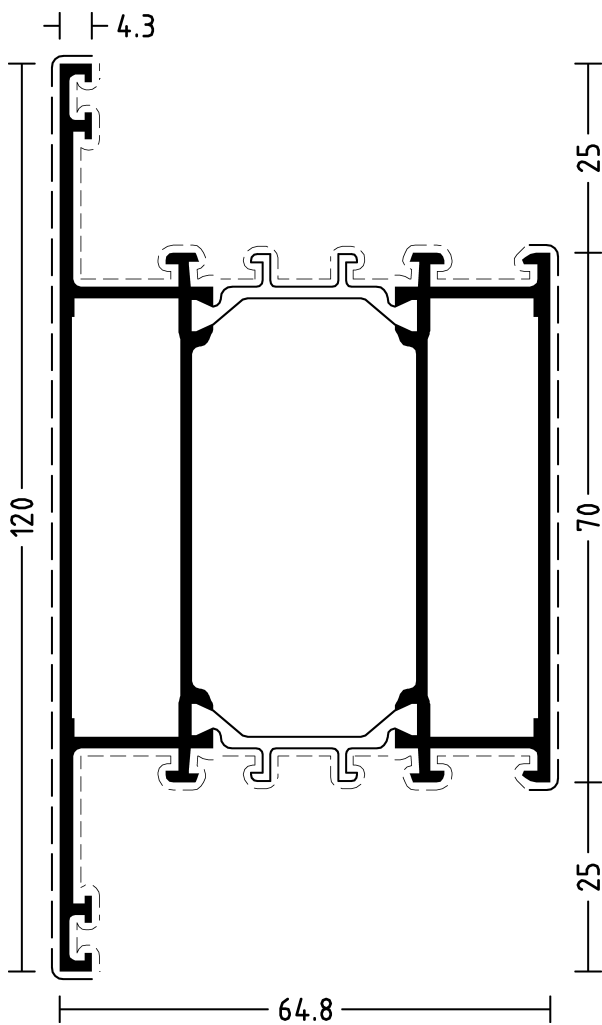

1916207

Eckverbindung außen/innen:
Zuschnitt aus 3900040 oder 3900053 (13.20) + 2x 4070000
Stoßverbindungen mit Tür-Flügelprofilen WICSTYLE 65 Verbinder 4960058 (außen).
Corner connection outside/inside:
Cutting with 3900040 or 3900053 (13.20) + 2x 4070000
Butt joint connections with WICSTYLE 65 door leaf profiles, connector 4960058 (outside).

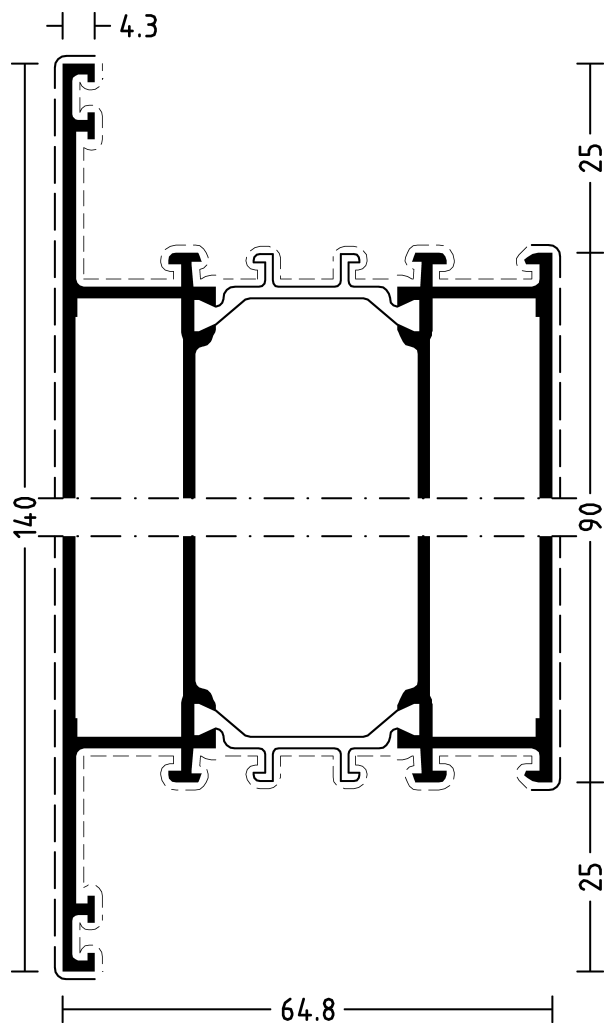











1916209

Stoßverbindungen mit Tür-Flügelprofilen WICSTYLE 65 Verbinder 4960060 (außen).
Butt joint connections with WICSTYLE 65 door leaf profiles, connector 4960060 (outside).

WICSTYLE 65 evo / 65

Kämpfer, Sprossenprofile
Transom, glazing bar profiles

	m	mm	mm									
 1916211	6,5	519	270	-	-	1x4960012	2x4070000	2x4070030	5910004	5940101	5940001	-
				-	-	1x4960012	2x4070000	2x4070030	5910004	5940101	5940001	-
1916213	6,5	559	310	-	-	2x4960008	2x4070000	2x4070030	5910004	5940101	5940001	-
				-	-	2x4960004	2x4070000	2x4070030	5910004	5940101	5940001	-

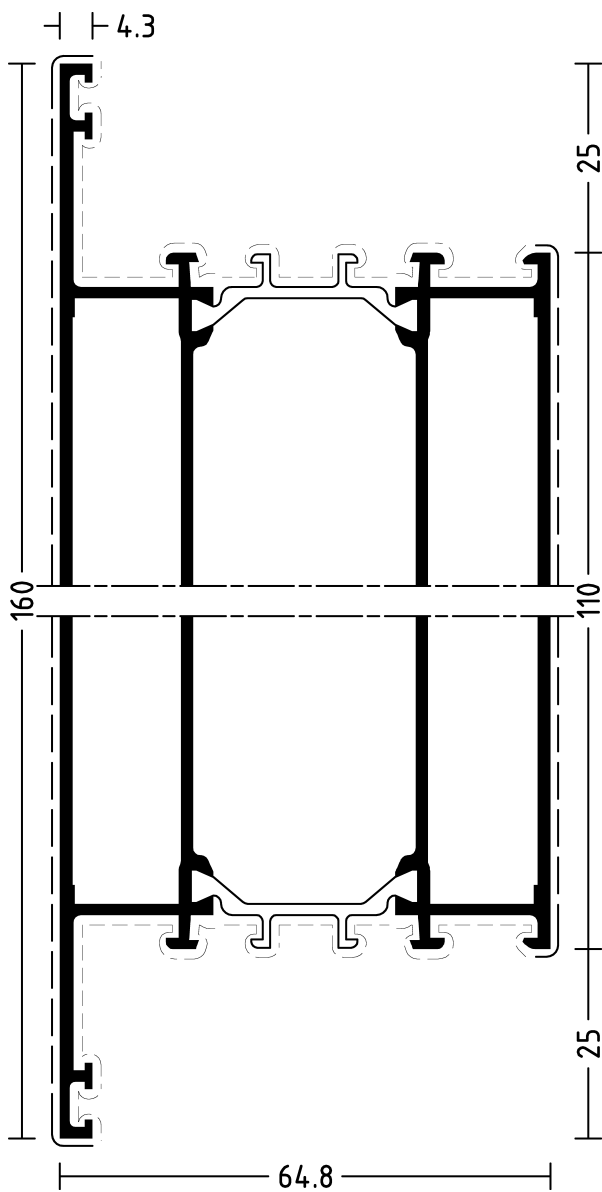

1916211

Stoßverbindungen mit Tür-Flügelprofilen WICSTYLE 65 Verbinder 4960062 (außen).
Butt joint connections with WICSTYLE 65 door leaf profiles, connector 4960062 (outside).

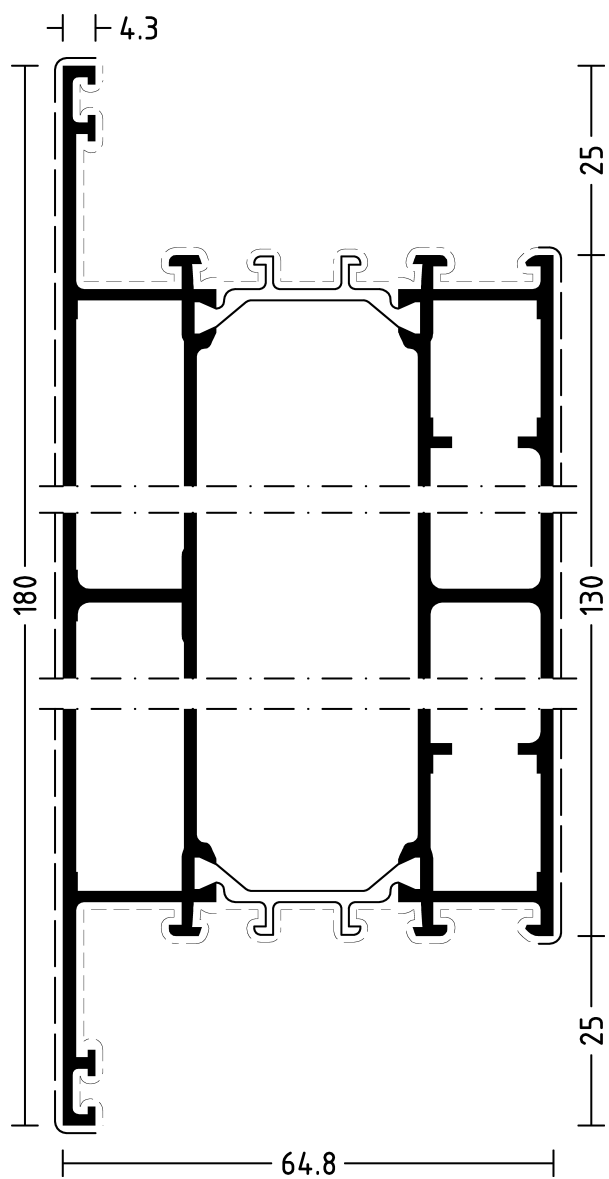















1916213

Stoßverbindungen mit Tür-Flügelprofilen WICSTYLE 65 Verbinder 4960058 (außen).
Butt joint connections with WICSTYLE 65 door leaf profiles, connector 4960058 (outside).

WICSTYLE 65 evo / 65

Kämpfer, Sprossenprofile
Transom, glazing bar profiles

												
	m	mm	mm									
 1916215	6,5	599	350	-	-	2x4960009	2x4070000	2x4070030	5910004	5940101	5940001	-
 1916220	6,5	699	450	-	-	2x4960004	2x4070000	2x4070030	5910004	5940101	5940001	-
				-	-	2x4960011	2x4070000	2x4070030	5910004	5940101	5940001	-
				-	-	2x4960004	2x4070000	2x4070030	5910004	5940101	5940001	-

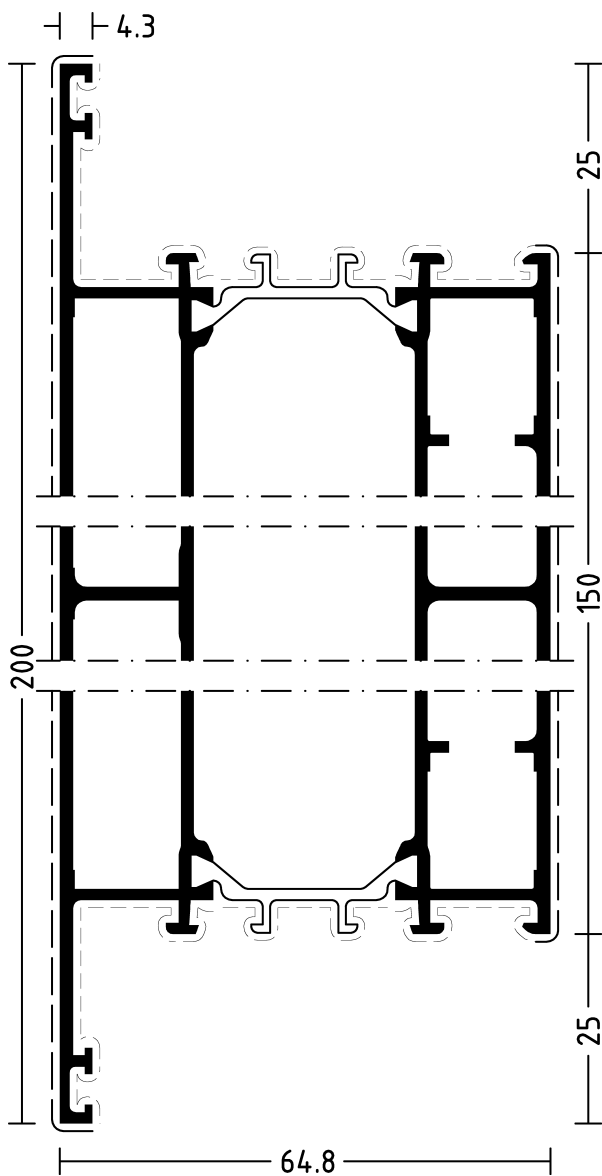





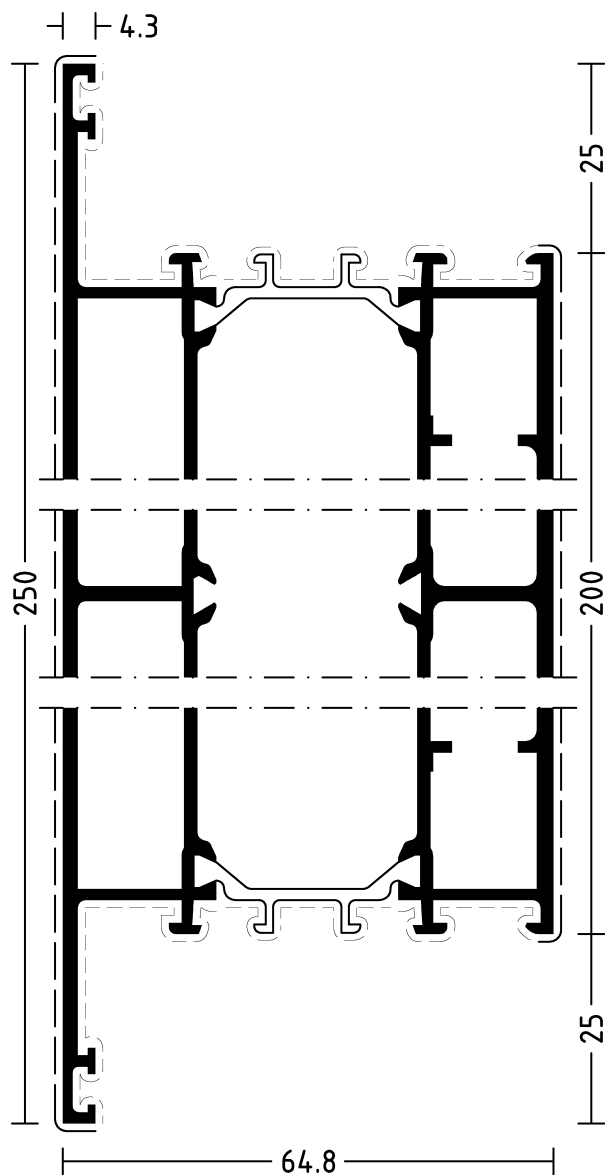









1916215

Stoßverbindungen mit Tür-Flügelprofilen WICSTYLE 65 Verbinder 4960059 (außen).
Butt joint connections with WICSTYLE 65 door leaf profiles, connector 4960059 (outside).



1916220

Stoßverbindungen mit Tür-Flügelprofilen WICSTYLE 65 Verbinder 4960061 (außen).
Butt joint connections with WICSTYLE 65 door leaf profiles, connector 4960061 (outside).

													
 1916224	6,5	779	530	-	-	2x4960013	2x4070000	2x4070030	5910004	5940101	5940001	-	
 1916336	6,5	253	64	-	-	2x4960004	2x4070000	2x4070030	5910004	5940101	5940001	-	
				-	-	-	-	-	-	-	-	-	
				-	-	-	-	-	-	-	-	-	

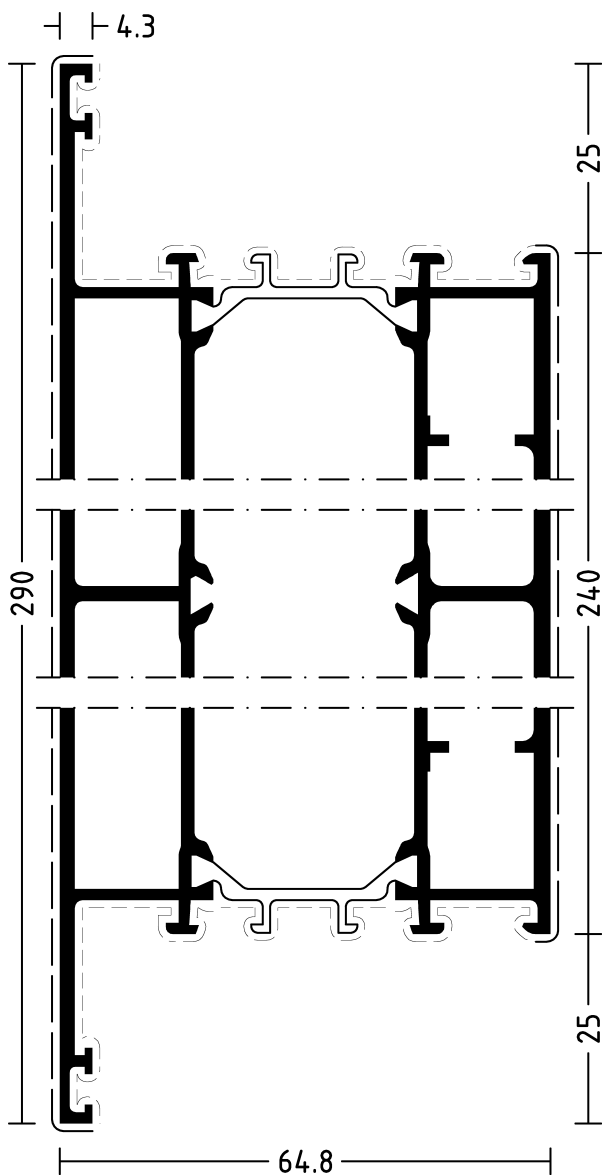





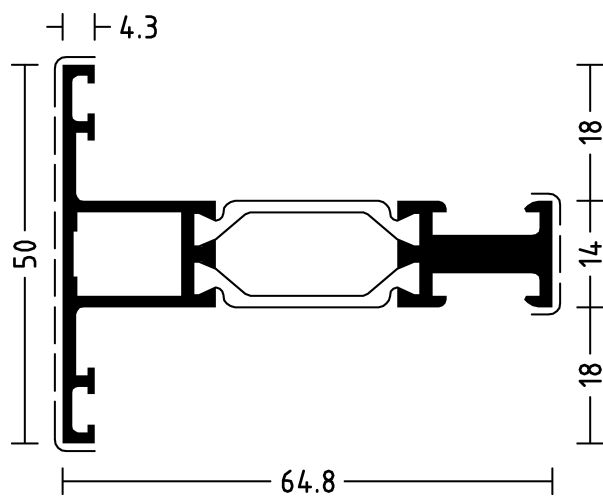









1916224

Stoßverbindungen mit Tür-Flügelprofilen WICSTYLE 65 Verbinder 4960063 (außen).
Butt joint connections with WICSTYLE 65 door leaf profiles, connector 4960063 (outside).



1916336

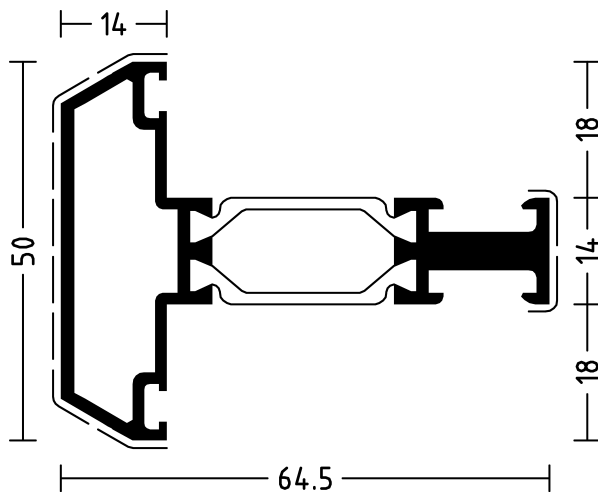

Stoßverbinder für alle Profilkombinationen siehe Seiten „Sprossenstoßverbindung“
See pages „butt joint connection of glazing bars“ for butt joint connector of all profile combinations

	 m	 mm	 mm										
 1916338	6,5	230	75	-	-	-	-	-	-	-	-	-	-
				-	-	-	-	-	-	-	-	-	-



1916338

Stoßverbinder für alle Profilkombinationen
siehe Seiten „Sprossenstoßverbindung“
See pages „butt joint connection of glazing bars“ for butt joint connector of all profile combinations

	m	mm	mm									
☒ 1916241	6,5	461	215	4950008	2x4070000	1x4960004	1x4070000	1x4070030	5910004	5940101	5940001	5930001
☒				4950008	2x4070000	1x4960004	1x4070000	1x4070030	5910004	5940101	5940001	5930001

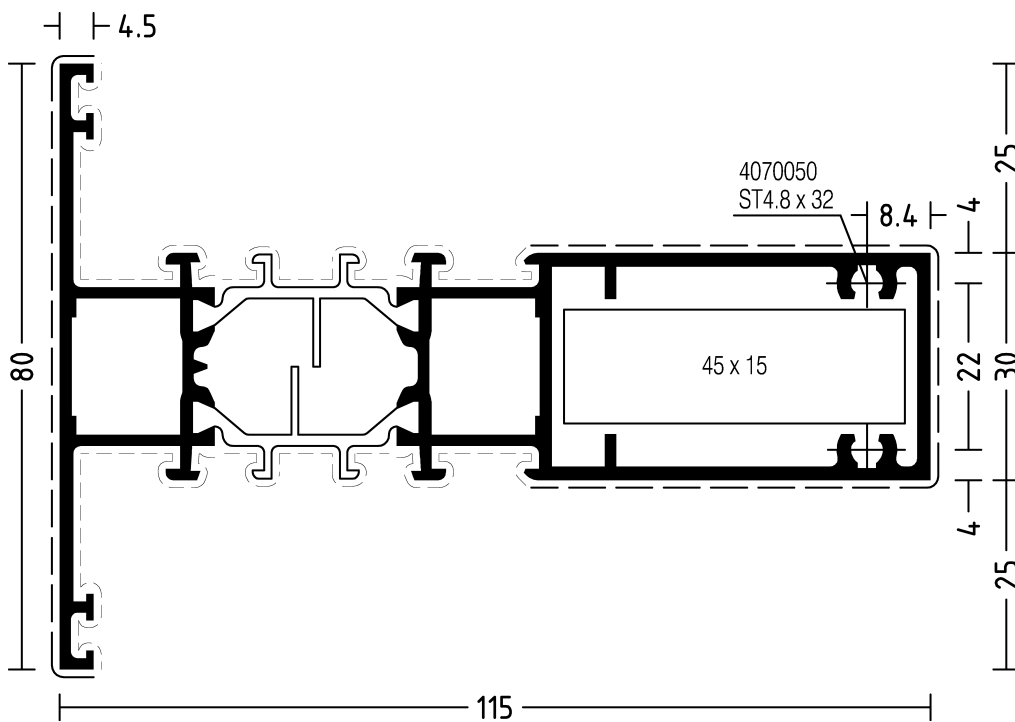















1916241

Gelenkeckwinkel und Gelenkverbinder siehe Zusatzartikel
See additional articles for hinged corner angles and hinged connectors.

WICSTYLE 65 evo / 65





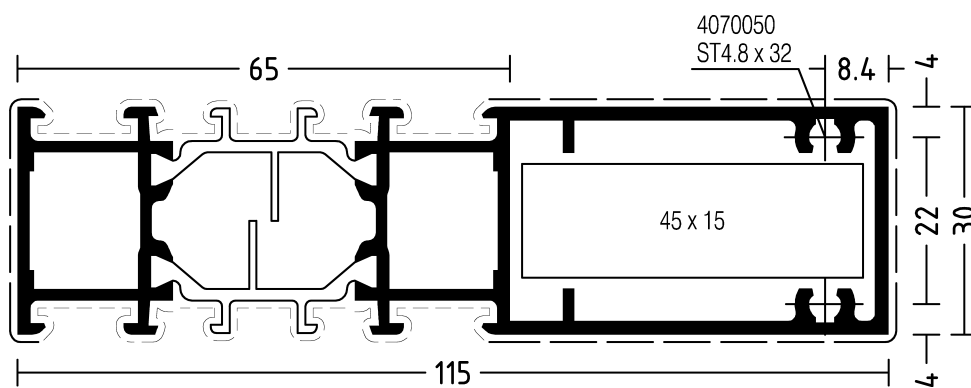









Stützenprofile
Mullion profiles

													
	m	mm	mm										
 1916244	6,5	336	165	4950008	2x4070000	1x4960004	1x4070000	1x4070030	5910004	5940101	5940001	5930001	
				4950008	2x4070000	1x4960004	1x4070000	1x4070030	5910004	5940101	5940001	5930001	



1916244

Gelenkeckwinkel und Gelenkverbinder siehe Zusatzartikel
See additional articles for hinged corner angles and hinged connectors.

													
	m	mm	mm										
 1916246	6,5	411	160	4950008	2x4070000	1x4960004	1x4070000	1x4070030	5910004	5940101	5940001	5930001	
				4950008	2x4070000	1x4960004	1x4070000	1x4070030	5910004	5940101	5940001	5930001	

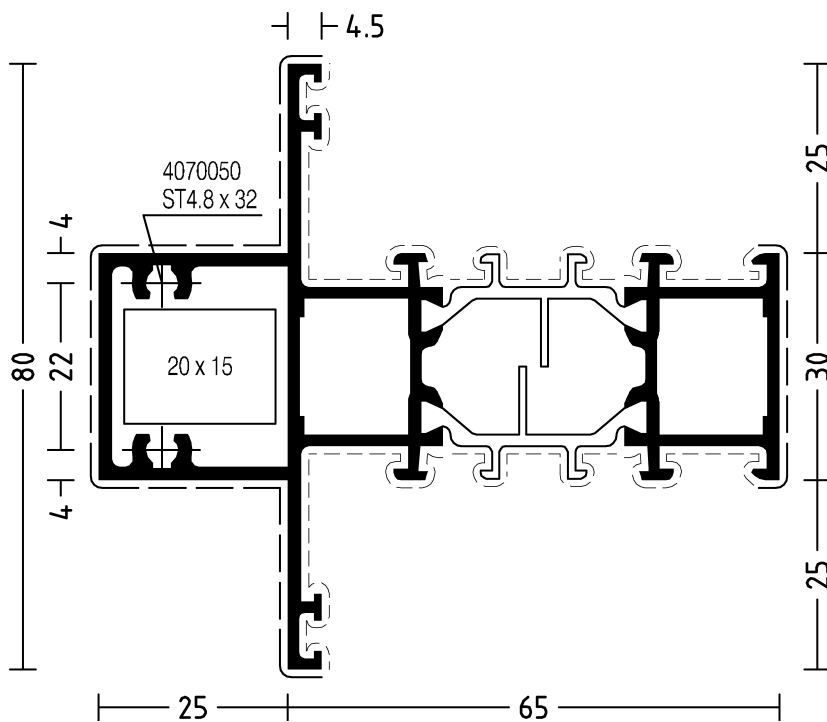











1916246

Gelenkeckwinkel und Gelenkverbinder siehe Zusatzartikel
See additional articles for hinged corner angles and hinged connectors.

WICSTYLE 65 evo / 65





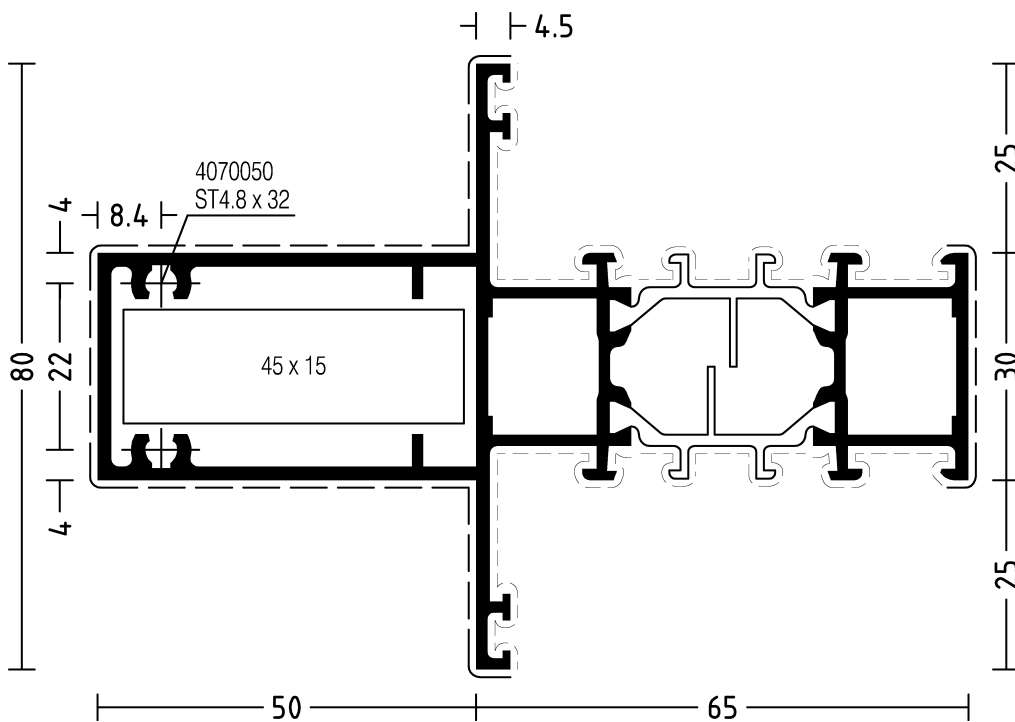









Stützenprofile
Mullion profiles

	m	mm	mm									
 1916247	6,5	461	210	4950008	2x4070000	1x4960004	1x4070000	1x4070030	5910004	5940101	5940001	5930001
				4950008	2x4070000	1x4960004	1x4070000	1x4070030	5910004	5940101	5940001	5930001



1916247

Gelenkeckwinkel und Gelenkverbinder siehe Zusatzartikel.
See additional articles for hinged corner angles and hinged connectors.

	 m	 mm	 mm									
 1916248	6,5	511	260	4950008	2x4070000	1x4960004	1x4070000	1x4070030	5910004	5940101	5940001	5930001
				4950008	2x4070000	1x4960004	1x4070000	1x4070030	5910004	5940101	5940001	5930001

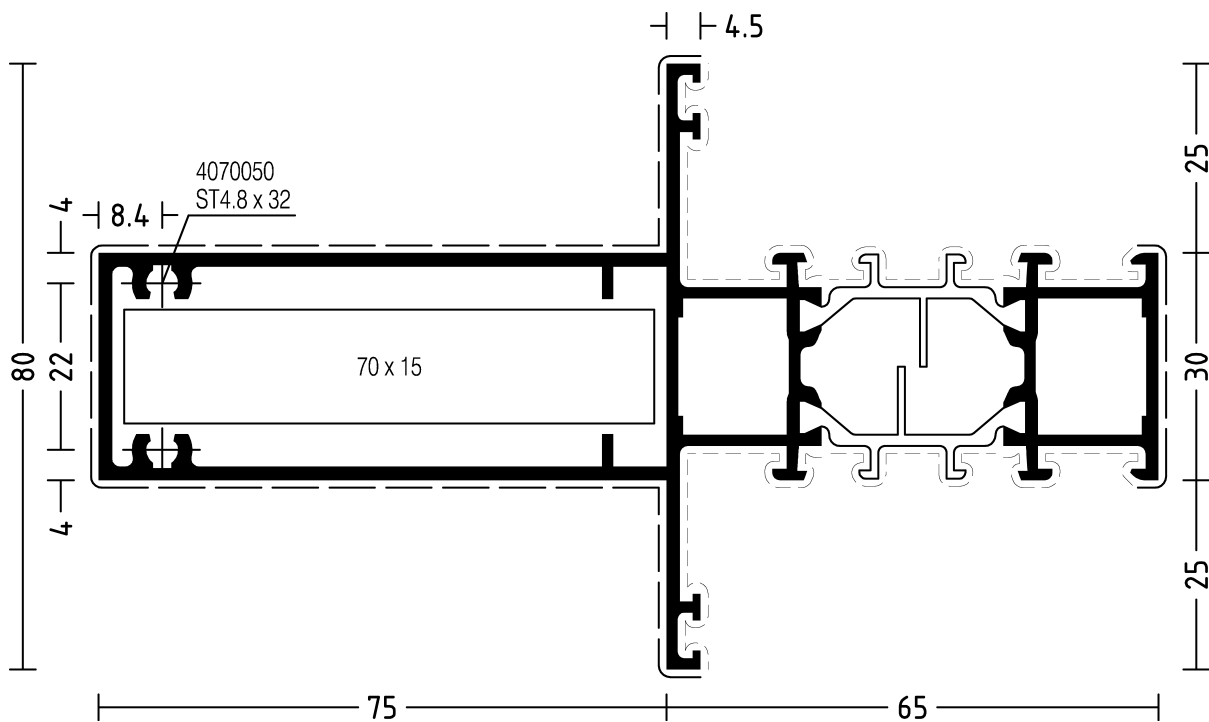















1916248

Gelenkeckwinkel und Gelenkverbinder siehe Zusatzartikel
See additional articles for hinged corner angles and hinged connectors.

WICSTYLE 65 evo / 65





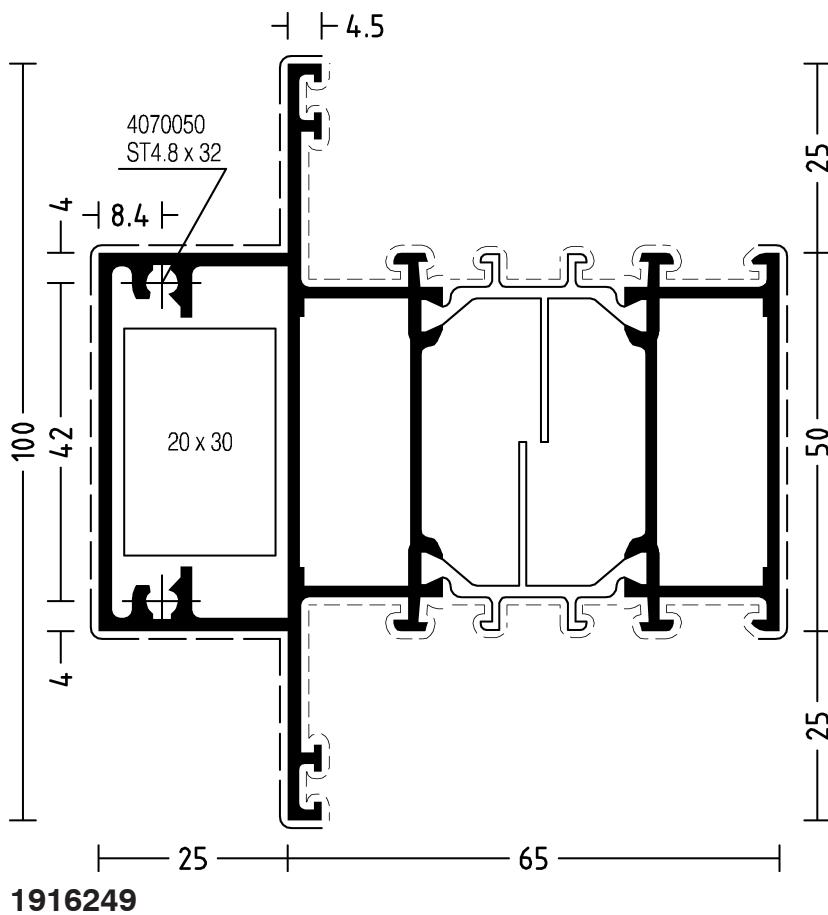









Stützenprofile
Mullion profiles

	 m	 mm	 mm										
 1916249	6,5	451	200	4950010	2x4070000	1x4960006	1x4070000	1x4070030	5910004	5940101	5940001	5930001	5930001
				4950010	2x4070000	1x4960006	1x4070000	1x4070030	5910004	5940101	5940001	5930001	5930001



WICSTYLE 65 evo / 65





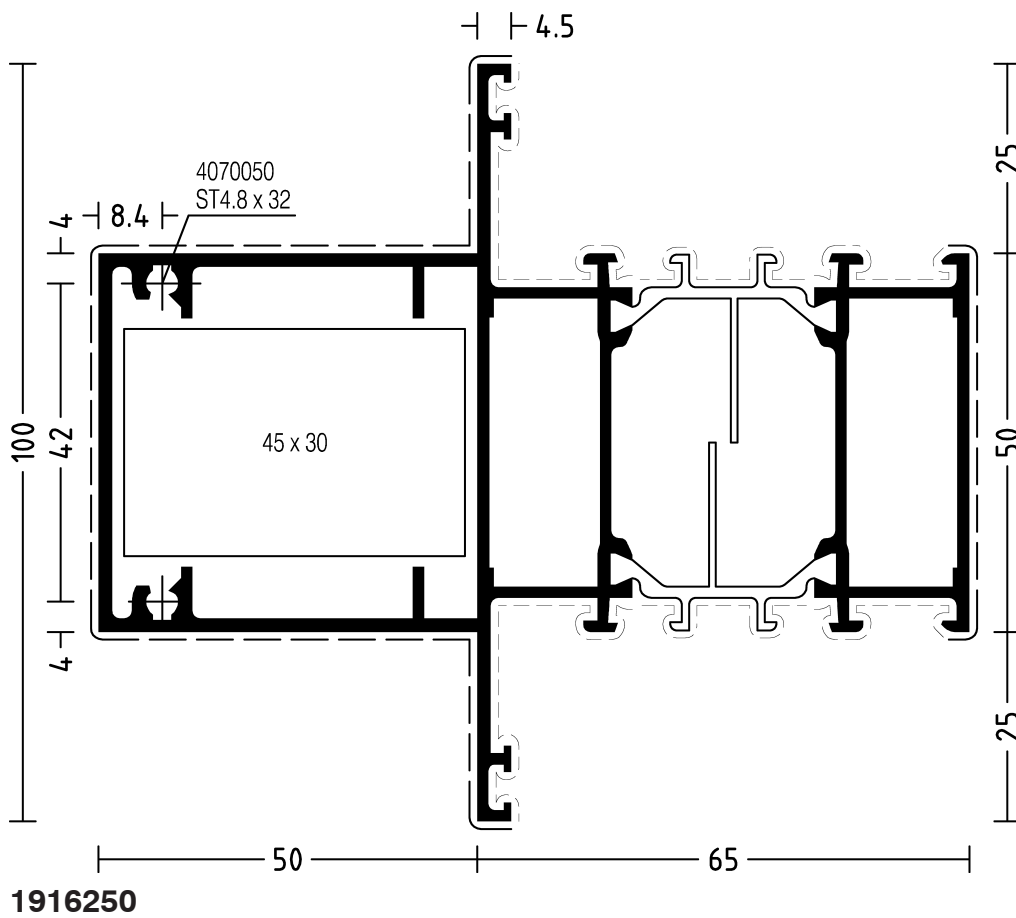







Stützenprofile
Mullion profiles

	 m	 mm	 mm									
 1916250	6,5	501	250	4950010	2x4070000	1x4960006	1x4070000	1x4070030	5910004	5940101	5940001	5930001
				4950010	2x4070000	1x4960006	1x4070000	1x4070030	5910004	5940101	5940001	5930001



WICSTYLE 65 evo / 65





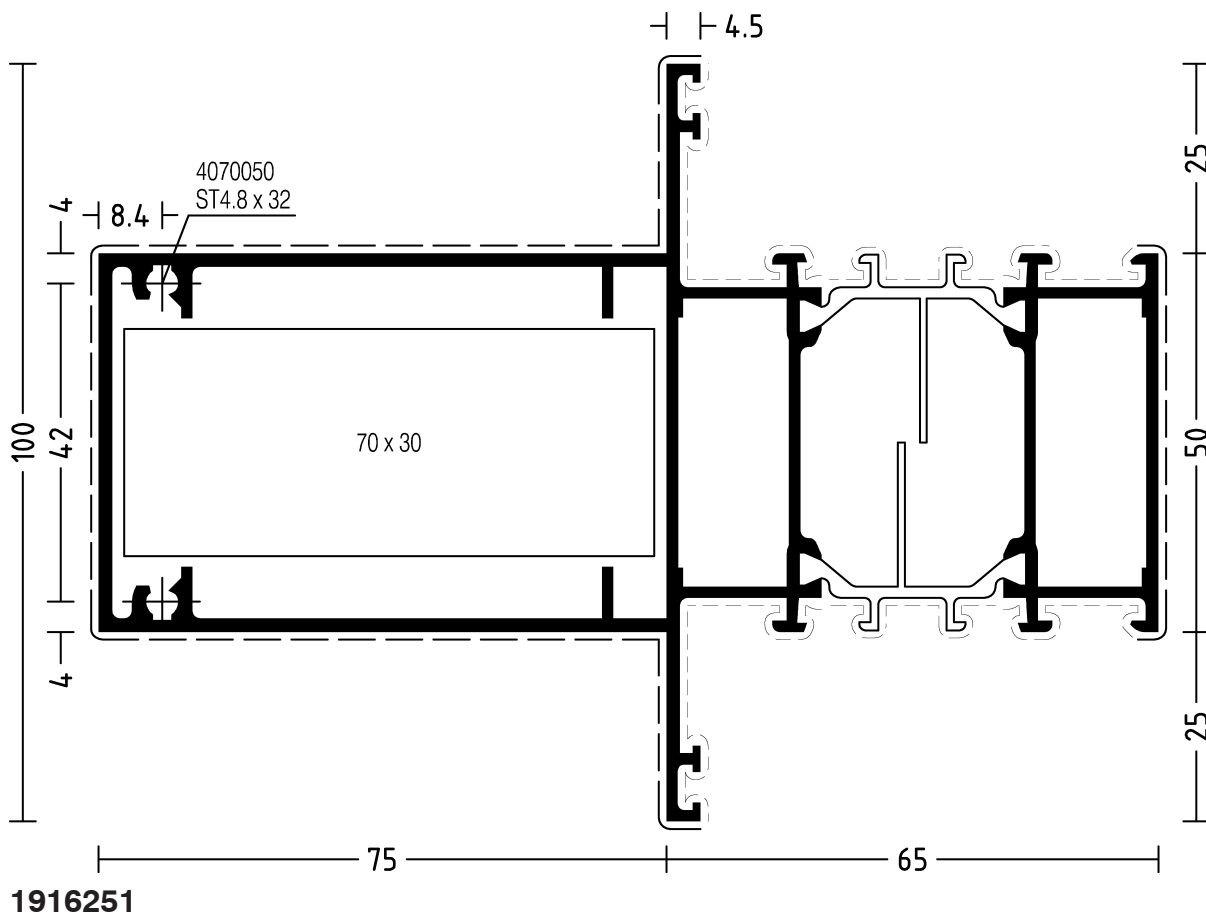





Stützenprofile
Mullion profiles

	m	mm	mm										
 1916251	6,5	551	300	4950010	2x4070000	1x4960006	1x4070000	1x4070030	5910004	5940101	5940001	5930001	
				4950010	2x4070000	1x4960006	1x4070000	1x4070030	5910004	5940101	5940001	5930001	



WICSTYLE 65 evo / 65





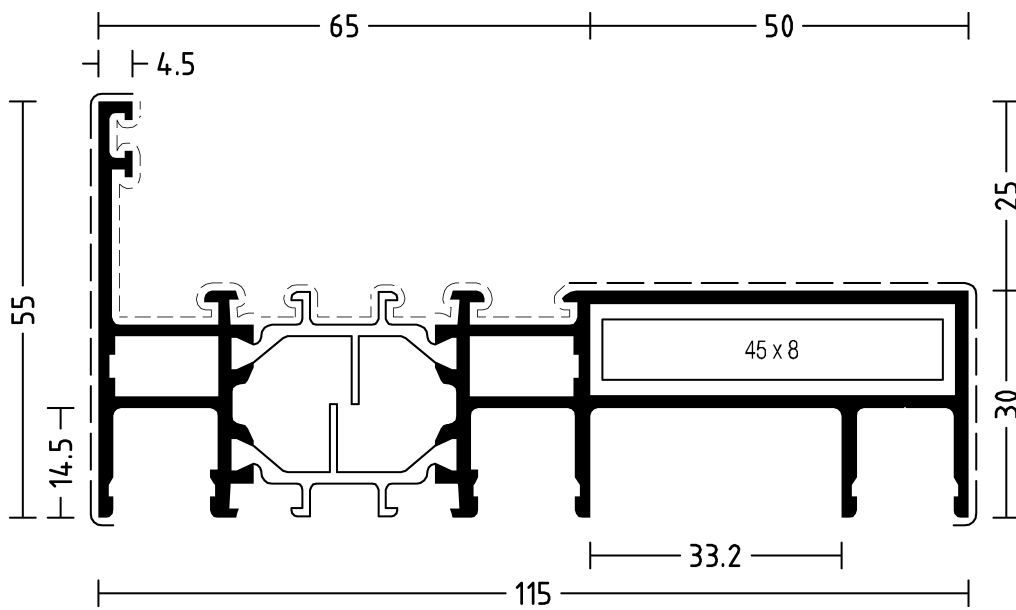









Stützenprofile
Mullion profiles

	m	mm	mm									
 1916256	6,5	486	138	4950005	2x4070009	-	-	-	5910004	-	-	5930001
				4950005	2x4070009	-	-	-	5910004	-	-	5930001



1916256





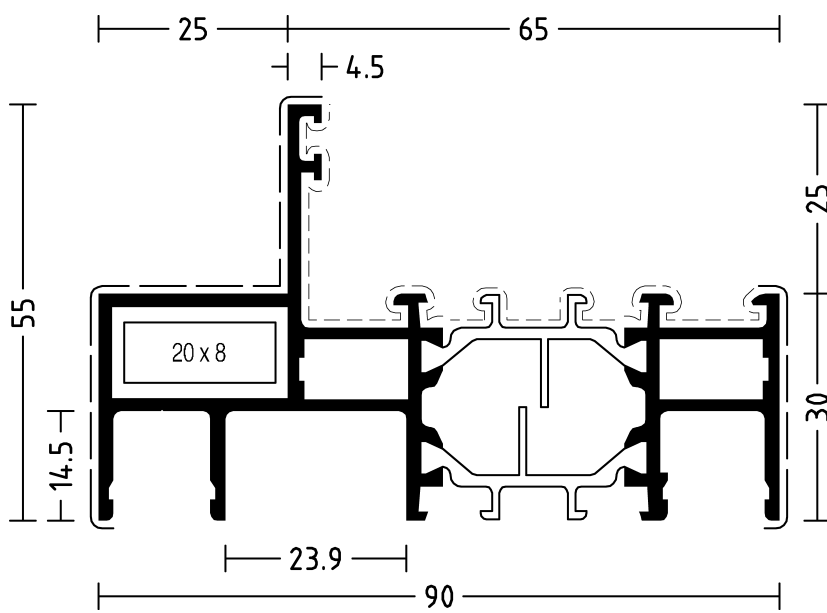

















Gelenkeckwinkel und Gelenkverbinder siehe Zusatzartikel.
See additional articles for hinged corner angles and hinged connectors.

												
	m	mm	mm									
 1916258	6,5	405	110	4950005	2x4070009	-	-	-	5910004	-	-	5930001
				4950005	2x4070009	-	-	-	5910004	-	-	5930001



1916258





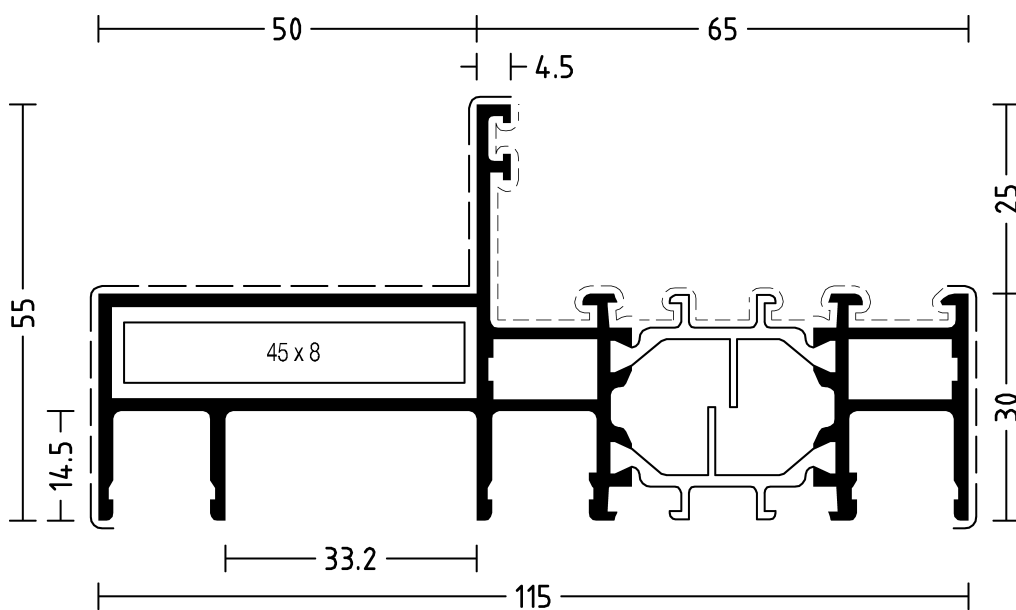









Gelenkeckwinkel und Gelenkverbinder siehe Zusatzartikel
See additional articles for hinged corner angles and hinged connectors.

												
	m	mm	mm									
 1916259	6,5	486	135	4950005	2x4070009	-	-	-	5910004	-	-	5930001
				4950005	2x4070009	-	-	-	5910004	-	-	5930001



1916259

Gelenkeckwinkel und Gelenkverbinder siehe Zusatzartikel.
See additional articles for hinged corner angles and hinged connectors.

												
	m	mm	mm									
 1916260	6,5	536	160	4950005	2x4070009	-	-	-	5910004	-	-	5930001
				4950005	2x4070009	-	-	-	5910004	-	-	5930001

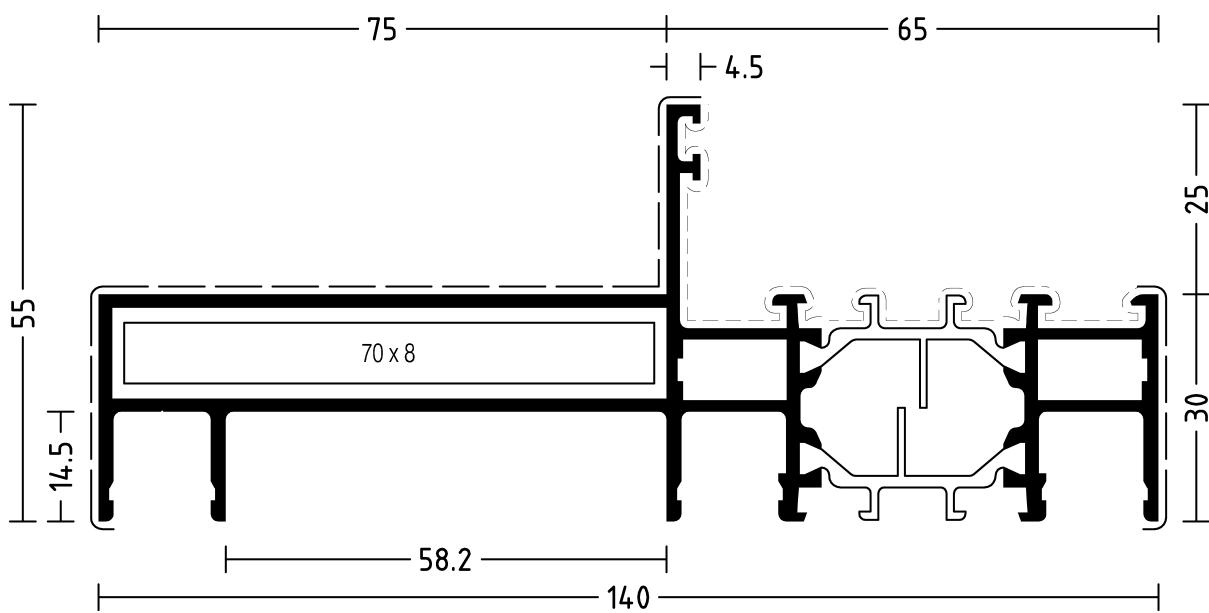















1916260

Gelenkeckwinkel und Gelenkverbinder siehe Zusatzartikel
See additional articles for hinged corner angles and hinged connectors.

WICSTYLE 65 evo / 65

Stützenprofile
Mullion profiles



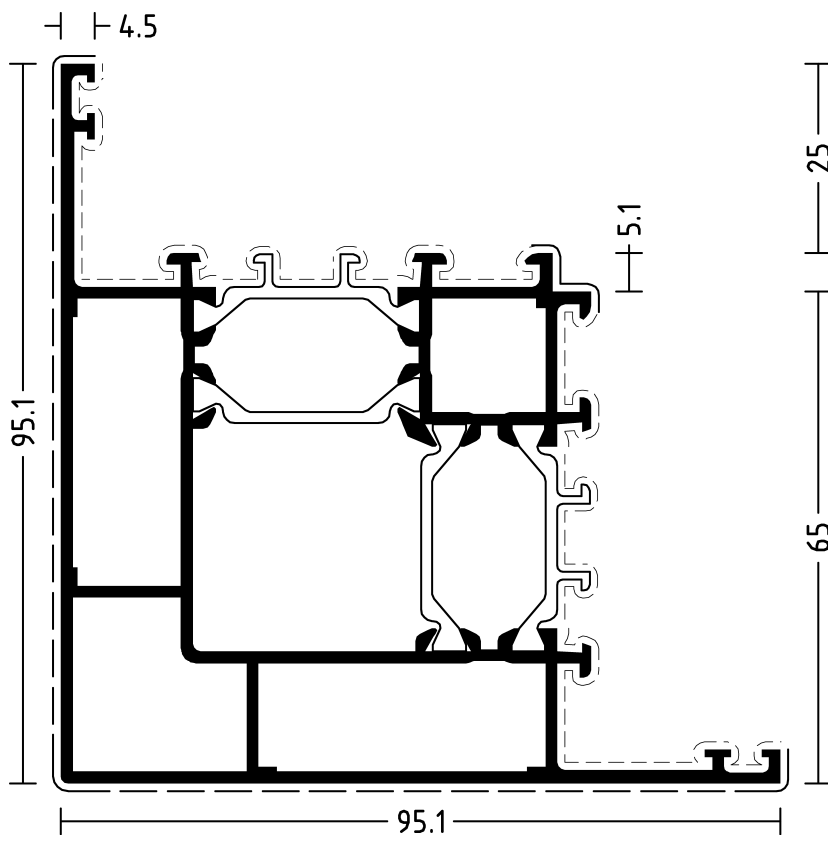











													
	m	mm	mm										
 1916270	6,5	451	200	-	-	2x4960006	2x4070000	2x4070030	5910004	5940101	5940001	-	-
				-	-	-	-	-	5910004	5940101	5940001	-	-



1916270







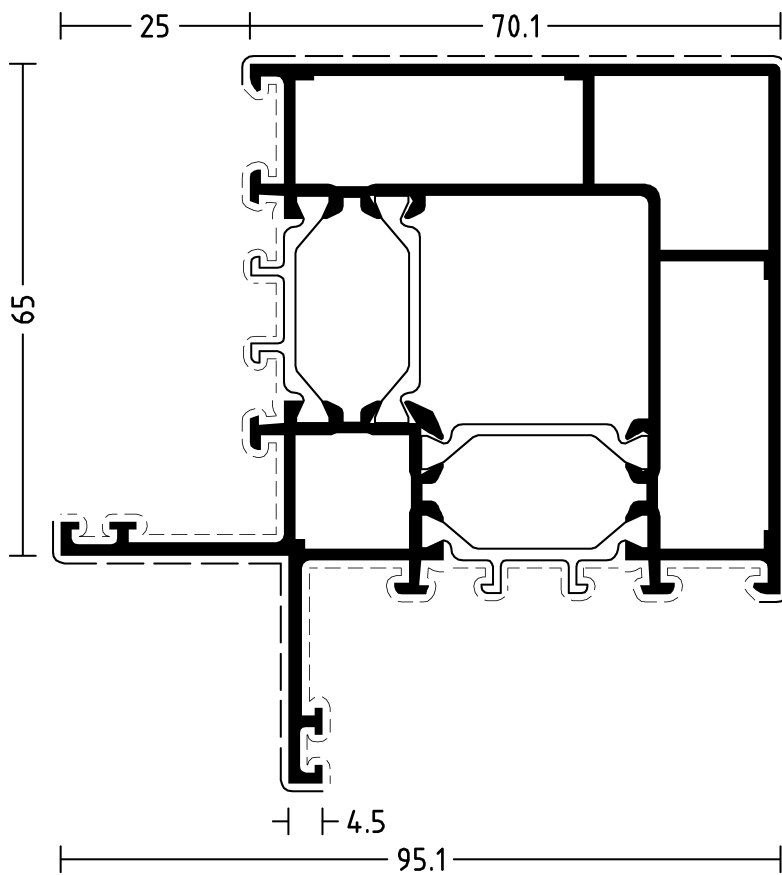







WICSTYLE 65 evo / 65

Stützenprofile
Mullion profiles

	 m	 mm	 mm									
 1916271	6,5	451	200	-	-	-	-	-	5910004	5940101	5940001	-
	-	-	-	-	-	2x4960006	2x4070000	2x4070030	5910004	5940101	5940001	-



1916271

													
	m	mm	mm										
 1916272	6,5	326	150	-	-	2x4960006	2x4070000	2x4070030	5910004	5940101	5940001	-	-
 1916273	6,5	266	90	-	-	2x4960004	2x4070000	2x4070030	5910004	5940101	5940001	-	-
				-	-	1x4960050	2x4070009	-	5910004	5940101	5940001	-	-

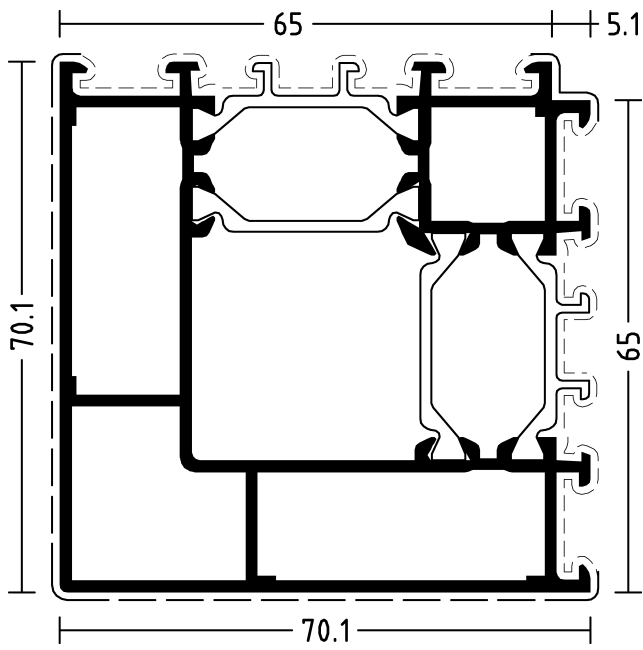

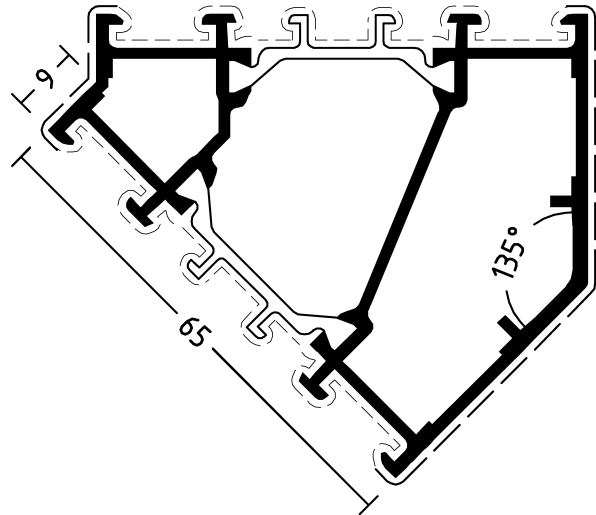

1916272



1916273



WICSTYLE 65 evo / 65

Kupplungsprofile
Coupling profiles

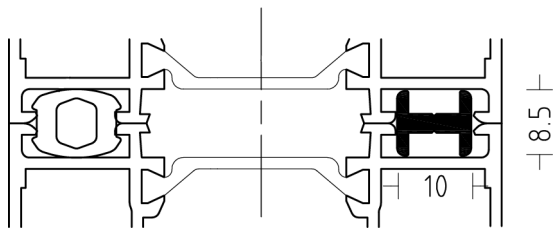
	 m	 mm	 mm
134026	6	47	0



134026

	 m	 mm	 mm
1020457	6,5	248	68
1926524	6,5	229	48
1926525	6,5	198	45
1926526	6,5	197	70
1926547	6,5	177	44
3926500	6,5	260	48

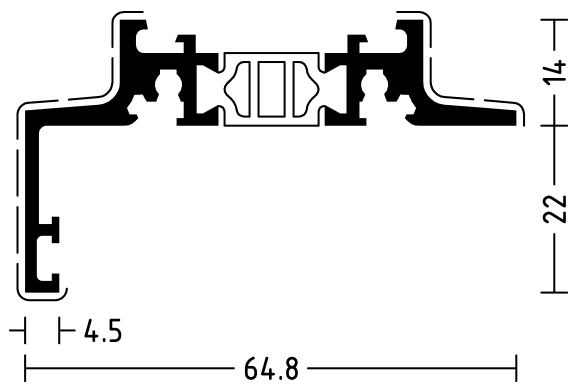

1020457

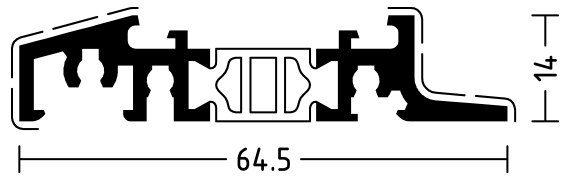

1926524

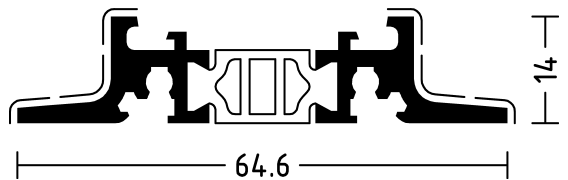

1926525

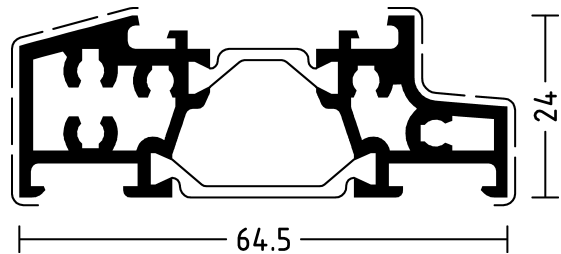

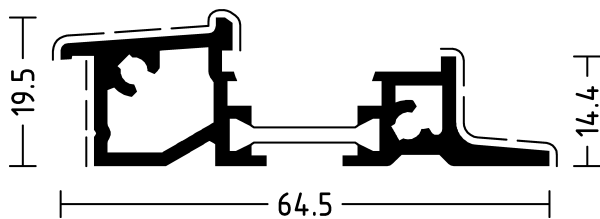

1926526

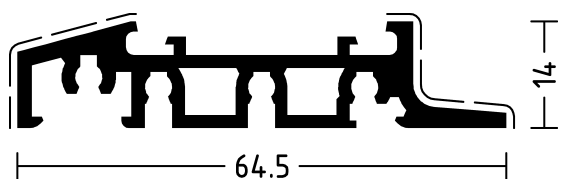

1926547



3926500

	 m	 mm	 mm
3926501	6,5	106	0
3021033	6	74	0
3926502	6,5	199	78
3926512	6,5	231	88

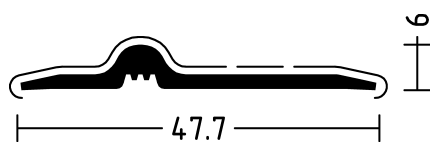

3926501

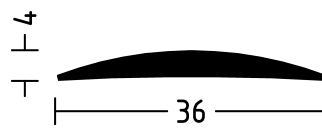

3021033

Schwellenprofil für Schleifdichtung
Threshold profile for sliding gasket

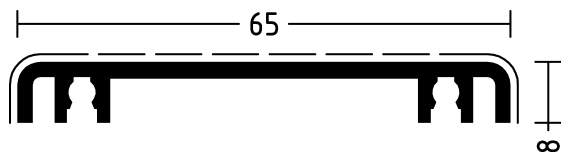

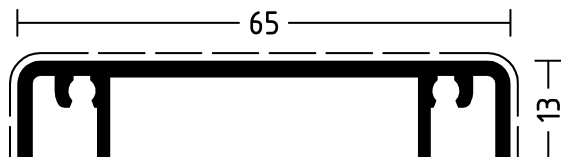

3926502



3926512

WICSTYLE 65 evo / 65

Wetterschenkelprofile
Weatherproofing profiles

	 m	 mm	 mm
3925099	6,5	126	21
3925100	6,5	81	21
3020191	6,5	208	40

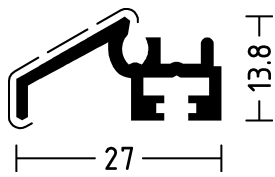

3925099

Vorgebohrt
Pre-drilled

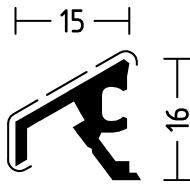



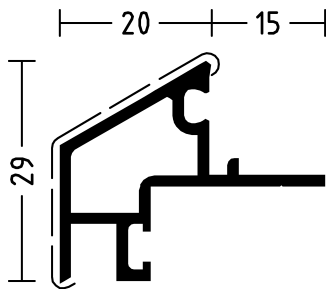











3925100











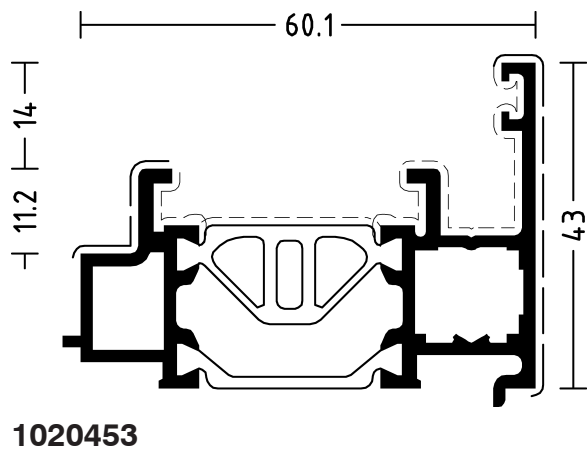
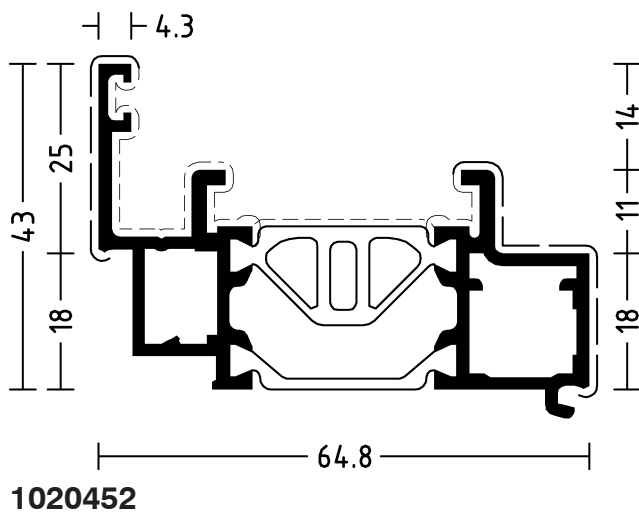







3020191

WICSTYLE 65 evo / 65

Aufsatzprofile Supplementary profiles

										
	 m	 mm	 mm							
 1020452	6,5	247	67	-	-	-	-	-	-	-
 1020453	6,5	251	59	-	-	-	-	-	-	-
				-	-	-	-	-	-	-





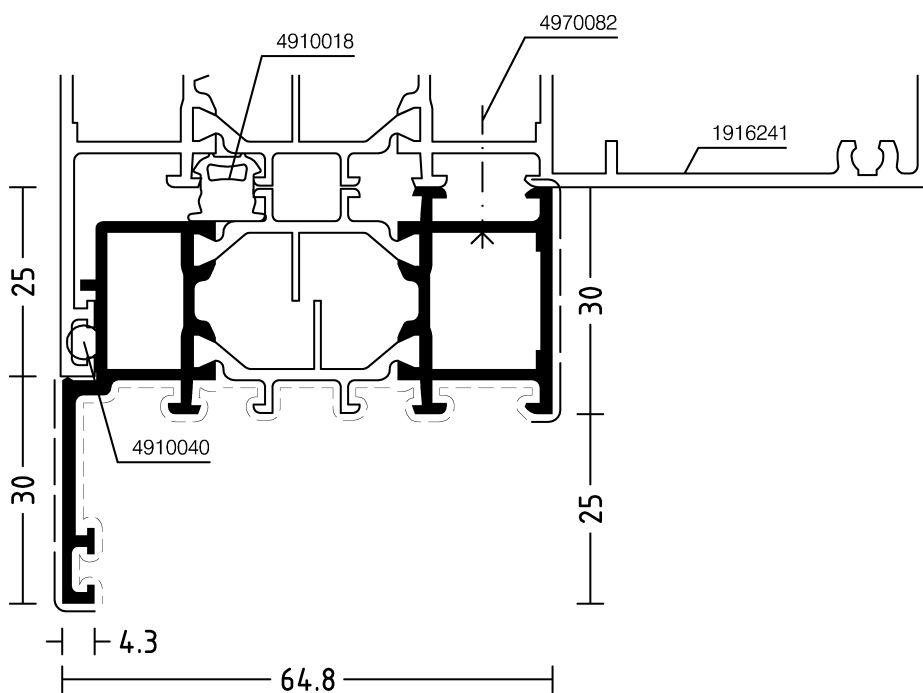













													
	m	mm	mm										
 1916301	6,5	275	60	4950057	-	-	-	-	-	-	-	-	5930001
				4950008	2x4070000	-	-	-	-	5940101	-	-	5930001



1916301

Falzverbreiterungsprofil
Eckverbindung außen:
Selbstzuschnitt oder Al-Eckwinkel konfektioniert 4950057.

*Rebate widening profile
Corner connection outer shell:
Self-cut or prefabricated corner angle 4950057.*

													
	m	mm	mm										
 1916303	6,5	277	60	4950057	-	-	-	-	-	-	-	5930001	-
 				4950008	2x4070000	-	-	-	-	5940101	-	5930001	-
1926520	6,5	168	39	-	-	-	-	-	-	-	-	-	-
				-	-	-	-	-	-	-	-	-	-

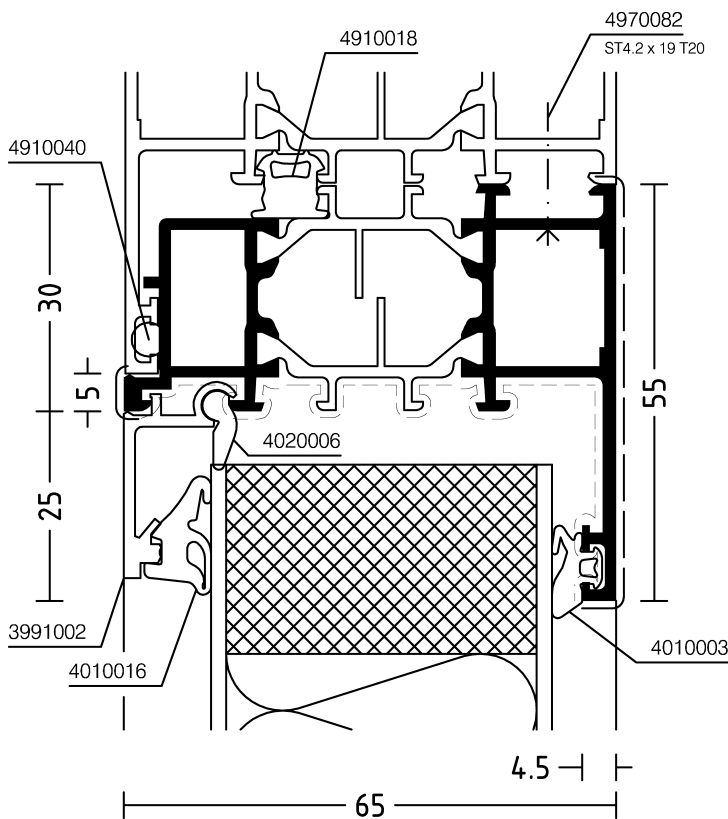

1916303



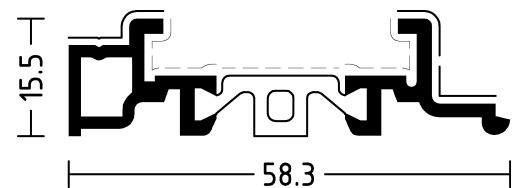











Wechselprofil von außen verglast!
 Eckverbindung außen:
 Selbstzuschnitt oder Al-Eckwinkel konfektioniert 4950057.
 Stoßverbindung nicht möglich.
 Profil nicht für Beschlagseinbau geeignet!
Rebate reversion profile, glazing from outside!
Corner connection outer shell:
Self-cut or prefabricated corner angle 4950057.
Butt-joint connection not possible.
Profile not suitable for fitting installation!



1926520

WICSTYLE 65 evo / 65

Aufsatzprofile Supplementary profiles

														
		m	mm	mm										
	1926521	6,5	250	72	-	-	-	-	-	-	-	-	-	-
	1926522	6,5	269	68	-	-	-	-	-	-	-	-	-	-
	1926523	6,5	275	62	-	-	-	-	-	-	-	-	-	-

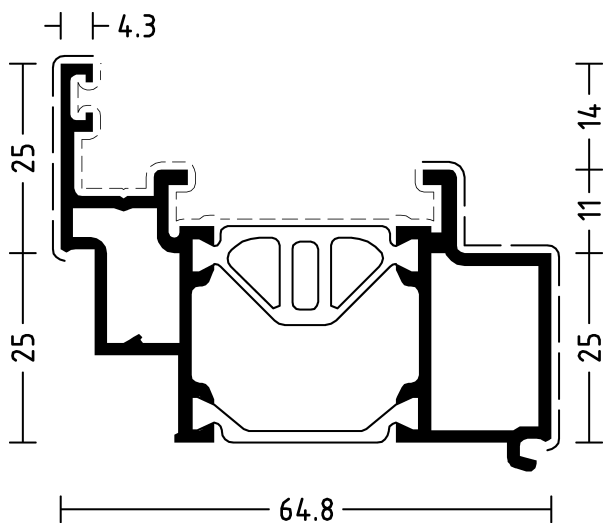



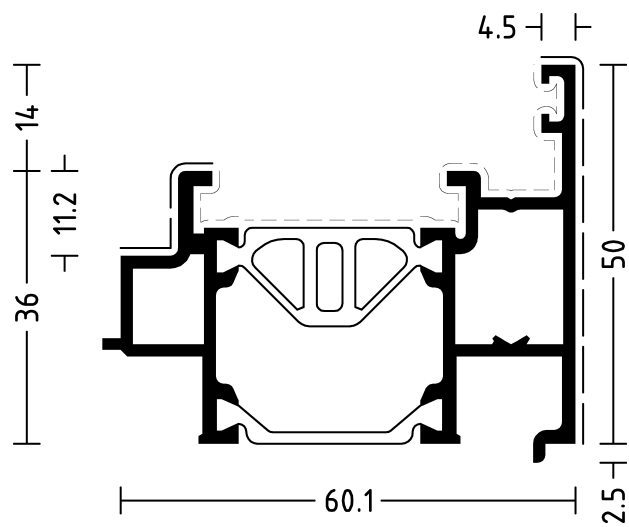



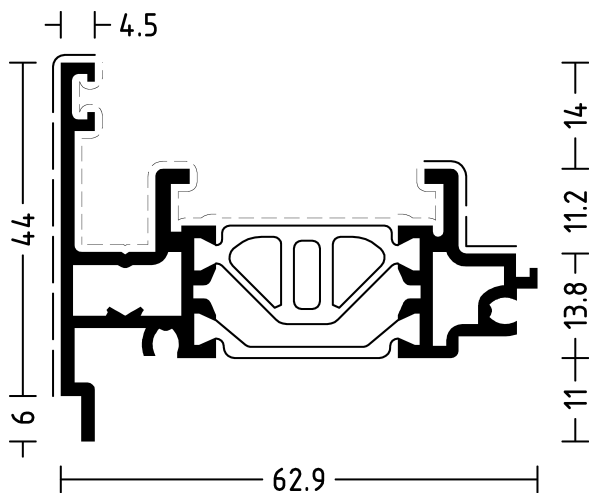





1926521



1926522



1926523

	m	mm	mm										
 1926527	6,5	384	158	-	-	1x4960069	1x4070000	1x4070030	5910004	5940101	5940001	-	-
 1926528	6,5	404	178	-	-	1x4960071	2x4070000	2x4070030	5910004	5940101	5940001	-	-
1926528	6,5	404	178	-	-	1x4960070	1x4070000	1x4070030	5910004	5940101	5940001	-	-
				-	-	1x4960072	2x4070000	2x4070030	5910004	5940101	5940001	-	-

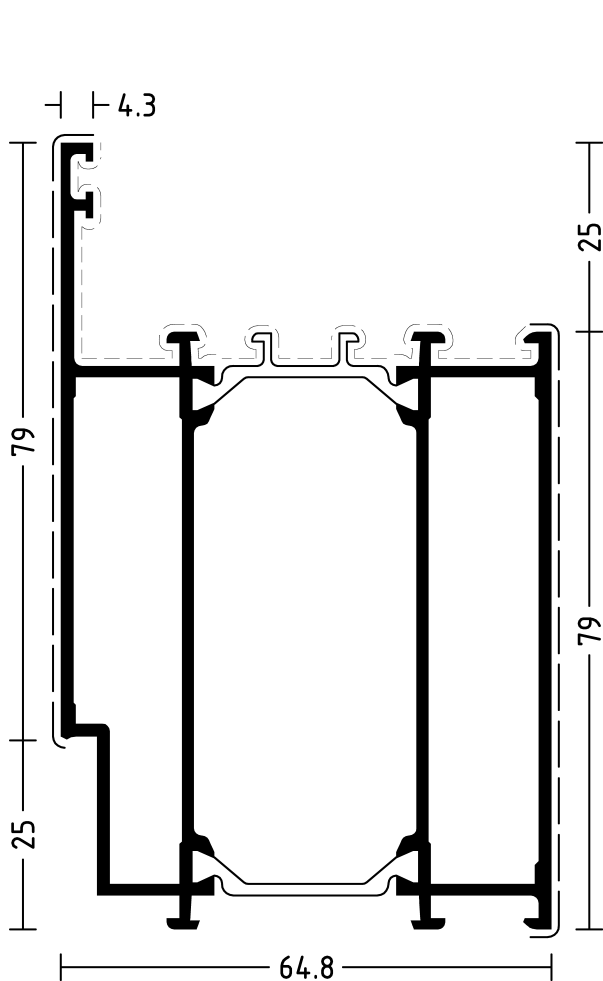

1926527

Stoßverbindungen mit Tür-Flügelprofilen WICSTYLE 65 Verbinder 4960067 (außen).
Butt joint connections with WICSTYLE 65 door leaf profiles, connector 4960067 (outside).

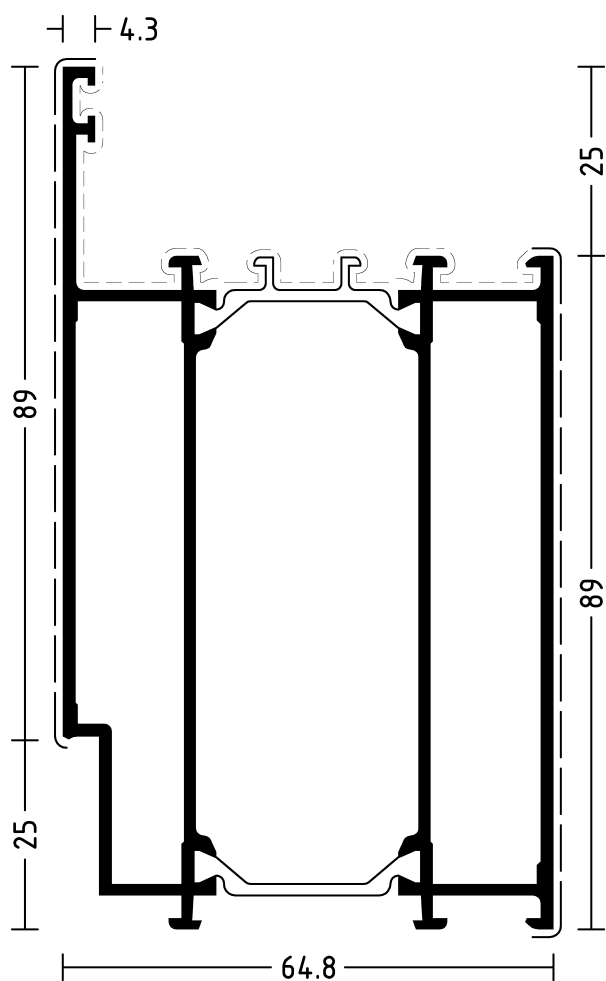















1926528

Stoßverbindungen mit Tür-Flügelprofilen WICSTYLE 65 Verbinder 4960068 (außen).
Butt joint connections with WICSTYLE 65 door leaf profiles, connector 4960068 (outside).

WICSTYLE 65 evo / 65

Aufsatzprofile Supplementary profiles

											
	 m	 mm	 mm								
 1926529	6,5	164	18	-	-	-	-	-	-	-	-
 1926530	6,5	228	48	-	-	-	-	-	-	-	-
1926531	6,5	178	25	-	-	-	-	-	-	-	-

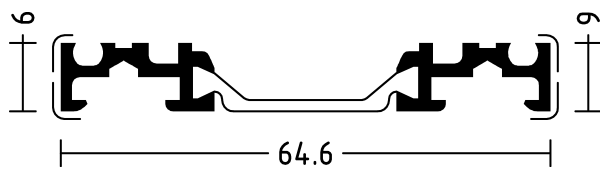

1926529

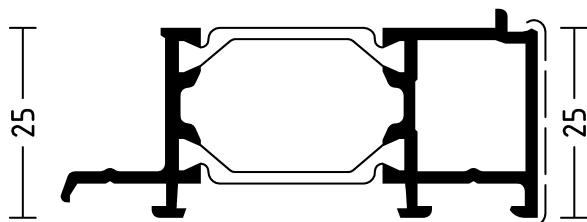
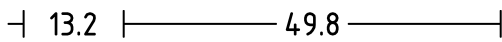



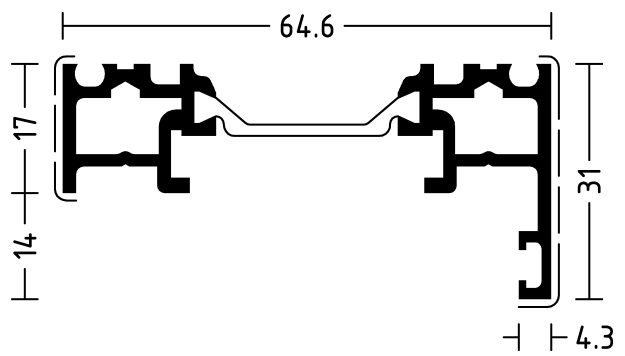



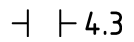







1926531



1926530



	 m	 mm	 mm									
 1926532	6,5	232	43	-	-	-	-	-	-	-	-	-
				-	-	-	-	-	-	-	-	-
1926533	6,5	247	48	-	-	-	-	-	-	-	-	-
				-	-	-	-	-	-	-	-	-
1926537	6,5	253	47	-	-	-	-	-	-	-	-	-
				-	-	-	-	-	-	-	-	-

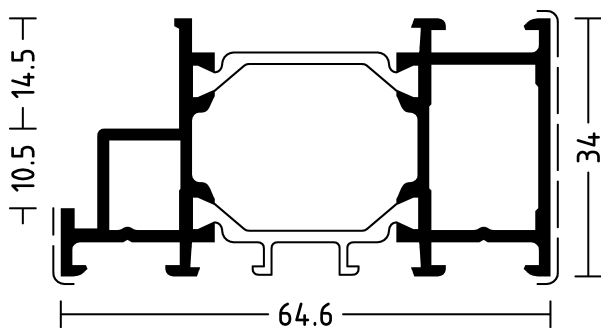

1926532

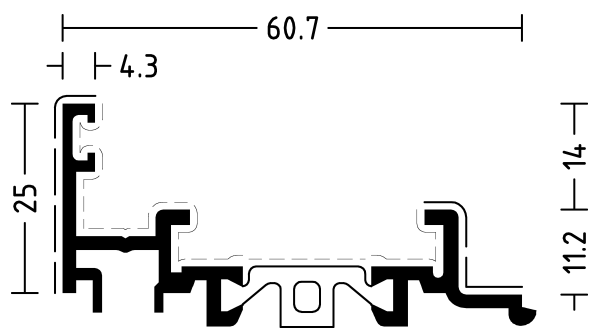

1926533

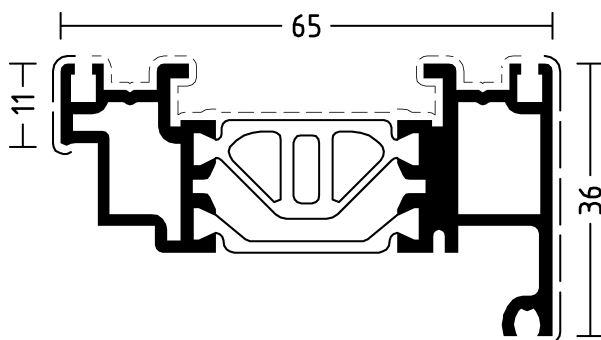















1926537

Pendeltüren
Verwendung: WICSTYLE 65

Double action doors
Application: WICSTYLE 65

WICSTYLE 65 evo / 65

Aufsatzprofile Supplementary profiles

													
	m	mm	mm										
 1926538	6,5	260	47	-	-	-	-	-	-	-	-	-	-
 1926539	6,5	213	22	-	-	-	-	-	-	-	-	-	-
1926545	6,5	264	47	-	-	-	-	-	-	-	-	-	-

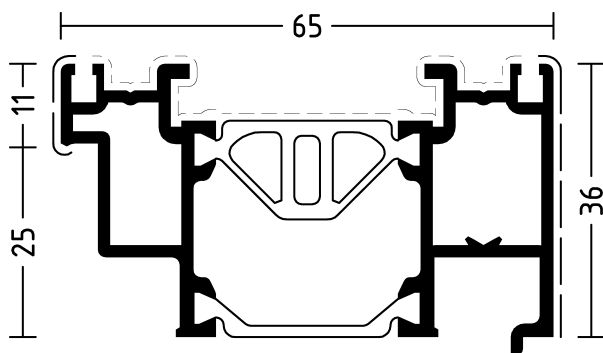

1926538

Pendeltüren
Verwendung: WICSTYLE 65
Double action doors
Application: WICSTYLE 65

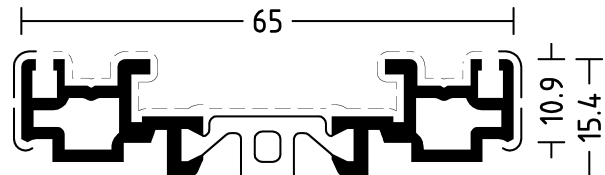



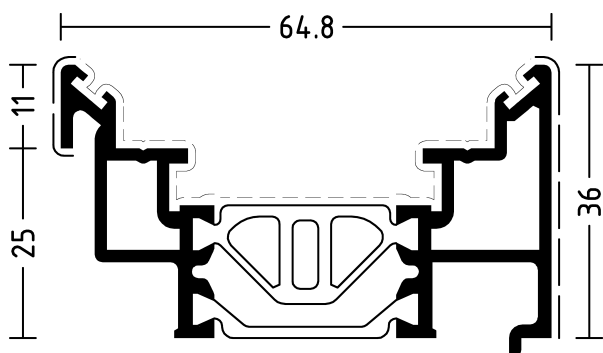











1926539



1926545

für Pendeltür
for double action door

	 m	 mm	 mm									
 3021035	6	193	65	-	-	-	-	-	-	-	-	-
 3926504	6,5	274	0	-	-	-	-	-	-	-	-	-
3926505	6,5	271	0	-	-	-	-	-	-	-	-	-

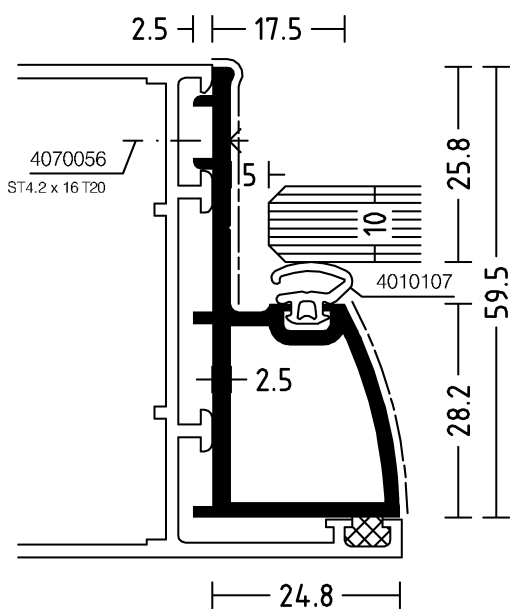

3021035

Ganzglastüren Verwendung WICSTYLE 65
All-glass doors application WICSTYLE 65

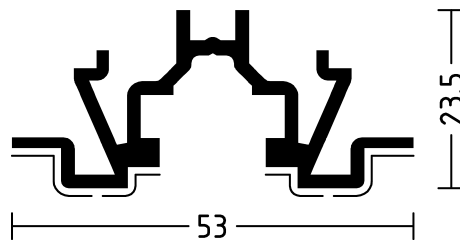

3926504

Pendeltüren
Beschlagaufnahmeprofil
Verwendung: WICSTYLE 65
Double action doors
Fitting support profile
Application: WICSTYLE 65

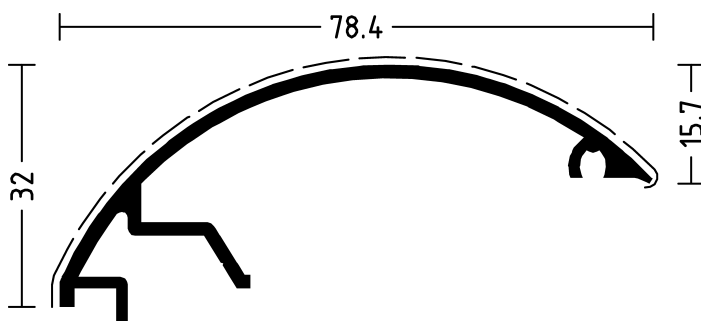















3926505

für Pendeltüren
for double action doors

WICSTYLE 65 evo / 65

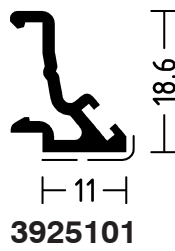
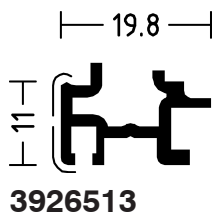

Aufsatzprofile Supplementary profiles

	 m	 mm	 mm										
 3926513	6,5	109	11	-	-	-	-	-	-	-	-	-	-
 3925101	6,5	92	11	-	-	-	-	-	-	-	-	-	-
				-	-	-	-	-	-	-	-	-	-





WICSTYLE 65 evo / 65

Abdeckprofile
Cover profiles

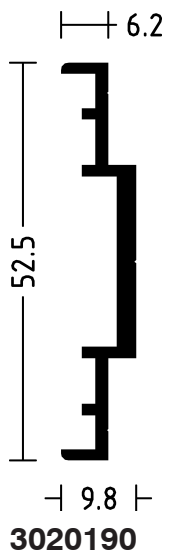
			
	m	mm	mm
3020190	6,5	152	0



	 m	 mm	 mm
3021018	6,5	227	24
3091061	6,5	260	92
3091062	6,5	224	81
3091063	6,5	358	50

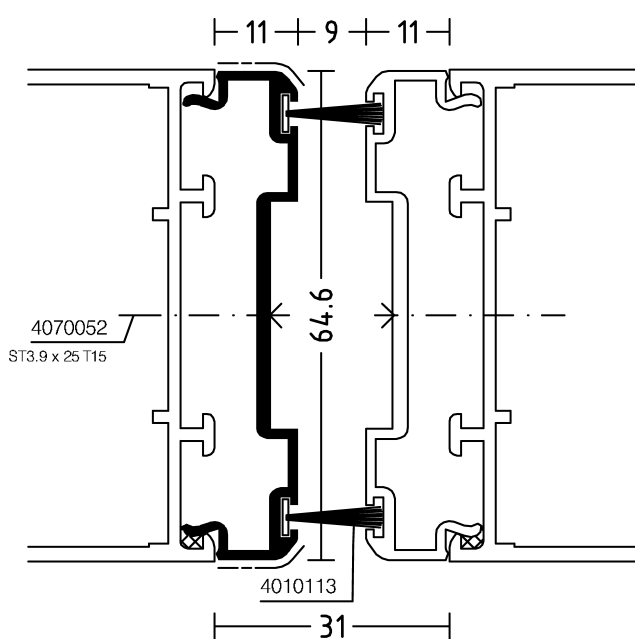

3021018

Pendeltür - Aufsatzprofil für Blendrahmen und Flügel
Double action door supplementary profile for frame and leaf profiles.

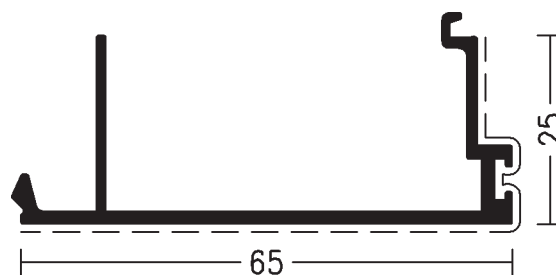

3091061

Automatische Schiebetüren
Automatic sliding doors

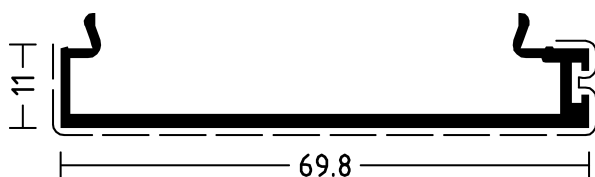

3091062

Automatische Schiebetüren
Automatic sliding doors

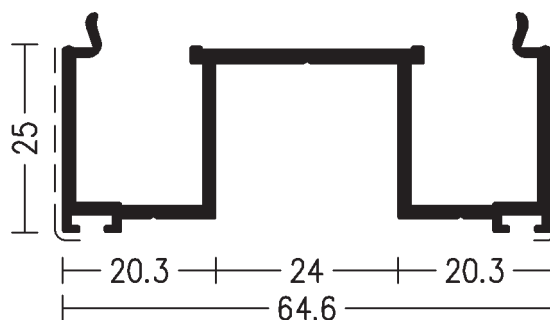

3091063

Automatische Schiebetüren
Automatic sliding doors

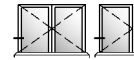
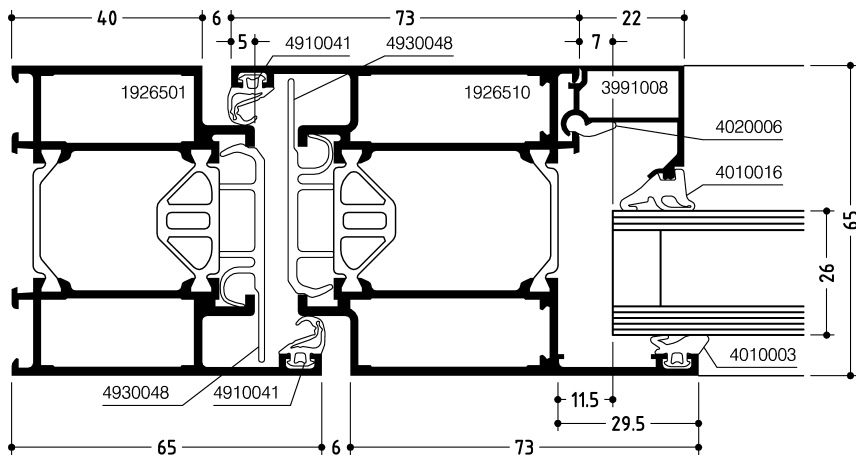

DOC-0000638620

Anschlagtüren
einwärts mit Spezi-
alblendrahmen
*Hinged doors
inwards with
special frame*

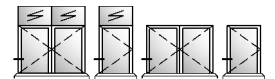
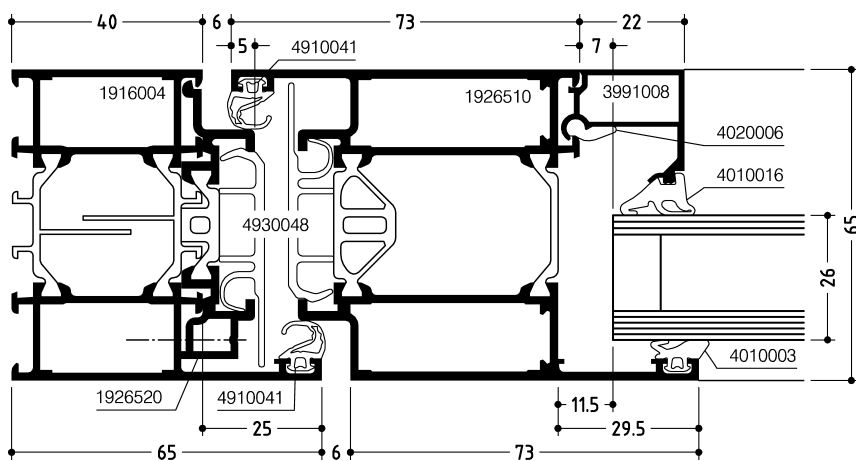

DOC-0000638746

Anschlagtüren
einwärts mit Kombi-
nationsblendrah-
men
*Hinged doors
inwards with
combination frame*

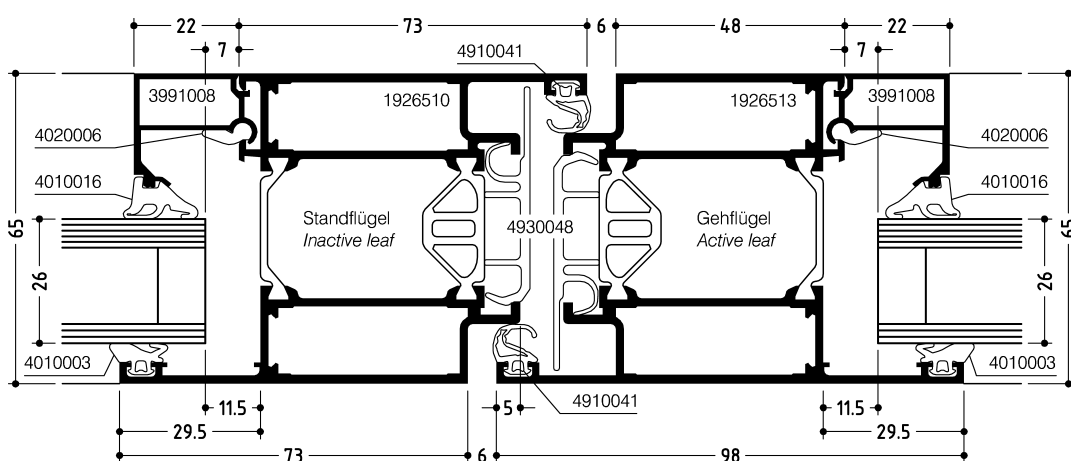

DOC-0000676643

Anschlagtüren
auswärts, Mittel-
stoß ohne Aufsatz-
profil
*Hinged doors
outwards, meeting
stiles without
supplementary
profile*

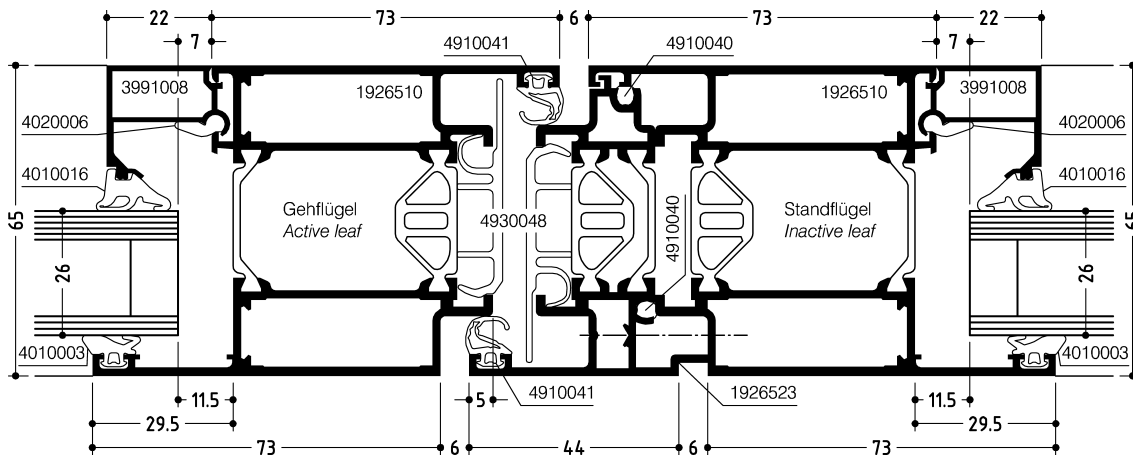

DOC-0000676714

Anschlagtüren
einwärts, Mittelstoß
mit Aufsatzprofil
*Hinged doors
inwards, meeting
stiles with
supplementary
profile*

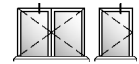
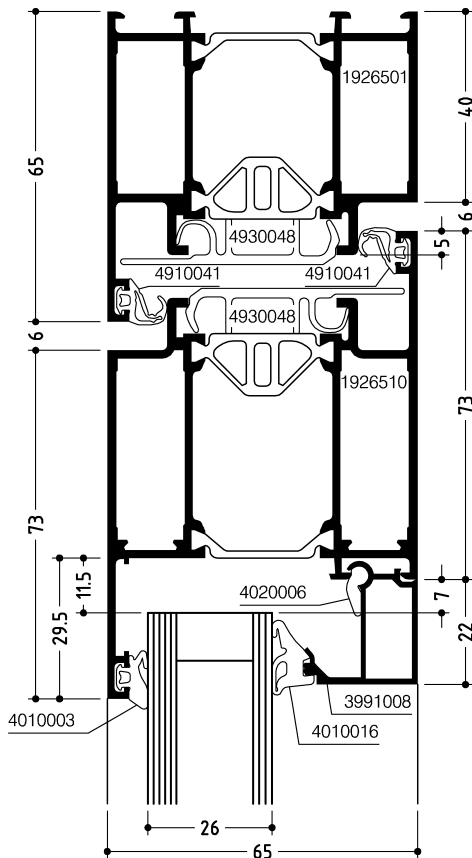

DOC-0000638868

Anschlagtüren
einwärts mit Spezi-
alblendrahmen
*Hinged doors
inwards with
special frame*

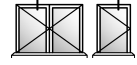
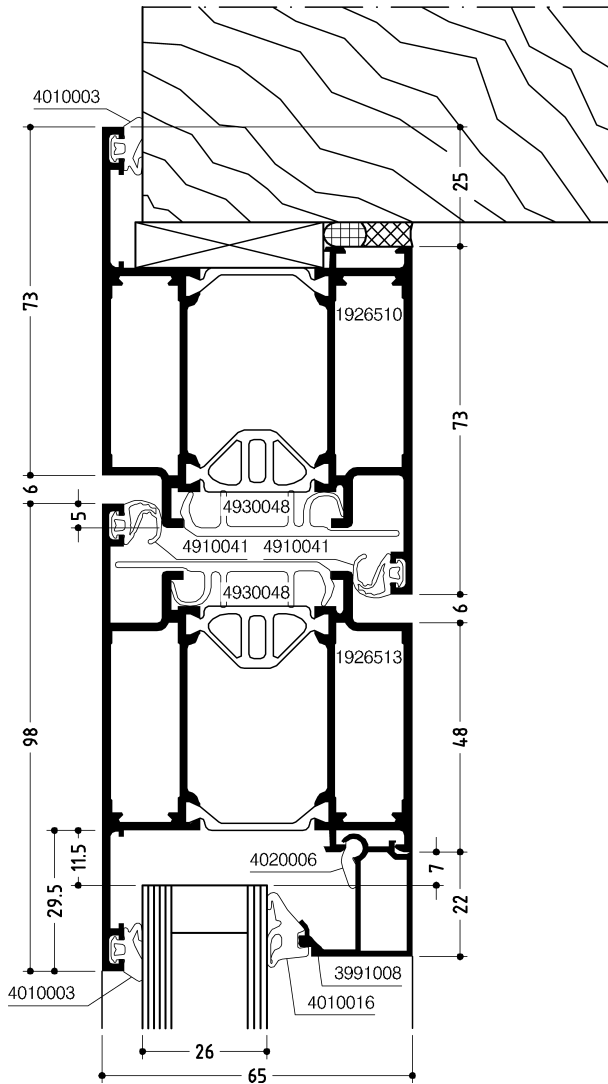

DOC-0001019272

Anschlagtüren
auswärts mit Spezi-
alblendrahmen

*Hinged doors
outwards with
special frame*

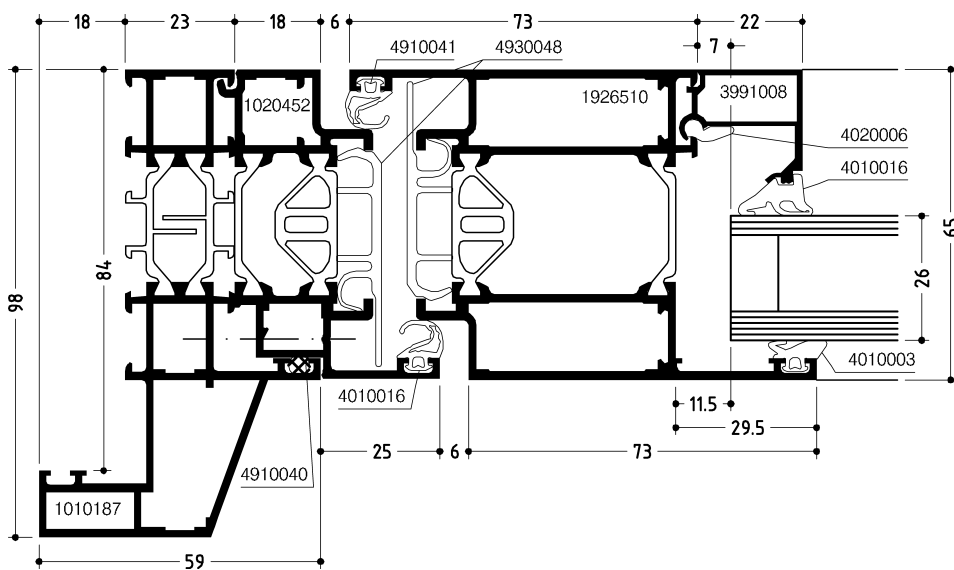

DOC-0000910211

Anschlagtür
einwärts mit Kombi-
nationsblendrah-
men

*Hinged door
inwards with
combination frame*

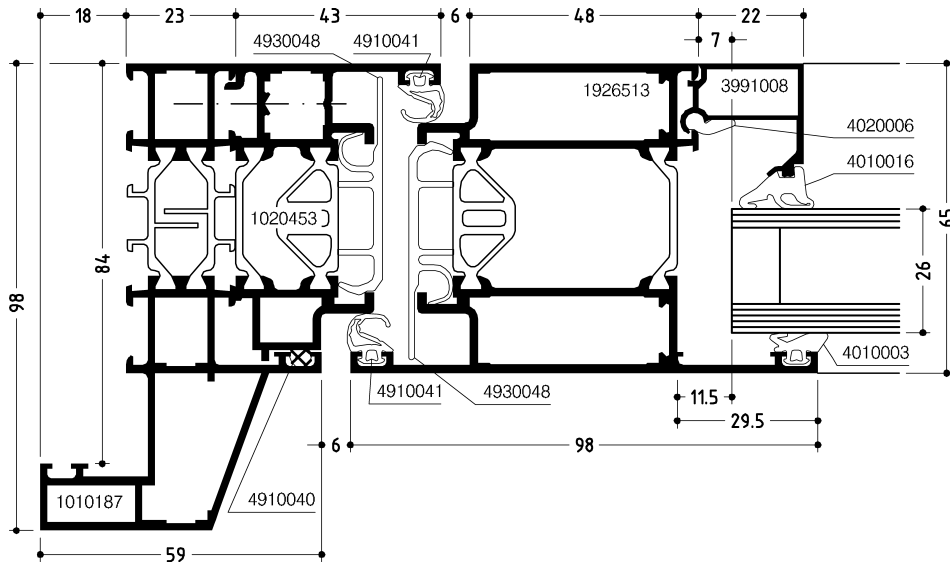

DOC-0000910093

Anschlagtür
auswärts mit
Kombinations-
blendrahmen
*Hinged door
outwards with
combination frame*

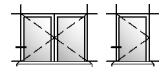
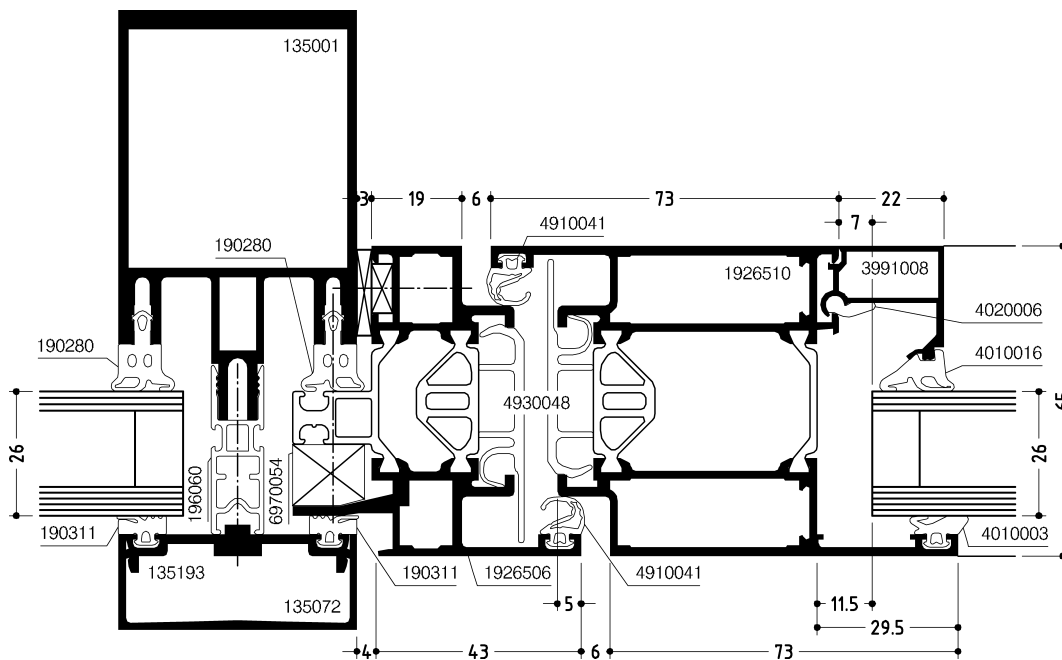

DOC-0000677424

Anschlagtüren
einwärts mit
Einspannblendrah-
men, kombiniert mit
WICTEC 50
*Hinged doors
inwards with
clamping frame
profile combined
with WICTEC 50*

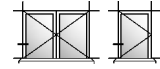
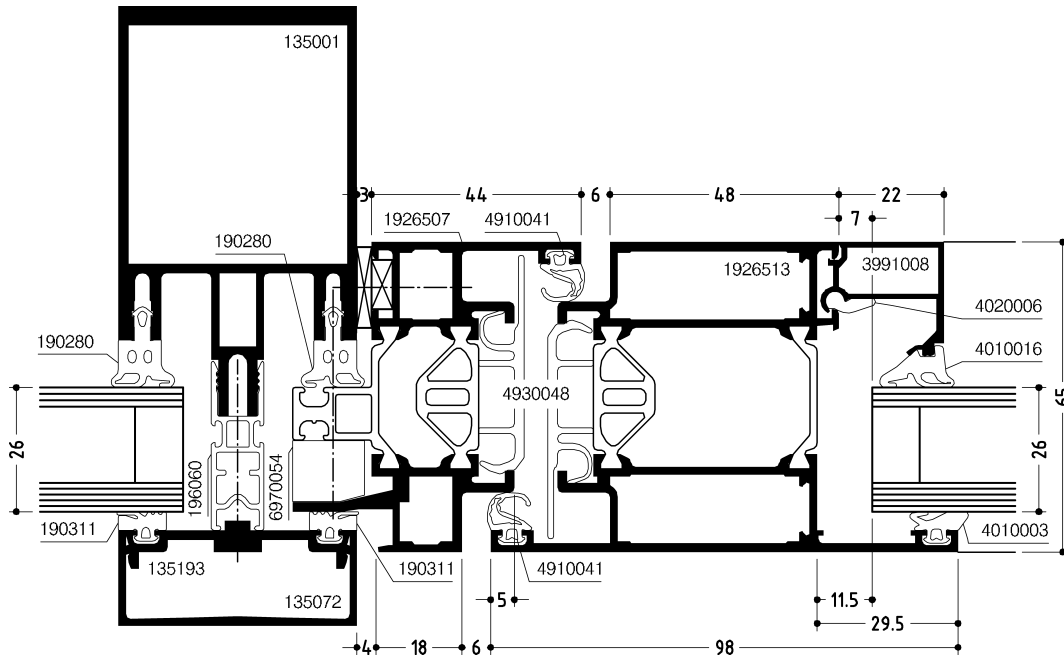

DOC-0000677488

Anschlagtüren
auswärts mit
Einspannblendrah-
men, kombiniert
mit WICTEC 50

*Hinged doors
outwards with
clamping frame
profile combined
with WICTEC 50*

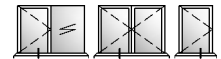
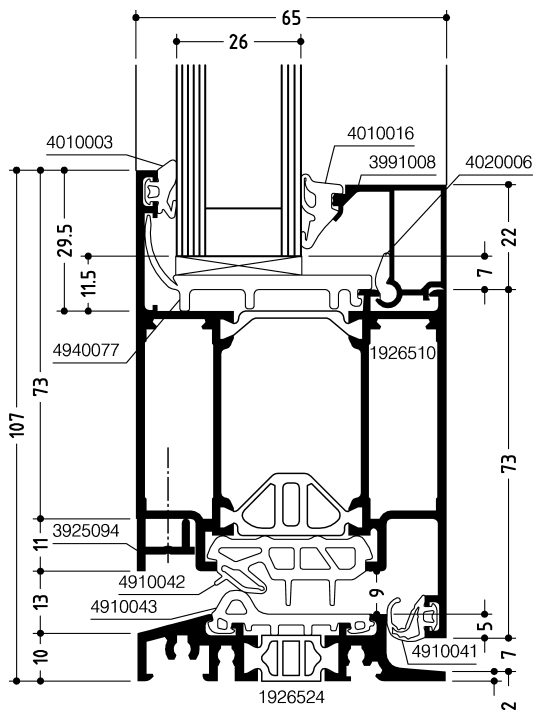

DOC-0000640203

Anschlagtüren
einwärts mit Flügel-
profil umlaufend

*Hinged doors
inwards with
circumferential leaf
profile*

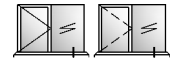
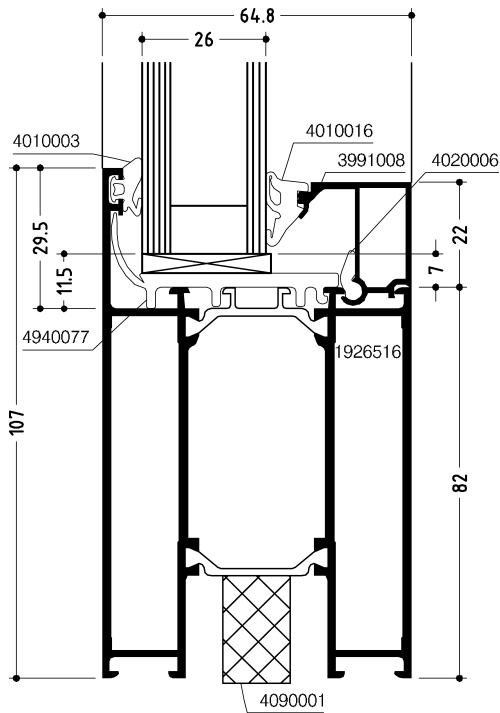

DOC-0000675872

Festfeld mit Sockel-
profil
*Fixed field with
bottom rail profile*

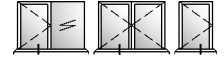
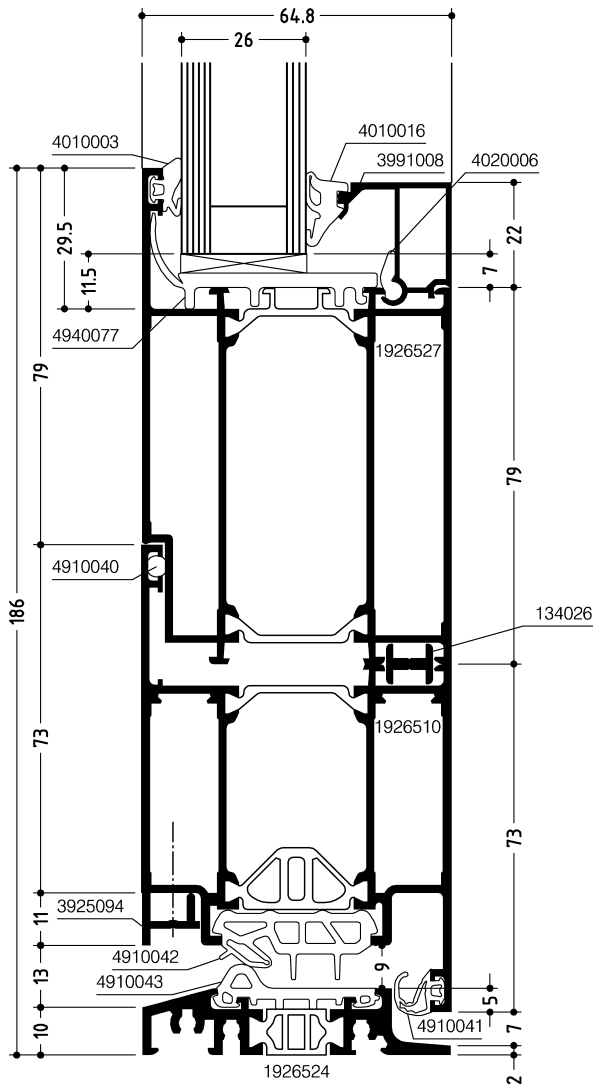

DOC-0000676482

Anschlagtüren
einwärts mit Flügel-
profil umlaufend
und Falzverbreite-
rungsprofil

*Hinged doors
inwards with
circumferential leaf
profile and rebate
widening profi*

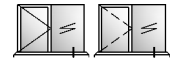
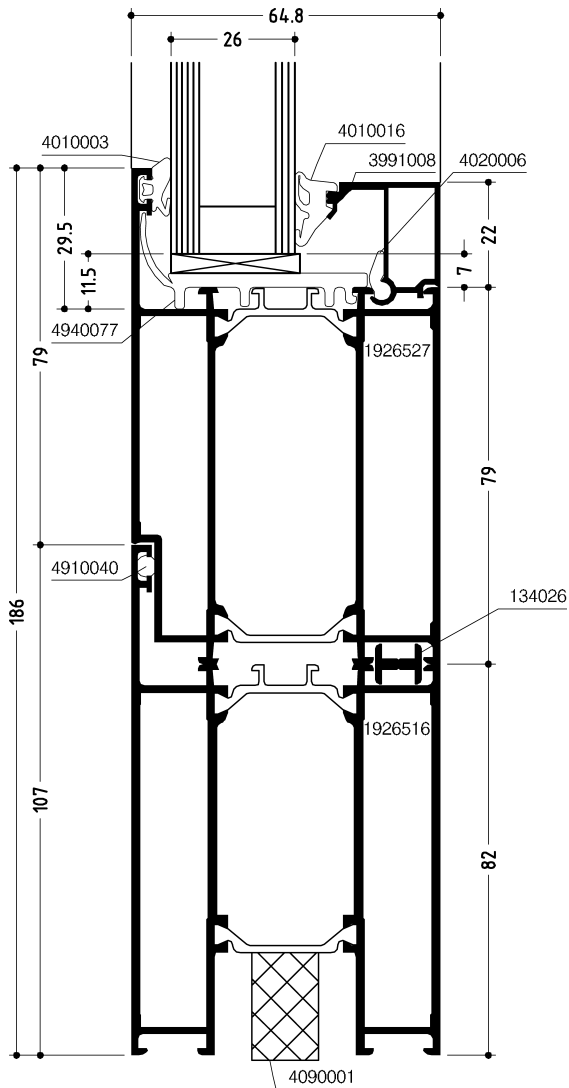

DOC-0000676484

Festfeld mit Sockel-
und Falzverbreite-
rungsprofil

*Fixed field with
bottom rail and
rebate widening
profile*

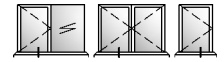
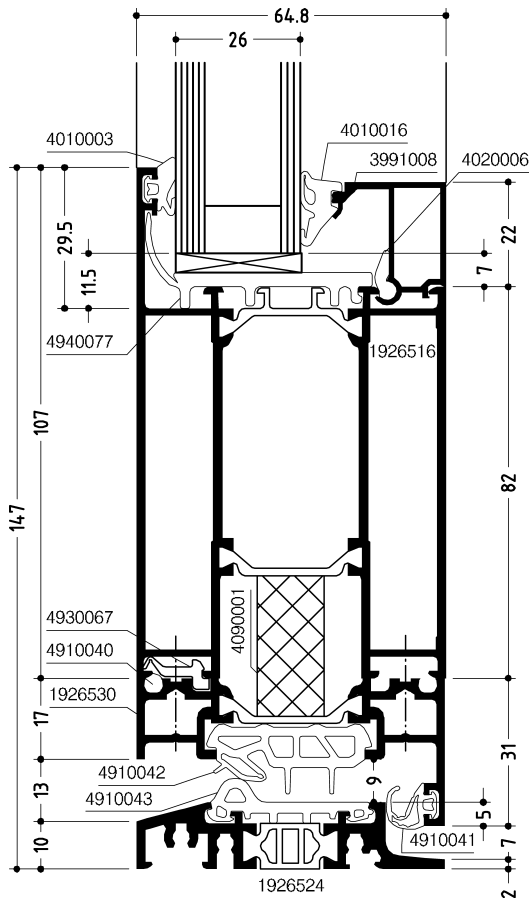

DOC-0000640811

Anschlagtüren
einwärts mit
Sockelprofil
*Hinged doors
inwards with
bottom rail profile*

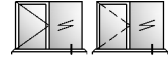
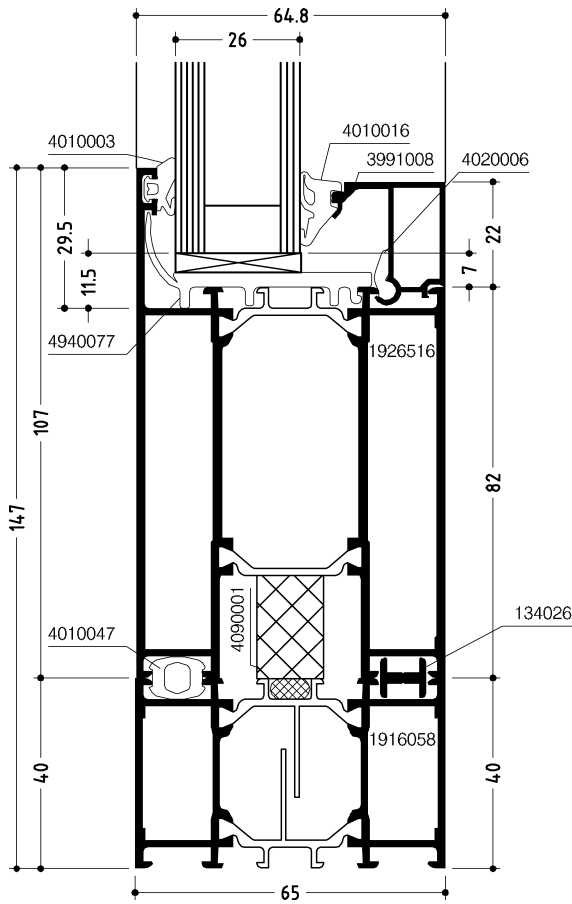

DOC-0000676184

Festfeld mit Sockel-
und Aufsatzprofil
*Fixed field with
bottom rail and
supplementary
profile*

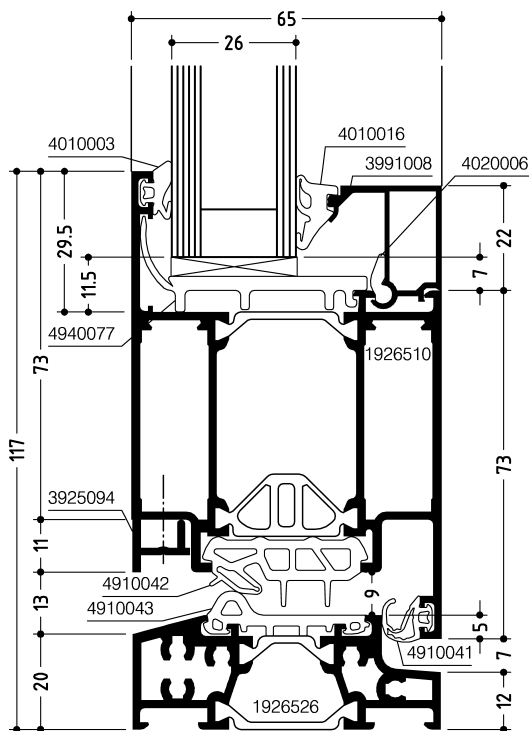

DOC-0000640004

Anschlagtüren
einwärts mit Flügel-
profil umlaufend
*Hinged doors
inwards with
circumferential leaf
profile*

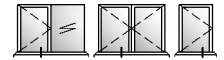
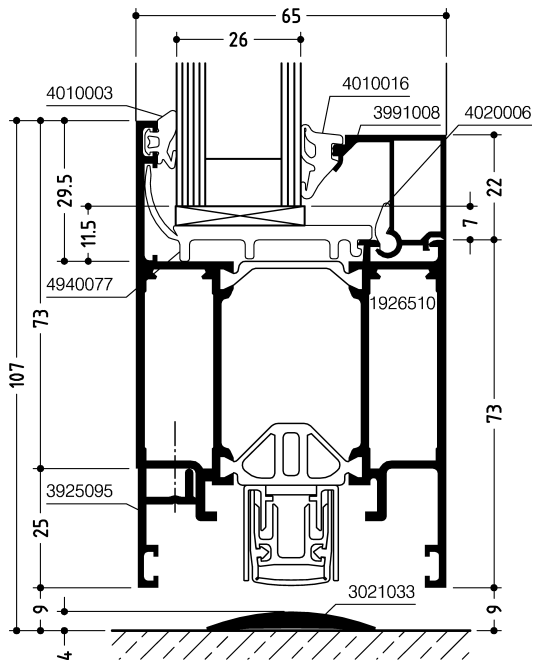

DOC-0000691000

Anschlagtüren
einwärts mit Flügel-
profil umlaufend
*Hinged doors
inwards with
circumferential leaf
profile*

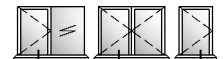
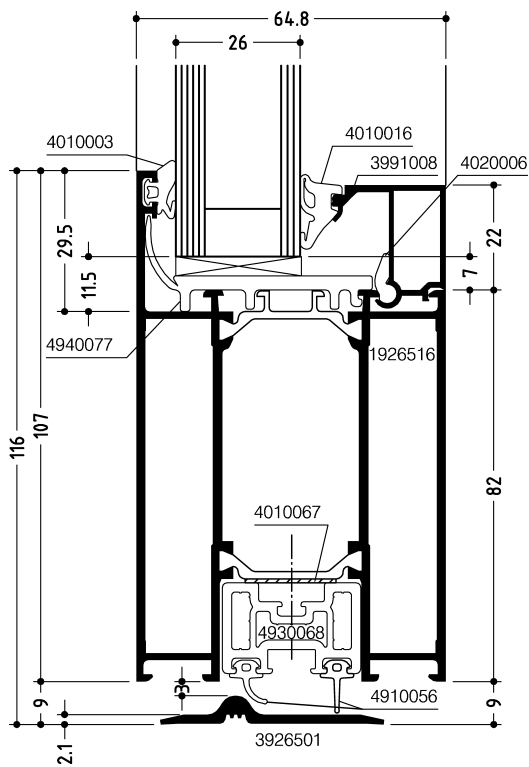

DOC-0000676589

Anschlagtüren
einwärts mit
Sockelprofil
*Hinged doors
inwards with
bottom rail profile*

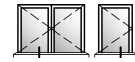
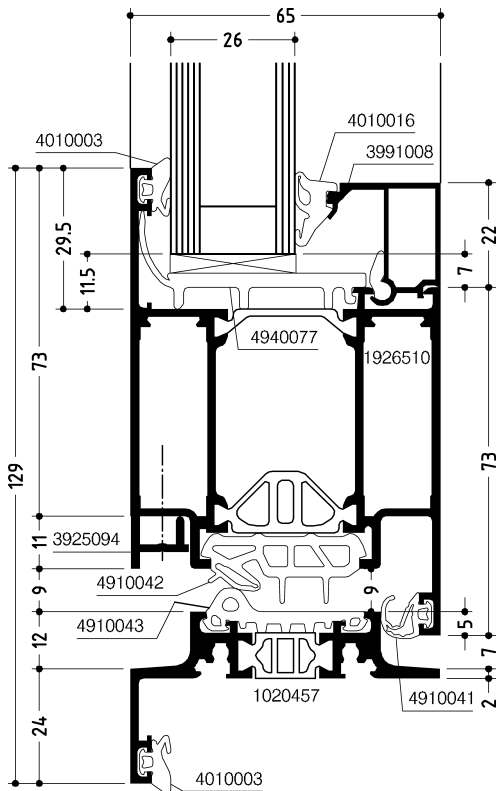

DOC-0000911876

Anschlagtüren
einwärts mit Flügel-
profil umlaufend

*Hinged doors
inwards with
circumferential leaf
profile*

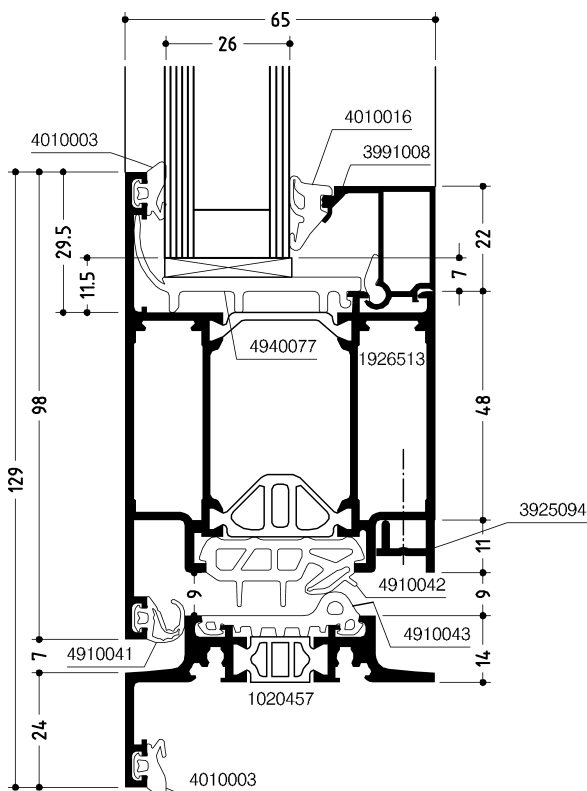

DOC-0000911854

Anschlagtüren
auswärts mit
Flügelprofil umlau-
fend

*Hinged doors
outwards with
circumferential leaf
profile*

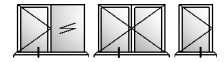
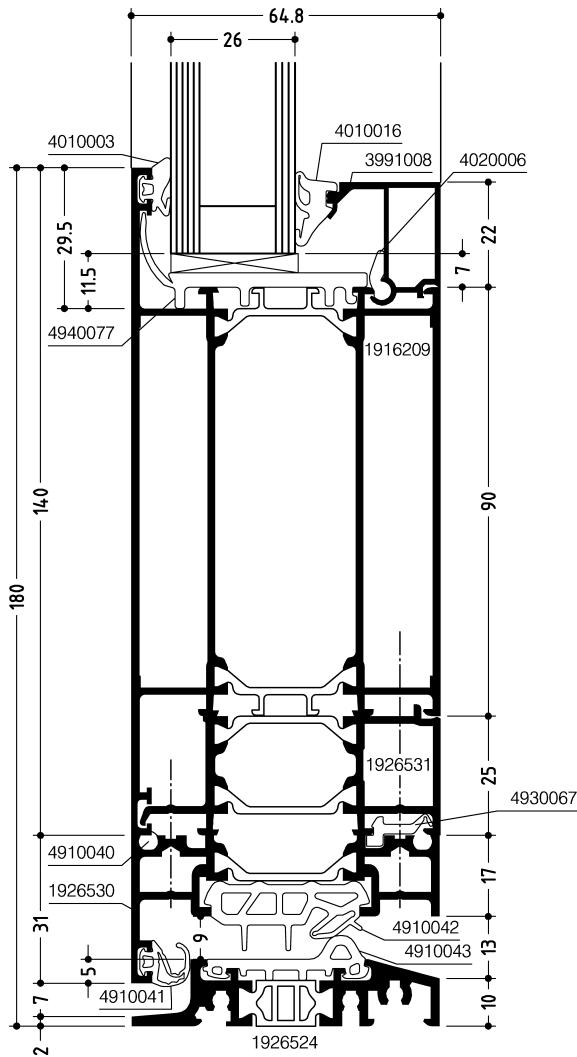

DOC-0000676337

Anschlagtüren
auswärts mit
Kämpfer- und
Aufsatzprofil als
Kämpfersockel
*Hinged doors
outwards with
transom as
bottom rail and
supplementary
profile*

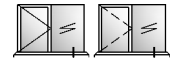
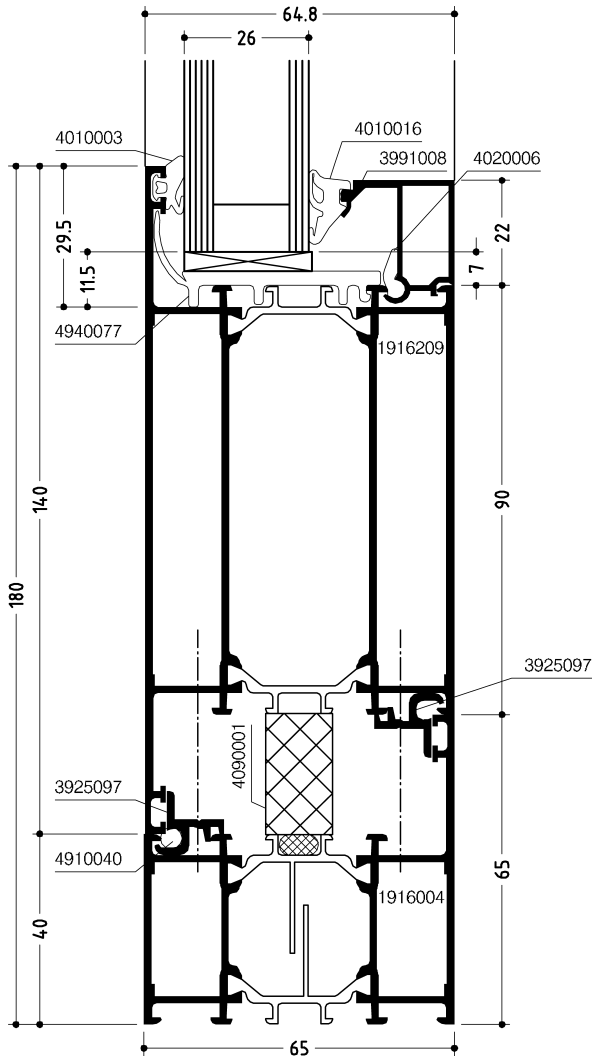

DOC-0000676345

Festfeld mit Kämpfersockel und
Blendrahmenprofil
*Fixed field with
transom as bottom
rail and frame
profile*

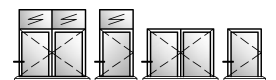
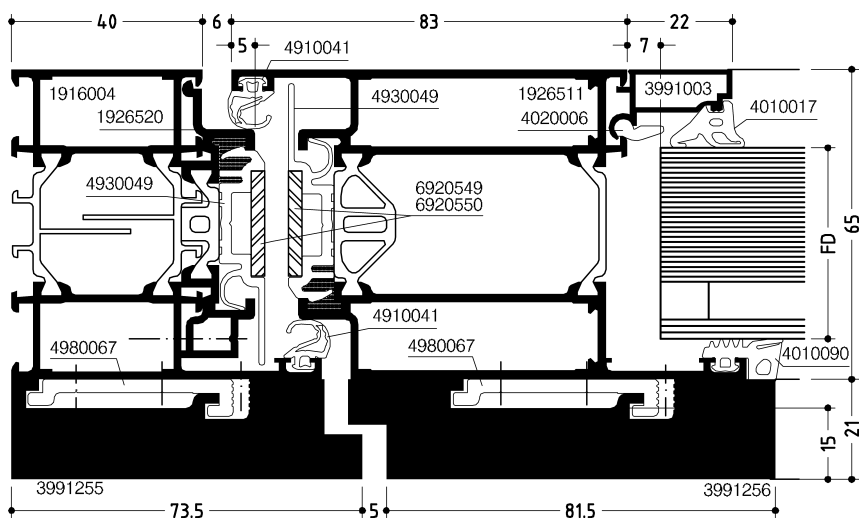

DOC-0000784828

Anschlagtüren
einwärts mit Kombi-
nationsblendrah-
men, Stulptüren
*Hinged doors
inwards with
combination
frame, double casement
door*

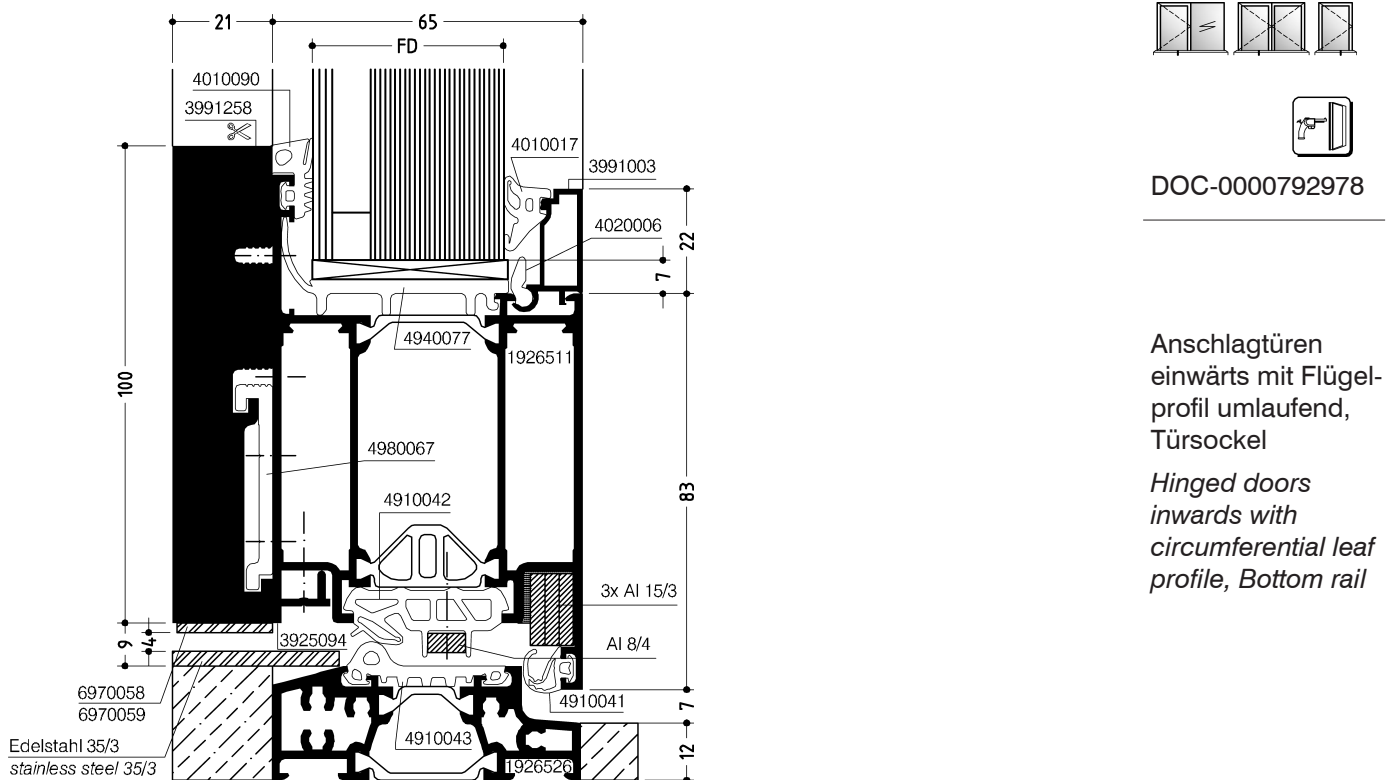
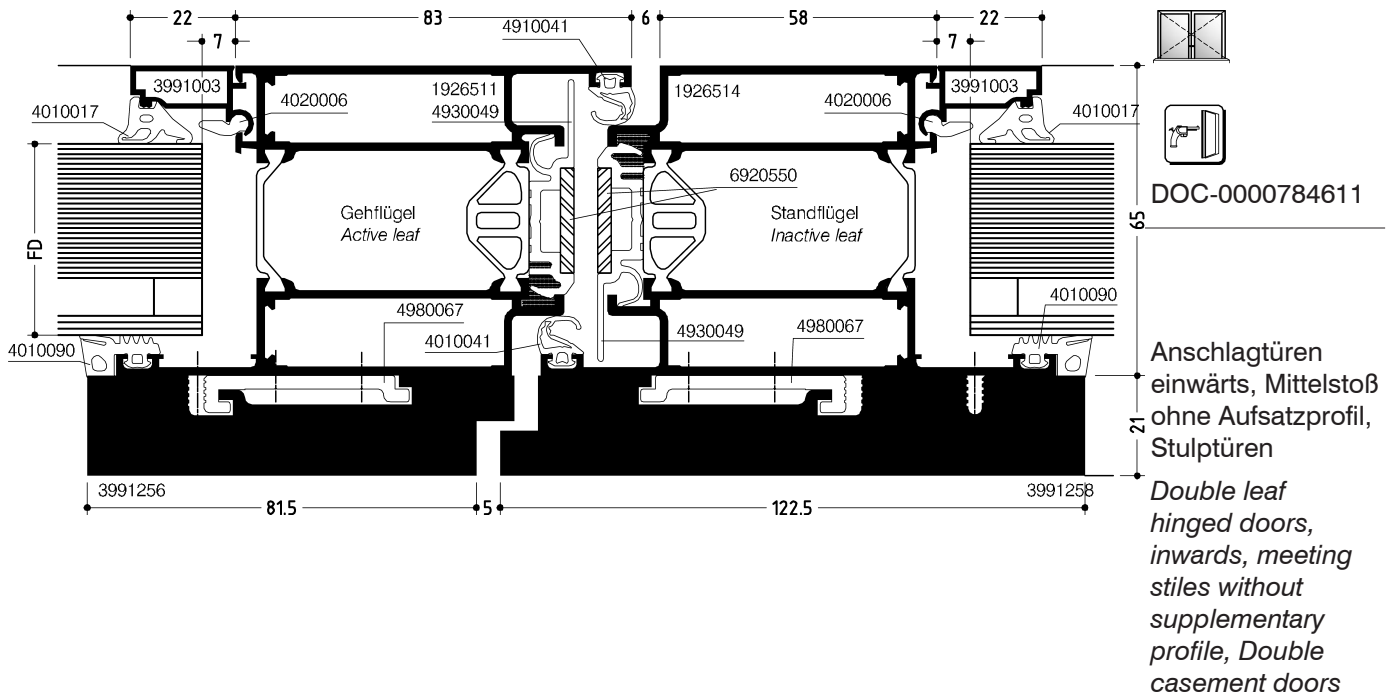

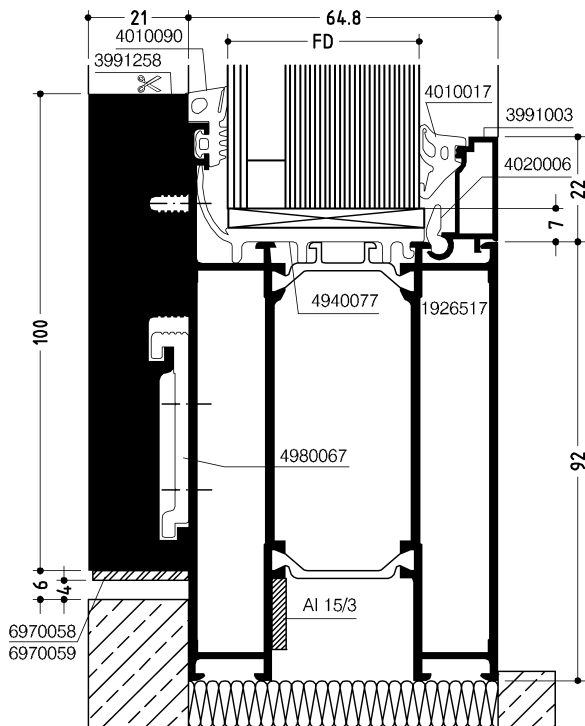

DOC-0000793062

Anschlagtüren
einwärts mit Flügel-
profil umlaufend

*Hinged doors
inwards with
circumferential leaf
profile, Bottom rail*

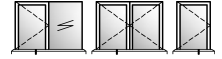
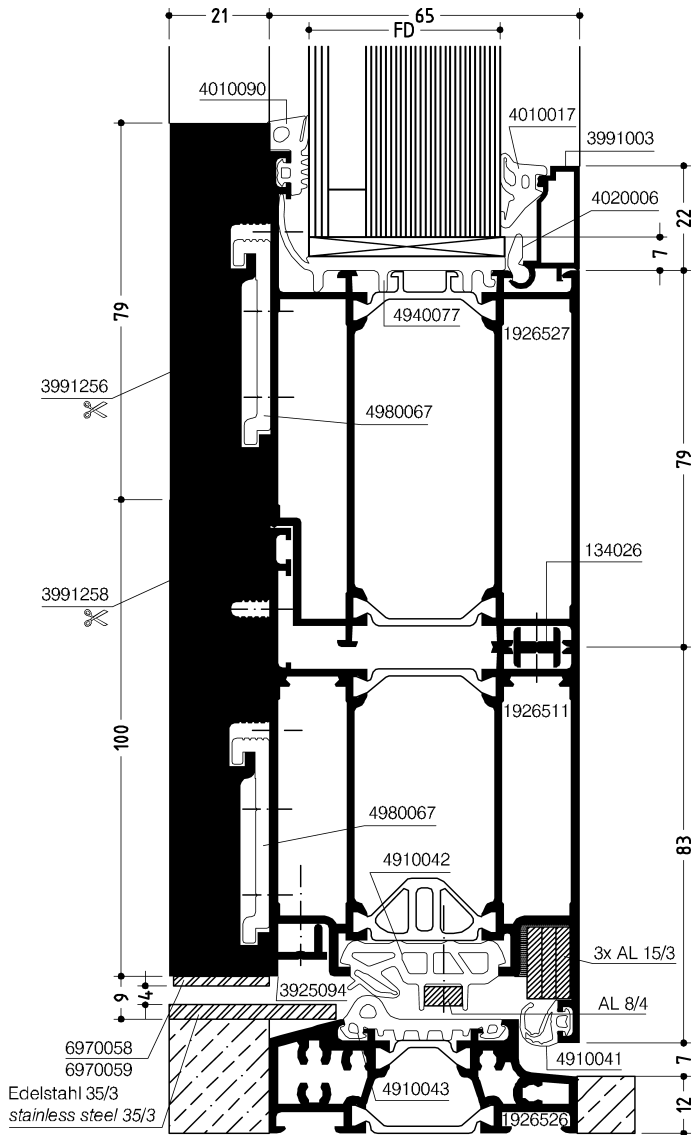

DOC-0000849789

Anschlagtüren
einwärts mit Flügel-
profil umlaufend,
Türsockel

*Hinged doors
inwards with
circumferential leaf
profile, Bottom rail*

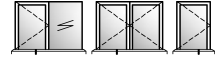
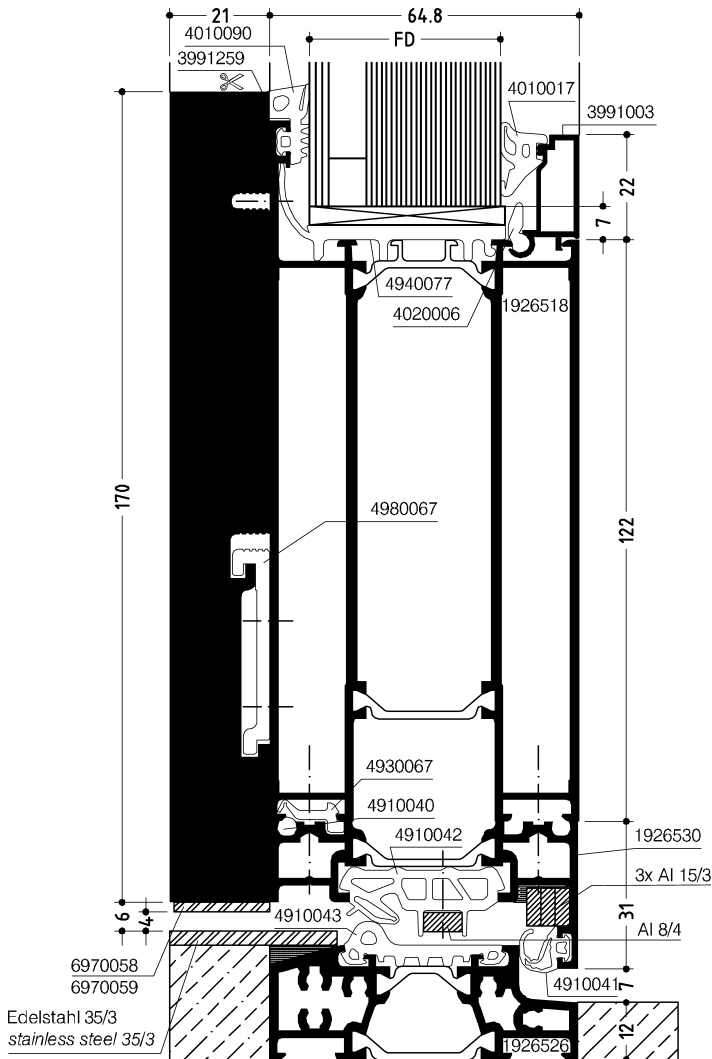

DOC-0000792877

Anschlagtüren
einwärts mit
Sockelprofil, Türso-
ckel

*Hinged doors
inwards with
bottom rail profile,
Bottom rail*

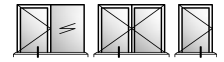
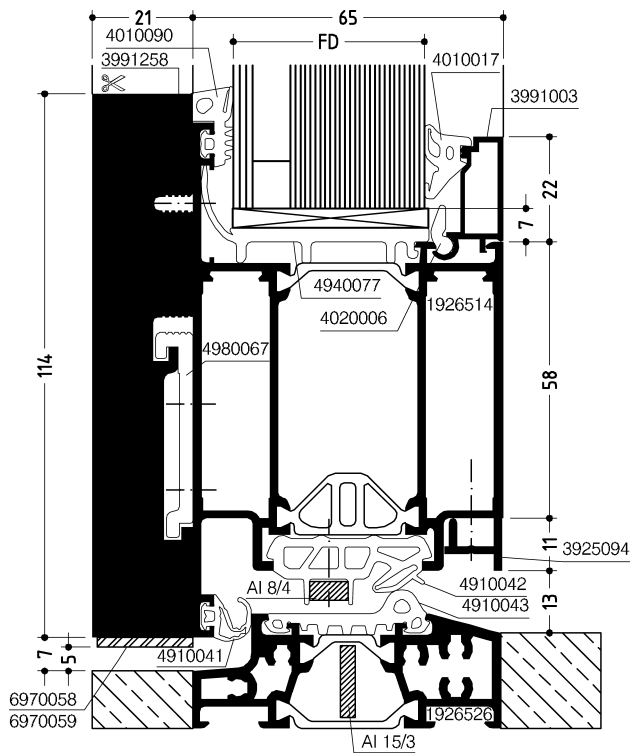

DOC-0000789017

Anschlagtüren
auswärts mit
Flügelprofil umlau-
fend, Türsockel

*Hinged doors
outwards with
circumferential leaf
profile, Bottom rail*

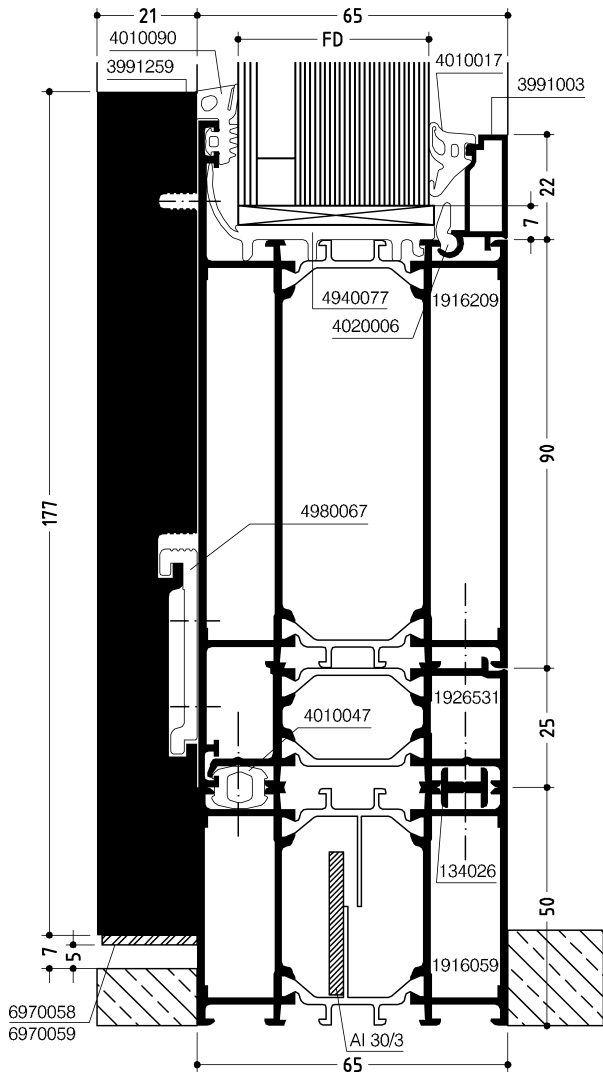

DOC-0000787729

Anschlagtüren
auswärts mit
Kämpferprofil, Fest-
feldsockel

*Hinged doors
outwards with
transom profile,
Fixed field bottom
rail*

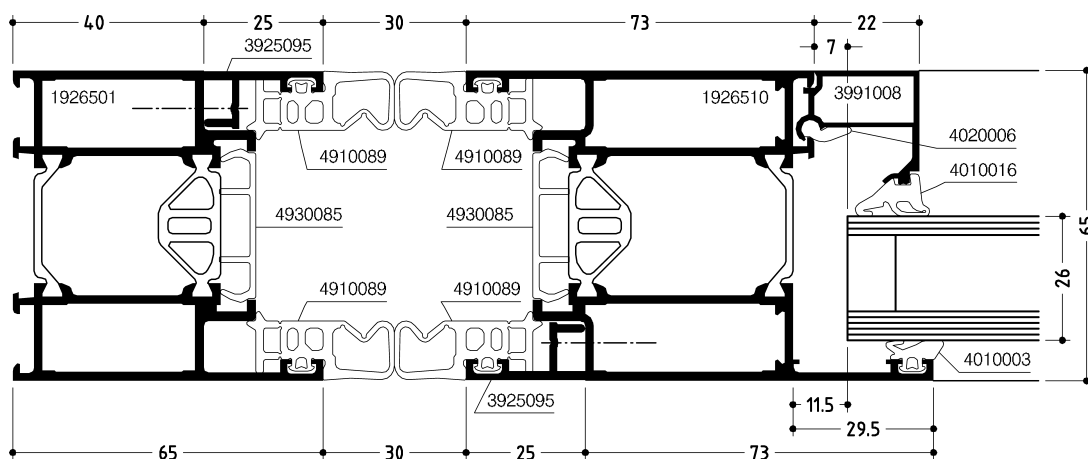

DOC-0000819455

Fingerschutztüren
einwärts mit Spezi-
alblendrahmen

*Door with finger
protection gaskets
inwards with
special frame*

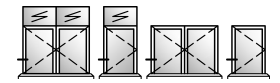
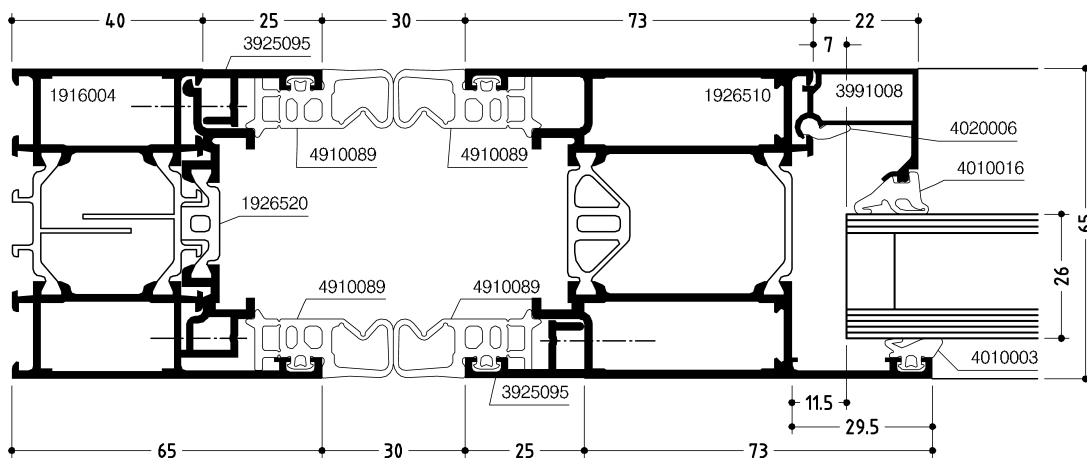

DOC-0000819554

Fingerschutztüren
einwärts mit Kombi-
nationsblendrah-
men

*Door with finger
protection gaskets
inwards with
combination frame*

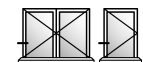
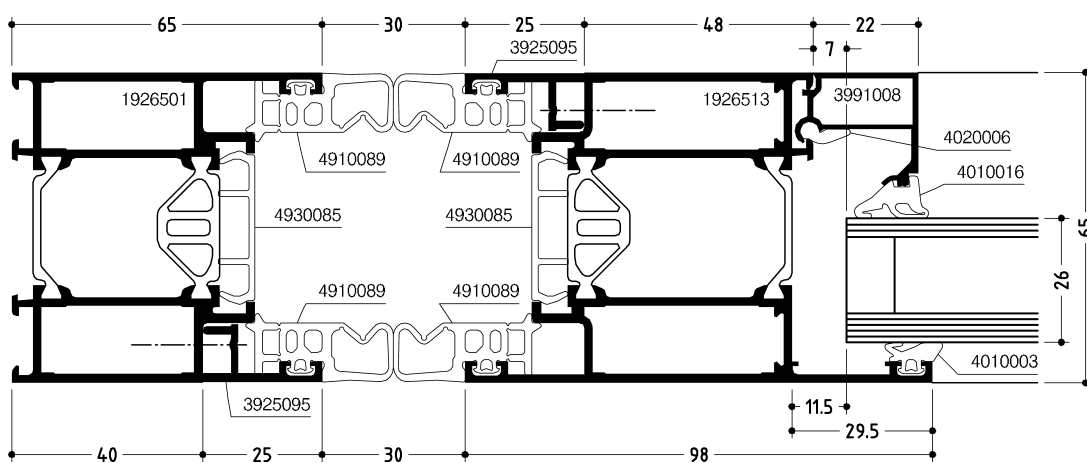

DOC-0000819523

Fingerschutztüren
auswärts mit Spezi-
alblendrahmen

*Door with finger
protection gaskets
outwards with
special frame*

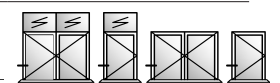
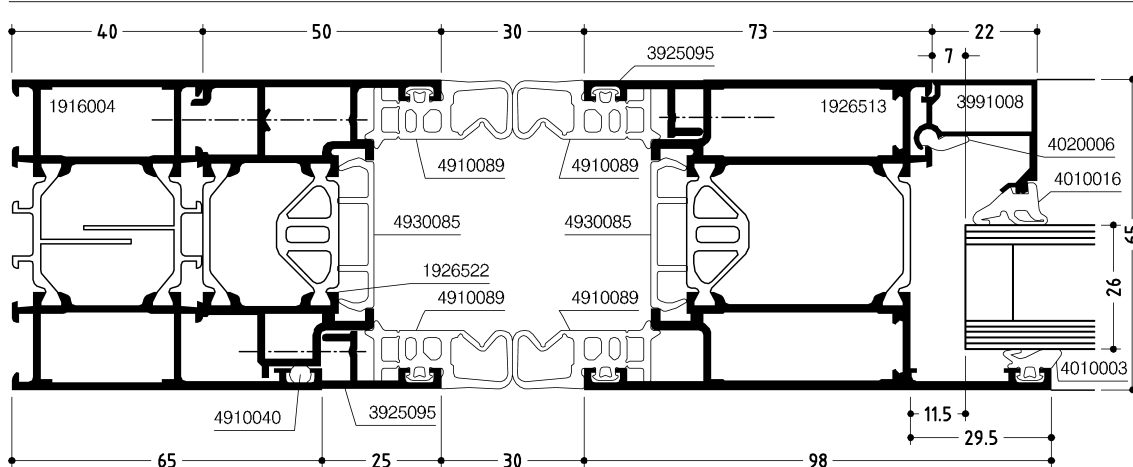

DOC-0000819608

Fingerschutztü-
ren auswärts mit
Kombinations-
blendrahmen

*Door with finger
protection gaskets
outwards with
combination frame*

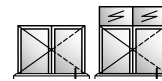
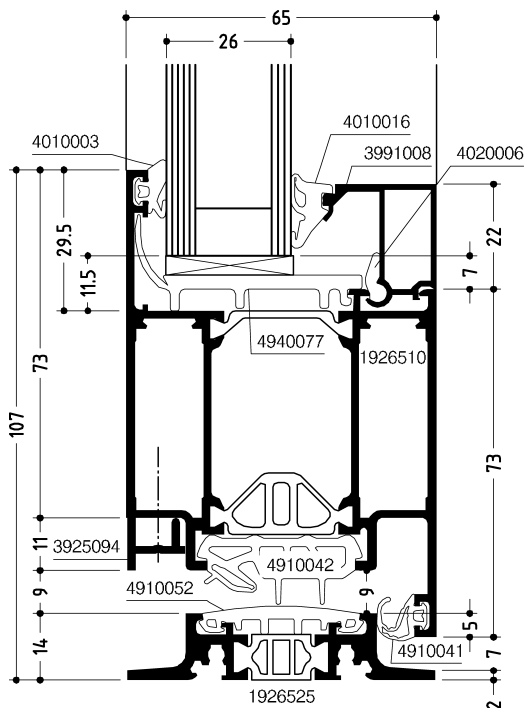

DOC-0000855315

Gegentaktüren
Flügel einwärts mit
Flügelprofil umlauf-
fend

*Push-pull doors
leaf inwards with
circumferential leaf
profile*

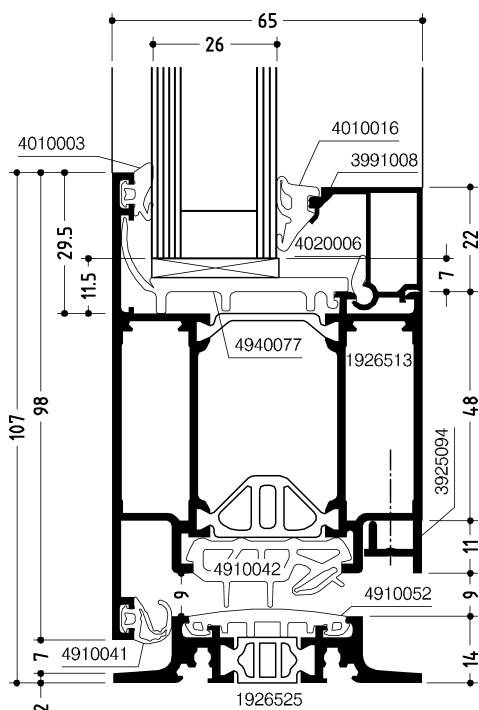

DOC-0000857528

Gegentaktüren
Flügel auswärts mit
Flügelprofil umlauf-
fend

*Push-pull doors
leaf outwards with
circumferential leaf
profile*

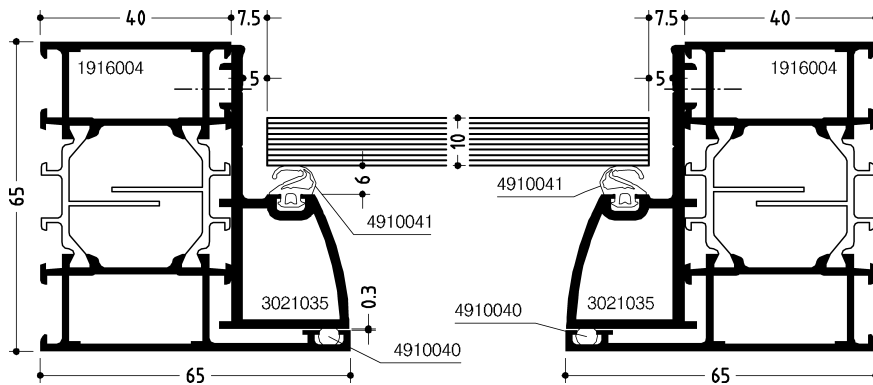

DOC-0000819008

Ganzglastüren
All-glass doors

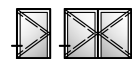
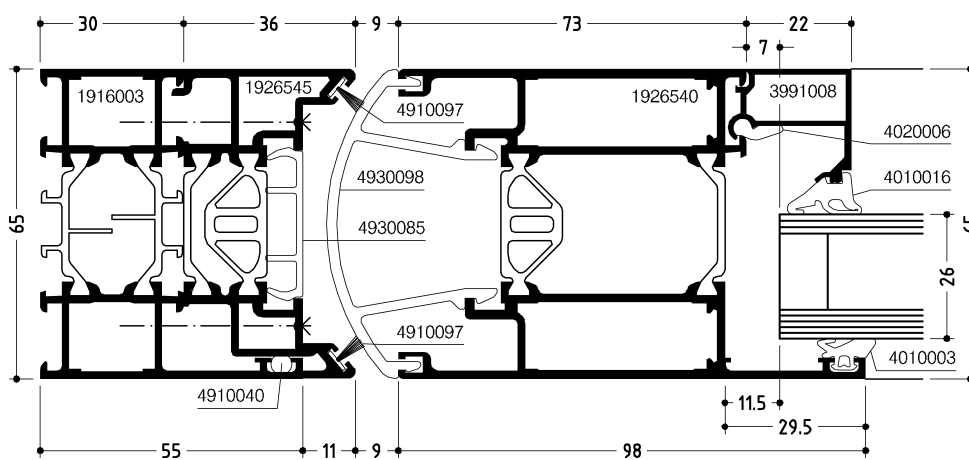

DOC-0000843618

Pendeltüren
passend für integ-
rierten Türschließer
*Double action
doors suitable for
integrated door
closer*

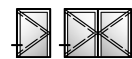
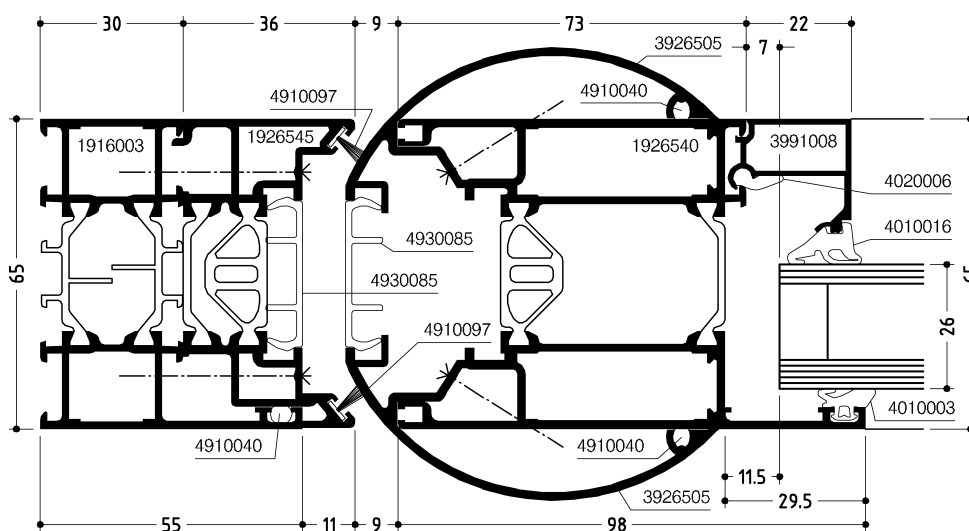

DOC-0000851422

Pendeltüren
passend für integ-
rierten Türschließer
*Double action
doors suitable for
integrated door
closer*

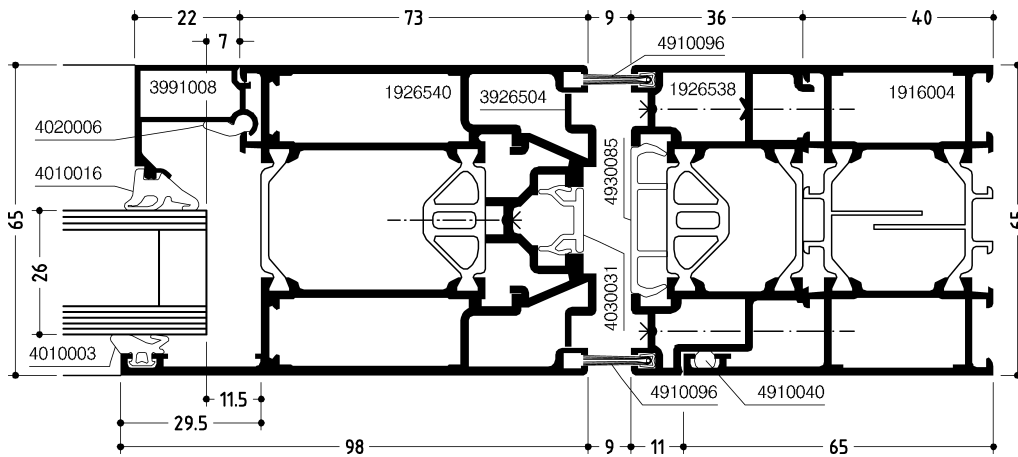

DOC-0000845119

Pendeltüren
passend für integ-
rierten Türschließer
*Double action
doors suitable for
integrated door
closer*

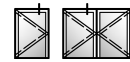
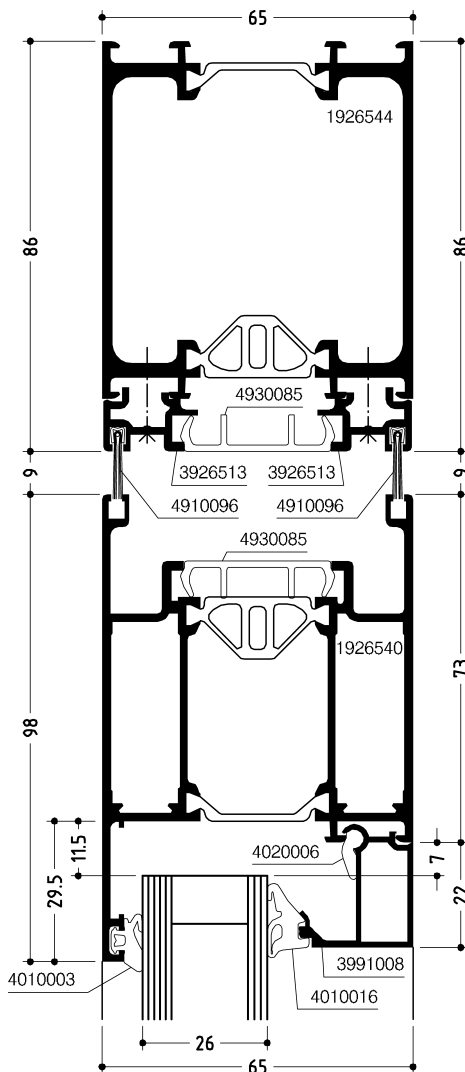

DOC-0000845642

Pendeltüren
passend für integ-
rierten Türschließer
*Double action
doors suitable for
integrated door
closer*

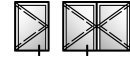
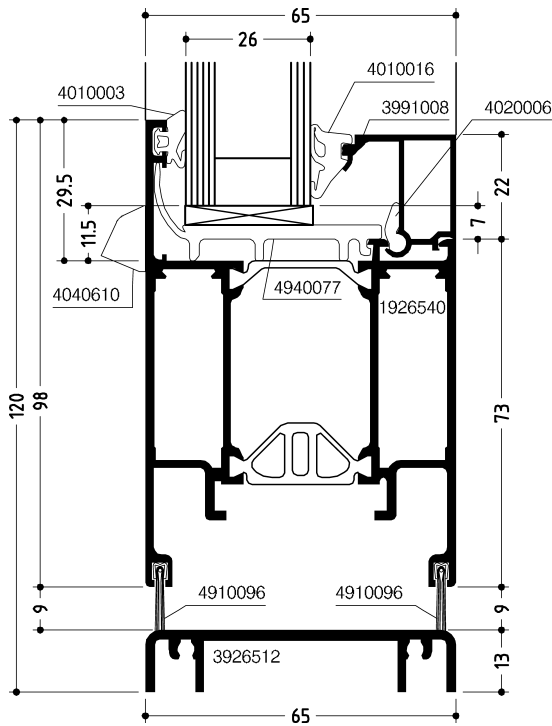

DOC-0000844418

Pendeltüren
passend für integ-
rierten Türschließer
*Double action
doors suitable for
integrated door
closer*

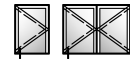
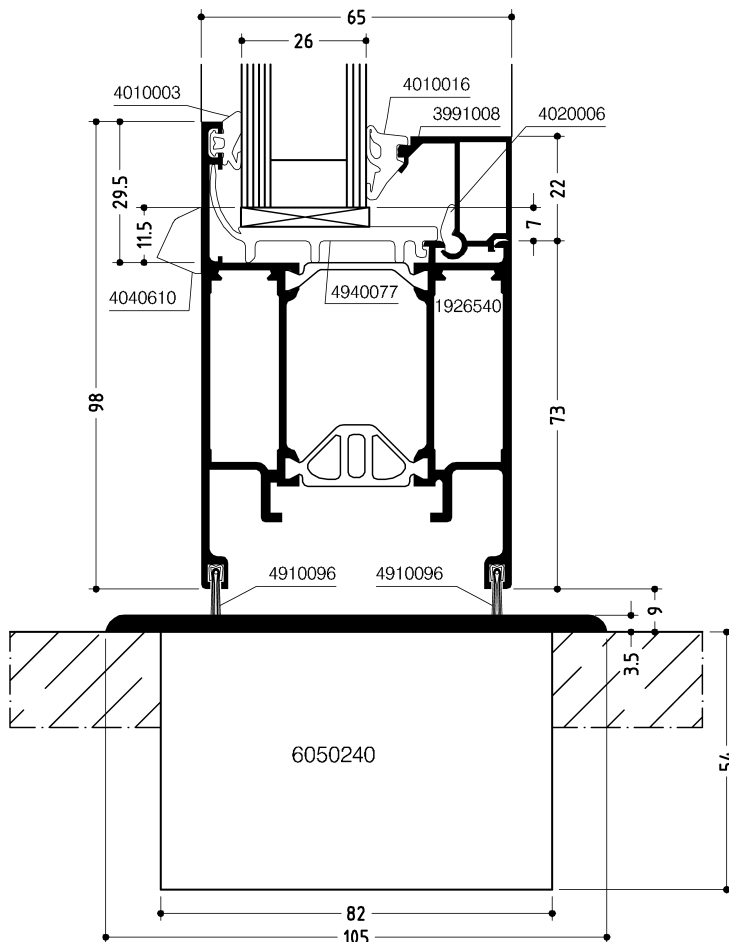

DOC-0000851863

Pendeltüren
passend nur für
Bodentürschließer
*Double action
doors suitable only
for floor door closer*

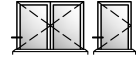
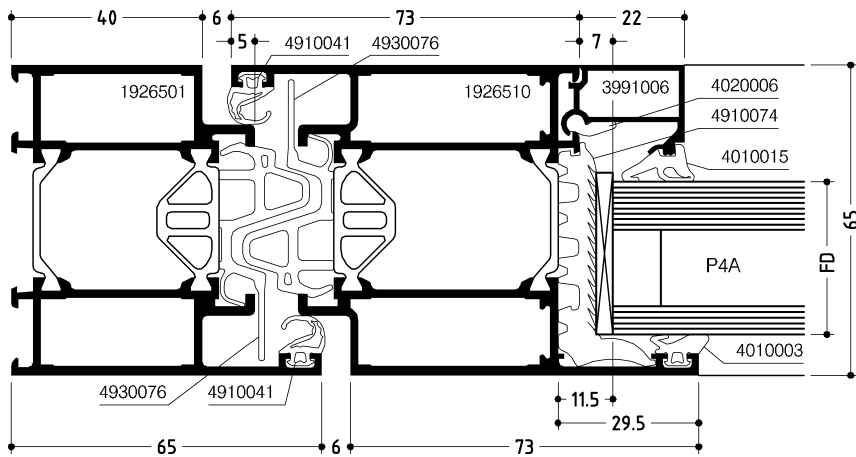

DOC-0000779235

Anschlagtüren
einwärts mit Spezi-
alblendrahmen
Bandsicherung /
Füllungssicherung

*Hinged doors
inwards with
special frame
Hinge sided
interlock / Infill
safeguard*

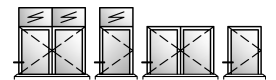
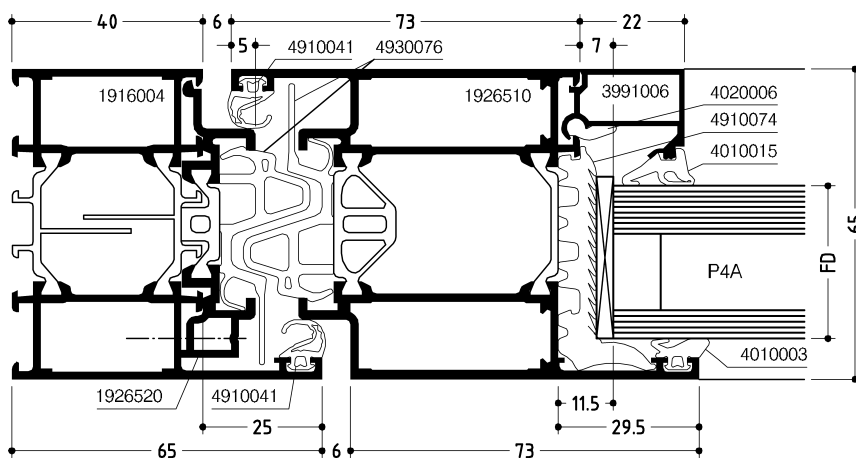

DOC-0000779247

Anschlagtüren
einwärts mit
Kombinations-
blendrahmen
Bandsicherung /
Füllungssicherung

*Hinged doors
inwards with
combination
frame Hinge sided
interlock / Infill
safeguard*

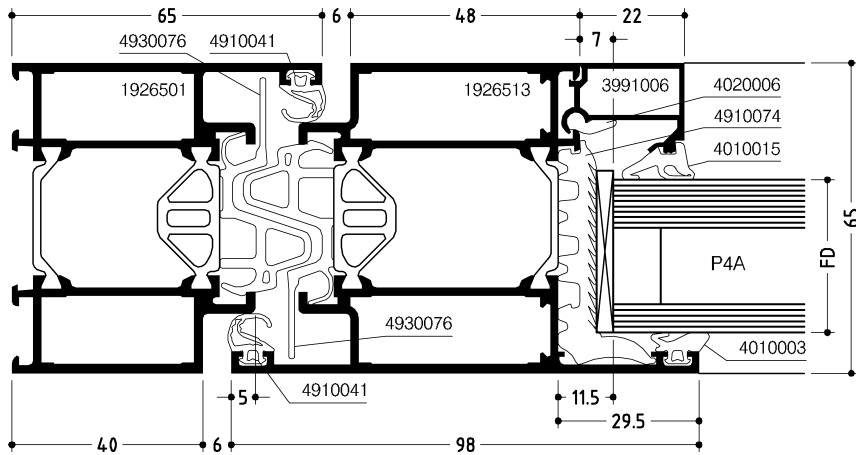

DOC-0000779258

Anschlagtüren
auswärts mit Spezi-
alblendrahmen
Bandsicherung /
Füllungssicherung

*Hinged doors
outwards with
special frame
Hinged sided
interlock / Infill
safeguard*

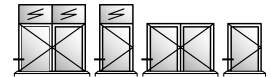
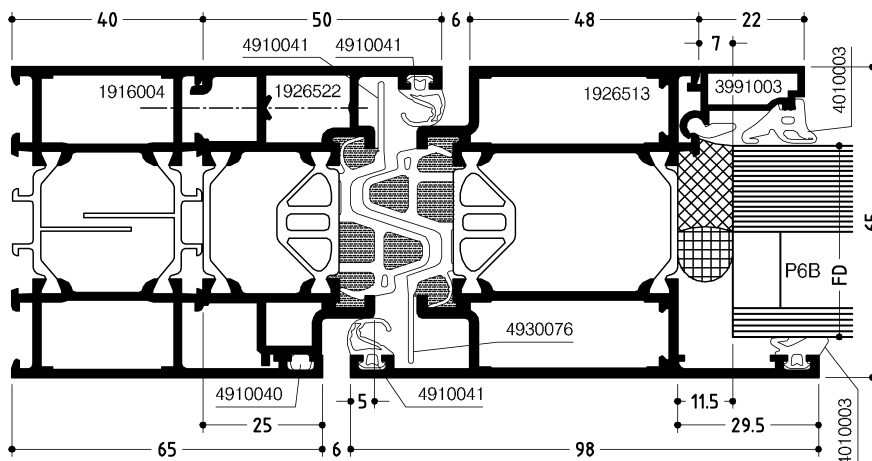

DOC-0000779272

Anschlagtüren
auswärts mit
Kombinations-
blendrahmen
Bandsicherung /
Füllungssicherung

*Hinged doors
outwards with
combination frame
Hinged sided
interlock / Infill
safeguard*

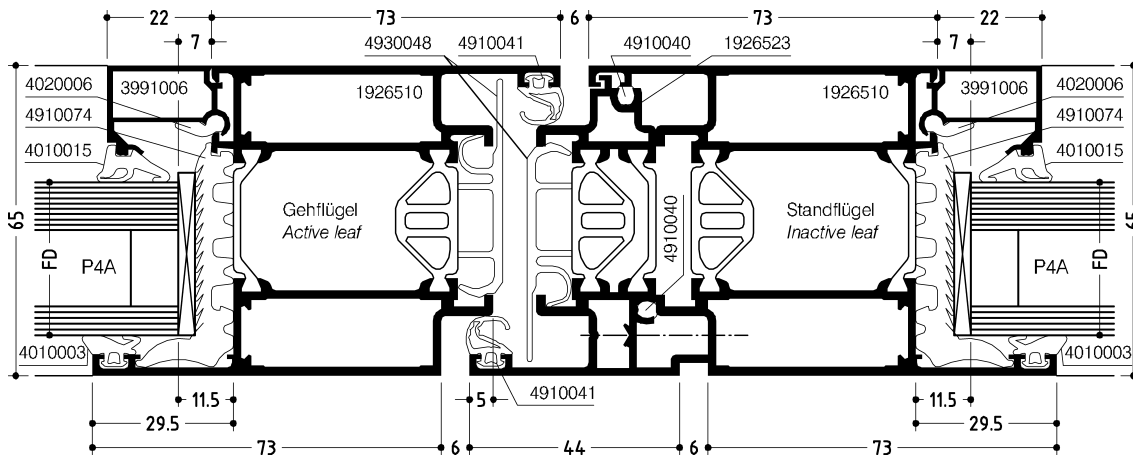

DOC-0000779322

Anschlagtüren
einwärts, Mittelstoß
mit Aufsatzprofil
Türfalz / Füllungssi-
cherung

*Hinged doors
inwards, meeting
stiles with
supplementary
profile Door rebate
/ Infill safeguard*

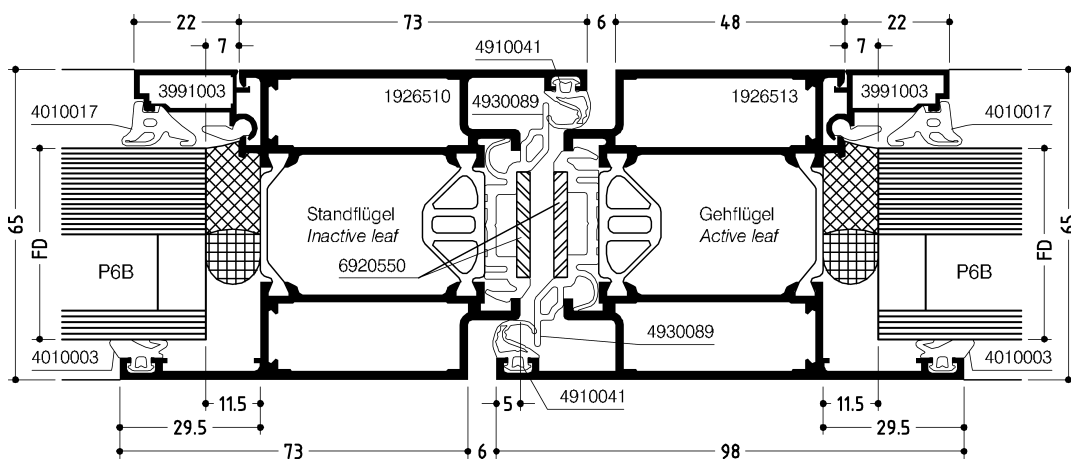

DOC-0000779294

Anschlagtüren
auswärts, Mittelstoß
ohne Aufsatzprofil
Türfalz / Füllungssi-
cherung

*Hinged doors
outwards, meeting
stiles without
supplementary
profile Door rebate
/ Infill safeguard*

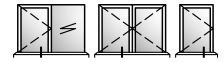
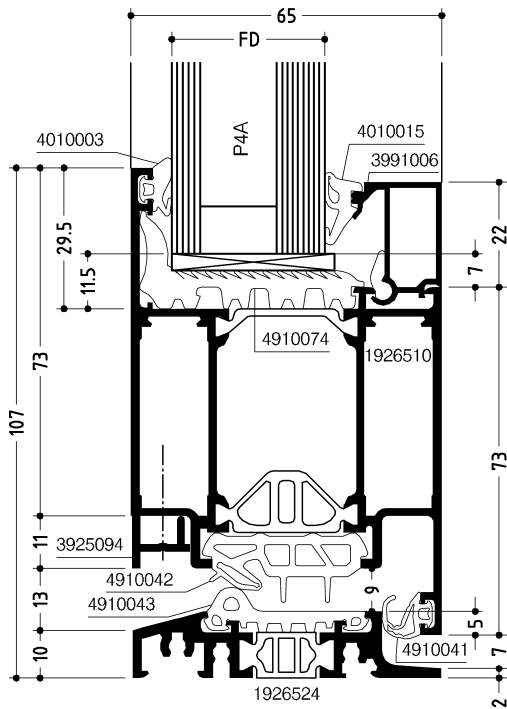

DOC-0000779338

Anschlagtüren
einwärts mit
Flügelprofil umlau-
fend Türsockel /
Füllungssicherung

*Hinged doors
inwards with
circumferential leaf
profile Bottom rail /
Infill safeguard*

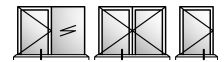
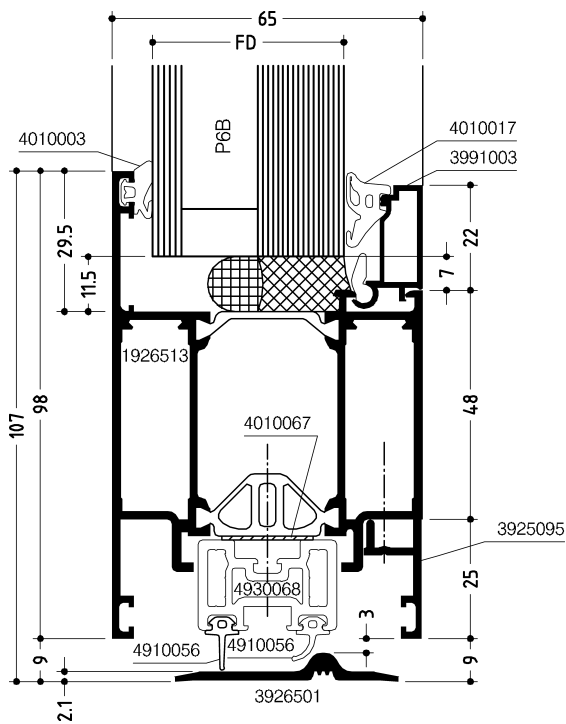

DOC-0000779392

Anschlagtüren
auswärts mit
Flügelprofil umlau-
fend Türsockel /
Füllungssicherung

*Hinged doors
outwards with
perimetric leaf
profile bottom rail /
Infill safeguard*

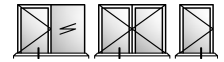
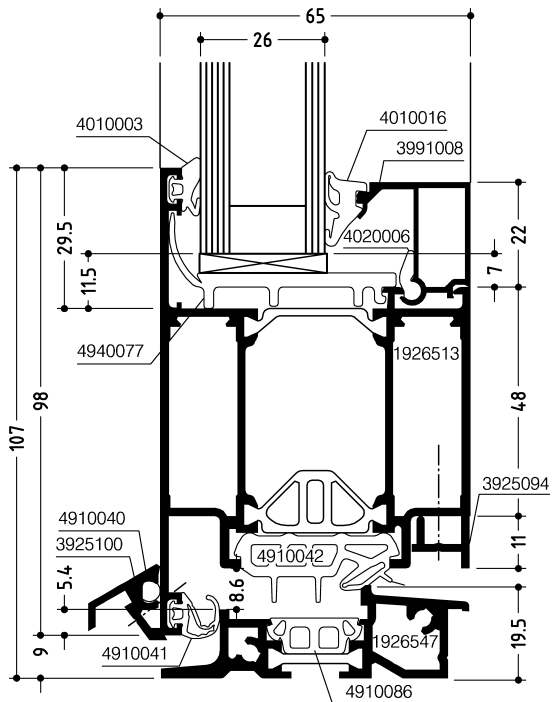

DOC-0000813939

Anschlagtüren
auswärts mit
Flügelprofil umlau-
fend

*Hinged doors
outwards with
circumferential leaf
profile*

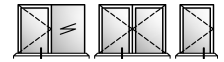
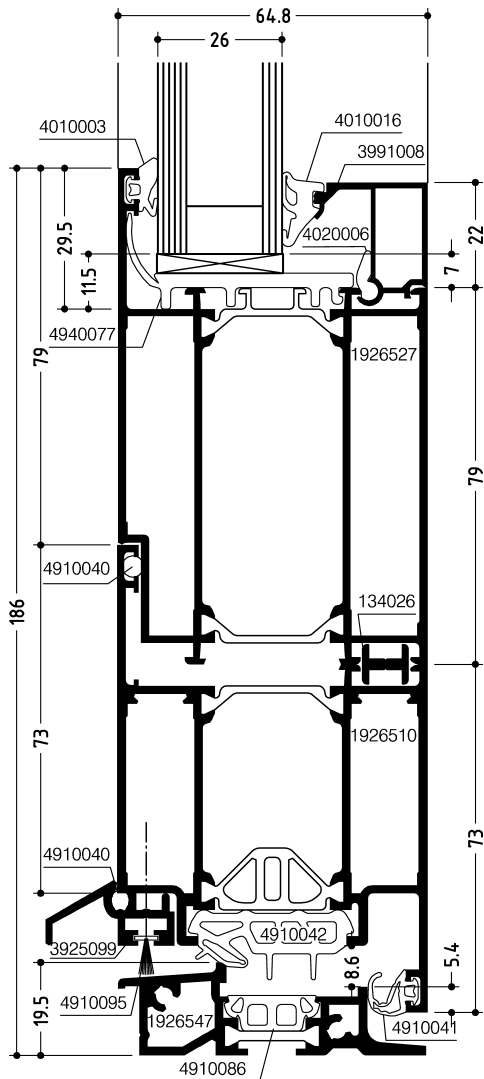

DOC-0000813945

Anschlagtüren
einwärts mit Flügel-
profil umlaufend
und Falzverbreite-
rung

*Hinged doors
inwards with
circumferential leaf
profile and rebate
widening profile*

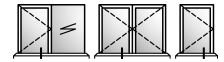
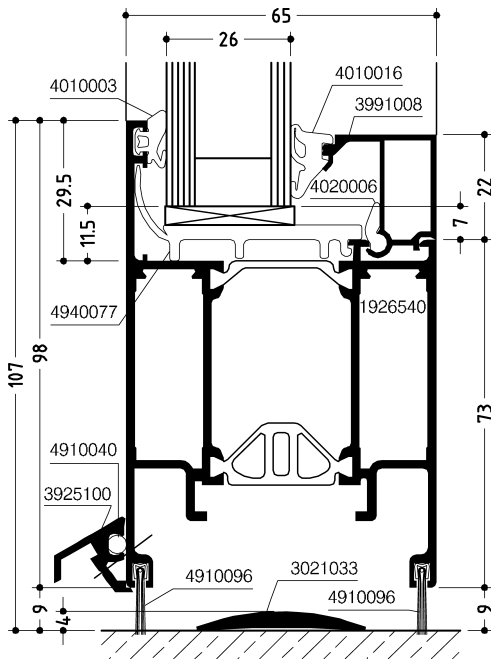

DOC-0000813948

Anschlagtüren
einwärts, auswärts
mit Flügelprofil
umlaufend

*Hinged doors
inwards, outwards
with circumferential
leaf profile*

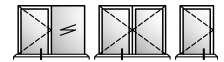
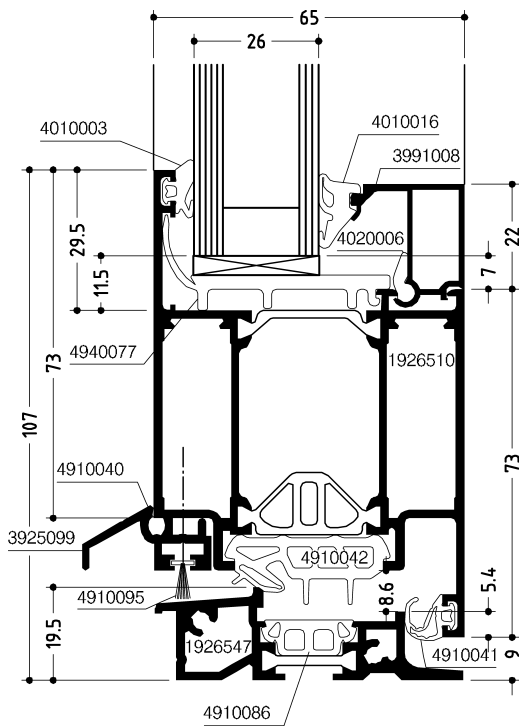

DOC-0000813906

Anschlagtüren
einwärts mit Flügel-
profil umlaufend

*Hinged doors
inwards with
circumferential leaf
profile*

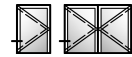
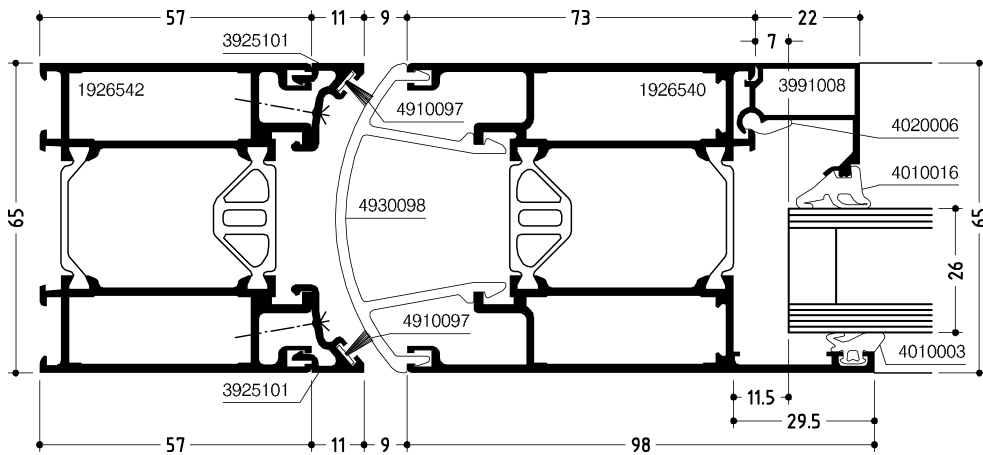

DOC-0000844328

Pendeltüren
passend nur für
Bodentürschließer
*Double action
doors suitable only
for floor mounted
door closer*

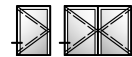
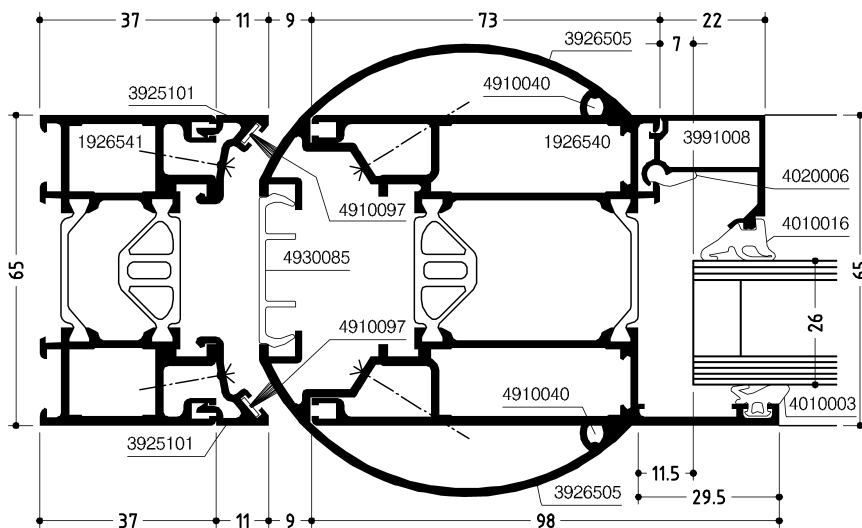

DOC-0000844329

Pendeltüren mit
Fingerschutz
passend nur für
Bodentürschließer
*Double action
doors with finger
protection suitable
only for floor
mounted door
closer*

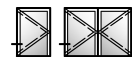
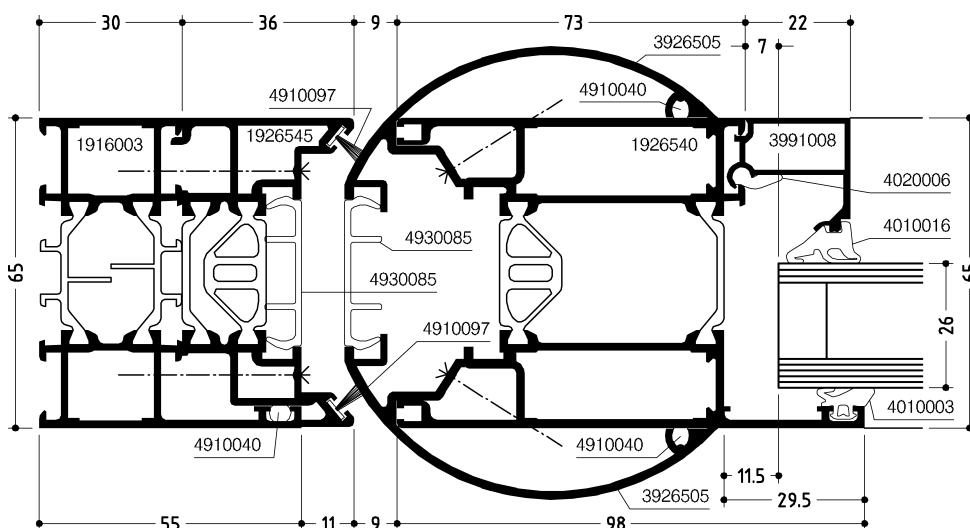

DOC-0000851422

Pendeltüren
passend für integ-
rierten Türschließer
*Double action
doors suitable for
integrated door
closer*

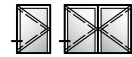
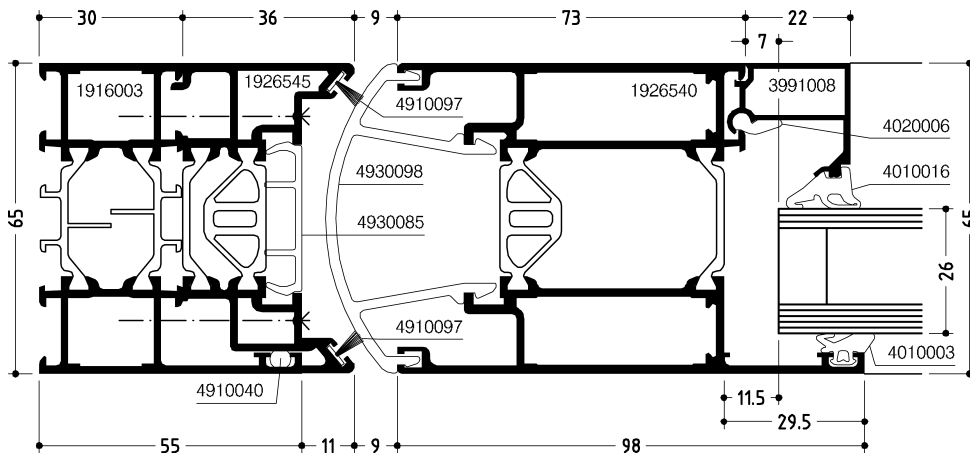

DOC-000843618

Pendeltüren
passend für integrier-
ten Türschließer
*Double action
doors suitable for
integrated door
closer*

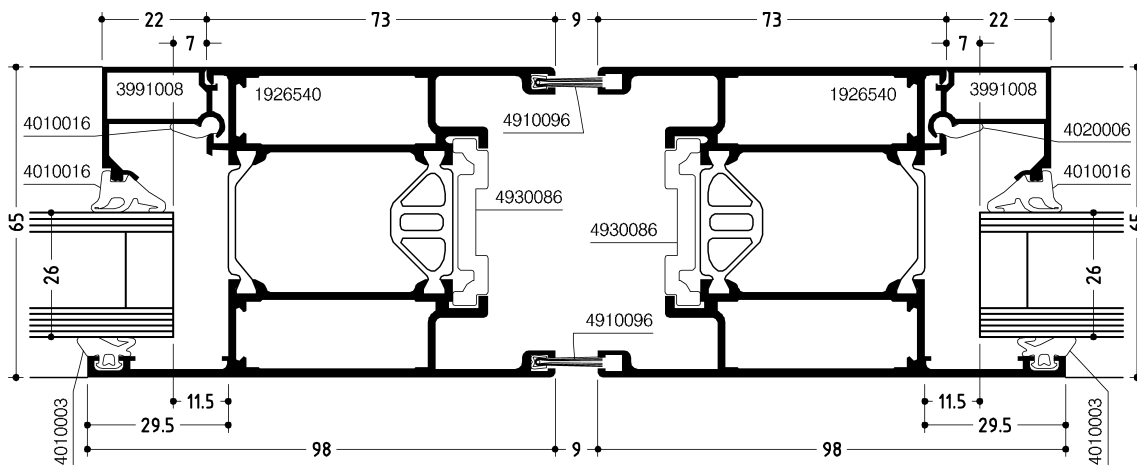

DOC-000851928

Pendeltüren -
Mittelstoß
*Double action
doors - Meeting
stiles*

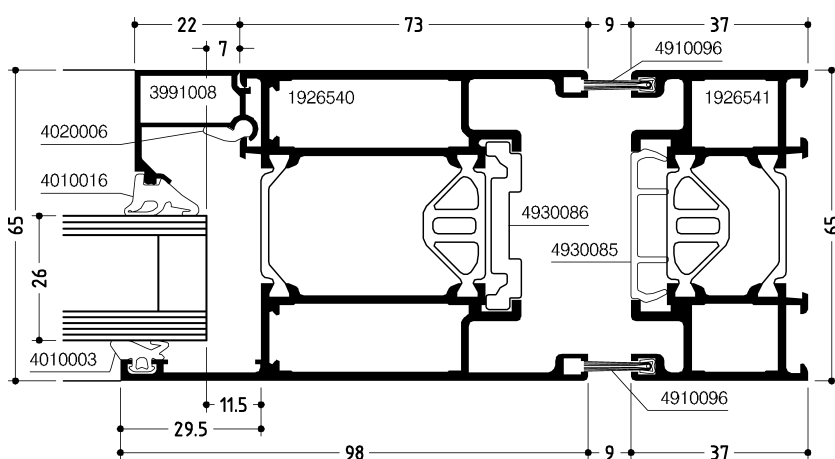

DOC-000845357

Pendeltüren
passend nur für
Bodentürschließer
*Double action
doors suitable only
for floor mounted
door closer*

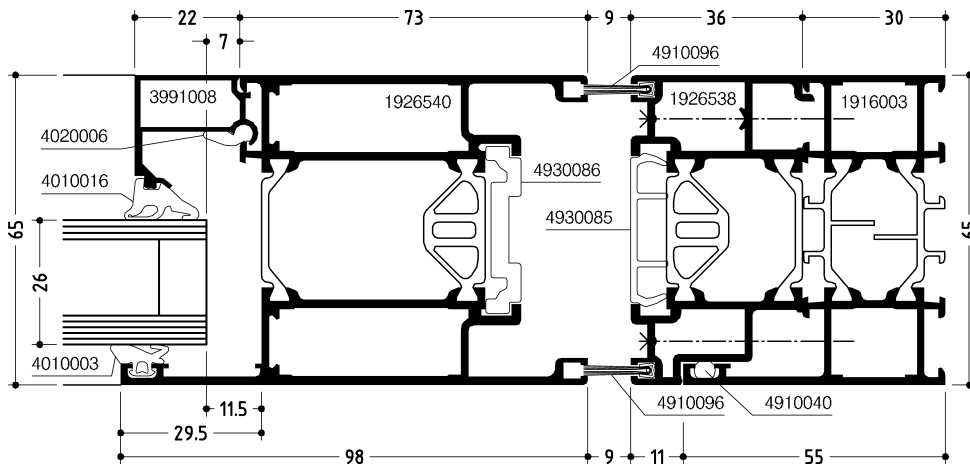

DOC-0000845083

Pendeltüren
passend für integ-
rierten Türschließer
*Double action
doors suitable for
integrated door
closer*

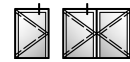
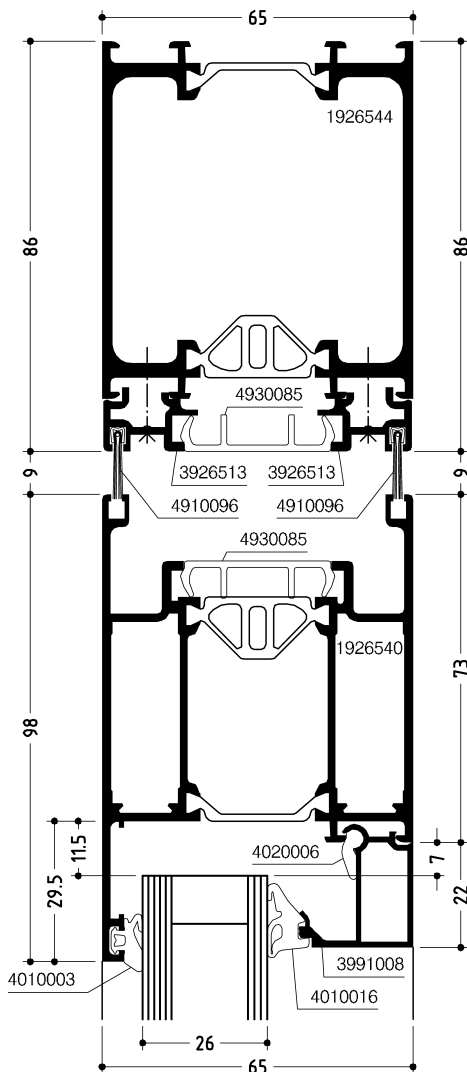

DOC-0000845642

Pendeltüren
passend für integ-
rierten Türschließer
*Double action
doors suitable for
integrated door
closer*

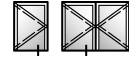
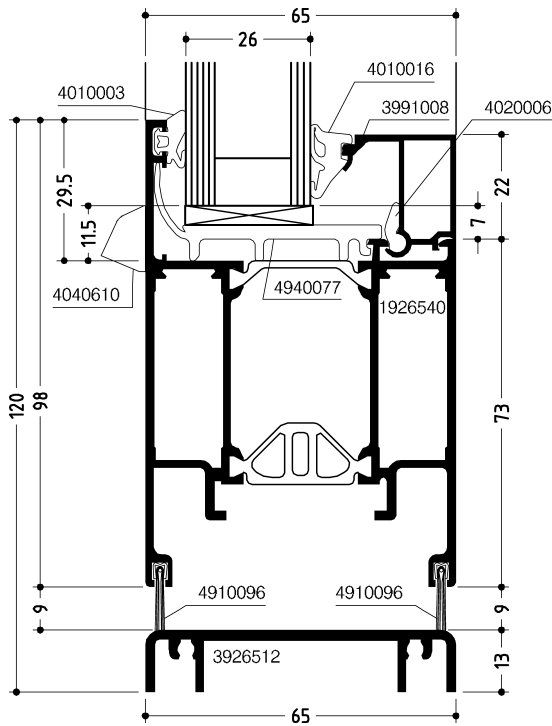

DOC-0000844418

Pendeltüren
passend für integ-
rierten Türschließer
*Double action
doors suitable for
integrated door
closer*

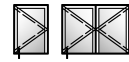
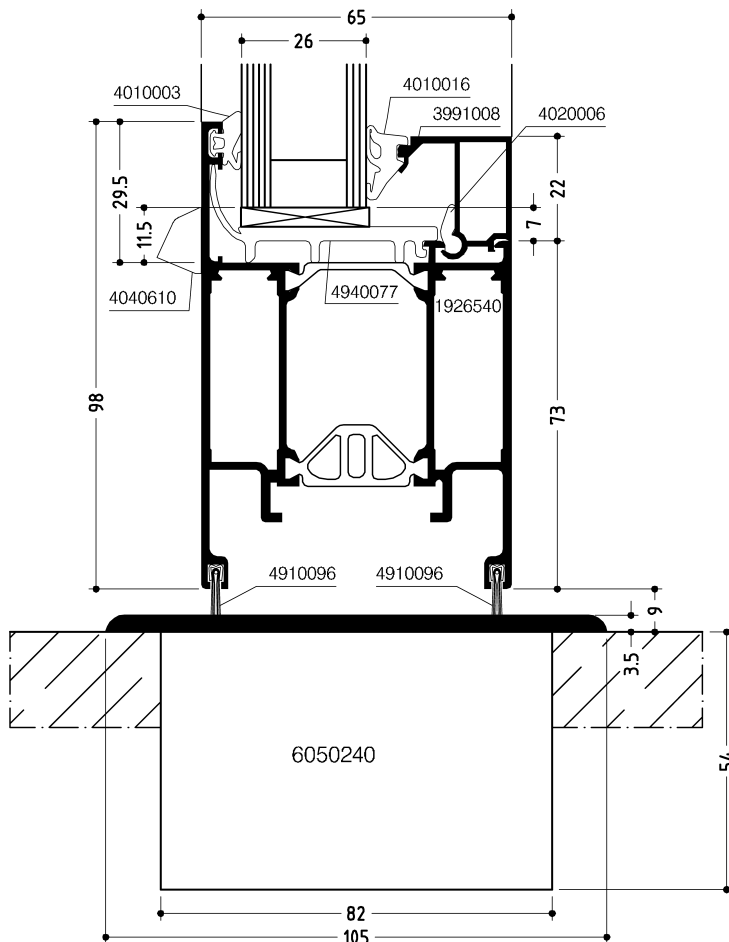

DOC-0000851863

Pendeltüren
passend nur für
Bodentürschließer
*Double action
doors suitable only
for floor door closer*

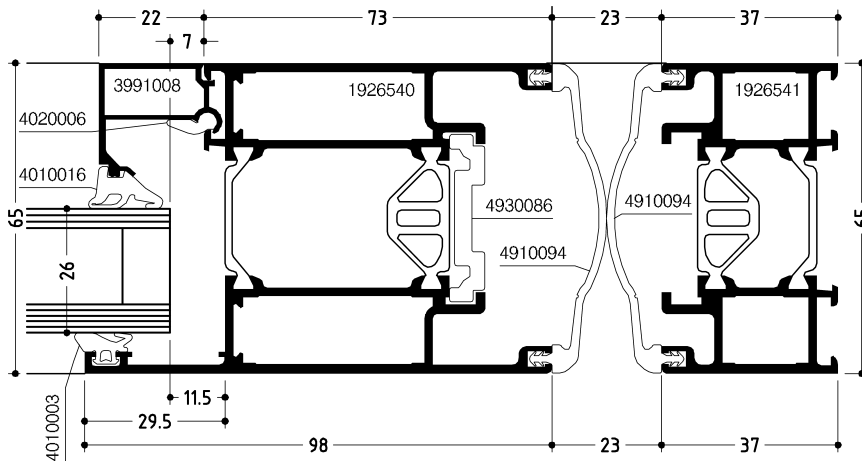

DOC-0000865526

Pendeltüren mit
Fingerschutz
passend nur für
Bodentürschließer

*Double action
doors with finger
protection suitable
only for floor door
closer*

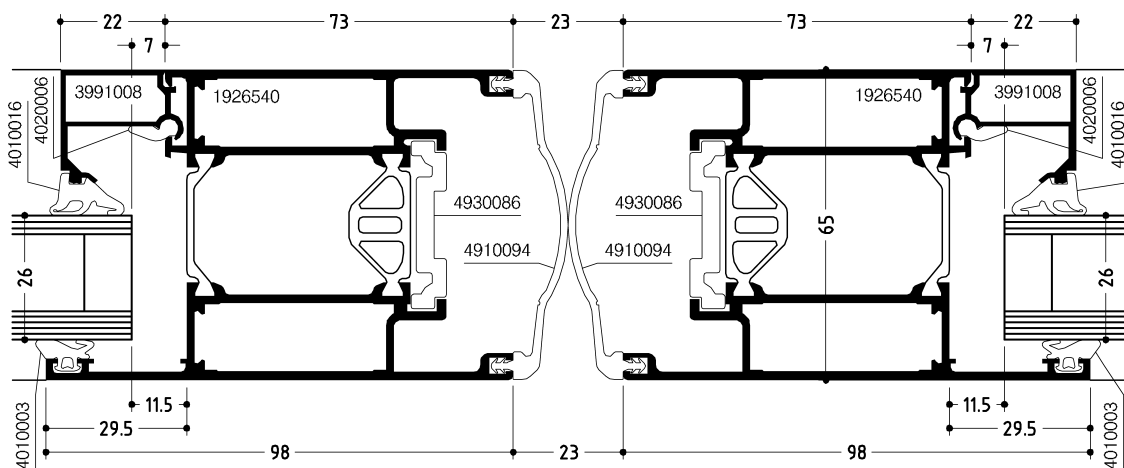

DOC-0000865499

Pendeltüren mit
Fingerschutz -
Mittelstoß

*Double action
doors with finger
protection -
meeting stiles*

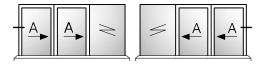
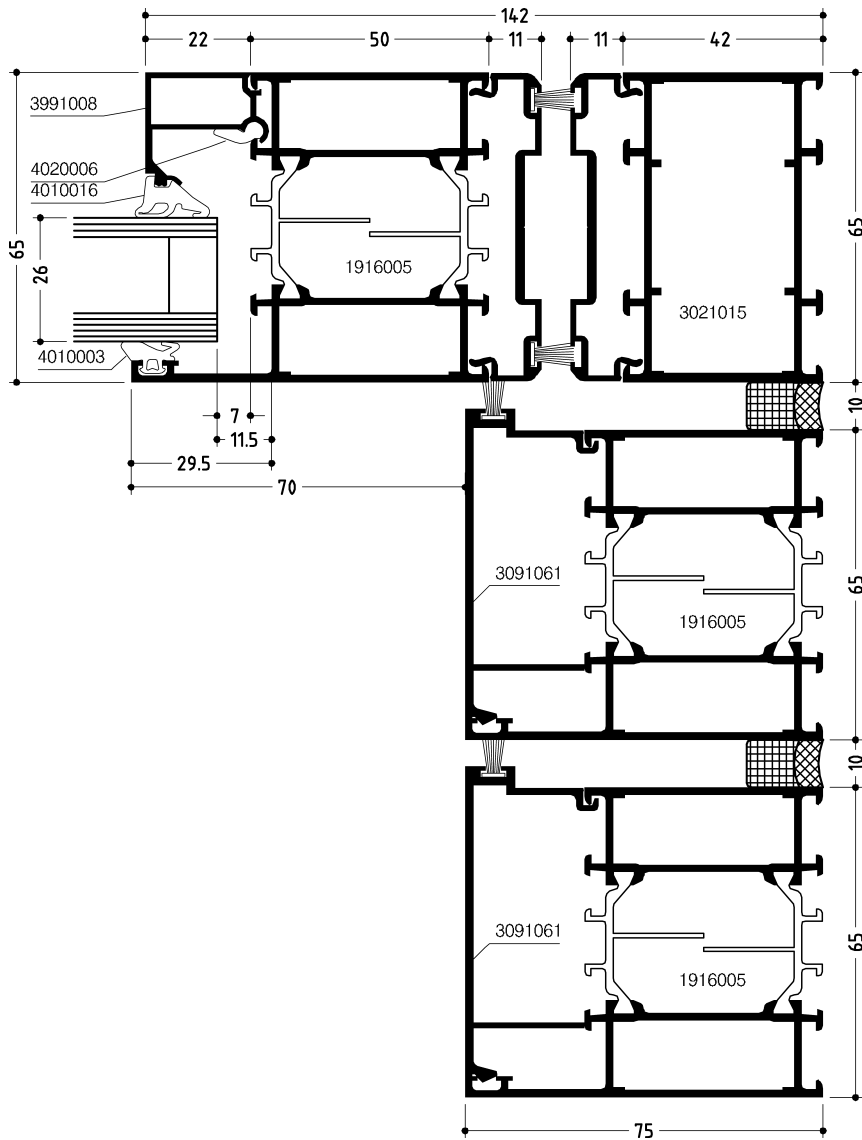

DOC-0001026599

Automatische
Schiebetüren
Schlosseite (G3)

Automatic sliding
doors Look side
(G3)

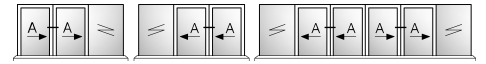
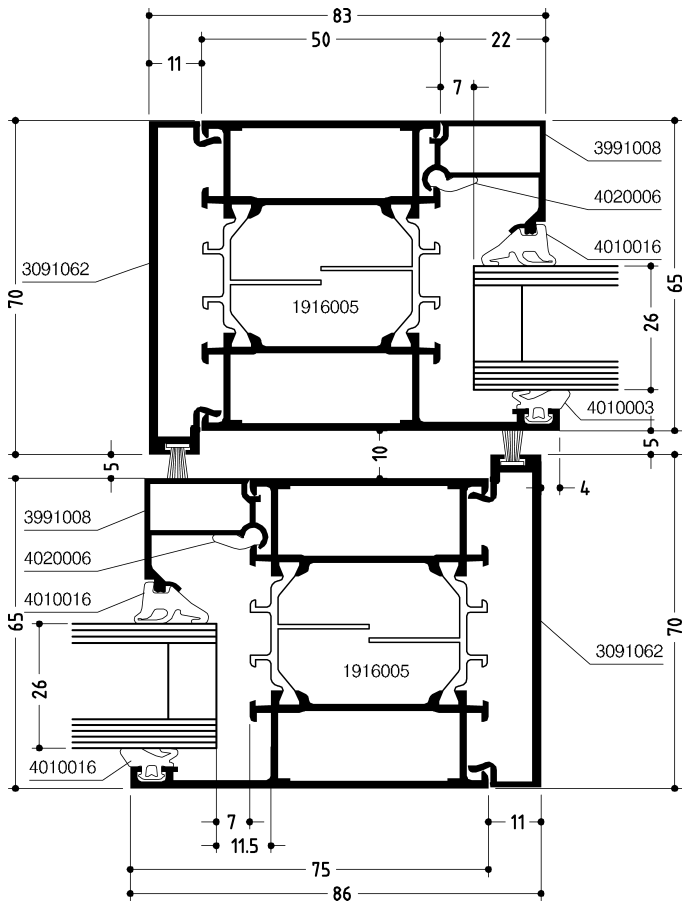

DOC-0001026792

Automatische
Schiebetüren
Verhakungszone
(G3, M)

*Automatic sliding
doors Hooking
zone (G3, M)*

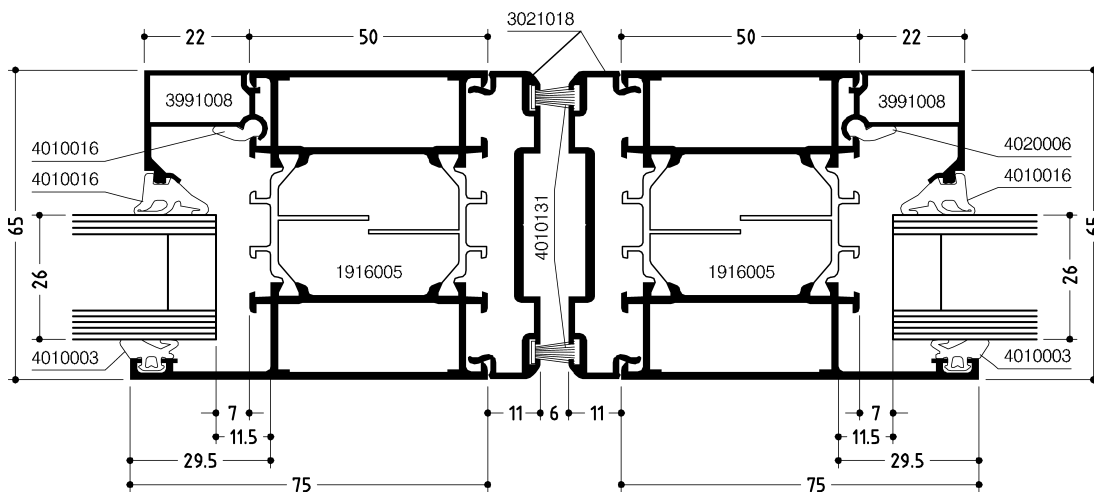

DOC-0001027059

Automatische
Schiebetüren, zwei-
flügelig Mittelstoß

*Automatic sliding
doors, double leaf
Meeting stiles*

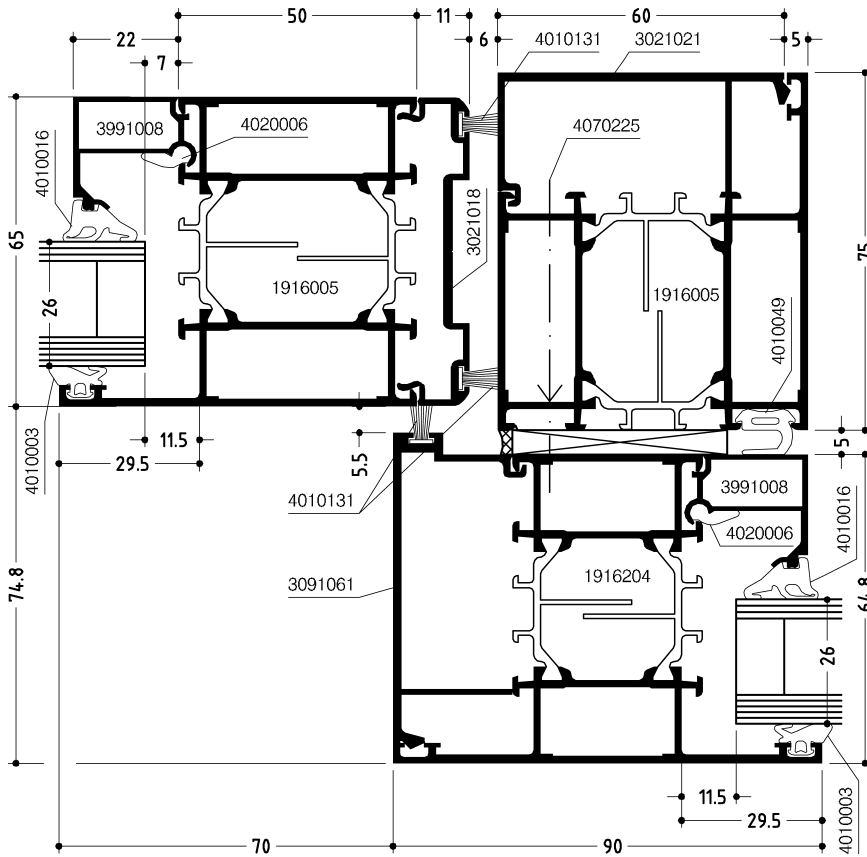

DOC-0001026973

Automatische
Schiebetüren
Verschluss-Seite,
alternativ (G)
*Automatic sliding
doors Lock side,
alterantive (G)*

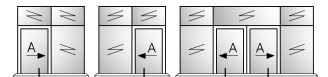
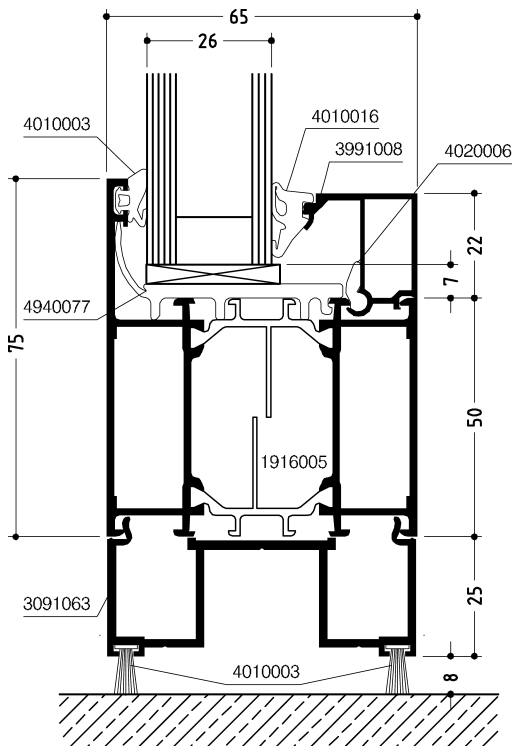

DOC-0001026927

Automatische
Schiebetüren
Bodenanschluss
*Automatic sliding
doors Bottom
junction*

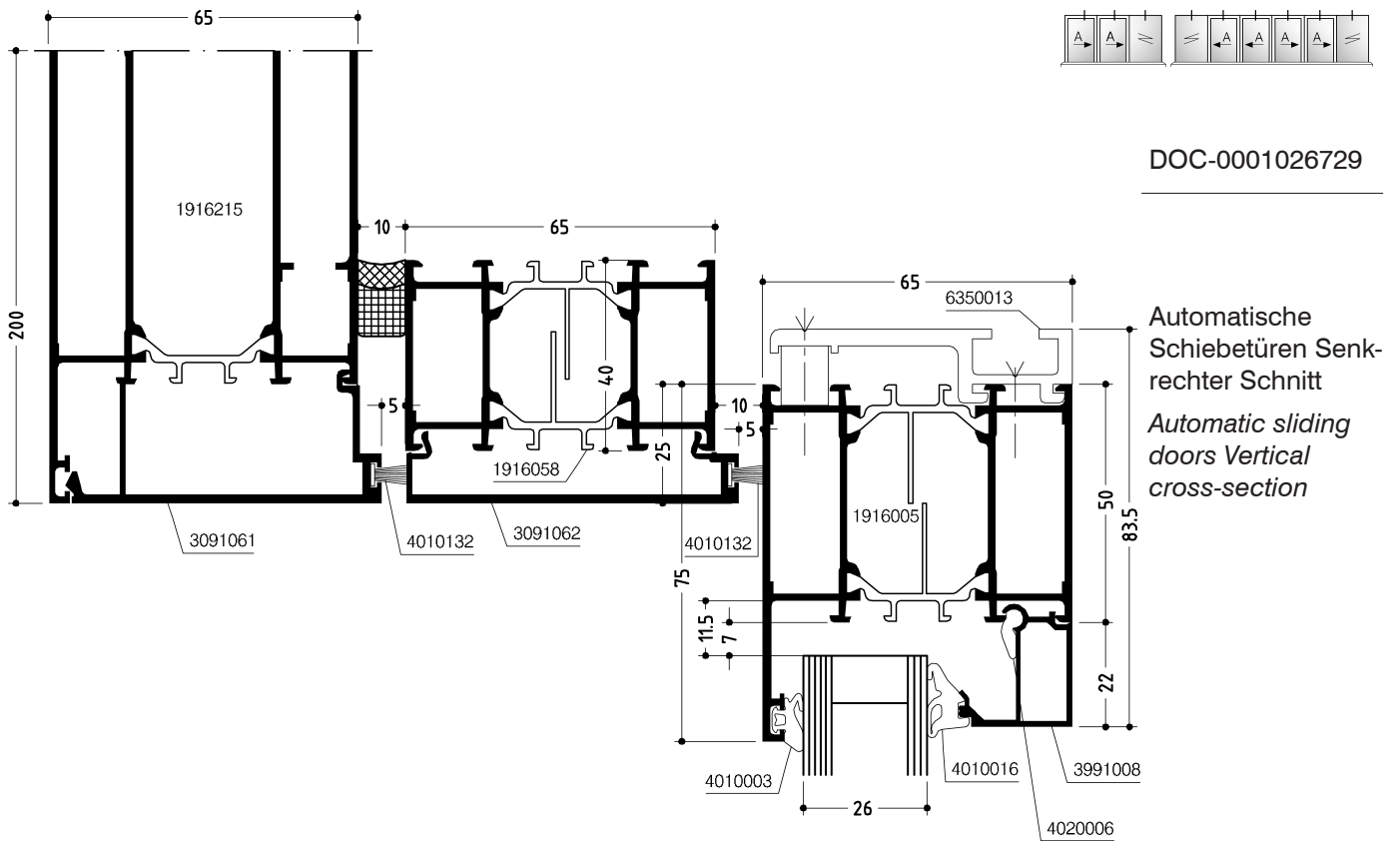

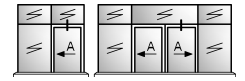
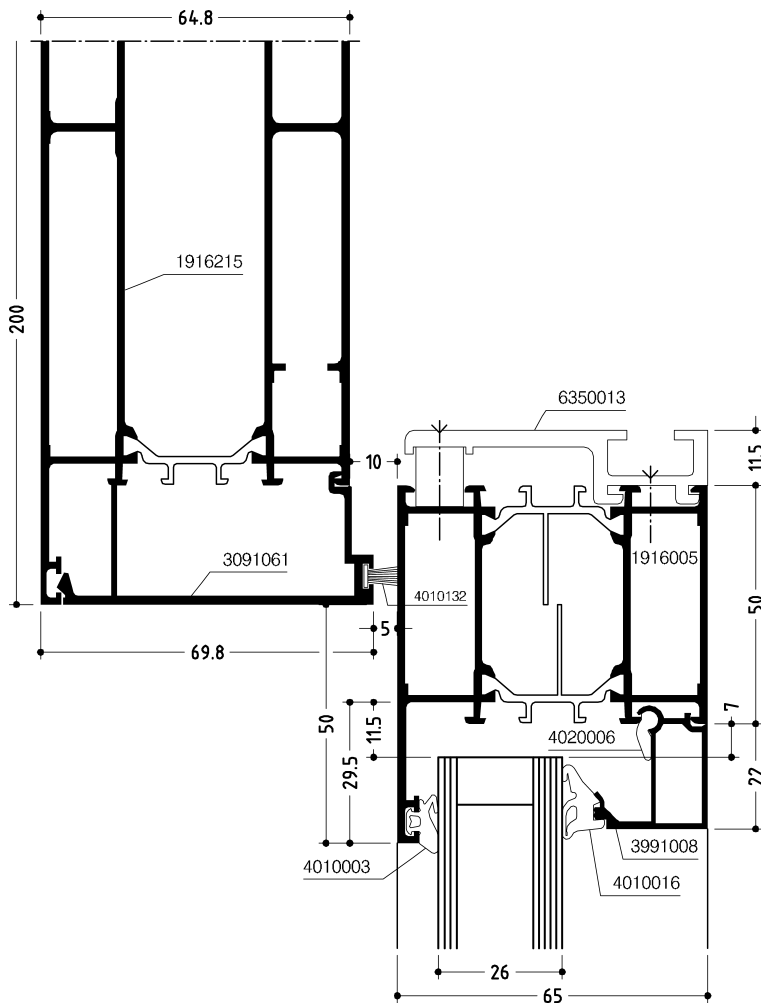

DOC-0001027107

Automatische
Schiebetüren
Senkrechter Schnitt
*Automatic sliding
doors
Vertical cross-
sections*

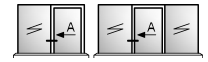
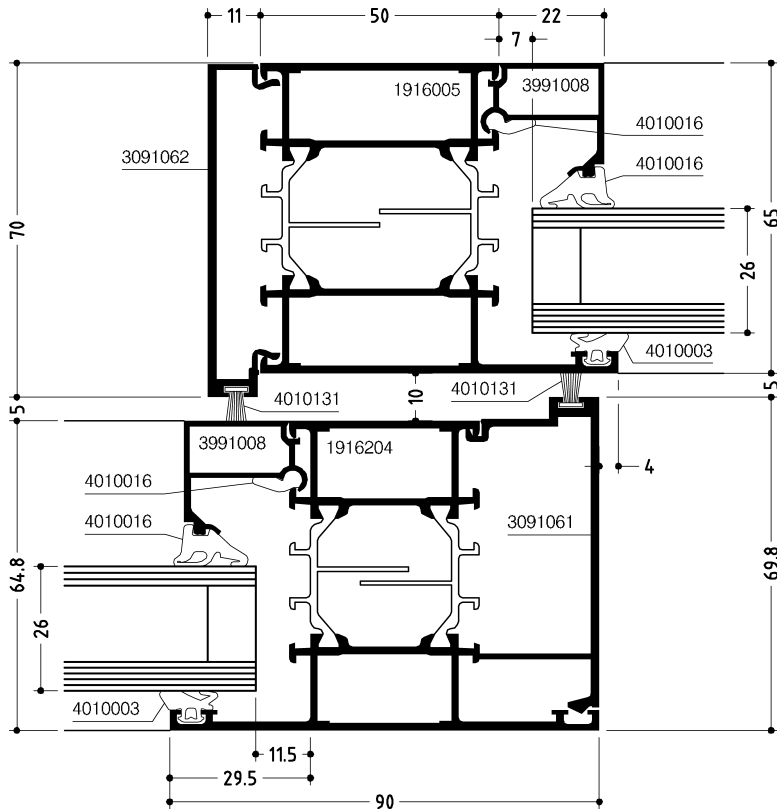

DOC-0001027038

Automatische
Schiebetüren
Mittelstoß

*Automatic sliding
doors
Meeting stiles*

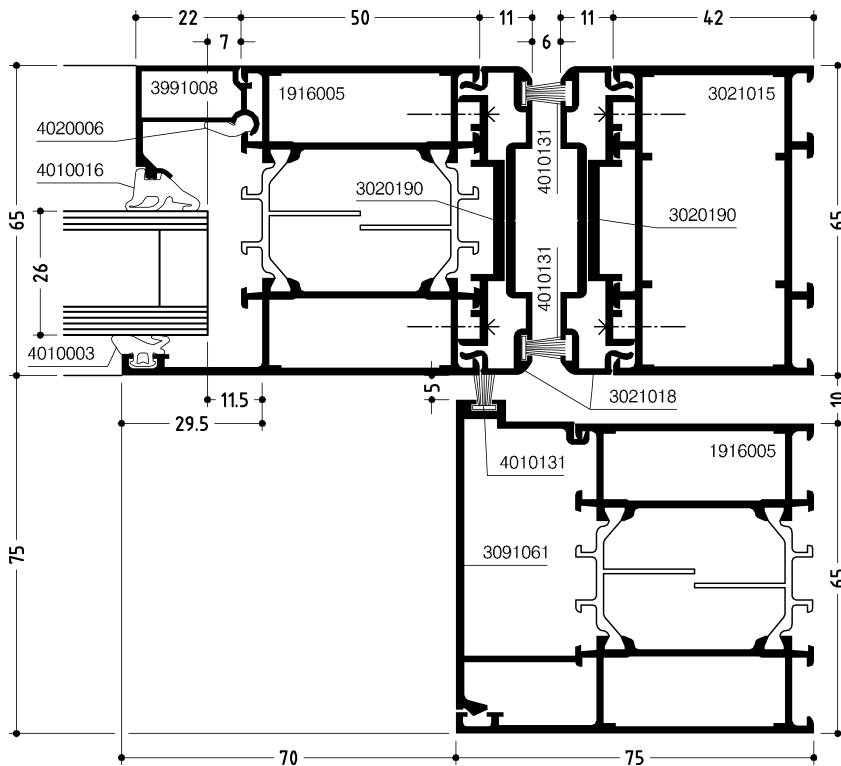

DOC-0001027079

Automatische
Schiebetüren
Verschluss-Seite
(A)

*Automatic sliding
doors
Lock side (A)*

Glasleistenprofile, Auswahltabellen Glazing bead profiles, selection tables

Die Auswahltabelle zeigt die verschiedenen Glasleistenprofile und die zulässigen Füllungsdicken mit Toleranzen.

Die Auswahltabelle ist für Trockenverglasung mittels EPDM-Dichtungsprofilen ausgelegt.

Bei der Verglasung sind die Vorschriften der Glashersteller und der einschlägigen Fachverbände zu beachten, insbesondere die Forderung nach einem funktionssicheren Dampfdruckausgleich und Entwässerung der Hohlräume im Glasfalzraum zwischen Isolierglas-Scheibenkante und Falzgrund.

Die Auswahltabellen ermöglichen eine theoretische Vorplanung. Die Glastoleranzen sind zu berücksichtigen. Um extreme Toleranzen der Profile und Füllungsdicken ausgleichen zu können, ist es vorteilhaft, bei der Planung die Füllungsdicken aus den punktschraffierten Feldern der Auswahltabelle zu entnehmen.

Bei der Montage sind die Vorgaben praktisch zu prüfen und gegebenenfalls durch Variationen der Einrolldichtungen, dargestellt durch die schraffierten Felder, die notwendige Vorspannung aufzubringen.

In der Tabelle sind die Artikelnummern der schwarzen Dichtungen angegeben. Weitere Farben (z. B. grau), siehe Programm / Zubehör.

The selection table shows the different glazing bead profiles and the admissible infill thicknesses with tolerances.

The selection table is designed for dry glazing with EPDM glazing gaskets.

Please follow the glazing instructions of glass manufacturers and relevant professional associations, especially the demand for a functionally secure air pressure equalization and drainage of cavities in glazing rebate area between insulation glass pane edge and rebate base.

The selection tables enable a preliminary theoretical planning. The glass tolerances have to be considered while planning. It is recommended to select infill thicknesses from the dotted columns areas of the selection table in order to compensate for extreme tolerances of profiles and infill thicknesses.

Check the specifications practically and, if required, apply the correct gasket pressure by choosing the suitable roll-in gaskets listed in the hatched columns.

The gasket article numbers specified in the table are for black gaskets. For further colours (e. g. grey), please consult our Product range / Accessories.

empfohlen
recommended

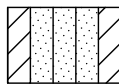

Beispiel / Example



	Dichtung schwarz Gasket black	Dichtung grau Gasket grey
Verglasungsdichtung außen Glazing gasket outside	4010003	4010243
Verglasungsdichtung innen Glazing gasket inside		
4 mm	4910004	4910082
5 mm	4010015	4010235
6 mm	4010016	4010236
7 mm	4010017	4010237
8 mm	4010018	4010238

Glasleistenprofile Glazing bead profil.		a) Füllungsdicke ± 1 mm mit Einrolldichtung Nr.: Infill thickness ± 1 mm with rolled gasket no.:				
Nr. / No.	b) mm	4910004	4010015 blau / blue	4010016 rot / red	4010017 grün / green	4010018
3991001	2	50	49	48	47	46
3991002	5	47	46	45	44	43
3090099	7	45	44	43	42	41
3991003	9	43	42	41	40	39
3991004	12	40	39	38	37	36
3991005	15	37	36	35	34	33
3090098	17	35	34	33	32	31
3991006	19	33	32	31	30	29
3991007	22	30	29	28	27	26
3991008	24	28	27	26	25	24
3991009	26	26	25	24	23	22
3991010	29	23	22	21	20	19
3991011	32	20	19	18	17	16
3991012	34	18	17	16	15	14
3991013	37	15	14	13	12	11
3991014	41	11	10	9	8	7

- ① Bautiefe auswählen
Select construction depth
- ② Füllungsdicke auswählen
Select infill thickness
- ③ Entsprechende Glasleiste
Appropriate glazing bead
- ④ Entsprechende innere Verglasungsdichtung
Appropriate inner glazing gasket

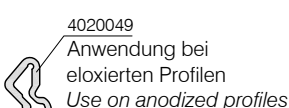
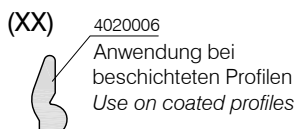
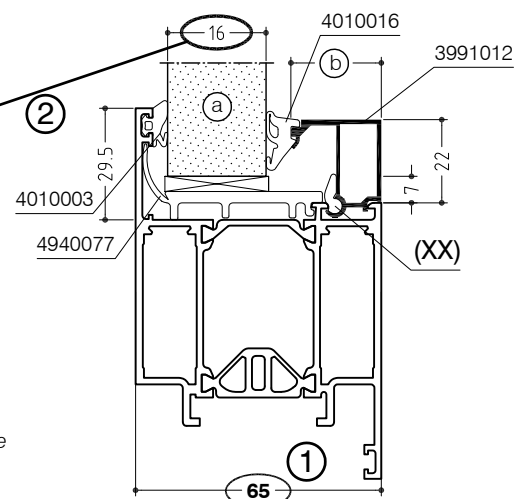

WICSTYLE 65 evo / 65

Technische Information Technical Information

Glasleistenprofile, Auswahltabellen
Glazing bead profiles, selection tables



Glasleistenprofile Glazing bead profiles			(a) Füllungsdicke ± 1 mm mit Einrolldichtung Nr.: Infill thickness ± 1 mm with rolled gasket no.:				
Nr. / No. 18 mm	Nr. / No. 22 mm	(b) mm	4910004	4010015 blau / blue	4010016 rot / red	4010017 grün / green	4010018
	3991001	2	50	49	48	47	46
3991022	3991002	5	47	46	45	44	43
3991023	3991003	9	43	42	41	40	39
3991024	3991004	12	40	39	38	37	36
3991025	3991005	15	37	36	35	34	33
3991026	3991006	19	33	32	31	30	29
3991027	3991007	22	30	29	28	27	26
3991028	3991008	24	28	27	26	25	24
3991029	3991009	26	26	25	24	23	22
3991030	3991010	29	23	22	21	20	19
3991031	3991011	32	20	19	18	17	16
3991032	3991012	34	18	17	16	15	14
3991033	3991013	37	15	14	13	12	11
3991034	3991014	41	11	10	9	8	7
3991035	3991015	45	7	6	5	4	3

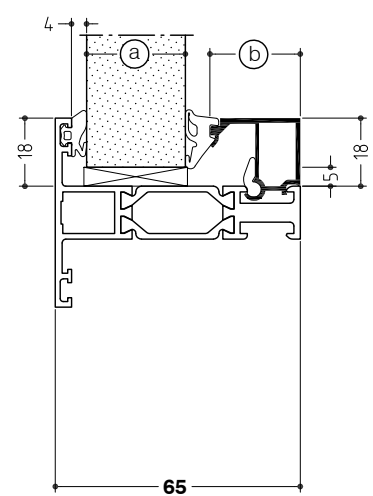
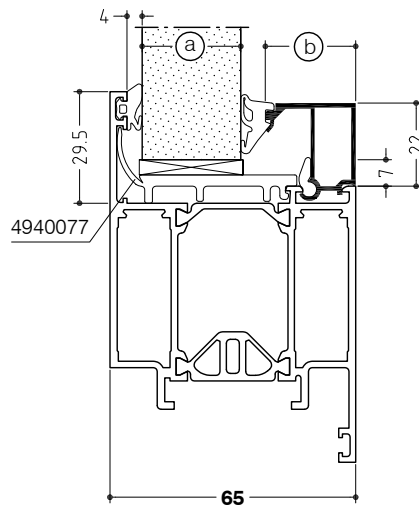
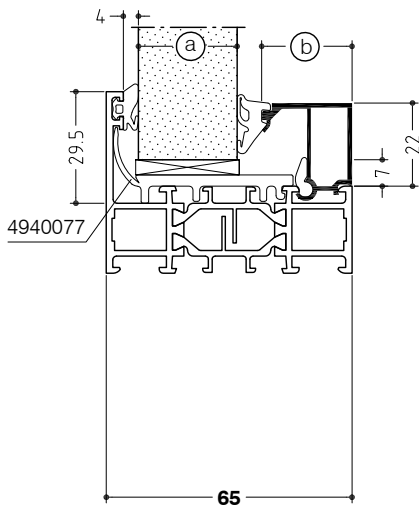

WICSTYLE 65 evo / 65

Glasleistenprofile, Auswahltabellen
Glazing bead profiles, selection tables



Glasleistenprofile Glazing bead profiles			(a) Füllungsdicke ±1 mm mit Einrolldichtung Nr.: Infill thickness ±1 mm with rolled gasket no.:				
Nr. / No. 18 mm	Nr. / No. 22 mm	(b) mm	4910004	4010015 blau / blue	4010016 rot / red	4010017 grün / green	4010018
	3991001	2	40	39	38	37	36
3991022	3991002	5	37	36	35	34	33
3991023	3991003	9	33	32	31	30	29
3991024	3991004	12	30	29	28	27	26
3991025	3991005	15	27	26	25	24	23
3991026	3991006	19	23	22	21	20	19
3991027	3991007	22	20	19	18	17	16
3991028	3991008	24	18	17	16	15	14
3991029	3991009	26	16	15	14	13	12
3991030	3991010	29	13	12	11	10	9
3991031	3991011	32	10	9	8	7	6
3991032	3991012	34	8	7	6	5	4
3991033	3991013	37	5	4	3	2	

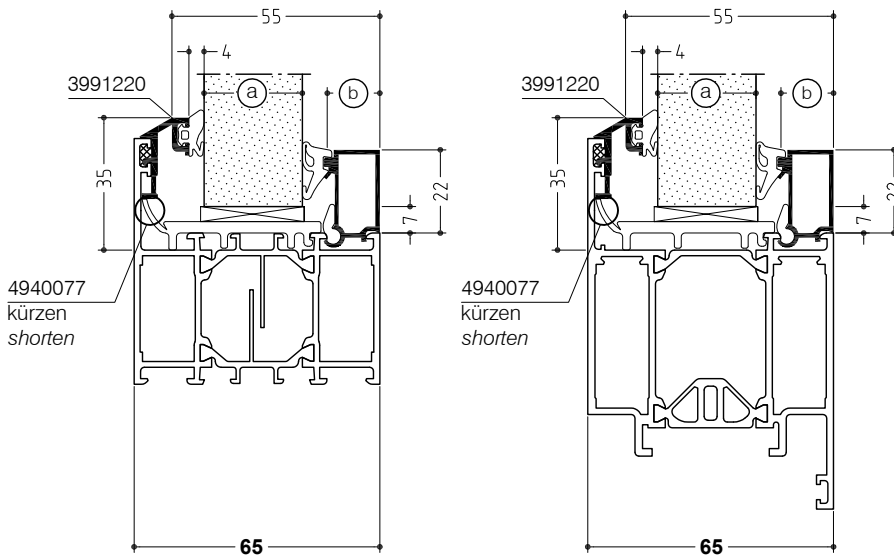



Türflügelprofile nach innen
Door leaf profiles inwards

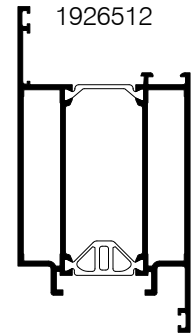
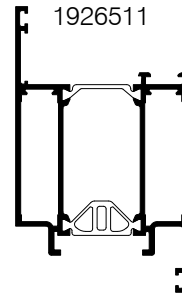
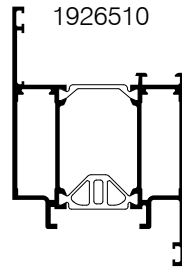

Türflügelprofile nach außen
Door leaf profiles outwards

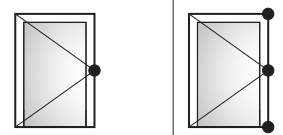
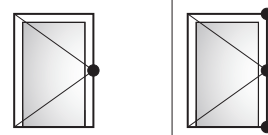
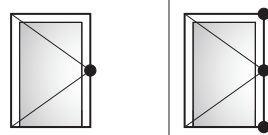
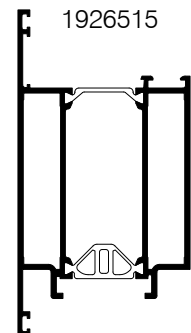
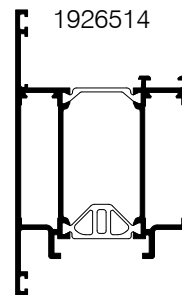
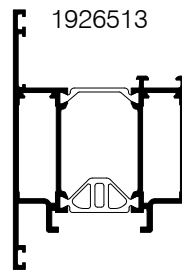

	(Pa)	800	400	800	800	400	800	800	400	800	
	(Pa)	150	150	150	150	150	150	150	150	150	
max.	FAB (m)	1.2	1.4	1.4	1.2	1.4	1.4	1.2	1.4	1.4	
	FAH (m)	2.3*	2.3*	2.52*	2.3*	2.3*	2.52*	2.3*	2.3*	2.52*	
min.	GF FAB (m)	0.6	0.6	0.6	0.6	0.6	0.6	0.6	0.6	0.6	
	SF FAB (m)	-	-	-	-	-	-	-	-	-	
	FAH (m)	-	-	-	-	-	-	-	-	-	
	min.	FAB (m)	0.6	0.6	0.6	0.6	0.6	0.6	0.6	0.6	
FAH (m)		2.01**	2.01**	2.01**	2.01**	2.01**	2.01**	2.01**	2.01**	2.01**	
	min.	FAB (m)	0.6	0.6	-	0.6	0.6	-	0.6	0.6	-
FAH (m)		2.01	2.01	-	2.01	2.01	-	2.01	2.01	-	
	max.(kg)	200			200			200			

* FAH > 2.2 m zusätzliches Mittelband erforderlich, RC1 N FAH_{max.} 2.1 m bei Einfallenverriegelung
* FAH > 2.2 m additional centre hinge required, RC1 N FAH_{max.} 2.1 m with single latch lockings

** RC1 N ohne Beschränkung FAH
** RC1 N without restriction FAH

WICSTYLE 65 evo

Fingerschutztüren
Finger protection doors

Zulässige Flügelgrößen
Admissible leaf sizes



Türflügelprofile nach innen
Door leaf profiles inwards

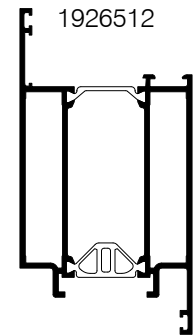
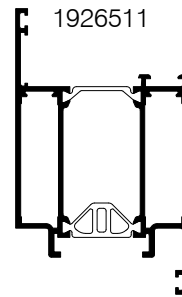
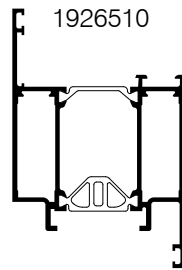

Türflügelprofile nach außen
Door leaf profiles outwards

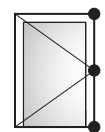
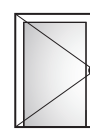
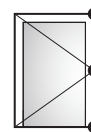
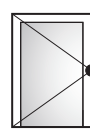
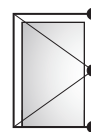
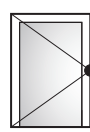
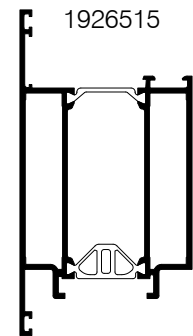
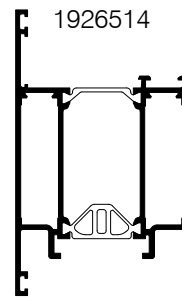
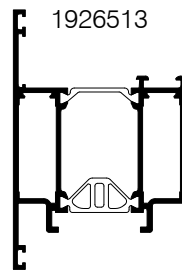

	(Pa)	800	400	800	800	400	800	800	400	800
	(Pa)	150	150	150	150	150	150	150	150	150
max.	FAB (m)	1.2	1.4	1.4	1.2	1.4	1.4	1.2	1.4	1.4
	FAH (m)	2.3*	2.3*	2.52*	2.3*	2.3*	2.52*	2.3*	2.3*	2.52*
min.	GF FAB (m)	0.6	0.6	0.6	0.6	0.6	0.6	0.6	0.6	0.6
	SF FAB (m)	-	-	-	-	-	-	-	-	-
	FAH (m)	-	-	-	-	-	-	-	-	-
	min. FAB (m)	-	-	-	-	-	-	-	-	-
	FAH (m)	-	-	-	-	-	-	-	-	-
	min. FAB (m)	-	-	-	-	-	-	-	-	-
	FAH (m)	-	-	-	-	-	-	-	-	-
	max. (kg)	200			200			200		

* FAH > 2.2 m zusätzliches Mittelband erforderlich

* FAH > 2.2 m additional centre hinge required

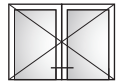

		1926513		1926514			1926515		
		1926510		1926511			1926512		
	(Pa)	400	800	400	400	800	400	400	800
	(Pa)	100	150	100	150	150	100	150	150
max.	FAB (m)	1.2	1.2	1.2	1.4	1.2	1.2	1.4	1.2
	FAH (m)	2.3*	2.52*	2.3*	2.52*	2.52*	2.3*	2.52*	2.52*
min.	GF FAB (m)	0.6	0.6	0.6	0.6	0.6	0.6	0.6	0.6
	SF FAB (m)	0.6	0.6	0.6	0.6	0.6	0.6	0.6	0.6
	FAH (m)	-	-	-	-	-	-	-	-
	min.	FAB (m)	0.6	0.6	0.6	0.6	0.6	0.6	0.6
	FAH (m)	2.01	2.01 **	2.01	2.01**	2.01**	2.01	2.01**	2.01**
	min.	FAB (m)	0.6	-	0.6	-	-	0.6	-
	FAH (m)	2.01	-	2.01	-	-	2.01	-	-
	max. (kg)	200		200			200		

* FAH > 2.2 m zusätzliches Mittelband erforderlich, RC1 N FAH_{max.} 2.1 m bei Einfallenverriegelung
 * FAH > 2.2 m additional centre hinge required, RC1 N FAH_{max.} 2.1 m with single latch lockings

** RC1 N ohne Beschränkung FAH
 ** RC1 N without restriction FAH

WICSTYLE 65 evo

Fingerschutztüren
Finger protection doors

Zulässige Flügelgrößen
Admissible leaf sizes



		1926513		1926514		1926515	
		1926510		1926511		1926512	
	(Pa)	400	800	400	800	400	800
	(Pa)	100	150	100	150	100	150
max.	FAB (m)	1.2	1.2	1.2	1.2	1.2	1.2
	FAH (m)	2.3*	2.52*	2.3*	2.52*	2.3*	2.52*
min.	GF FAB (m)	0.6	0.6	0.6	0.6	0.6	0.6
	SF FAB (m)	0.6	0.6	0.6	0.6	0.6	0.6
	FAH (m)	-	-	-	-	-	-
	min. FAB (m)	-	-	-	-	-	-
	FAH (m)	-	-	-	-	-	-
	min. FAB (m)	-	-	-	-	-	-
	FAH (m)	-	-	-	-	-	-
	max.(kg)	200		200		200	

* FAH > 2.2 m zusätzliches Mittelband erforderlich

* FAH > 2.2 m additional centre hinge required

WICSTYLE 65 evo

Gegentakttüren
Push-pull doors

Zulässige Flügelgrößen
Admissible leaf sizes

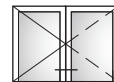

		1926513		1926514		1926515	
		1926510		1926511		1926512	
	(Pa)	400	-	400	-	400	-
	(Pa)	-	-	-	-	-	-
max.	FAB (m)	1.2	-	1.2	-	1.2	-
	FAH(m)	2.3*	-	2.3*	-	2.3*	-
min.	GF FAB (m)	0.6	-	0.6	-	0.6	-
	SF FAB (m)	0.6	-	0.6	-	0.6	-
	FAH (m)	-	-	-	-	-	-
	min.	FAB (m)	-	-	-	-	-
		FAH (m)	-	-	-	-	-
	min.	FAB (m)	-	-	-	-	-
		FAH (m)	-	-	-	-	-
	max.(kg)	200		200		200	

* FAH > 2.2 m zusätzliches Mittelband erforderlich

* FAH > 2.2 m additional centre hinge required

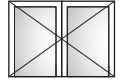

Türflügelprofile nach innen
Door leaf profiles inwards

Türflügelprofile nach außen
Door leaf profiles outwards

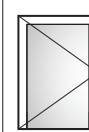
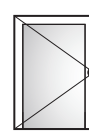
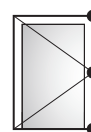
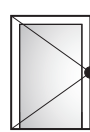
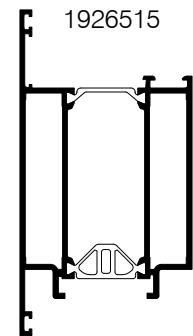
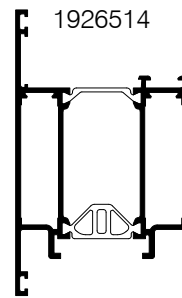
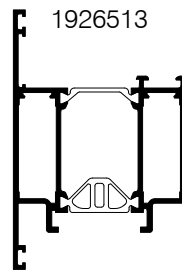
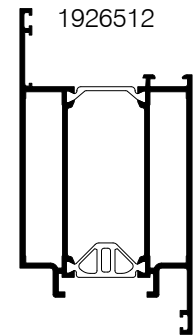
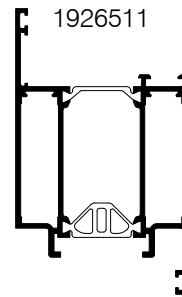
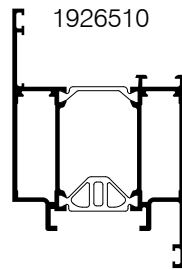
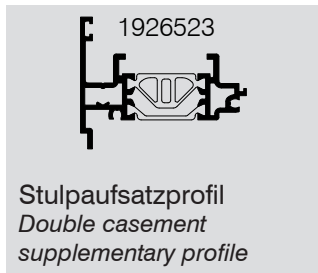

(Pa)		400	800	400	400	800	400	400	800
(Pa)		100	150	100	150	150	100	150	150
max.	FAB (m)	1.2	1.2	1.2	1.4	1.2	1.2	1.4	1.2
	FAH (m)	2.3*	2.52*	2.3*	2.52*	2.52*	2.3*	2.52*	2.52*
min.	GF FAB (m)	0.6	0.6	0.6	0.6	0.6	0.6	0.6	0.6
	SF FAB (m)	0.6	0.6	0.6	0.6	0.6	0.6	0.6	0.6
	FAH (m)	-	-	-	-	-	-	-	-
min.	FAB (m)	0.6	0.6	0.6	0.6	0.6	0.6	0.6	0.6
	FAH (m)	2.01	2.01**	2.01	2.01**	2.01**	2.01	2.01**	2.01**
min.	FAB (m)	0.6	-	0.6	-	-	0.6	-	-
	FAH (m)	2.01	-	2.01	-	-	2.01	-	-
max. (kg)		200		200			200		

* FAH > 2.2 m zusätzliches Mittelband erforderlich

* FAH > 2.2 m additional centre hinge required

** RC1 N ohne Beschränkung FAH

** RC1 N without restriction FAH

WICSTYLE 65 evo

Fingerschutztüren
Finger protection doors

Zulässige Flügelgrößen
Admissible leaf sizes



Türflügelprofile nach innen
Door leaf profiles inwards

Türflügelprofile nach außen
Door leaf profiles outwards

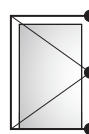
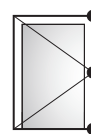
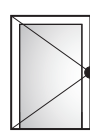
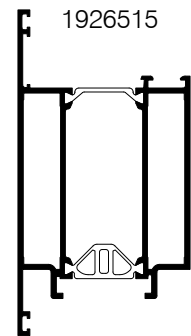
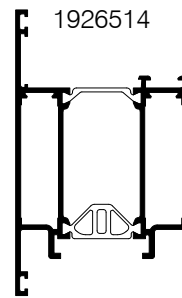
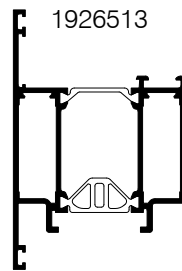
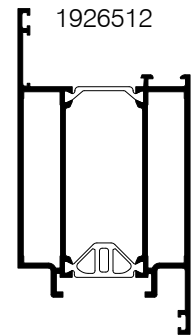
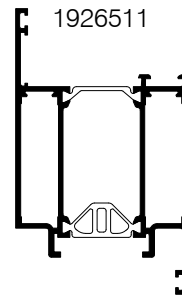
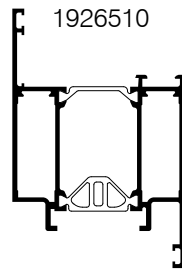
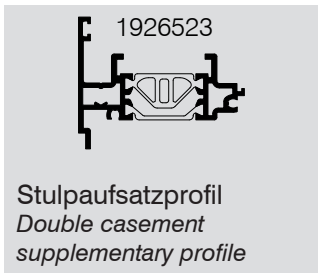

	(Pa)	400	800	400	800	400	800
	(Pa)	100	150	100	150	100	150
max.	FAB (m)	1.2	1.2	1.2	1.2	1.2	1.2
	FAH (m)	2.3*	2.52*	2.3*	2.52*	2.3*	2.52*
min.	GF FAB (m)	0.6	0.6	0.6	0.6	0.6	0.6
	SF FAB (m)	0.6	0.6	0.6	0.6	0.6	0.6
	FAH (m)	-	-	-	-	-	-
	min. FAB (m)	-	-	-	-	-	-
	FAH (m)	-	-	-	-	-	-
	min. FAB (m)	-	-	-	-	-	-
	FAH (m)	-	-	-	-	-	-
	max. (kg)	200		200		200	

* FAH > 2.2 m zusätzliches Mittelband erforderlich

* FAH > 2.2 m additional centre hinge required

WICSTYLE 65 evo

Fluchttürverschlusssysteme
Escape door lock systems

Zulässige Flügelgrößen
Admissible leaf sizes



Türflügelprofile nach innen
Door leaf profiles inwards

Türflügelprofile nach außen
Door leaf profiles outwards

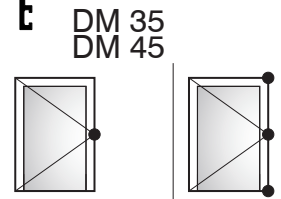
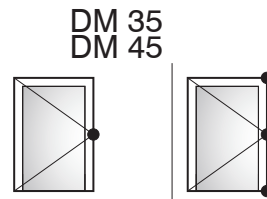
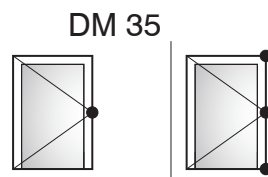
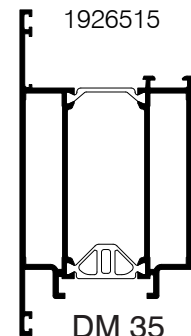
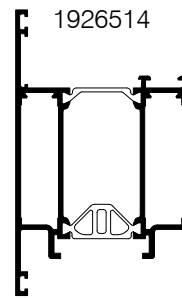
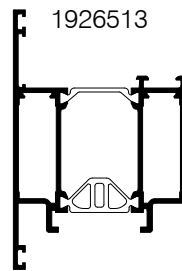
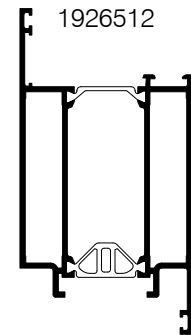
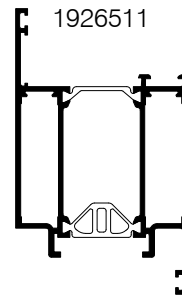
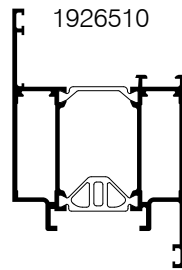

	(Pa)	800	400	800	800	400	800	800	400	800	
	(Pa)	150	150	150	150	150	150	150	150	150	
max.	FAB (m)	1.2	1.4	1.4	1.2	1.4	1.4	1.2	1.4	1.4	
	FAH (m)	2.3*	2.3*	2.52*	2.3*	2.3*	2.52*	2.3*	2.3*	2.52*	
min.	GF FAB (m)	0.9	0.9	0.9	0.9	0.9	0.9	0.9	0.9	0.9	
	SF FAB (m)	-	-	-	-	-	-	-	-	-	
	FAH (m)	-	-	-	-	-	-	-	-	-	
	min.	FAB (m)	0.9**	0.9**	0.9	0.9**	0.9**	0.9	0.9**	0.9**	0.9
		FAH (m)	2.01**	2.01**	2.01**	2.01**	2.01**	2.01**	2.01**	2.01**	2.01**
	min.	FAB (m)	-	-	-	-	-	-	-	-	-
		FAH (m)	-	-	-	-	-	-	-	-	-
	max. (kg)	200			200			200			

* FAH > 2.2 m zusätzliches Mittelband erforderlich, RC1 N FAH_{max.} 2.1 m bei Einfallenverriegelung
* FAH > 2.2 m additional centre hinge required, RC1 N FAH_{max.} 2.1 m with single latch lockings

** RC1 N ohne Beschränkung FAH
** RC1 N without restriction FAH

WICSTYLE 65 evo

Fluchttürverschlusssysteme
Escape door lock systems

Zulässige Flügelgrößen
Admissible leaf sizes



Türflügelprofile nach innen
Door leaf profiles inwards

Türflügelprofile nach außen
Door leaf profiles outwards

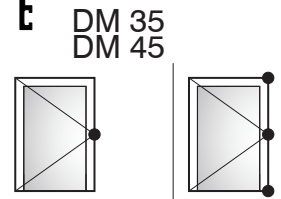
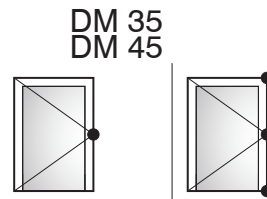
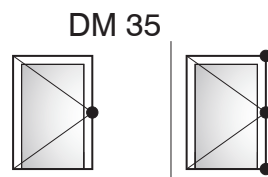
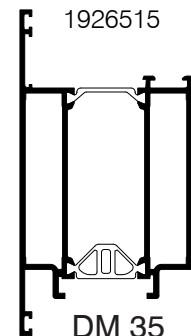
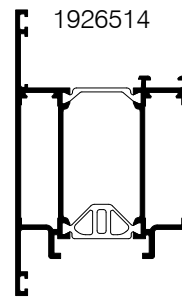
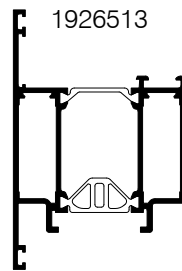
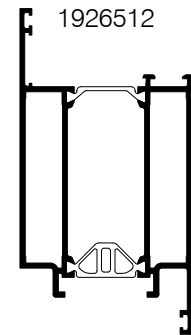
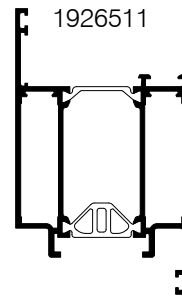
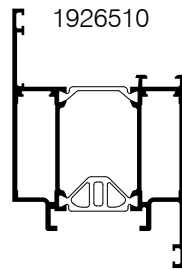

	(Pa)	800	400	800	800	400	800	800	400	800	
	(Pa)	150	150	150	150	150	150	150	150	150	
max.	FAB (m)	1.2	1.4	1.4	1.2	1.4	1.4	1.2	1.4	1.4	
	FAH (m)	2.3*	2.3*	2.52*	2.3*	2.3*	2.52*	2.3*	2.3*	2.52*	
min.	GF FAB (m)	0.9	0.9	0.9	0.9	0.9	0.9	0.9	0.9	0.9	
	SF FAB (m)	-	-	-	-	-	-	-	-	-	
	FAH (m)	-	-	-	-	-	-	-	-	-	
	min.	FAB (m)	0.9**	0.9**	0.9	0.9**	0.9**	0.9	0.9**	0.9**	0.9
		FAH (m)	2.01**	2.01**	2.01**	2.01**	2.01**	2.01**	2.01**	2.01**	2.01**
	min.	FAB (m)	0.9	0.9	-	0.9	0.9	-	0.9	0.9	-
		FAH (m)	2.01	2.01	-	2.01	2.01	-	2.01	2.01	-
	max. (kg)	200			200			200			

* FAH > 2.2 m zusätzliches Mittelband erforderlich, RC1 N FAH_{max.} 2.1 m bei Einfallenverriegelung
* FAH > 2.2 m additional centre hinge required, RC1 N FAH_{max.} 2.1 m with single latch lockings

** RC1 N ohne Beschränkung FAH
** RC1 N without restriction FAH

WICSTYLE 65 evo

Fluchttürverschlusssysteme
Escape door lock systems

Zulässige Flügelgrößen
Admissible leaf sizes

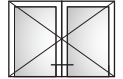

		1926513		1926514			1926515			
		1926510		1926511			1926512			
		DM 35/35		DM 35/35 DM 45/45			DM 35/35 DM 45/45			
	(Pa)	400	800	400	400	800	400	400	800	
	(Pa)	100	150	100	150	150	100	150	150	
max.	FAB (m)	1.2	1.2	1.2	1.4	1.2	1.2	1.4	1.2	
	FAH(m)	2.3*	2.52*	2.3*	2.52*	2.52*	2.3*	2.52*	2.52*	
min.	GF FAB (m)	0.9	0.9	0.9	0.9	0.9	0.9	0.9	0.9	
	SF FAB (m)	0.68	0.68	0.68	0.68	0.68	0.68	0.68	0.68	
	FAH (m)	-	2.0	-	2.0	2.0	-	2.0	2.0	
	min.	GF FAB (m)	-	0.9	-	0.9	0.9	-	0.9	0.9
		FAH (m)	-	-	-	-	-	-	-	-
	min.	GF FAB (m)	-	-	-	-	-	-	-	-
		FAH (m)	-	-	-	-	-	-	-	-
	max.(kg)	200		200			200			

* FAH > 2.2 m zusätzliches Mittelband erforderlich

* FAH > 2.2 m additional centre hinge required

WICSTYLE 65 evo

Fluchttürverschlusssysteme
Escape door lock systems

Zulässige Flügelgrößen
Admissible leaf sizes

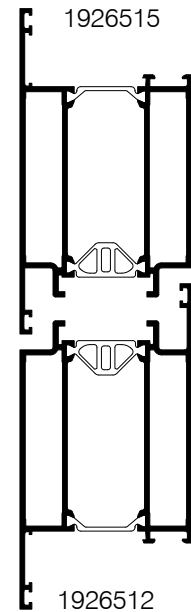
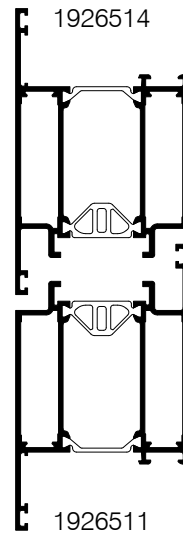
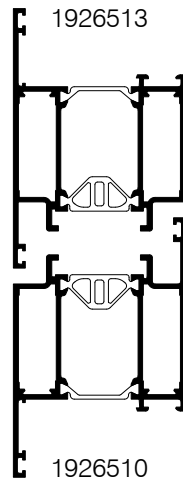

DM 35/35

DM 45/45

DM 45/45

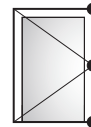

	(Pa)	400	800	400	400	800	400	400	800
	(Pa)	100	150	100	150	150	100	150	150
max.	FAB (m)	1.2	1.2	1.2	1.4	1.2	1.2	1.4	1.2
	FAH (m)	2.3*	2.52*	2.3*	2.52*	2.52*	2.3*	2.52*	2.52*
min.	GF FAB (m)	0.9	0.9	0.9	0.9	0.9	0.9	0.9	0.9
	SF FAB (m)	0.68	0.68	0.68	0.68	0.68	0.68	0.68	0.68
	FAH (m)	-	2.0	-	2.0	2.0	-	2.0	2.0
	min.	GF FAB (m)	0.9**	0.9**	0.9**	0.9**	0.9**	0.9**	0.9**
		FAH (m)	2.01**	2.01**	2.01**	2.01**	2.01**	2.01**	2.01**
	min.	GF FAB (m)	0.9***	-	0.9***	-	-	0.9***	-
		FAH (m)	2.01***	-	2.01***	-	-	2.01***	-
	max. (kg)	200		200			200		

* FAH > 2.2 m zusätzliches Mittelband erforderlich

* FAH > 2.2 m additional centre hinge required

** RC1 N ohne Beschränkung FAH

** RC1 N without restriction FAH

*** RC3 nur Teilpanik

*** RC3 partial panic



DM 35/35
Ausführung nur mit Druckstange möglich
Only version with touch-bar possible

WICSTYLE 65 evo

Fluchttürverschlusssysteme
Escape door lock systems

Zulässige Flügelgrößen
Admissible leaf sizes

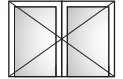

Türflügelprofile nach innen
Door leaf profiles inwards

Türflügelprofile nach außen
Door leaf profiles outwards

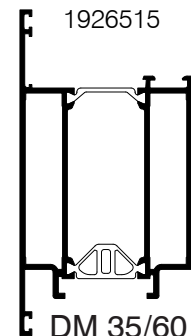
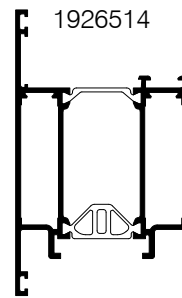
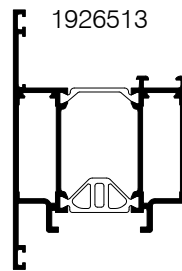
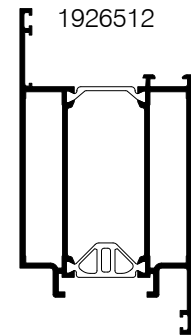
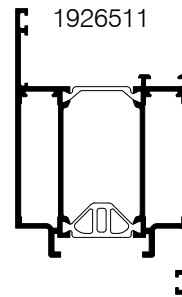
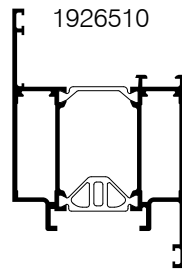
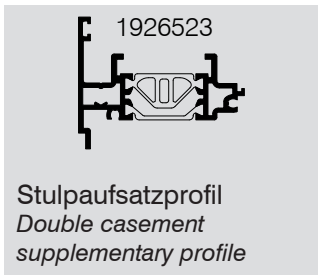

DM 35/60

DM 35/60
DM 45/70

DM 35/60
DM 45/70

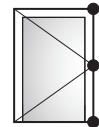
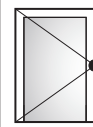
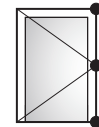
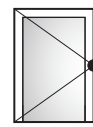
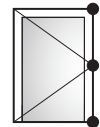
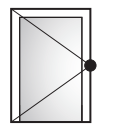

	(Pa)	400	800	400	400	800	400	400	800
	(Pa)	100	150	100	150	150	100	150	150
max.	FAB (m)	1.2	1.2	1.2	1.4	1.2	1.2	1.4	1.2
	FAH (m)	2.3*	2.52*	2.3*	2.52*	2.52*	2.3*	2.52*	2.52*
min.	GF FAB (m)	0.9	0.9	0.9	0.9	0.9	0.9	0.9	0.9
	SF FAB (m)	0.68	0.68	0.68	0.68	0.68	0.68	0.68	0.68
	FAH (m)	-	2.0	-	2.0	2.0	-	2.0	2.0
min.	GF FAB (m)	-	0.9	-	0.9	0.9	-	0.9	0.9
	FAH (m)	-	-	-	-	-	-	-	-
RC3 min.	GF FAB (m)	-	-	-	-	-	-	-	-
	FAH (m)	-	-	-	-	-	-	-	-
max.	max.(kg)	200		200			200		

* FAH > 2.2 m zusätzliches Mittelband erforderlich

* FAH > 2.2 m additional centre hinge required

WICSTYLE 65 evo

Fluchttürverschlusssysteme
Escape door lock systems

Zulässige Flügelgrößen
Admissible leaf sizes

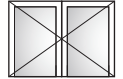

Türflügelprofile nach innen
Door leaf profiles inwards

Türflügelprofile nach außen
Door leaf profiles outwards

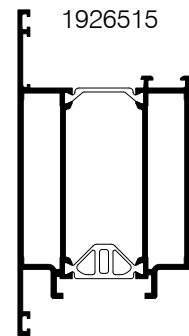
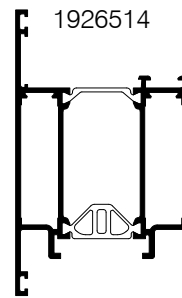
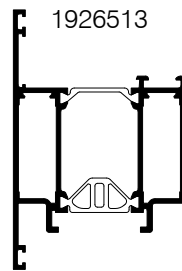
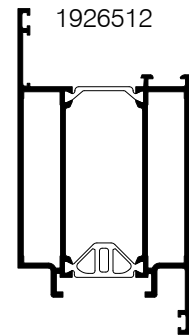
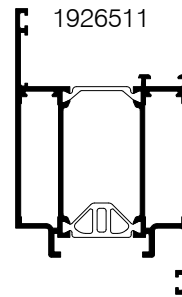
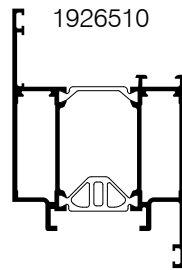
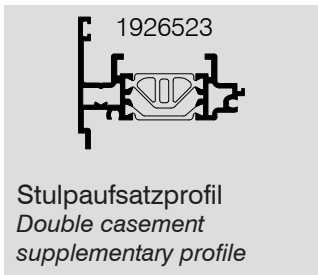

DM 35/60

DM 45/70

DM 45/70

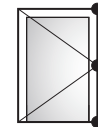
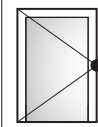
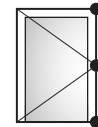
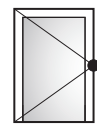
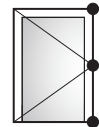
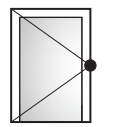

	(Pa)	400	800	400	400	800	400	400	800
	(Pa)	100	150	100	150	150	100	150	150
max.	FAB (m)	1.2	1.2	1.2	1.4	1.2	1.2	1.4	1.2
	FAH (m)	2.3*	2.52*	2.3*	2.52*	2.52*	2.3*	2.52*	2.52*
min.	GF FAB (m)	0.9	0.9	0.9	0.9	0.9	0.9	0.9	0.9
	SF FAB (m)	0.68	0.68	0.68	0.68	0.68	0.68	0.68	0.68
	FAH (m)	-	2.0	-	2.0	2.0	-	2.0	2.0
	min.	GF FAB (m)	0.9**	0.9**	0.9**	0.9**	0.9**	0.9**	0.9**
		FAH (m)	2.01**	2.01**	2.01**	2.01**	2.01**	2.01**	2.01**
	min.	GF FAB (m)	0.9***	-	0.9***	-	-	0.9***	-
		FAH (m)	2.01***	-	2.01***	-	-	2.01***	-
	max. (kg)	200		200			200		

* FAH > 2.2 m zusätzliches Mittelband erforderlich

* FAH > 2.2 m additional centre hinge required

** RC1 N ohne Beschränkung FAH

** RC1 N without restriction FAH

*** RC3 nur Teilpanik

*** RC3 partial panic!







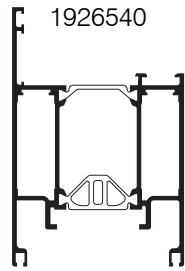

DM 35/60
Ausführung nur mit Druckstange möglich
Only version with touch-bar possible

WICSTYLE 65 evo

Pendeltüren
Double action doors

Zulässige Flügelgrößen
Admissible leaf sizes







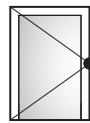
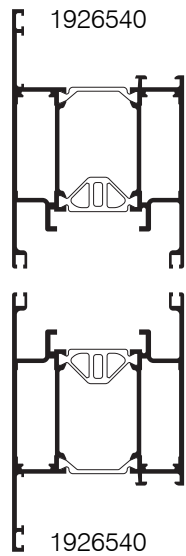
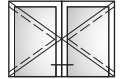

	(Pa)	400	-
	(Pa)	-	-
max.	FAB (m)	1.3	-
	FAH(m)	2.3	-
min.	GF FAB (m)	0.6	-
	SF FAB (m)	-	-
	FAH (m)	-	-
 min.	FAB (m)	-	-
	FAH (m)	-	-
 min.	FAB (m)	-	-
	FAH (m)	-	-
 max.	max.(kg)	160	-

WICSTYLE 65 evo

Pendeltüren
Double action doors

Zulässige Flügelgrößen
Admissible leaf sizes











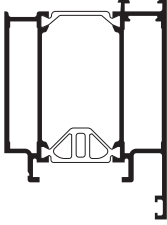
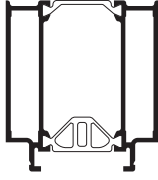
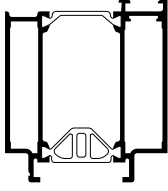

	(Pa)	400	-
	(Pa)	-	-
max.	FAB (m)	1.3	-
	FAH (m)	2.3	-
min.	GF FAB (m)	0.6	-
	SF FAB (m)	0.6	-
	FAH (m)	2.0	-
 min.	FAB (m)	-	-
	FAH (m)	-	-
 min.	FAB (m)	-	-
	FAH (m)	-	-
 max.	max.(kg)	160	-

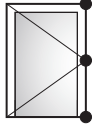
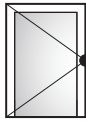
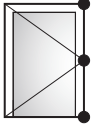
WICSTYLE 65 evo

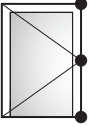
Türen mit flügelüberdeckender Füllung
Doors with leaf overlapping infill

Zulässige Flügelgrößen
Admissible leaf sizes







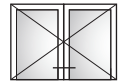

		1920516			1920512			1320034					
													
													
	(Pa)	800	400	800	800	400	800	800	400	800			
		(Pa)	150	150	150	150	150	150	150	150			
max.	FAB (m)	1.2	1.4	1.4	1.2	1.4	1.4	1.2	1.4	1.4			
	FAH (m)	2.1	2.1	2.1	2.1	2.1	2.1	2.1	2.1	2.1			
min.	GF FAB (m)	0.6	0.6	0.6	0.6	0.6	0.6	0.6	0.6	0.6			
	SF FAB (m)	-	-	-	-	-	-	-	-	-			
	FAH (m)	-	-	-	-	-	-	-	-	-			
	min. FAB (m)	-	-	-	-	-	-	-	-	-			
	FAH (m)	-	-	-	-	-	-	-	-	-			
	min. FAB (m)	-	-	-	-	-	-	-	-	-			
	FAH (m)	-	-	-	-	-	-	-	-	-			
	max. (kg)	200			200			200					

WICSTYLE 65 evo

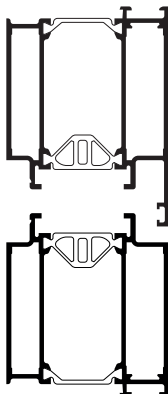
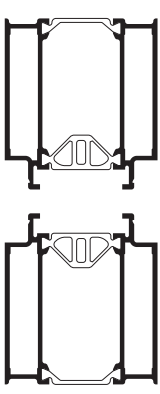
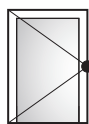
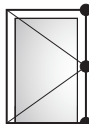
Türen mit flügelüberdeckender Füllung
Doors with leaf overlapping infill

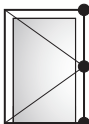
Zulässige Flügelgrößen
Admissible leaf sizes

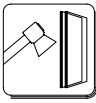

		1920516		1920512			
							
		1320034		1920512			
		 		 			
	(Pa)	400	800	400	800	-	-
		100	150	100	150	-	-
max.	FAB (m)	1.2	1.2	1.2	1.2	-	-
	FAH (m)	2.1	2.1	2.1	2.1	-	-
min.	GF FAB (m)	0.6	0.6	0.6	0.6	-	-
	SF FAB (m)	0.6	0.6	0.6	0.6	-	-
	FAH (m)	-	-	-	-	-	-
	min. FAB (m)	-	-	-	-	-	-
	FAH (m)	-	-	-	-	-	-
	min. FAB (m)	-	-	-	-	-	-
	FAH (m)	-	-	-	-	-	-
	max.(kg)	200		200		-	

WICSTYLE 65

Standard Beschläge
Standard fittings

Zulässige Flügelgrößen
Admissible sash sizes



		1926510			1926535		
		1926513			1926536		
	(Pa)	800	800	800	800	800	-
	(Pa)	150	150	300	150	200	-
max.	FAB (m)	1.2	1.2	1.2	1.2	1.5	-
	FAH (m)	2.3*	2.52*	2.2*	2.3*	2.6*	-
min.	GF FAB (m)	0.6	0.6	0.6	0.6	0.6	-
	SF FAB (m)	-	-	-	-	-	-
	FAH (m)	-	-	-	-	-	-
	min. FAB (m)	-	-	-	-	-	-
	FAH (m)	-	-	-	-	-	-
	min. FAB (m)	-	-	-	-	-	-
	FAH (m)	-	-	-	-	-	-
	max.(kg)	150			150		

* FAH > 2.2 m zusätzliches Mittelband erforderlich





* FAH > 2.2 m additional centre hinge required

WICSTYLE 65

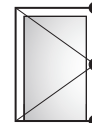
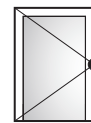
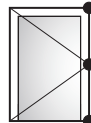
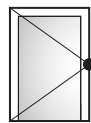
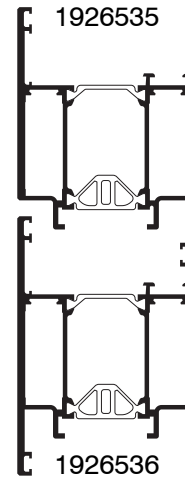
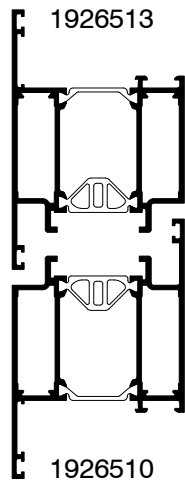
Standard Beschläge
Standard fittings

Zulässige Flügelgrößen
Admissible sash sizes



	(Pa)	400	800	400	400	800	400
	(Pa)	100	150	100	100	150	100
max.	FAB (m)	1.2	0.9	1.2	1.2	0.9	1.2
	FAH (m)	2.3*	2.2	2.52*	2.3*	2.2	2.52*
min.	GF FAB (m)	0.6	0.6	0.6	0.6	0.6	0.6
	SF FAB (m)	0.6	0.6	0.6	0.6	0.6	0.6
	FAH (m)	-	-	-	-	-	-
	min. FAB (m)	-	-	-	-	-	-
	FAH (m)	-	-	-	-	-	-
	min. FAB (m)	-	-	-	-	-	-
	FAH (m)	-	-	-	-	-	-
	max. (kg)	200			200		

* FAH > 2.2 m zusätzliches Mittelband erforderlich





* FAH > 2.2 m additional centre hinge required

WICSTYLE 65

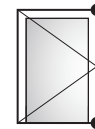
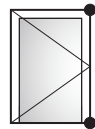
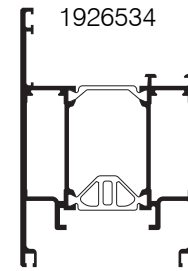
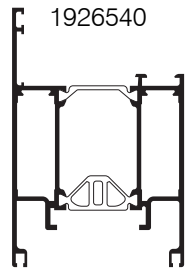
Pendeltür Beschläge
Double action door fittings

Zulässige Flügelgrößen
Admissible sash sizes







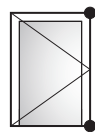
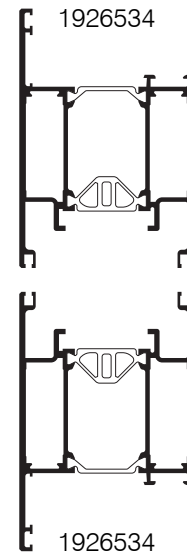
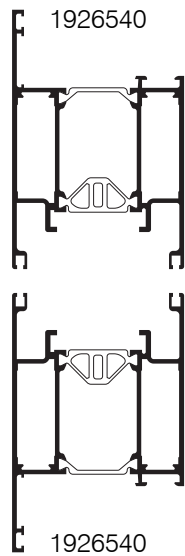
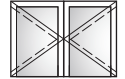

	(Pa)	800	800
	(Pa)	-	-
max.	FAB (m)	1.3	1.3
	FAH(m)	2.52	2.52
min.	GF FAB (m)	0.6	0.6
	SF FAB (m)	-	-
	FAH (m)	-	-
	min. FAB (m)	-	-
	FAH (m)	-	-
	min. FAB (m)	-	-
	FAH (m)	-	-
	max.(kg)	160	160

WICSTYLE 65

Pendeltür Beschläge
Double action door fittings

Zulässige Flügelgrößen
Admissible sash sizes





	(Pa)	800	800
	(Pa)	-	-
max.	FAB (m)	1.3	1.3
	FAH(m)	2.52	2.52
min.	GF FAB (m)	0.6	0.6
	SF FAB (m)	0.6	0.6
	FAH (m)	2.0	2.0
	min. FAB (m)	-	-
	FAH (m)	-	-
	min. FAB (m)	-	-
	FAH (m)	-	-
	max.(kg)	160	160

	Seite <i>Page</i>
Glasleistenprofile <i>Glazing bead profiles</i>	4/3
Zusatzprofile <i>Additional profiles</i>	4/9
Eckwinkelprofile <i>Corner angle profiles</i>	4/15

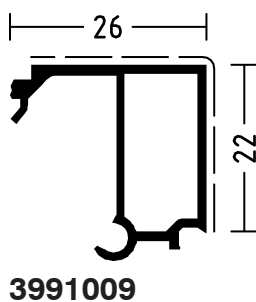
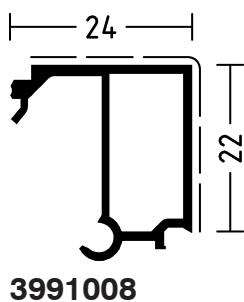
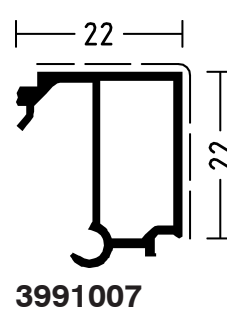
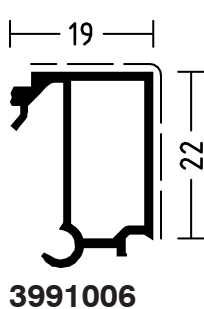
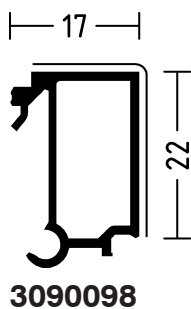
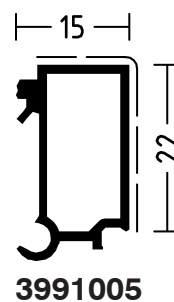
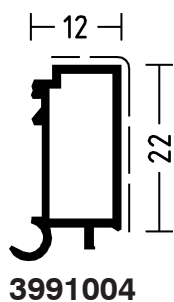
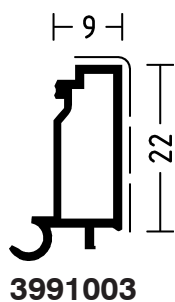
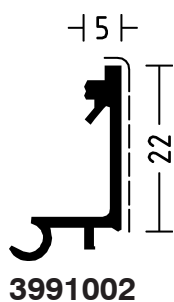
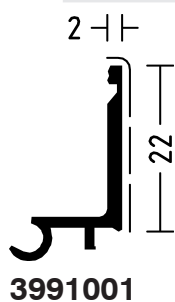
	 m	 mm	 mm
3991001	6,5	89	22
3991002	6,5	100	22
3090099	6,5	108	21
3991003	6,5	90	28
3991004	6,5	92	31
3991005	6,5	95	34
3090098	6,5	105	35
3991006	6,5	110	38
3991007	6,5	116	41
3991008	6,5	120	43
3991009	6,5	124	45



	 m	 mm	 mm
3991010	6,5	130	48
3991011	6,5	136	51
3991012	6,5	140	53
3991013	6,5	146	56
3991014	6,5	154	60
3991015	6,5	162	64
3991016	6,5	170	68
3991017	6,5	176	71

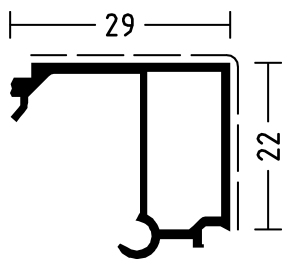

3991010

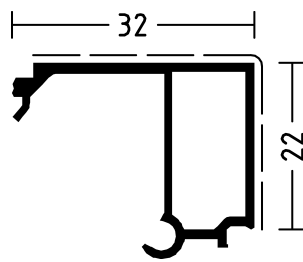

3991011

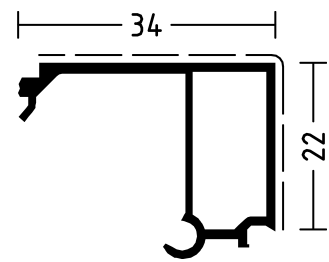

3991012

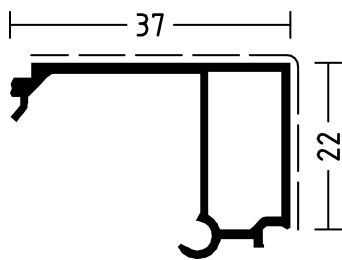

3991013

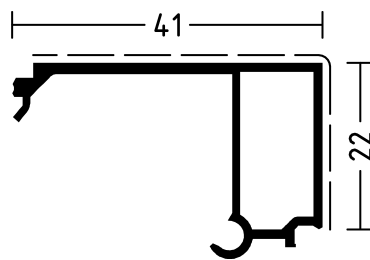

3991014

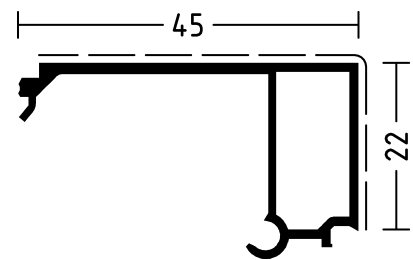

3991015

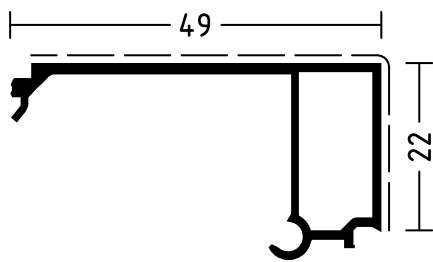

3991016

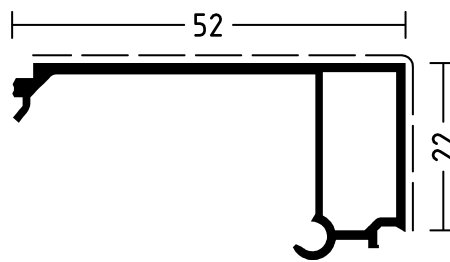

3991017

	 m	 mm	 mm
3991022	6,5	92	18
3991023	6,5	82	24
3991024	6,5	84	27
3991025	6,5	87	30
3991026	6,5	102	34
3991027	6,5	108	37
3991028	6,5	112	39
3991029	6,5	116	41
3991030	6,5	122	44
3991031	6,5	128	47
3991032	6,5	132	49

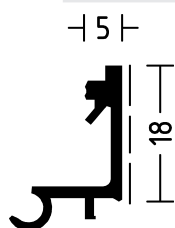

3991022

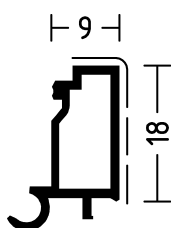

3991023

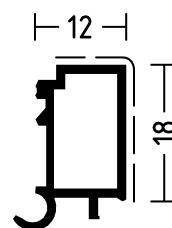

3991024

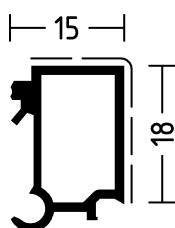

3991025

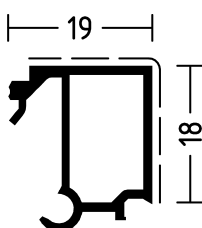

3991026

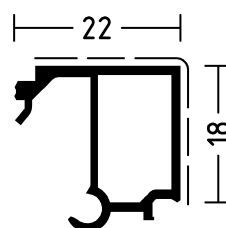

3991027

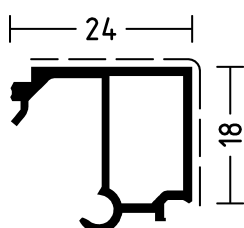

3991028

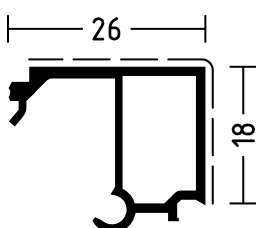

3991029

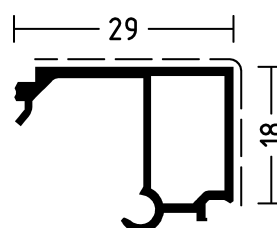

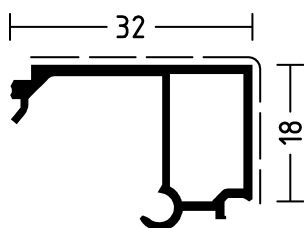

3991030

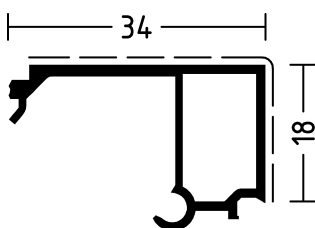

3991031



3991032

	 m	 mm	 mm
3991033	6,5	138	52
3991034	6,5	146	56
3991035	6,5	154	60
3991036	6,5	162	64
3991037	6,5	168	67

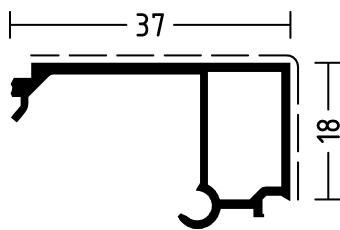

3991033

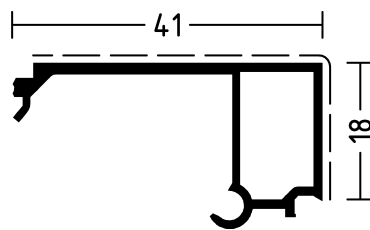

3991034

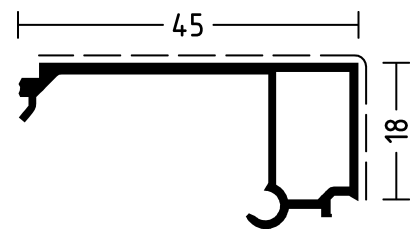

3991035

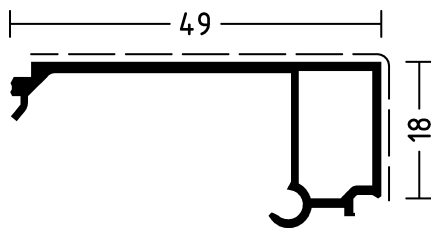

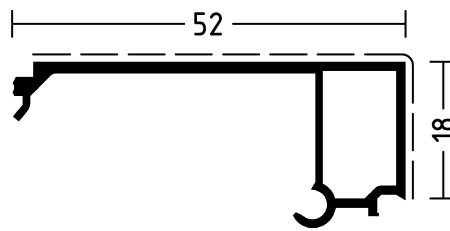

3991036

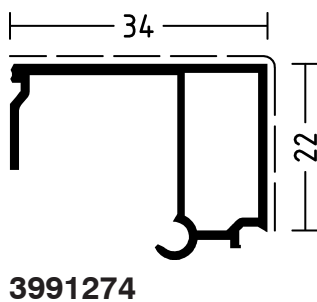
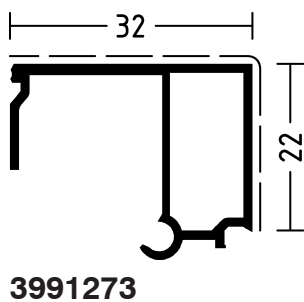
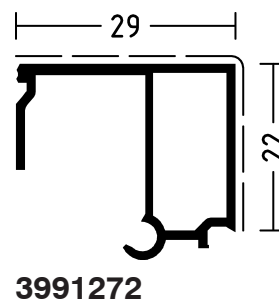
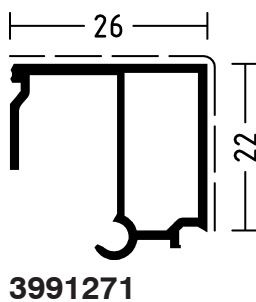
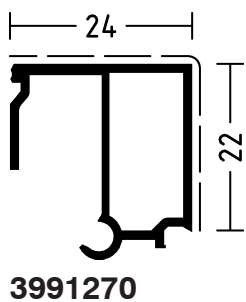
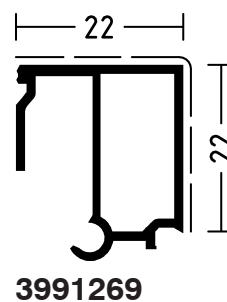
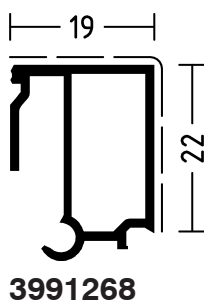
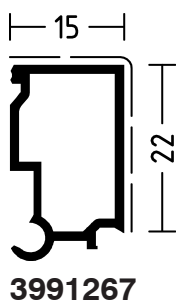
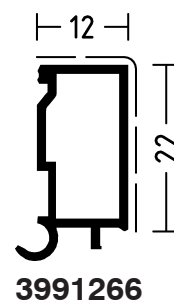
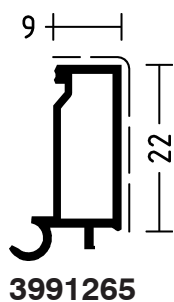
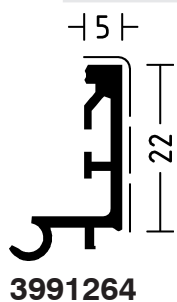

3991037

	 m	 mm	 mm
3991264	6,5	116	27
3991265	6,5	90	31
3991266	6,5	92	34
3991267	6,5	92	37
3991268	6,5	124	41
3991269	6,5	130	44
3991270	6,5	134	46
3991271	6,5	138	48
3991272	6,5	144	51
3991273	6,5	150	54
3991274	6,5	154	56



		m	mm	mm
3991275		6,5	160	59
3991276		6,5	164	63
3991277		6,5	172	67
3991278		6,5	180	71
3991279		6,5	186	74

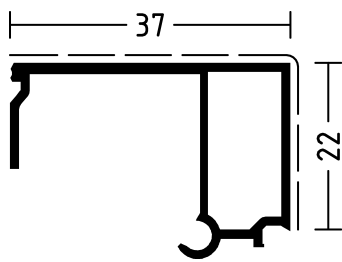

3991275

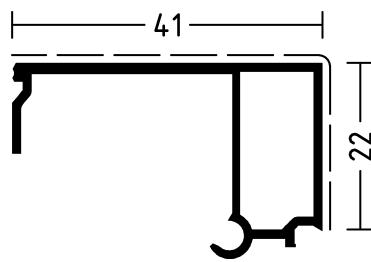

3991276

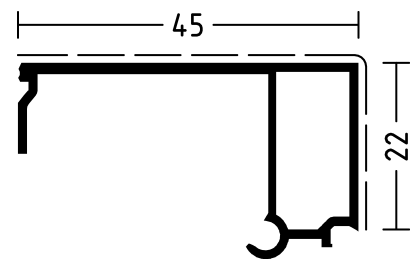

3991277

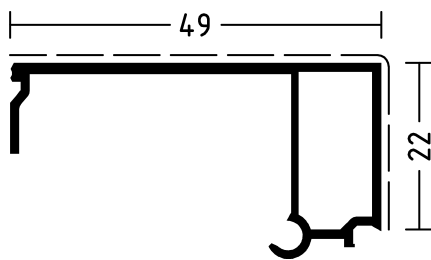

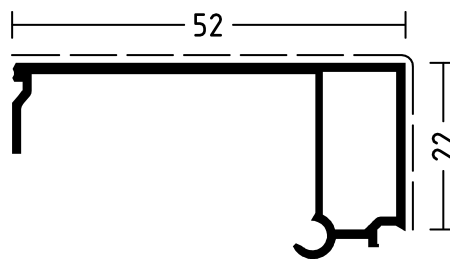

3991278



3991279

WICSTYLE 75 evo / 65 evo / 65

Zusatzprofile
Additional profiles

	 m	 mm	 mm
3091052	6	73	37
3091053	6	76	0

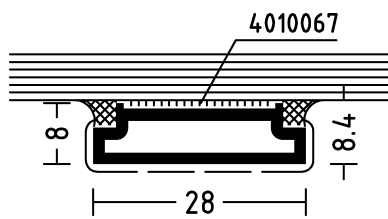

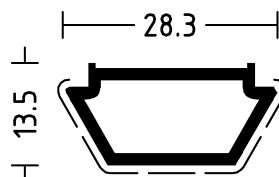

3091052

Ziersprossenprofil
Glazing bar profile





3091053

Ziersprossenprofil
Glazing bar profile

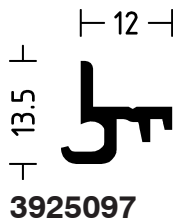
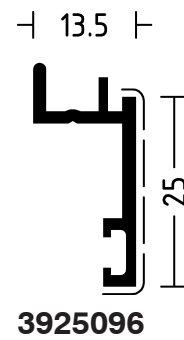
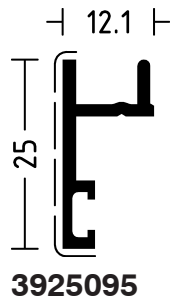
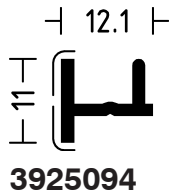
	 m	 mm	 mm
3925094	6,5	55	11
3925095	6,5	97	25
3925096	6,5	109	25
3925097	6,5	37	0



	 m	 mm	 mm
3991213	6,5	103	25
3991214	6,5	113	25
3991220	6,5	98	15

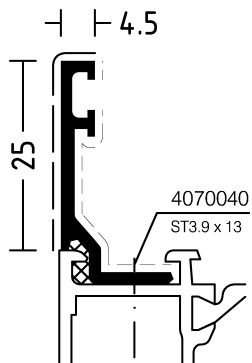

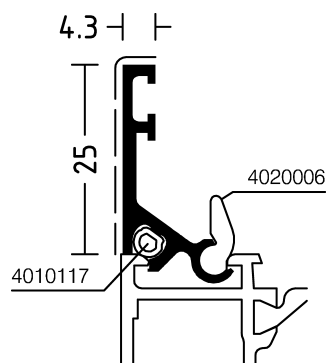

3991213
Falzprofil
Rebate profile

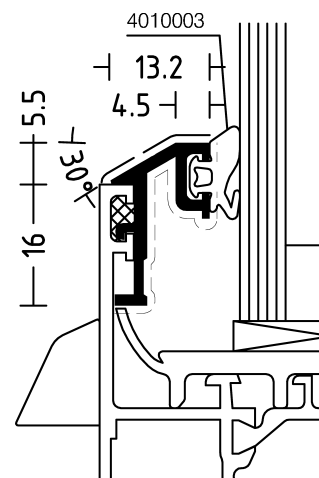

3991214
Glasleistenprofil
Glazing bead profile



3991220
Glasleistenprofil, für Klassik-Design, aus Vormaterial 3991212, Einsatz nur mit Mitteldichtung und Formecken / Eckvulkanisierter Dichtungsrahmen
Glazing bead profile, for classic design, from prematerial 3991212, usage only with centre gasket and moulded gasket angle / corner vulcanized gasket frame

	 m	 mm	 mm
3991257	6,5	205	107
3991253	6,5	216	113
3991255	6,5	221	123

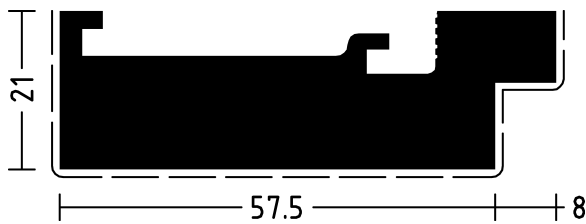

3991257

Verwendung: Kombinationsblendrahmen
auswärts,
1916004/1926522, 1917004/1927522
Application: Combinations frame outwards,
1916004/1926522, 1917004/1927522

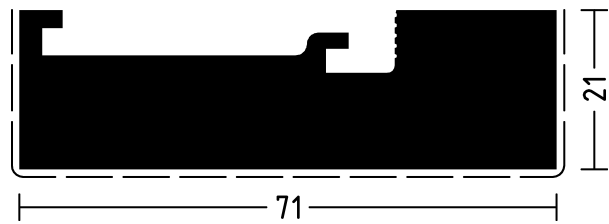

3991253

Verwendung:
1916004, 1917004
Application:
1916004, 1917004

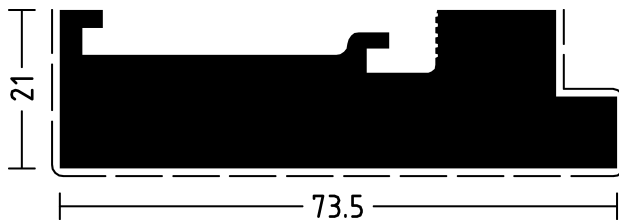



3991255

Verwendung: Kombinationsblendrahmen
einwärts,
1916004/1926520, 1917004/1927520

Application: Combinations frame inwards,
1916004/1926520, 1917004/1927520

WICSTYLE 75 evo / 65 evo

Zusatzprofile
Additional profiles

	 m	 mm	 mm
3991256	6,5	253	131
3090244	6,5	317	154

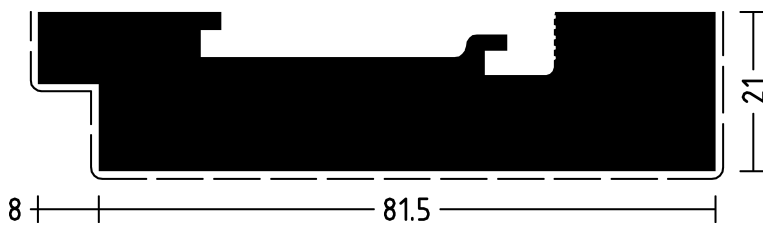



3991256

Verwendung:
1926511, 1927511

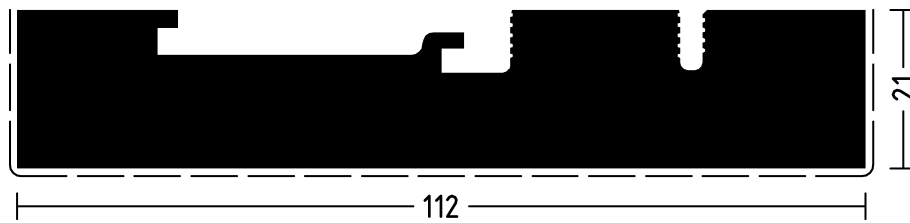
Application:
1926511, 1927511



3090244

	 m	 mm	 mm
3991258	6,5	337	172
3991259	3	447	219

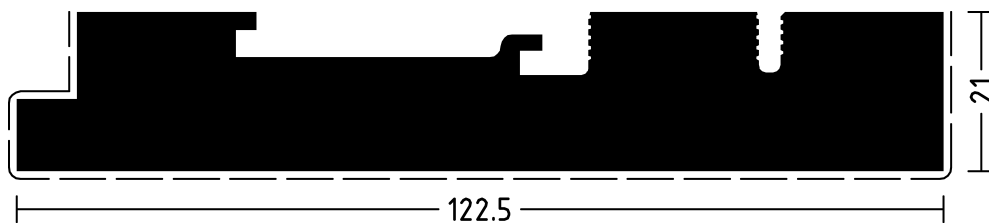

3991258

Verwendung:

1926514, 1927514,

Türsockel auswärts, mit umlaufendem Türflügel,

1926514, 1926517, 1927514, 1927517,

Türsockel einwärts, mit umlaufendem Türflügel, besäumt,

1926511, 1926517, 1927511, 1927517

Application:

1926514, 1927514,

door bottom rail, outwards, with circumferential leaf profil,

1926514, 1926517, 1927514, 1927517,

door bottom rail, inwards, with circumferential leaf profil, trimmed,

1926511, 1926517, 1927511, 1927517

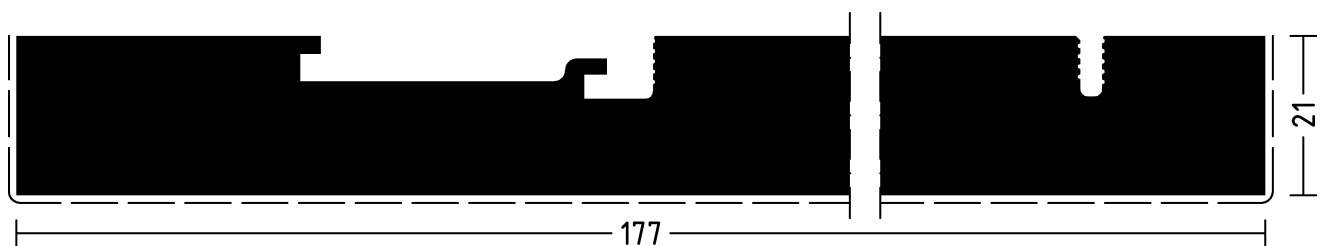

3991259

Verwendung:

1916209, 1926518, 1917209, 1927518,

Verwendung besäumt:

Tür-/Festfeldsockel einwärts,

Tür-/Festfeld- Kämpfersockel ein-/auswärts

Application:



1916209, 1926518, 1917209, 1927518,

Application trimmed:

Door-/fixed field with bottom rail profil inwards,

Door-/fixed field with transom as bottom rail

profil, inwards/outwards

			
	m	mm	mm
3900030	3	235	0
3000074	3	242	0
3900048	3	291	0
3900049	3	325	0

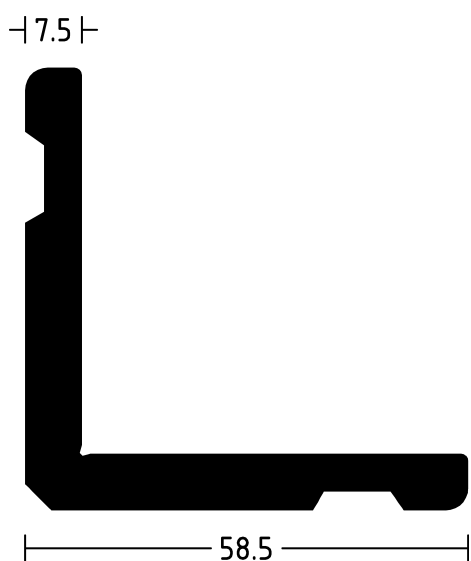

3900030

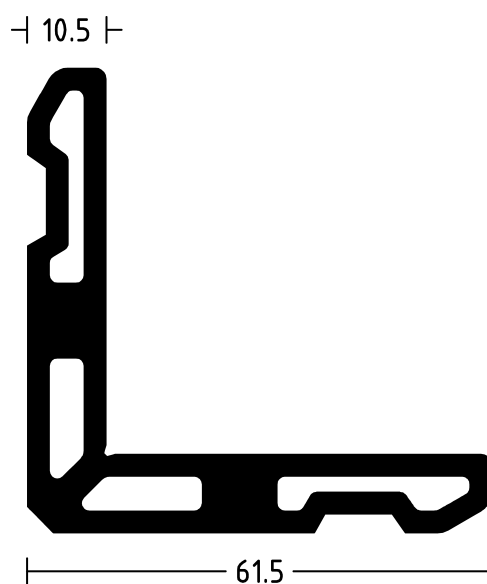

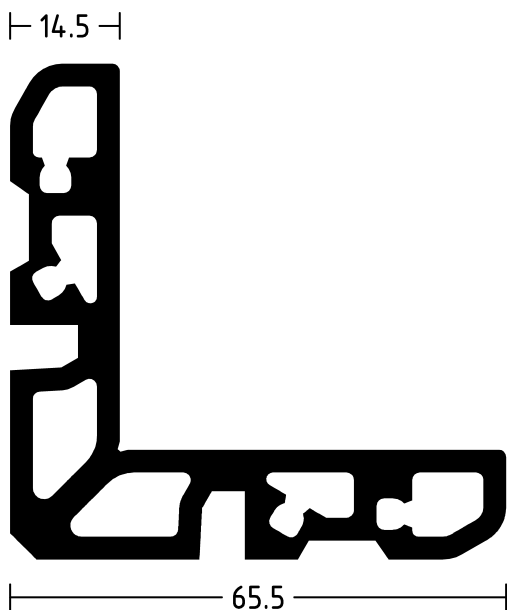

3000074

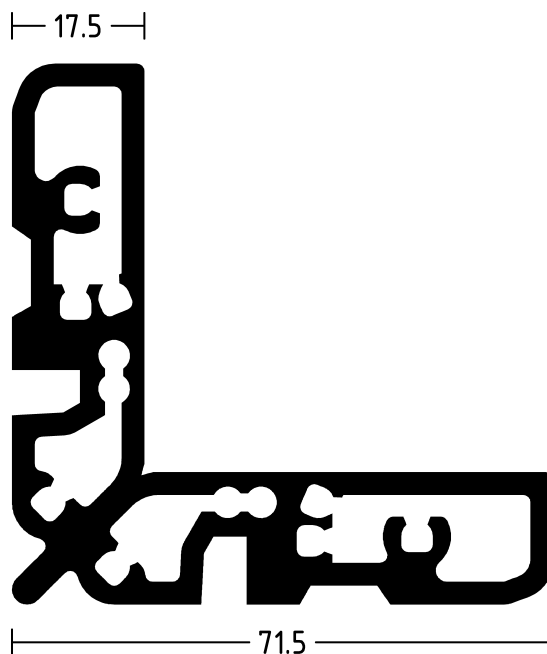

3900048



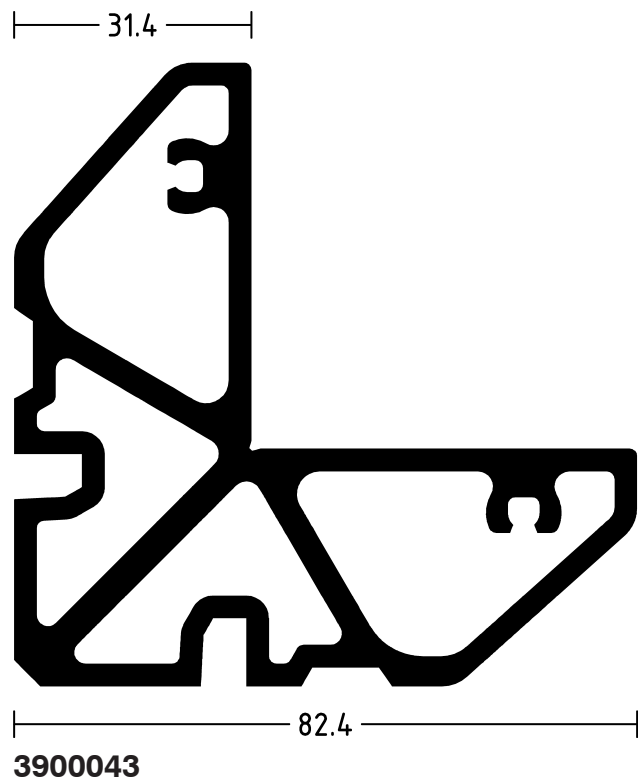
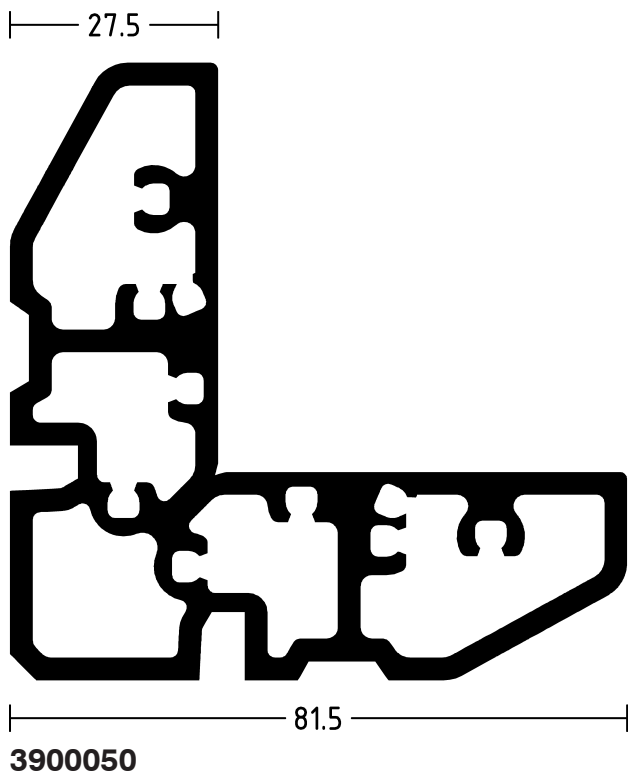

3900049

	 m	 mm	 mm
3900050	3	342	0
3900043	3	338	0



WICSTYLE 75 evo / 65 evo / 65

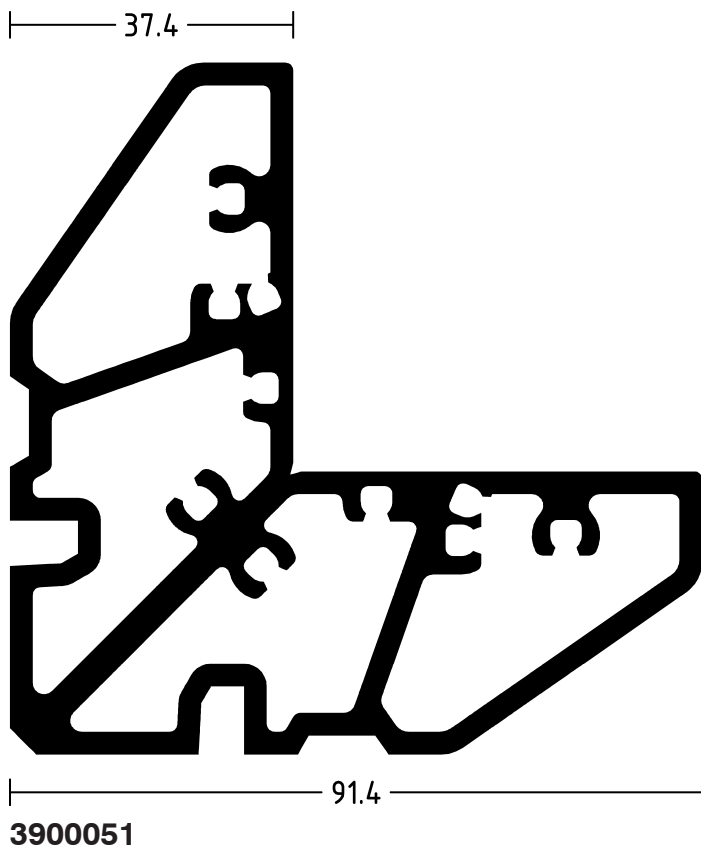

Eckwinkelprofile
Corner angle profiles

			
	m	mm	mm
3900051	3	369	0



WICSTYLE 75 evo / 65 evo / 65

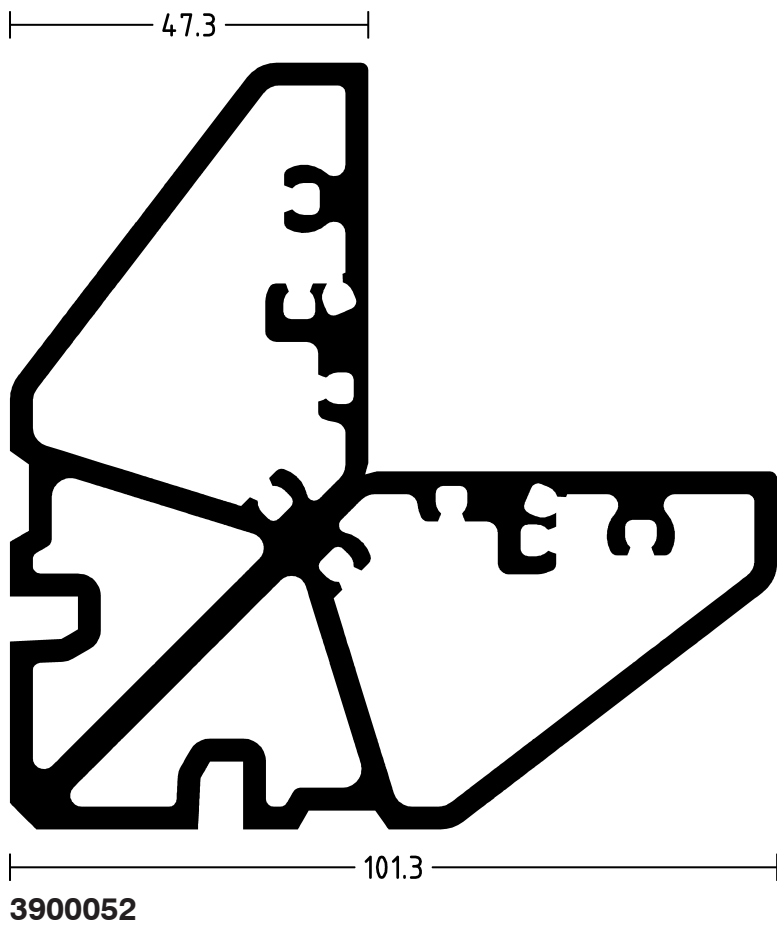

Eckwinkelprofile
Corner angle profiles

			
	m	mm	mm
3900052	3	397	0



WICSTYLE 75 evo / 65 evo / 65

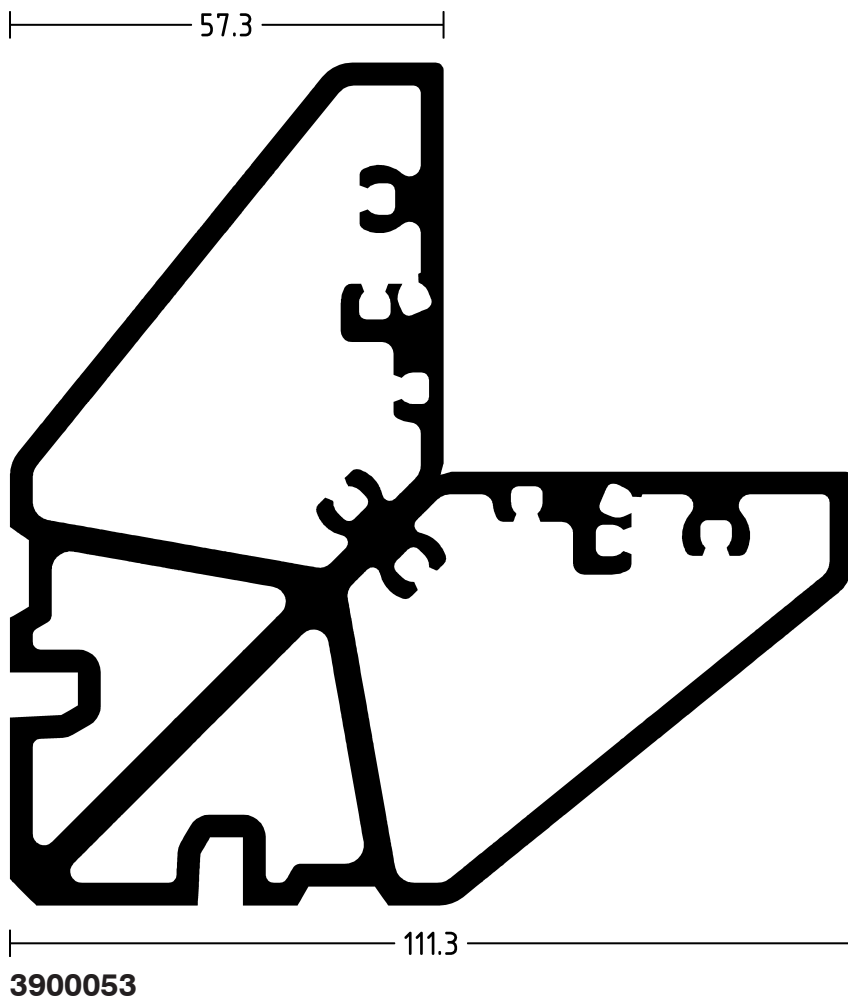

Eckwinkelprofile
Corner angle profiles

	 m	 mm	 mm
3900053	3	425	0



WICSTYLE 75 evo / 65 evo / 65

Eckwinkelprofile
Corner angle profiles

	 m	 mm	 mm
3900044	3	430	0

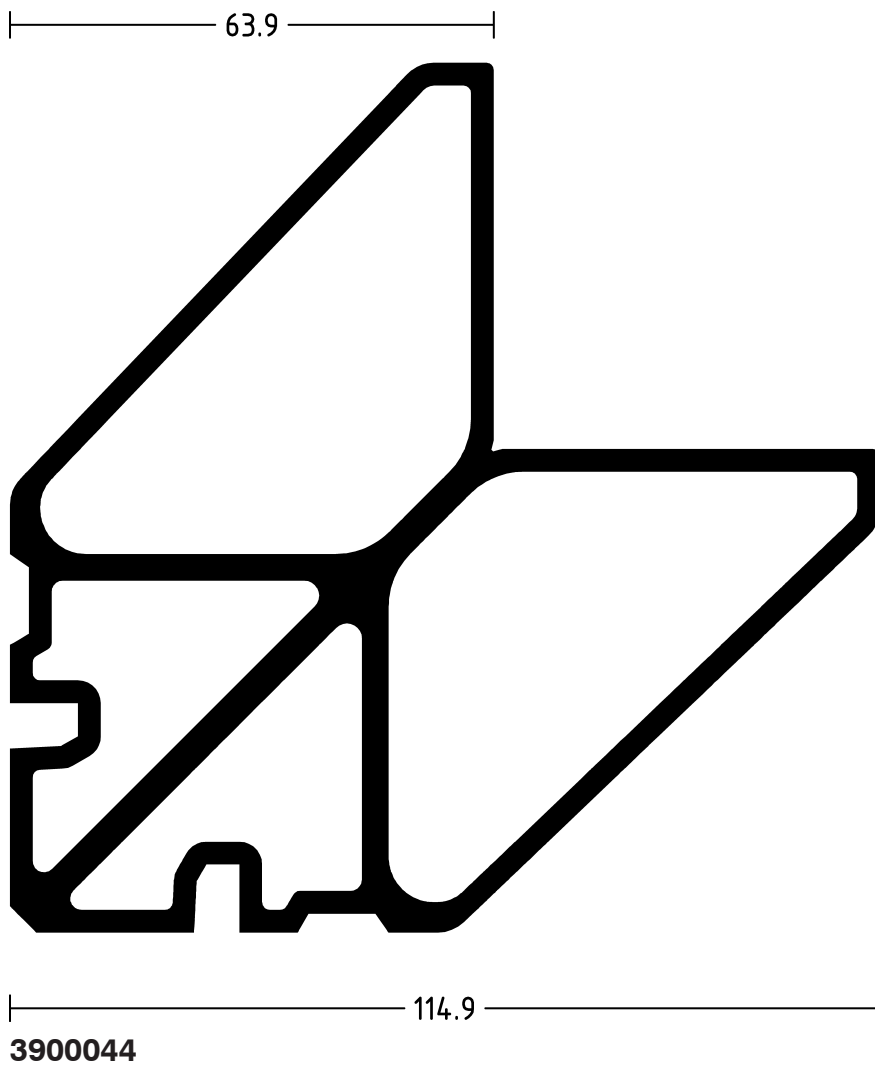

	Seite Page
Übersicht Zubehör <i>Survey of accessories</i>	5/3
Dichtungen Meterware <i>Gaskets metre ware</i>	5/14
Dichtungen Stückware <i>Gaskets single parts</i>	5/25
Kunststoffteile Formstücke <i>Plastic parts single</i>	5/34
Eckwinkel / Blechteile <i>Corner angles / Metal sheet parts</i>	5/47
Verbinder <i>Butt-joint connectors</i>	5/54
Verbindungselemente / Schrauben <i>Connecting components / Screws</i>	5/66
Verschiedenes <i>Miscellaneous</i>	5/70
Schrauben-Tabellen <i>Screw tables</i>	5/72

WICSTYLE 75 evo / 65 evo / 65

Übersicht Zubehör *Survey of accessories*

Technische Information
Technical information

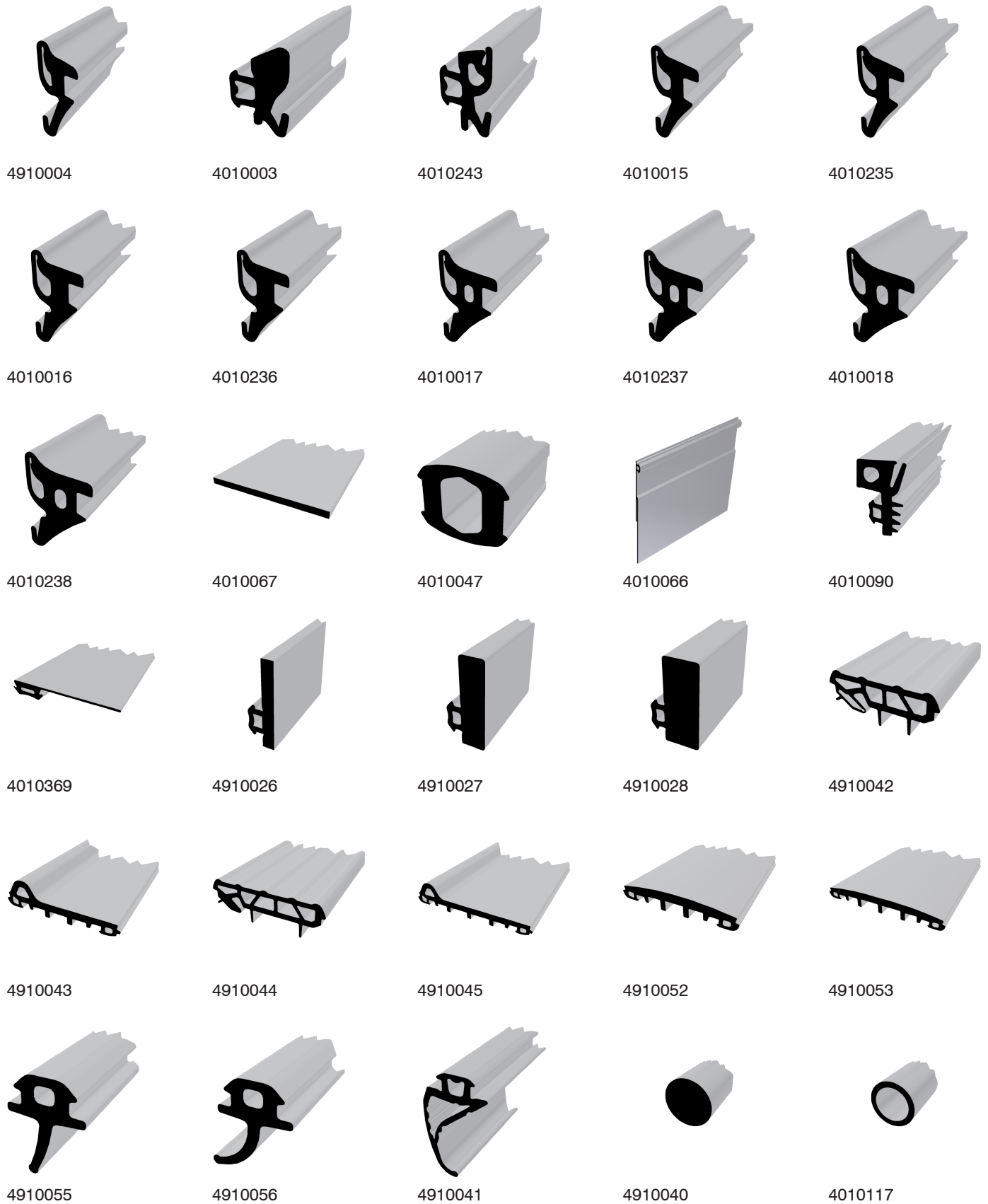

WICSTYLE 75 evo / 65 evo / 65

Technische Information
Technical information

Übersicht Zubehör
Survey of accessories

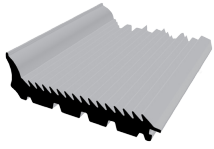

4910074

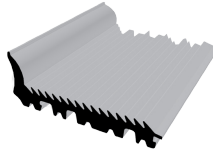

4910076



4910082

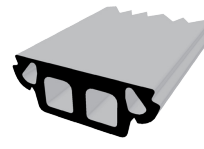

4910086

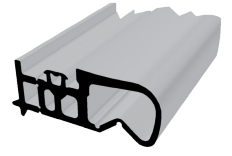

4910089

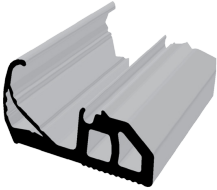

4910091

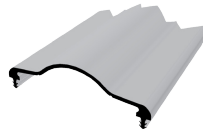

4910094



4010131



4010132



4010556

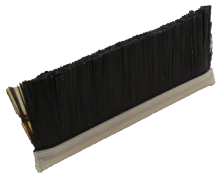

4910096



4910097



4910095

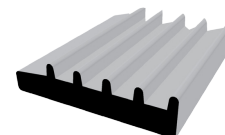

4990002

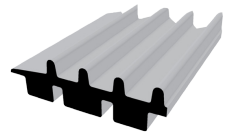

4990003

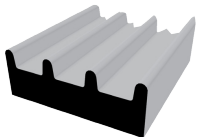

4990009

WICSTYLE 75 evo / 65 evo / 65

Technische Information
Technical information

Übersicht Zubehör
Survey of accessories



4020006

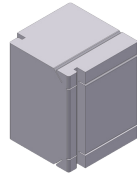

4020621

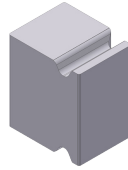

4020622

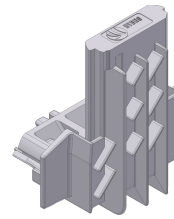

4920021

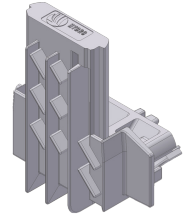

4920022

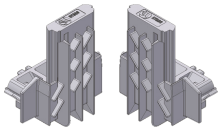

4920023

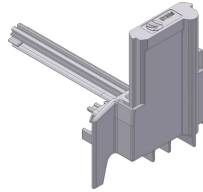

4920024

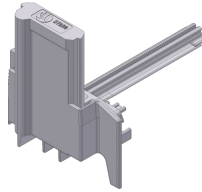

4920025

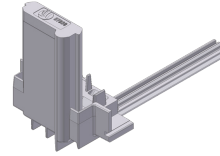

4920026

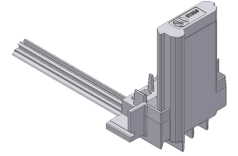

4920027

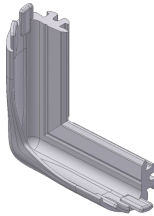

4920028

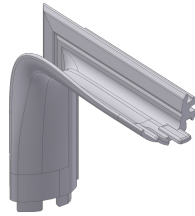

4920029

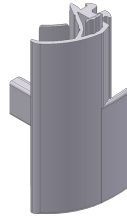

4920030

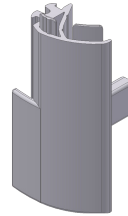

4920031

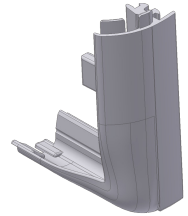

4920032

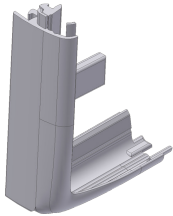

4920033

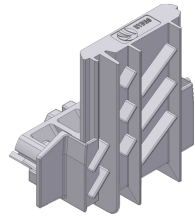

4920034

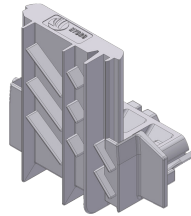

4920035

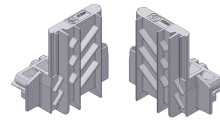

4920036

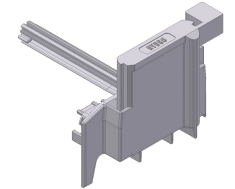

4920037

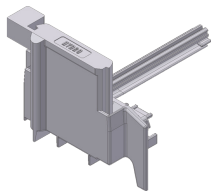

4920038

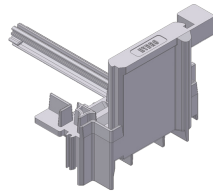

4920039

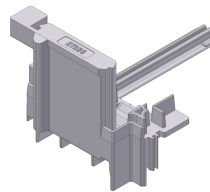

4920040

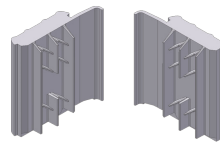

4920044

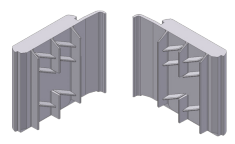

4920047

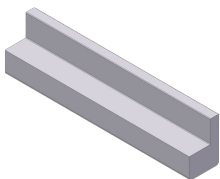

4920060

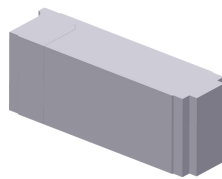

4920100

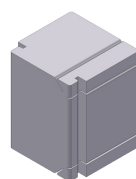

4920101

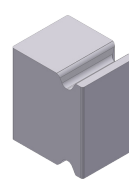

4920102

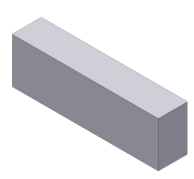

4920103

WICSTYLE 75 evo / 65 evo / 65

Technische Information
Technical information

Übersicht Zubehör
Survey of accessories

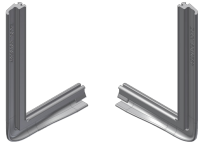

4920110

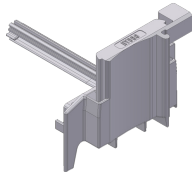

4920117

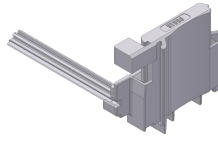

4920118

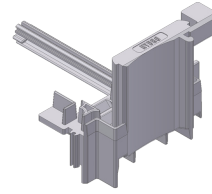

4920119

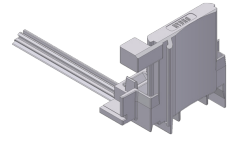

4920120

WICSTYLE 75 evo / 65 evo / 65

Technische Information
Technical information

Übersicht Zubehör
Survey of accessories



4020049

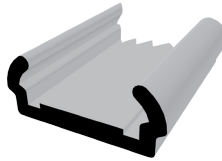

4030019

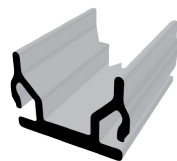

4030031



4940079



4040026



4040027



4040028

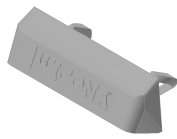

4040610

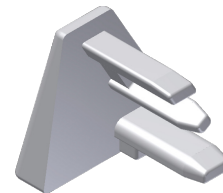

4040029

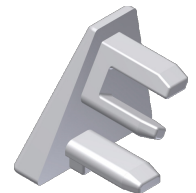

4040030

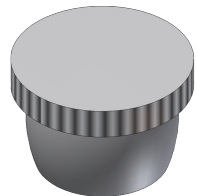

4040086



4040088

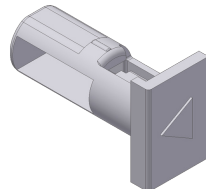

4070030

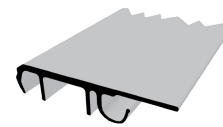

4930048



4930049



4930050

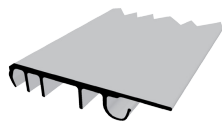

4930051



4930052

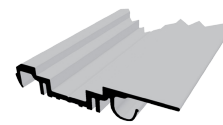

4930053

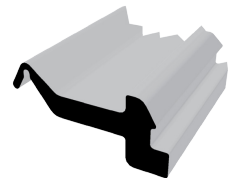

4930067

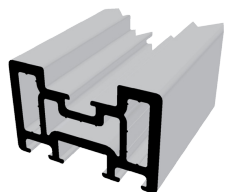

4930068

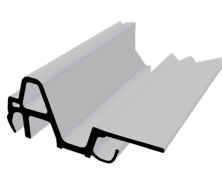

4930076

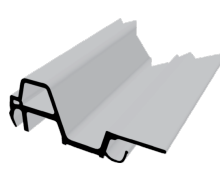

4930077

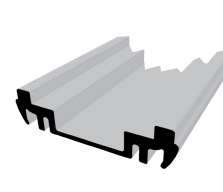

4930084

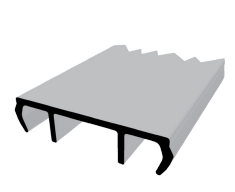

4930085

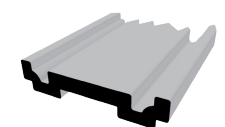

4930086



4930089



4930090



4930098



4930099

WICSTYLE 75 evo / 65 evo / 65

Technische Information
Technical information

Übersicht Zubehör
Survey of accessories

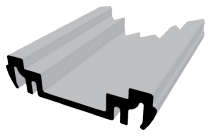

4930100

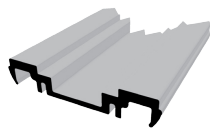

4930101



4930111

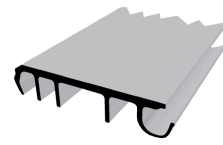

4930112



4940077

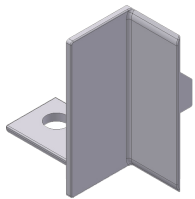

4940143

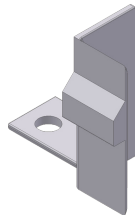

4940144

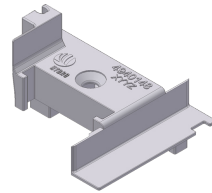

4940148

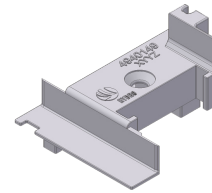

4940149

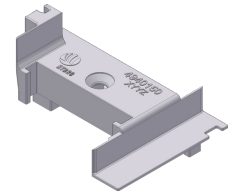

4940150

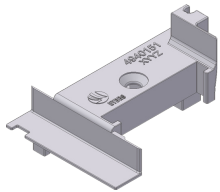

4940151



4940152

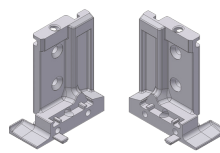

4940155

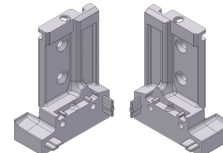

4940158

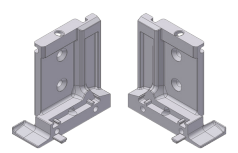

4940161

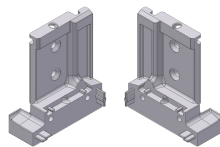

4940164



4940170



4940171

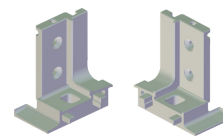

4940473

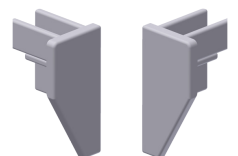

4940482

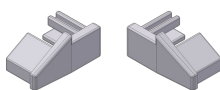

4940485

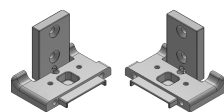

4940506

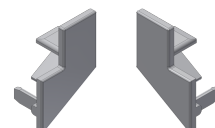

4040807



4940538

WICSTYLE 75 evo / 65 evo / 65

Technische Information
Technical information

Übersicht Zubehör
Survey of accessories



4050587

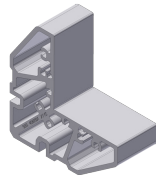

4050591



4950005



4950006



4950007



4950008

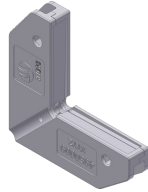

4950009

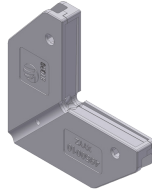

4950010

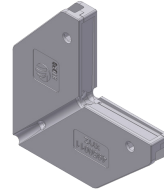

4950011

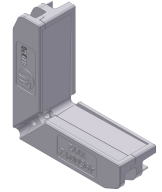

4950012

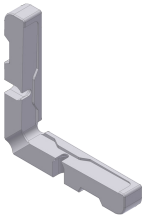

4950013

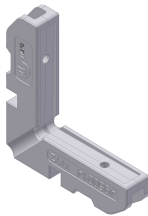

4950014

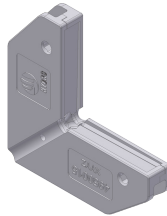

4950015

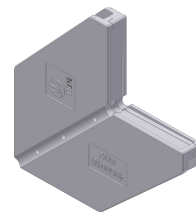

4950016

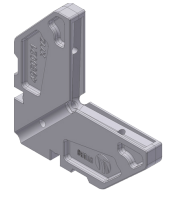

4950021

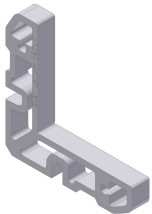

4950057



4950058

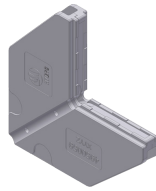

4950059



4950060



4950061



4950062



4950063

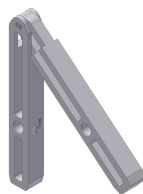

4950076

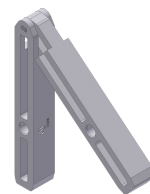

4950077

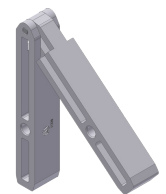

4950078

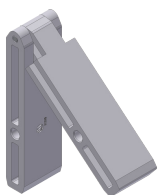

4950079

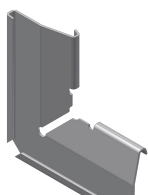

4950082

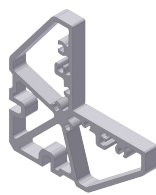

4950328

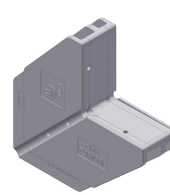

4950352

WICSTYLE 75 evo / 65 evo / 65

Technische Information
Technical information

Übersicht Zubehör
Survey of accessories

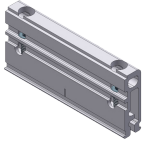

4060411

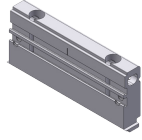

4060413



4960002

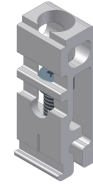

4960003

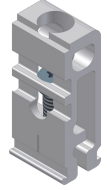

4960004

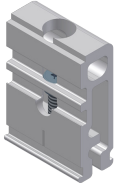

4960005

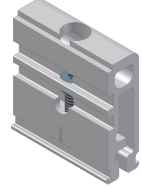

4960006

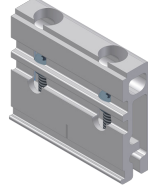

4960007

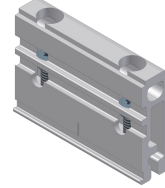

4960008

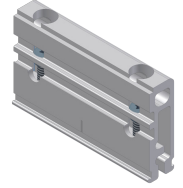

4960009

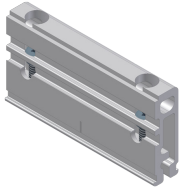

4960010

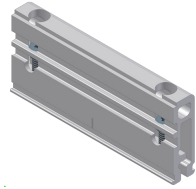

4960011

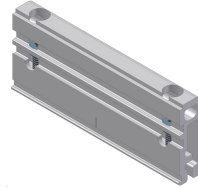

4960012

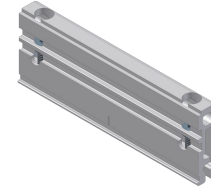

4960013

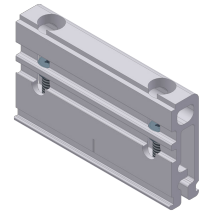

4960014

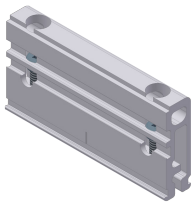

4960015

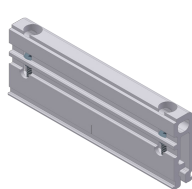

4960016

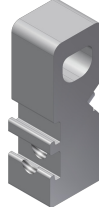

4960035



4960037

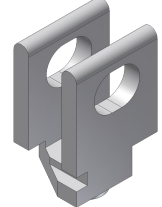

4060056

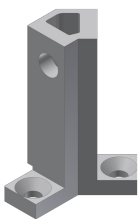

4960050

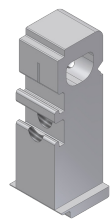

4960052

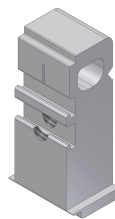

4960053

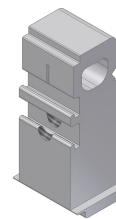

4960054

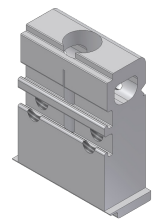

4960055

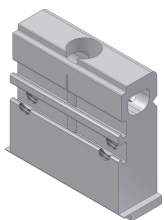

4960056

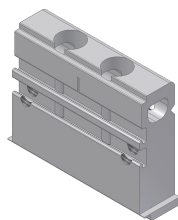

4960057

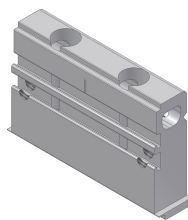

4960058

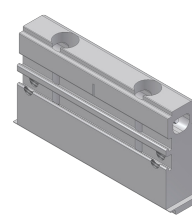

4960059

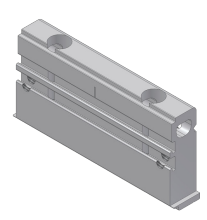

4960060

WICSTYLE 75 evo / 65 evo / 65

Technische Information
Technical information

Übersicht Zubehör
Survey of accessories

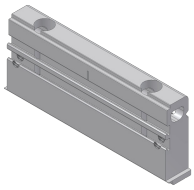

4960061

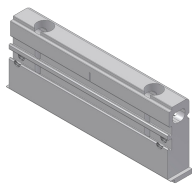

4960062

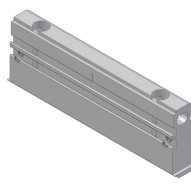

4960063

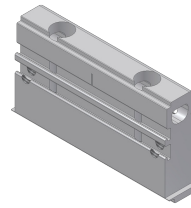

4960064

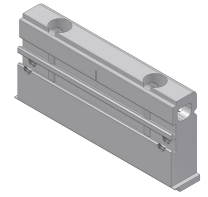

4960065

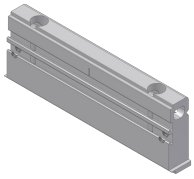

4960066

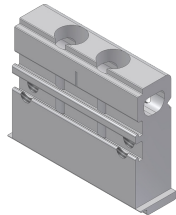

4960067

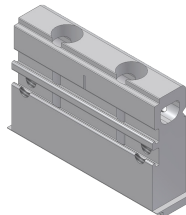

4960068

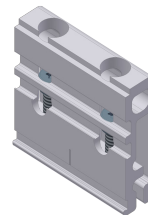

4960069

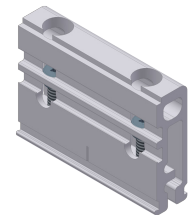

4960070

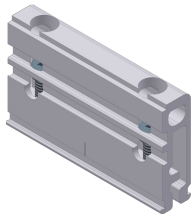

4960071

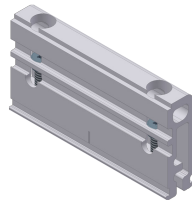

4960072



4960040



4960041



4960042



4960043



4960045



4960046



4960047

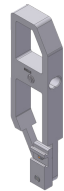

4960048

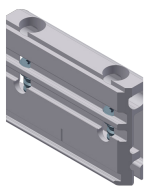

4960201

WICSTYLE 75 evo / 65 evo / 65

Technische Information
Technical information

Übersicht Zubehör
Survey of accessories



198057



4070000



4070002



186131

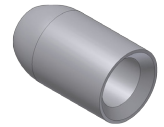

4070008



4070009



4070010



4070011



4070012



4070017



4070013



4070036



4070448



4970073



4970077



4970078



4970079



4970072

WICSTYLE 75 evo / 65 evo / 65

Technische Information
Technical information

Übersicht Zubehör
Survey of accessories



4080446



4080447



4080448



4090001



4900188

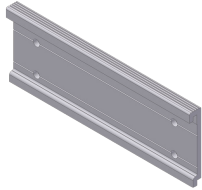

4980067

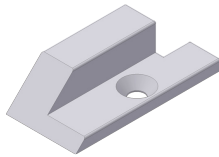

4980084

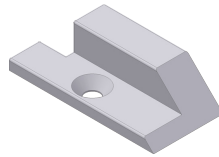





4980085

WICSTYLE 75 evo / 65 evo / 65

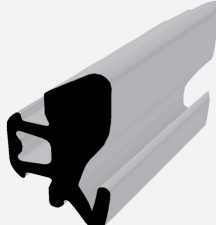
Zubehör
Accessories



Dichtungen Meterware
Gaskets metre ware

Artikel Article	VE PU	Anwendung Application	Bezeichnung / Hinweise Designation / Indications	Abbildung Figure
		Material / Material Farbe / Colour	Zuordnung Assignment	
4910004	200 m 200 m	WICSTYLE 65	Dichtung Verglasungsdichtung innen. Spalt 4 mm. Dichtung umlaufend, Stoß oben horizontal.	
		EPDM	Glazing Inner glazing gasket. Gap 4 mm.	
		schwarz black	Perimetric gasket, butt joint top horizontal.	
4010003	200 m 200 m	WICSTYLE 65 WICSTYLE 65evo WICSTYLE 75evo	Verglasungsdichtung Verglasungsdichtung außen. Spalt 4 mm. Dichtung umlaufend. Stoß oben horizontal.	
		EPDM, geschäumt EPDM, foamed	External glazing gasket Outer glazing gasket. Gap 4 mm.	
		schwarz black	Perimetric gasket. Butt joint top horizontal.	
4010243	200 m 200 m	WICSTYLE 65	Verglasungsdichtung Verglasungsdichtung außen. Spalt 4 mm. Dichtung umlaufend. Stoß oben horizontal.	
		EPDM	Glazing gasket, grey EPDM Outer glazing gasket. Gap 4 mm.	
		grau grey	Perimetric gasket. Top horizontal joint.	
4010015	200 m 200 m	WICSTYLE 65 WICSTYLE 65evo WICSTYLE 75evo	Dichtung Verglasungsdichtung innen. Spalt 5 mm. Dichtung umlaufend. Stoß oben horizontal. Kennzeichen 2 x blau.	
		EPDM	Gasket Inner glazing gasket. Gap 5 mm.	
		schwarz black	Perimetric gasket. Butt joint top horizontal. Marked with 2 x blue.	
4010235	200 m 200 m	WICSTYLE 65	Dichtung Verglasungsdichtung innen. Spalt 5 mm. Dichtung umlaufend. Stoß oben horizontal. Kennzeichen 2 x blau.	
		EPDM	Gasket Inner glazing gasket. Gap 5 mm.	
		grau grey	Perimetric gasket. Top horizontal joint. Marked with 2 x blue.	

WICSTYLE 75 evo / 65 evo / 65

Zubehör
Accessories

Dichtungen Meterware
Gaskets metre ware

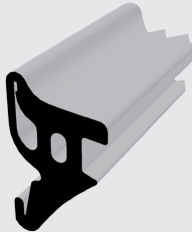
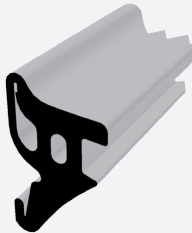
Artikel Article	VE PU	Anwendung Application	Bezeichnung / Hinweise Designation / Indications	Abbildung Figure
		Material / Material Farbe / Colour	Zuordnung Assignment	
4010016	200 m 200 m	WICSTYLE 65 WICSTYLE 65evo WICSTYLE 75evo	Dichtung Verglasungsdichtung innen. Spalt 6 mm. Dichtung umlaufend. Stoß oben horizontal. Kennzeichen 2 x rot.	
		EPDM	Gasket Inner glazing gasket. Gap 6 mm.	
		schwarz black	Perimetric gasket. Butt joint top horizontal. Marked with 2 x red.	
4010236	200 m 200 m	WICSTYLE 65	Dichtung Verglasungsdichtung innen. Spalt 6 mm. Dichtung umlaufend. Stoß oben horizontal. Kennzeichen 2 x rot.	
		EPDM	Gasket Inner glazing gasket. Gap 6 mm.	
		grau grey	Perimetric gasket. Top horizontal joint. Marked with 2 x red.	
4010017	200 m 200 m	WICSTYLE 65 WICSTYLE 65evo WICSTYLE 75evo	Dichtung Verglasungsdichtung innen. Spalt 7 mm. Dichtung umlaufend. Stoß oben horizontal. Kennzeichen 2 x grün.	
		EPDM	Gasket Inner glazing gasket. Gap 7 mm.	
		schwarz black	Perimetric gasket. Butt joint top horizontal. Marked with 2 x green.	
4010237	200 m 200 m	WICSTYLE 65	Dichtung Verglasungsdichtung innen. Spalt 7 mm. Dichtung umlaufend. Stoß oben horizontal. Kennzeichen 2 x grün.	
		EPDM	Gasket Inner glazing gasket. Gap 7 mm.	
		grau grey	Perimetric gasket. Top horizontal joint. Marked with 2 x green.	

WICSTYLE 75 evo / 65 evo / 65

Zubehör
Accessories

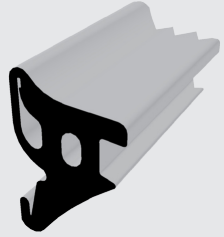
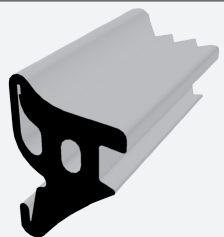
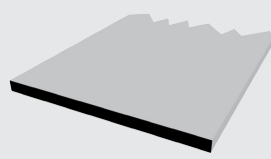
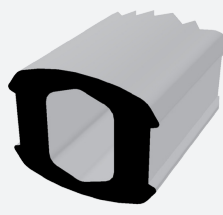

Dichtungen Meterware
Gaskets metre ware

Artikel Article	VE PU	Anwendung Application	Bezeichnung / Hinweise Designation / Indications	Abbildung Figure
		Material / Material Farbe / Colour	Zuordnung Assignment	
4010018	200 m 200 m	WICSTYLE 65 WICSTYLE 65evo WICSTYLE 75evo	Dichtung Verglasungsdichtung innen. Spalt 8 mm. Dichtung umlaufend. Stoß oben horizontal. Kennzeichen 2 x weiß.	
		EPDM	Gasket Inner glazing gasket. Gap 8 mm.	
		schwarz black	Perimetric gasket. Butt joint top horizontal. Marked with 2x white.	
4010238	200 m 200 m	WICSTYLE 65	Dichtung Verglasungsdichtung innen. Spalt 8 mm. Dichtung umlaufend. Stoß oben horizontal. Kennzeichen 2 x weiß.	
		EPDM	Gasket Inner glazing gasket. Gap 8 mm.	
		grau grey	Perimetric gasket. Top horizontal joint. Marked with 2 x white.	
4010067	33 m 33 m	WICSTYLE 65evo WICSTYLE 75evo	Klebeband 19 x 1.1 mm Zum Aufkleben von Sprossen auf Glas. Selbstklebend auf gereinigten Glasflächen. WICSTYLE 65/75: Zum Abdichten und Fixieren des Dichtungsaufnahmeprofiles 4930068.	
			Adhesive tape 19 x 1.1 mm For gluing glazing bars on glass. Self-adhesive on cleaned glass surfaces.	
		grau grey	WICSTYLE 65/75: For sealing and fixing with gasket retainer profile 4930068.	
		4930068		
4010047	20 m 20 m	WICSTYLE 65evo WICSTYLE 75evo	Kederdichtung Dichtung bei Stoß zweier mit einander verschraubten Blendrahmen. Dichtungsenden mit dauerelastischer Dichtungsmasse abdichten.	
		EPDM	Profile joint gasket Gasket for joints between two frames screwed together. Seal gasket ends with sealing compound.	
		schwarz black		

WICSTYLE 75 evo / 65 evo / 65

Zubehör
Accessories

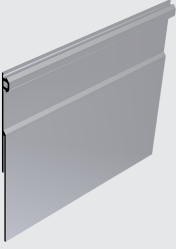

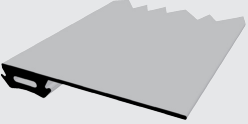
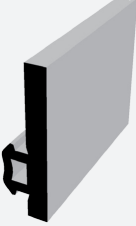
Dichtungen Meterware
Gaskets metre ware

Artikel Article	VE PU	Anwendung Application	Bezeichnung / Hinweise Designation / Indications	Abbildung Figure
		Material / Material Farbe / Colour	Zuordnung Assignment	
4010066	50 m 50 m	WICSTYLE 65evo WICSTYLE 75evo	Dichtbahn Verwendung: Wandanschlussfolie, Dichtbahn 430 mm breit. Dichtbahnen mit EPDM-Klebstoff auf Überlappungen und Untergrund kleben.	
		EPDM	Sealing web Application: Wall junction foil, sealing web width 430 mm. Glue sealing webs with EPDM adhesive on overlappings and underground.	
		schwarz black		
4010090	50 m 50 m	WICSTYLE 65evo WICSTYLE 75evo	Verglasungsdichtung für Durchschusshemmung. Spalt 4 mm	
		EPDM	Glazing gasket for bullet resistance. Gap 4 mm	
		schwarz black		
4010369	50 m 50 m	WICSTYLE 65evo WICSTYLE 75evo	Nutabdeckprofil Verwendung: universell Passend in die EUROWIC Blendrahmenzone.	
		EPDM	Groove cover profile Application: universal	
		schwarz black	Suitable in the EUROWIC frame zone.	
4910026	50 m 50 m	WICSTYLE 65	Ausgleichsdichtung Oberfläche: polymerisiert Verwendung: Adapterdichtung in Verbindung mit Einspannblendrahmen. Dicke 2 mm. In der Ecke auf Gehrung schneiden und verkleben.	
		EPDM	Compensating gasket Surface: polymerized.	
		schwarz black	Application: Adapter gasket in connection with clamping frame. Thickness 2 mm. Mitre cut corners and glued.	

WICSTYLE 75 evo / 65 evo / 65

Zubehör
Accessories

Dichtungen Meterware
Gaskets metre ware

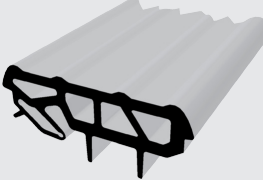
Artikel Article	VE PU	Anwendung Application	Bezeichnung / Hinweise Designation / Indications	Abbildung Figure
		Material / Material Farbe / Colour	Zuordnung Assignment	
4910027	50 m 50 m	WICSTYLE 65	Ausgleichsdichtung Oberfläche: polymerisiert Verwendung: Adapterdichtung in Verbindung mit Einspannblendrahmen. Dicke 4 mm. In der Ecke auf Gehrung schneiden und verkleben.	
		EPDM	Compensating gasket Surface: polymerized.	
		schwarz black	Application: Adapter gasket in connection with clamping frame. Thickness 4 mm. Mitre cut corners and glued.	
4910028	50 m 50 m	WICSTYLE 65	Ausgleichsdichtung Oberfläche: polymerisiert. Verwendung: Adapterdichtung in Verbindung mit Einspannblendrahmen. Dicke 6 mm. In der Ecke auf Gehrung schneiden und verkleben.	
		EPDM	Compensating gasket Surface: polymerized.	
		schwarz black	Application: Adapter gasket in connection with clamping frame. Thickness 6 mm. Mitre cut corners and glued.	
4910042	20 m 20 m	WICSTYLE 65 WICSTYLE 65evo	Flügelgleitdichtung Ein- und auswärts. Mit Flügel dichtungsformecken 4920021, 4920022 bzw. für Standflügel mit Sockel 4920024 (DIN rechts), 4920025 (DIN links) oder mit uml. Flügel 4920026 (DIN rechts), 4920027 (DIN links) verkleben.	
		EPDM	Centre gasket for threshold area In- and outward opening. Glue with moulded gasket angles 4920021, 4920022 . inactive leaf with bottom rail profile 4920024 (DIN right), bottom rail profile 4920025 (DIN left) or circumferential leaf 4920026 (DIN right), 4920027 (DIN left)	
		schwarz black	1020509,1926510,1926511,1926512,1926513 1926514,1926515,1926535,1926536	

WICSTYLE 75 evo / 65 evo / 65

Zubehör
Accessories



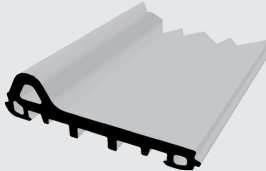
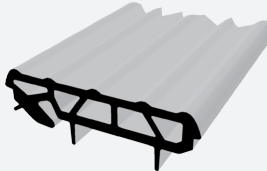
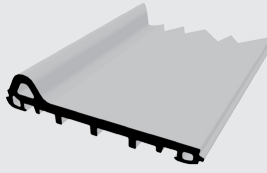
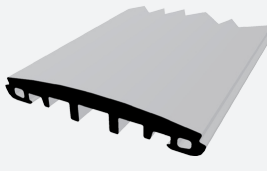
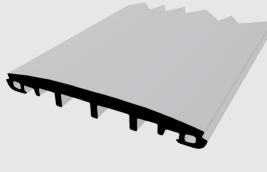

Dichtungen Meterware
Gaskets metre ware

Artikel Article	VE PU	Anwendung Application	Bezeichnung / Hinweise Designation / Indications	Abbildung Figure
		Material / Material Farbe / Colour	Zuordnung Assignment	
4910043	20 m 20 m	WICSTYLE 65evo	Schwelldichtung Mit Schwellenverbinder garnitur 4940155 oder 4940158 verkleben.	
		EPDM	Threshold gasket Glue with threshold connector set 4940155 or 4940158	
		schwarz black	1020457,1926524,1926525,1926526	
4910044	20 m 20 m	WICSTYLE 75evo	Flügel schleifdichtung Für ein- und auswärts. Mit Flügel dichtungsformecken 4920034, 4920035 bzw. für Standflügel mit Sockel 4920037 (DIN rechts), 4920038 (DIN links) oder mit uml. Flügel 4920039 (DIN rechts), 4920040 (DIN links) verkleben.	
		EPDM	Leaf slide gasket For in- and outward opening. Glue with 4920034, 4920035 respectively for inactive leaf with bottom rail profile with 4920037 (DIN right), 4920038 (DIN left) or for circumferential leaf with 4920039 (DIN right), 4920040 (DIN left).	
		schwarz black	1927510,1927511,1927512,1927513,1927514 1927515,1927530	
4910045	20 m 20 m	WICSTYLE 75evo	Schwelldichtung Mit Schwellenverbinder garnitur 4940161 verkleben.	
		EPDM	Threshold gasket Glue with threshold connector set 4940161.	
		schwarz black	1020496,1927524,1927525,1927526	
4910052	20 m 20 m	WICSTYLE 65evo	Schwelldichtung Mit Schwellenverbinder garnitur 4940155 verkleben.	
		EPDM	Threshold gasket Glue with threshold connector set 4940155.	
		schwarz black	1020457,1926525	
4910053	20 m 20 m	WICSTYLE 75evo	Schwelldichtung Mit Schwellenverbinder garnitur 4940161 verkleben.	
		EPDM	Threshold gasket Glue with threshold connector set 4940161.	
		schwarz black	1020496,1927525	

WICSTYLE 75 evo / 65 evo / 65

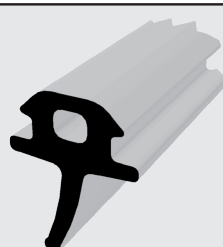
Zubehör
Accessories

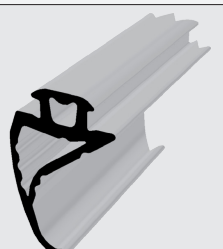

Dichtungen Meterware
Gaskets metre ware

Artikel Article	VE PU	Anwendung Application	Bezeichnung / Hinweise Designation / Indications	Abbildung Figure
		Material / Material Farbe / Colour	Zuordnung Assignment	
4910055	20 m 20 m	WICSTYLE 65evo WICSTYLE 75evo	Schleifdichtung Für flache Schwelle.	
		EPDM	Slide gasket For flat threshold.	
		schwarz black	4930068	
4910056	20 m 20 m	WICSTYLE 65evo WICSTYLE 75evo	Schleifdichtung Für flache Schwelle.	
		EPDM	Slide gasket For flat threshold.	
		schwarz black	4930068	
4910041	50 m 50 m	WICSTYLE 65 WICSTYLE 65evo WICSTYLE 75evo	Anschlagdichtung Verkleben mit Formecken 4920028 bzw. 4920029	
		EPDM	Stop gasket Glue with moulded gasket angles 4920028 respectively 4920029.	
		schwarz black		
4910040	100 m 100 m	WICSTYLE 65 WICSTYLE 65evo WICSTYLE 75evo	Dichtrundschnur D=4.5 mm Universell einsetzbar. Zum Abdichten von Aufsatzprofilen.	
		EPDM	Sealing cord D=4.5 mm Universal application. For sealing supplementary profiles.	
		schwarz black		
4010117	100 m 100 m	WICSTYLE 65evo WICSTYLE 75evo	Schlauchdichtung D=4 mm. Zum Abdichten von Aufsatzprofilen.	
		Silikon Silicone	Tubular gasket D=4 mm. For sealing supplementary profiles.	
		weiß white		

WICSTYLE 75 evo / 65 evo / 65

Zubehör
Accessories

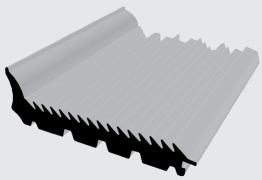
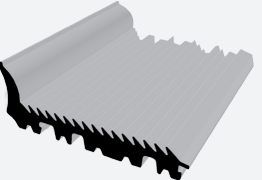
Dichtungen Meterware
Gaskets metre ware

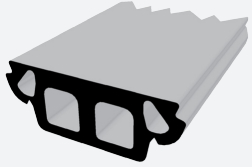
Artikel Article	VE PU	Anwendung Application	Bezeichnung / Hinweise Designation / Indications	Abbildung Figure
		Material / Material Farbe / Colour	Zuordnung Assignment	
4910074	20 m 20 m	WICSTYLE 65evo	Füllungsicherung Verwendung: Rahmenprofile, Kämpfer, Türen, einbruchhemmend, Zuschnitt 100 mm.	
		EPDM	Infill safeguard Application:	
		schwarz black	frame profiles, transoms, door profiles burglar resistant, cut to length 100 mm.	
4910076	20 m 20 m	WICSTYLE 75evo	Füllungsicherung Verwendung: Rahmenprofile, Kämpfer, Türen, einbruchhemmend, Zuschnitt 100 mm.	
		EPDM	Infill safeguard Application:	
		schwarz black	frame profiles, transoms, door profiles, burglar resistance, cut to length 100mm.	
4910082	200 m 200 m	WICSTYLE 65	Verglasungsdichtung innen, 4 mm, grau Verglasungsdichtung innen 4 mm.	
		EPDM	Grey inside gasket 4 mm Inner glazing gasket 4 mm.	
		grau grey		
4910086	20 m 20 m	WICSTYLE 65	Schwelldichtung	
		EPDM	Threshold gasket	
		schwarz black	1926547	

WICSTYLE 75 evo / 65 evo / 65

Zubehör
Accessories

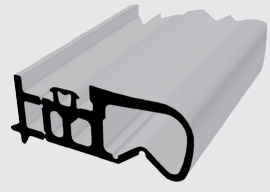
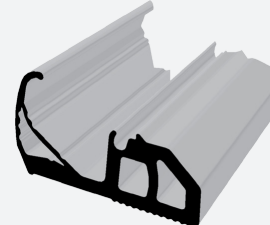
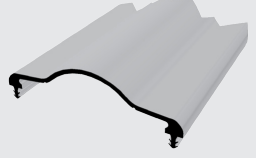

Dichtungen Meterware
Gaskets metre ware

Artikel Article	VE PU	Anwendung Application	Bezeichnung / Hinweise Designation / Indications	Abbildung Figure
		Material / Material Farbe / Colour	Zuordnung Assignment	
4910089	20 m 20 m	WICSTYLE 65evo WICSTYLE 75evo	Fingerschutzdichtung	
		EPDM	Finger protection gasket	
		schwarz black		
4910091	100 m 100 m	WICSTYLE 65evo WICSTYLE 75evo	Anschlagdichtung Für fÜgelüberdeckende FÜllung.	
		EPDM	Stop gasket For leaf overlapping infill.	
		schwarz black		
4910094	3 m 3 m	WICSTYLE 65	Fingerschutzdichtung, Schloßseite	
		TPE	Finger protection gasket, Lock side	
		schwarz black		

WICSTYLE 75 evo / 65 evo / 65

Zubehör
Accessories

Dichtungen Meterware
Gaskets metre ware

Artikel Article	VE PU	Anwendung Application	Bezeichnung / Hinweise Designation / Indications	Abbildung Figure
		Material / Material Farbe / Colour	Zuordnung Assignment	
4010131	250 m 250 m	WICSTYLE 65evo	Bürstendichtung Ein- und zweiflügelige Türen, Gesamthöhe 9,0 mm	
		PP	Weather strip with brush Single and double leaf doors, total height 9,0 mm	
4010132	300 m 300 m	WICSTYLE 65evo	Bürstendichtung Ein- und zweiflügelige Türen, Gesamthöhe 10,75 mm	
		PP	Weather strip with brush Single and double leaf doors, total height 10,75 mm	
			3925099	
4010556	2,5 m 2,5 m	WICSTYLE 65 WICSTYLE 65evo	Bürstendichtung 3 x 9.5 mm	
			Brush seal 3 x 9.5 mm	
		schwarz <i>black</i>		
4910096	2,5 m 2,5 m	WICSTYLE 65 WICSTYLE 65evo	Bürstendichtung 3 x 13.5 mm	
			Brush seal 3 x 13.5 mm	
		schwarz <i>black</i>		
4910097	100 m 100 m	WICSTYLE 65 WICSTYLE 65evo	Bürstendichtung 4.8 x 7 mm	
		PP	Brush seal 4.8 x 7 mm	
		schwarz <i>black</i>		
4910095	100 m 100 m	WICSTYLE 65 WICSTYLE 65evo	Bürstendichtung 4.8 x 8 mm	
			Brush seal 4.8 x 8 mm	

WICSTYLE 75 evo / 65 evo / 65

Zubehör
Accessories

Dichtungen Meterware
Gaskets metre ware

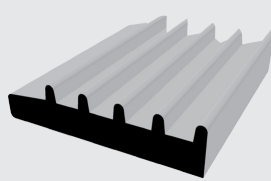
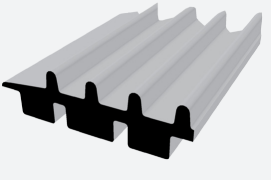
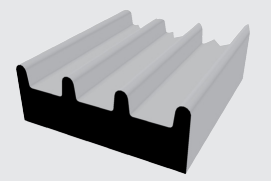
Artikel Article	VE PU	Anwendung Application	Bezeichnung / Hinweise Designation / Indications	Abbildung Figure
		Material / Material Farbe / Colour	Zuordnung Assignment	
4990002	100 m 100 m	WICSTYLE 75evo	Spezial-Dämmprofil Verwendung: Fensterflügelprofile der Bautiefe 65 mm. Türflügelprofile der Bautiefe 75 mm. Umlaufend mit Unterbrechungen an Glasklötzen, Ecken und Entwässerung. Ausnehmungen für die Glasfalzbelüftung vornehmen!	
		PE, geschäumt PE, foamed	Special insulation profile Application:	
		grau grey	In window sash profiles with construction depth 65 mm. In door leaf profiles with construction depth 75 mm. Perimetric with cut-outs in area of glazing shims, corners and drainage areas. Make cut-outs for rebate ventilation!	
4990003	100 m 100 m	WICSTYLE 65evo WICSTYLE 75evo	Spezial-Dämmprofil Verwendung in Blendrahmen- und Kämpferprofilen. Bautiefe 65, 75 und 95 mm. Umlaufend mit Unterbrechungen an Glasklötzen, Ecken und Entwässerung. Ausnehmungen für die Glasfalzbelüftung vornehmen!	
		PE, geschäumt PE, foamed	Special insulation profile Application in frame and transom profiles.	
		grau grey	Construction depth: 65, 75 and 95 mm. Circumferential with cut-outs in area of glazing shims, corners and drainage areas. Make cut-outs for rebate ventilation!	
4990009	100 m 100 m	WICSTYLE 65evo	Spezial-Dämmprofil Verwendung: Umlaufend mit Unterbrechungen an Glasklötzen, Ecken und Entwässerung.	
		PE, geschäumt PE, foamed	Special insulation profile Application: all around with cut-outs in area of	
		grau grey	glazing shims, corners and drainage areas.	

WICSTYLE 75 evo / 65 evo / 65

Zubehör
Accessories

Dichtungen Stückware
Gaskets single parts

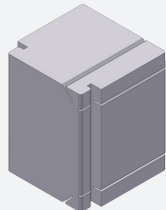
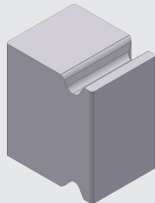
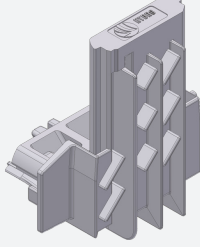
Artikel Article	VE PU	Anwendung Application	Bezeichnung / Hinweise Designation / Indications	Abbildung Figure
		Material / Material Farbe / Colour	Zuordnung Assignment	
4020006	100 St. 100 pcs	WICSTYLE 65 WICSTYLE 65evo WICSTYLE 75evo	Federstück Bei pulverbeschichteten Glasleistenprofilen. Federstücke 15 mm lang. Als Montagehilfe jeweils an den Enden der Glasleisten und mittig einlegen. Anwendung ab 15 mm Glasleistenbreite.	
		EPDM	Spring piece <i>For powder coated glazing beads. Length of spring piece 15 mm. Insert spring pieces at the respective ends of glazing beads and in the centre as assembly help. Application above 15 mm glazing bead width.</i>	
		schwarz black		
4020621	15 St. 15 pcs	WICSTYLE 75evo	Dichtteil für Fingerschutztür (bandseitig) am Flügel oben und unten, am Rahmen nur oben	
		EPDM, geschäumt EPDM, foamed	Sealing part <i>for finger protection door (hinge sided) for leaf at top and bottom, for frame only at top</i>	
		schwarz black		
4020622	5 St. 5 pcs	WICSTYLE 75evo	Dichtteil für Fingerschutztür (bandseitig) Schwellenabdichtung unten im Blendrahmen	
		EPDM, geschäumt EPDM, foamed	Sealing part <i>for finger protection door (hinge sided) sealing part for threshold at the frame</i>	
		schwarz black		
4920021	1 St. 1 pcs	WICSTYLE 65evo	Flügeldichtungsformecke Für Standflügel DIN links. Mit Schleifdichtung 4910042 verkleben.	
		EPDM	Moulded gasket angle <i>For inactive leaf DIN left. Glue with slide gasket 4910042</i>	
		schwarz black		

WICSTYLE 75 evo / 65 evo / 65

Zubehör
Accessories

Dichtungen Stückware
Gaskets single parts

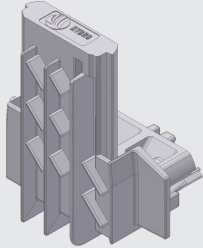
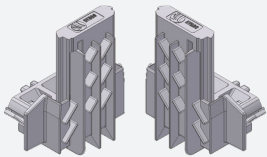
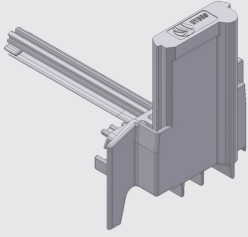
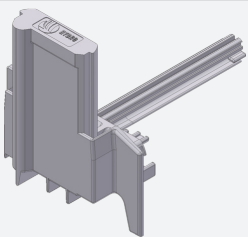
Artikel Article	VE PU	Anwendung Application	Bezeichnung / Hinweise Designation / Indications	Abbildung Figure
		Material / Material Farbe / Colour	Zuordnung Assignment	
4920022	1 St. 1 pcs	WICSTYLE 65evo	Flügeldichtungsformecke Für Standflügel DIN rechts. Mit Schleifdichtung 4910042 verkleben.	
		EPDM	Moulded gasket angle For inactive leaf DIN right.	
		schwarz black	Glue with slide gasket 4910042.	
4920023	1 Garn. 1 set	WICSTYLE 65evo	Flügeldichtungsformecke Garnitur für Gehflügel Mit Schleifdichtung 4910042 verkleben. Bestehend aus: 4920021 und 4920022	
		EPDM	Moulded gasket angle set for the active door leaf Glue with slide gasket 4910042.	
		schwarz black	Consists of: 4920021 and 4920022	
4920024	20 St. 20 pcs	WICSTYLE 65evo	Flügeldichtungsformecke rechts Für Standflügel DIN links, nicht für uml. Flügelprofil mit Stulpaufsatzprofil. Mit 4910042 verkleben.	
		EPDM	Moulded gasket angle right For inactive leaf DIN left, not for circumferential leaf with double casement suppl. profile.	
		schwarz black	Glue with 4910042. 1926516,1926517,1926518	
4920025	20 St. 20 pcs	WICSTYLE 65evo	Flügeldichtungsformecke links Für Standflügel DIN rechts, nicht für uml. Flügelprofil mit Stulpaufsatzprofil. Verkleben mit Schleifdichtung 4910042.	
		EPDM	Moulded gasket angle left For inactive leaf DIN right, not for circumferential leaf with double casement suppl. profile.	
		schwarz black	Glue with slide gasket 4910042. 1926516,1926517,1926518	

WICSTYLE 75 evo / 65 evo / 65

Zubehör
Accessories

Dichtungen Stückware
Gaskets single parts

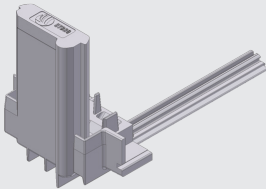
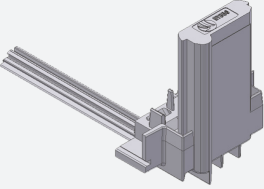
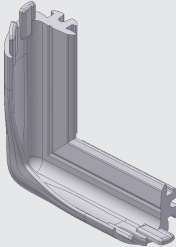
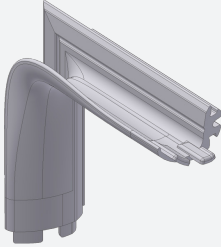
Artikel Article	VE PU	Anwendung Application	Bezeichnung / Hinweise Designation / Indications	Abbildung Figure
		Material / Material Farbe / Colour	Zuordnung Assignment	
4920026	20 St. 20 pcs	WICSTYLE 65evo	Flügeldichtungsformecke rechts Für Standflügel DIN links, mit uml. Flügelprofil und Stulpaufsatzprofil. Verkleben mit Schleifdichtung 4910042.	
		EPDM	Moulded gasket angle right <i>For inactive leaf DIN left, with circumferential leaf and double casement supplem. profile. Glued with slide gasket 4910042.</i>	
		schwarz black	1020509,1926510,1926511,1926512,1926513 1926514,1926515	
4920027	20 St. 20 pcs	WICSTYLE 65evo	Flügeldichtungsformecke links Für Standflügel DIN rechts, mit uml. Flügelprofil und Stulpaufsatzprofil. Mit Schleifdichtung 4910042 verkleben.	
		EPDM	Moulded gasket angle left <i>For inactive leaf DIN right, with circumferential leaf and double casement supplem. profile. Glued with slide gasket 4910042.</i>	
		schwarz black	1020509,1926510,1926511,1926512,1926513 1926514,1926515	
4920028	50 St. 50 pcs	WICSTYLE 65 WICSTYLE 65evo WICSTYLE 75evo	Dichtungsecke Für Flügelprofile. Mit Anschlagdichtung 4910041 verkleben.	
		EPDM	Gasket angle <i>For leaf profile. Glue with stop gasket 4910041.</i>	
		schwarz black		
4920029	50 St. 50 pcs	WICSTYLE 65 WICSTYLE 65evo WICSTYLE 75evo	Dichtungsecke Für Blendrahmenprofile. Mit Anschlagdichtung 4910041 verkleben.	
		EPDM	Gasket angle <i>For frame profile. Glue with stop gasket 4910041.</i>	
		schwarz black		

WICSTYLE 75 evo / 65 evo / 65

Zubehör
Accessories

Dichtungen Stückware
Gaskets single parts

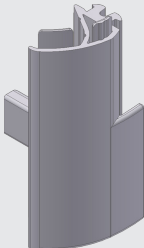
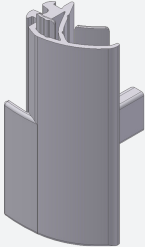
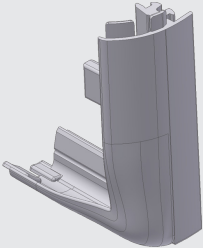
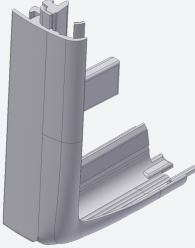
Artikel Article	VE PU	Anwendung Application	Bezeichnung / Hinweise Designation / Indications	Abbildung Figure
		Material / Material Farbe / Colour	Zuordnung Assignment	
4920030	50 St. 50 pcs	WICSTYLE 65evo WICSTYLE 75evo	Dichtungsendstück Für Aufsatzprofile ohne horizontale Dichtung, im Standflügel rechts. Mit Anschlagdichtung 4910041 verkleben.	
		EPDM	Gasket end piece <i>For supplementary profile without horiz. gasket, on the inactiv leaf right.</i> <i>Glued with stop gasket 4910041.</i>	
		schwarz black	1926530,3925094	
4920031	50 St. 50 pcs	WICSTYLE 65evo WICSTYLE 75evo	Dichtungsendstück Für Aufsatzprofile ohne horizontale Dichtung, im Standflügel links. Mit Anschlagdichtung 4910041 verkleben.	
		EPDM	Gasket end piece <i>For supplementary profile without horiz. gasket, on the inactiv leaf left.</i> <i>Glued with stop gasket 4910041.</i>	
		schwarz black	1926530,3925094	
4920032	50 St. 50 pcs	WICSTYLE 65evo WICSTYLE 75evo	Dichtecke Für Aufsatzprofile mit horizontaler Dichtung, im Gehflügel links. Mit Anschlagdichtung 4910041 verkleben.	
		EPDM	Gasket angle <i>For supplementary profile with horiz. gasket in the active leaf left.</i> <i>Glued with stop gasket 4910041.</i>	
		schwarz black	3925094	
4920033	50 St. 50 pcs	WICSTYLE 65evo WICSTYLE 75evo	Dichtungsecke rechts Für Aufsatzprofile mit horizontaler Dichtung, im Gehflügel rechts. Mit Anschlagdichtung 4910041 verkleben.	
		EPDM	Gasket angle right <i>For supplementary profile with horiz. gasket in the active leaf right.</i> <i>Glued with stop gasket 4910041.</i>	
		schwarz black	3925094	

WICSTYLE 75 evo / 65 evo / 65

Zubehör
Accessories

Dichtungen Stückware
Gaskets single parts

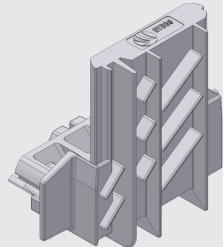
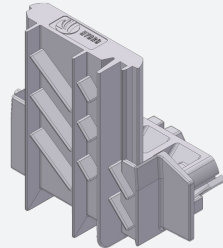
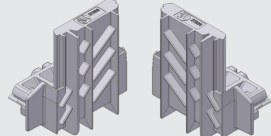
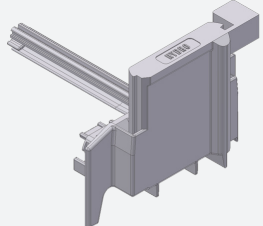
Artikel Article	VE PU	Anwendung Application	Bezeichnung / Hinweise Designation / Indications	Abbildung Figure
		Material / Material Farbe / Colour	Zuordnung Assignment	
4920034	1 St. 1 pcs	WICSTYLE 75evo	Flügeldichtungsformecke Für Standflügel DIN links. Mit Schleifdichtung 4910044 verkleben.	
		EPDM	Moulded gasket angle for door leaf For inactive leaf DIN left.	
		schwarz black	Glue with slide gasket 4910044.	
4920035	1 St. 1 pcs	WICSTYLE 75evo	Flügeldichtungsformecke Für Standflügel DIN rechts. Mit Schleifdichtung 4910044 verkleben.	
		EPDM	Moulded gasket angle for door leaf For inactive leaf DIN right.	
		schwarz black	Glue with slide gasket 4910044.	
4920036	1 Garn. 1 set	WICSTYLE 75evo	Flügeldichtungsformecke Garnitur Für den Gehflügel. Mit Schleifdichtung 4910044 verkleben. Bestehend aus: 4920034 und 4920035	
		EPDM	Moulded gasket angle set For the active leaf.	
		schwarz black	Glue with slide gasket 4910044. Consists of: 4920034 and 4920035	
4920037	1 St. 1 pcs	WICSTYLE 75evo	Flügeldichtungsformecke rechts Für Standflügel DIN links, nicht für uml. Flügelprofil mit Stulpaufsatzprofil. Mit Schleifdichtung 4910044 verkleben.	
		EPDM	Moulded gasket angle right For inactive leaf DIN left, not for circumferential	
		schwarz black	leaf with double casement suppl. Profile. Glue with slide gasket 4910044.	

WICSTYLE 75 evo / 65 evo / 65

Zubehör
Accessories

Dichtungen Stückware
Gaskets single parts

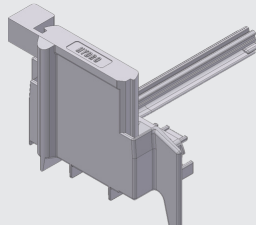
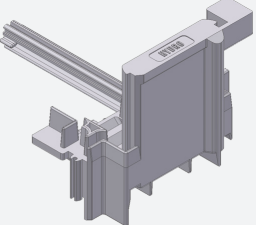
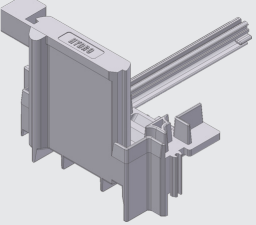
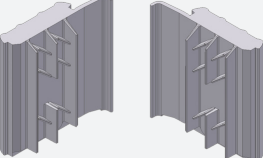
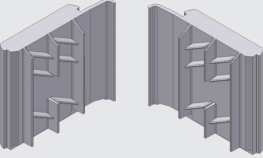
Artikel Article	VE PU	Anwendung Application	Bezeichnung / Hinweise Designation / Indications	Abbildung Figure
		Material / Material Farbe / Colour	Zuordnung Assignment	
4920038	1 St. 1 pcs	WICSTYLE 75evo	Flügeldichtungsformecke links Für Standflügel DIN rechts, nicht für uml. Flügelprofil mit Stulpaufsatzprofil. Mit Schleifdichtung 4910044 verkleben.	
		EPDM	Moulded gasket angle left <i>For inactive leaf DIN right, not for circumferential leaf with double casement supplem. Profile. Glue with slide gasket 4910044.</i>	
		schwarz black		
4920039	1 St. 1 pcs	WICSTYLE 75evo	Flügeldichtungsformecke rechts Für Standflügel DIN links mit uml. Flügelprofil und Stulpaufsatzprofil. Verkleben mit Schleifdichtung 4910044.	
		EPDM	Moulded gasket angle right <i>For inactive leaf DIN left, with circumferential leaf and double casement supplem. Profile. Glue with slide gasket 4910044.</i>	
		schwarz black		
4920040	1 St. 1 pcs	WICSTYLE 75evo	Flügeldichtungsformecke links Für Standflügel DIN rechts mit uml. Flügelprofil und Stulpaufsatzprofil. Verkleben mit Schleifdichtung 4910044.	
		EPDM	Moulded gasket angle left <i>For inactive leaf DIN right, with circumferential leaf and double casement supplem. Profile. Glue with slide gasket 4910044.</i>	
		schwarz black		
4920044	1 Garn. 1 set	WICSTYLE 65 WICSTYLE 65evo	Rahmendichtungsformteil Für flache Schwelle.	
		EPDM	Moulded gasket part for frame <i>For flat threshold.</i>	
		schwarz black	3021033,3926501	
4920047	1 Garn. 1 set	WICSTYLE 75evo	Rahmendichtungsformteil Für flache Schwelle.	
		EPDM	Moulded gasket part for frame <i>For flat threshold.</i>	
		schwarz black		

WICSTYLE 75 evo / 65 evo / 65

Zubehör
Accessories

Dichtungen Stückware
Gaskets single parts

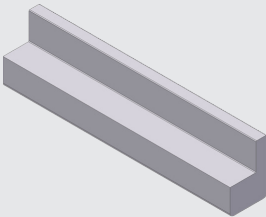
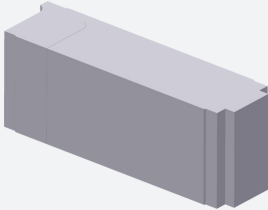
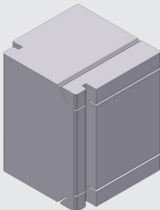
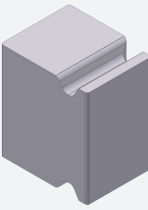
Artikel Article	VE PU	Anwendung Application	Bezeichnung / Hinweise Designation / Indications	Abbildung Figure
		Material / Material Farbe / Colour	Zuordnung Assignment	
4920060	50 St. 50 pcs	WICSTYLE 65 WICSTYLE 65evo WICSTYLE 75evo	Dichtteil Dichtteil zur Abdichtung der Nut zwischen Schwellenverbinder und Spezialblendrahmen.	
		EPDM, geschäumt EPDM, foamed	Sealing part For sealing the groove between threshold connector and special frame profile.	
		schwarz black	1926500,1926501,1926502,1926503,1926504 1927500,1927501,1927502	
4920100	50 St. 50 pcs	WICSTYLE 65evo WICSTYLE 75evo	Dichtungsteil Für Sockelanwendung. Von unten in die Hohlkammer des vertikalen Profils einschieben. Für kleine Ansichtsbreite ggf. Teil an der Sollbruchstelle kürzen.	
		EPDM, geschäumt EPDM, foamed	Sealing part For bottom rail profile application. Slide in from the bottom into the vertical profile. Shorten at the predetermined breaking point for the smaller viewing width.	
		schwarz black	1926510,1926511,1926513,1926514,1927510 1927511,1927513,1927514	
4920101	15 St. 15 pcs	WICSTYLE 65evo	Dichtteil für Fingerschutztür (bandseitig) am Flügel oben und unten, am Rahmen nur oben	
		EPDM, geschäumt EPDM, foamed	Sealing part for finger protection door (hinge sided) for leaf at top and bottom, for frame only at top	
		schwarz black		
4920102	5 St. 5 pcs	WICSTYLE 65evo	Dichtteil für Fingerschutztür (bandseitig) Schwellenabdichtung unten im Blendrahmen	
		EPDM, geschäumt EPDM, foamed	Sealing part for finger protection door (hinge sided) sealing part for threshold at the frame	
		schwarz black		

WICSTYLE 75 evo / 65 evo / 65

Zubehör
Accessories

Dichtungen Stückware
Gaskets single parts

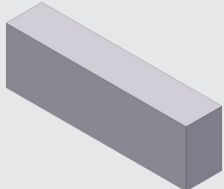
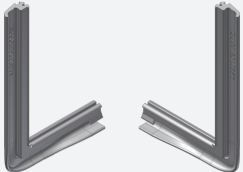
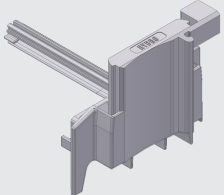
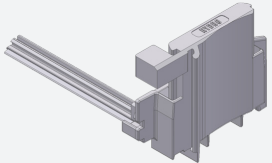
Artikel Article	VE PU	Anwendung Application	Bezeichnung / Hinweise Designation / Indications	Abbildung Figure
		Material / Material Farbe / Colour	Zuordnung Assignment	
4920103	5 St. 5 pcs	WICSTYLE 65evo WICSTYLE 75evo	Endstück für Fingerschutztür (bandseitig)	
		EPDM, geschäumt EPDM, foamed	End part for finger protection door (hinge sided)	
		schwarz black		
4920110	10 Garn. 10 set	WICSTYLE 65	Dichtungsformecke, Garnitur	
		EPDM	Moulded gasket angle, set	
		schwarz black		
4920117	1 St. 1 pcs	WICSTYLE 75evo	Flügeldichtungsformecke rechts Fluchttürsysteme Für Standflügel DIN links, nicht für uml. Flügelprofil mit Stulpaufsatzprofil. Mit Schleifdichtung 4910044 verkleben.	
		EPDM	Moulded gasket angle right escape door systems For inactive leaf DIN left, not for circumferential leaf with double casement supplm. Profile.	
		schwarz black		
4920118	1 St. 1 pcs	WICSTYLE 75evo	Flügeldichtungsformecke links Fluchttürsysteme Für Standflügel DIN rechts, nicht für uml. Flügelprofil mit Stulpaufsatzprofil. Mit Schleifdichtung 4910044 verkleben.	
		EPDM	Moulded gasket angle left Escape door systems For inactive leaf DIN right, not for circumferential leaf with double casement supplm. Profile. Glue with Gasket 4910044.	
		schwarz black		

WICSTYLE 75 evo / 65 evo / 65

Zubehör
Accessories

Dichtungen Stückware
Gaskets single parts

Artikel Article	VE PU	Anwendung Application	Bezeichnung / Hinweise Designation / Indications	Abbildung Figure
		Material / Material Farbe / Colour	Zuordnung Assignment	
4920119	1 St. 1 pcs	WICSTYLE 75evo	Flügeldichtungsformecke rechts Fluchttürsysteme Für Standflügel DIN links mit uml. Flügelprofil und Stulpaufsatzprofil. Verkleben mit 4910044.	
		EPDM	Moulded gasket angle right Escape door systems <i>For inactive leaf DIN left, with circumferential leaf and double casement supplm. Profile. Glue with gasket 4910044.</i>	
		schwarz black		
4920120	1 St. 1 pcs	WICSTYLE 75evo	Flügeldichtungsformecke links Fluchttürsysteme Für Standflügel DIN rechts mit uml. Flügelprofil und Stulpaufsatzprofil. Verkleben mit 4910044.	
		EPDM	Moulded gasket angle left Escape door systems <i>For inactive leaf DIN right, with circumferential leaf and double casement supplm. Profile. Glue with gasket 4910044.</i>	
		schwarz black		

WICSTYLE 75 evo / 65 evo / 65

Zubehör
Accessories



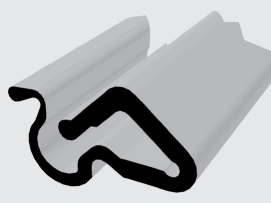
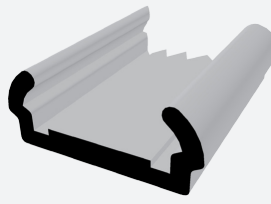
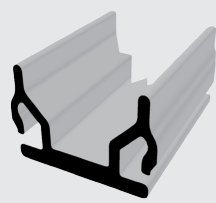
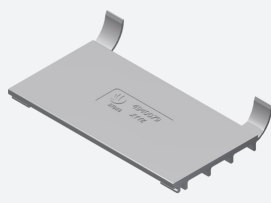

Kunststoffprofile, Formstücke
Plastic profiles, moulded pieces

Artikel Article	VE PU	Anwendung Application	Bezeichnung / Hinweise Designation / Indications	Abbildung Figure
		Material / Material Farbe / Colour	Zuordnung Assignment	
4020049	100 St. 100 pcs	WICSTYLE 65evo WICSTYLE 75evo	Federstück Bei eloxierten Glasleistenprofilen. Federstücke 15 mm lang. Als Montagehilfe ca. 50 mm von den Glasleistenenden und jede weitere Abstände 250 - 300 mm. Anwendung ab 15 mm Glasleistenbreiten.	
		PA	Spring piece For anodized glazing beads.	
		schwarz black	Length of spring piece 15 mm. Insert spring pieces approx. 50 mm from the respective ends of glazing beads as assembly help and every further distances of 250 - 300 mm. Application above 15 mm glazing bead width.	
4030019	3 m 3 m	WICSTYLE 65evo WICSTYLE 75evo	Abdeckprofil Zum Abdecken der Glasleistennut.	
		Kunststoff Plastic	Cover profile To cover the glazing bead retaining groove.	
		schwarz black		
4030031	5 m 5 m	WICSTYLE 65evo	Abdeckprofil	
		ABS	Cover profile	
		schwarz black		
4940079	100 St. 100 pcs	WICSTYLE 75evo	Vorklotz Verwendung: Für alle Fensterrahmenprofile und Türflügelprofile! Gegen Abrutschen sichern!	
		PA	Glazing support Application: For window frame profiles and door leaf profiles.	
		schwarz black	Secure against slipping.	

WICSTYLE 75 evo / 65 evo / 65

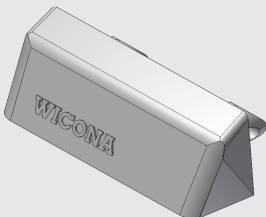
Zubehör
Accessories

Kunststoffprofile, Formstücke
Plastic profiles, moulded pieces

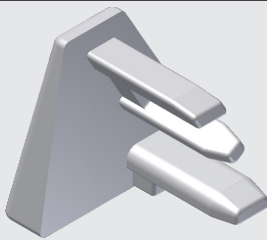
Artikel Article	VE PU	Anwendung Application	Bezeichnung / Hinweise Designation / Indications	Abbildung Figure
		Material / Material Farbe / Colour	Zuordnung Assignment	
4040026	100 St. 100 pcs	WICSTYLE 65evo WICSTYLE 75evo	Entwässerungsabdeckung Zum Dampfdruckausgleich und Entwässerung der Dichtungsvorkammer.	
		PA	Weephole cover For air pressure equalization and drainage of gasket prechamber.	
		schwarz black		
4040027	100 St. 100 pcs	WICSTYLE 65evo WICSTYLE 75evo	Entwässerungsabdeckung Zum Dampfdruckausgleich und Entwässerung der Dichtungsvorkammer.	
		PA	Weephole cover For air pressure equalization and drainage of gasket prechamber.	
		weiß white		
4040028	100 St. 100 pcs	WICSTYLE 65evo WICSTYLE 75evo	Entwässerungsabdeckung Zum Dampfdruckausgleich und Entwässerung der Dichtungsvorkammer.	
		PA	Weephole cover For air pressure equalization and drainage of gasket prechamber.	
		grau grey		
4040610	100 St. 100 pcs	WICSTYLE 65	Entwässerungsabdeckung	
		PA	Weephole cover	
		grau grey weiß white schwarz black		
4040029	50 St. 50 pcs	WICSTYLE 65	Endstück Wetterschenkel links In Profil einkleben. Längenkorrektur gesamt = - 8 mm.	
		ABS	End piece weather bar left Glue into profile. Total length correction = - 8 mm.	
		schwarz black	3925100	

WICSTYLE 75 evo / 65 evo / 65

Zubehör
Accessories





Kunststoffprofile, Formstücke
Plastic profiles, moulded pieces

Artikel Article	VE PU	Anwendung Application	Bezeichnung / Hinweise Designation / Indications	Abbildung Figure
		Material / Material Farbe / Colour	Zuordnung Assignment	
4040030	50 St. 50 pcs	WICSTYLE 65	Endstück Wetterschenkel rechts In Profil einkleben. Längenkorrektur gesamt = - 8 mm.	
		ABS	End piece weather bar, right Glue into profile. Total length correction: - 8 mm.	
		schwarz black	3925100	
4040086	100 St. 100 pcs	WICSTYLE 65evo WICSTYLE 75evo	Abdeckkappe Bohrung Ø12 mm.	
		ABS	Cover cap Borehole Ø12 mm.	
		schwarz black		
4040088	100 St. 100 pcs	WICSTYLE 65evo WICSTYLE 75evo	Abdeckkappe Bohrung Ø10 mm.	
		PE	Cover cap Borehole Ø10 mm.	
		schwarz black		
4070030	100 St. 100 pcs	WICSTYLE 65 WICSTYLE 65evo WICSTYLE 75evo	Leitteil für Injektion In Stoßverbinder stecken für Klebereinspritzung	
		PA	Injection guide part Insert in butt connector for glue injection	
4930048	6,5 m 6,5 m	WICSTYLE 65evo	Abdeckprofil Für Beschlagsnut.	
		ABS	Cover profile For fitting groove.	
		schwarz black		
4930049	6,5 m 6,5 m	WICSTYLE 65evo	Adapterprofil Für 22 mm Stulpbreite.	
		ABS	Adapter profile For 22 mm striker plates.	
		schwarz black	5040407	

WICSTYLE 75 evo / 65 evo / 65

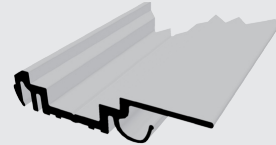
Zubehör
Accessories

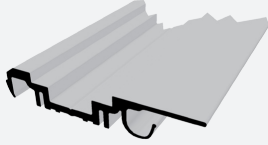

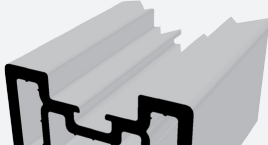
Kunststoffprofile, Formstücke
Plastic profiles, moulded pieces

Artikel Article	VE PU	Anwendung Application	Bezeichnung / Hinweise Designation / Indications	Abbildung Figure
		Material / Material Farbe / Colour	Zuordnung Assignment	
4930050	6,5 m 6,5 m	WICSTYLE 65evo	Adapterprofil Für 24 mm Stulpbreite.	
		ABS	Adapter profile For 24 mm striker plates.	
		schwarz black	5040408	
4930051	6,5 m 6,5 m	WICSTYLE 75evo	Abdeckprofil Für Beschlagsnut.	
		ABS	Cover Profile For fitting groove.	
		schwarz black		
4930052	6,5 m 6,5 m	WICSTYLE 75evo	Adapterprofil Für 22 mm Stulpbreite.	
		ABS	Adapter Profile For 22 mm striker plates.	
		schwarz black	5040407	
4930053	6,5 m 6,5 m	WICSTYLE 75evo	Adapterprofil Für 24 mm Stulpbreite.	
		ABS	Adapter Profile For 24 mm striker plates.	
		schwarz black	5040408	
4930067	6,5 m 6,5 m	WICSTYLE 65evo WICSTYLE 75evo	Fixierprofil für die Fixierung von Unterbauprofilen	
		PA	Fixing profile for the fixation of substructure profiles	
		schwarz black	1926529,1926530,1927529,1927530	
4930068	6,5 m 6,5 m	WICSTYLE 65evo WICSTYLE 75evo	Dichtungsaufnahmeprofil	
		ABS	Gasket retainer profile	
		schwarz black	4010067,4910055,4910056	

WICSTYLE 75 evo / 65 evo / 65

Zubehör
Accessories

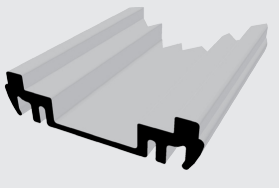
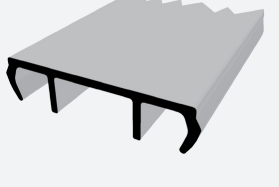
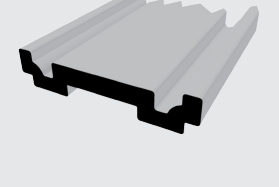

Kunststoffprofile, Formstücke
Plastic profiles, moulded pieces

Artikel Article	VE PU	Anwendung Application	Bezeichnung / Hinweise Designation / Indications	Abbildung Figure
		Material / Material Farbe / Colour	Zuordnung Assignment	
4930076	2,5 m 2,5 m	WICSTYLE 65evo	Abdeckprofil EH	
		ABS	Cover profile burglar resistant	
		schwarz <i>black</i>		
4930077	2,5 m 2,5 m	WICSTYLE 75evo	Abdeckprofil EH	
		ABS	Cover profile burglar resistant	
		schwarz <i>black</i>		
4930084	6,5 m 6,5 m	WICSTYLE 65	Adapterprofil, 24 mm Stulpbreite	
		ABS	Adapter profile, 24 mm	
		schwarz <i>black</i>		
4930085	6,5 m 6,5 m	WICSTYLE 65 WICSTYLE 65evo	Abdeckprofil Für Beschlagnut.	
		ABS	Cover profile For fitting groove.	
		schwarz <i>black</i>		
4930086	6,5 m 6,5 m	WICSTYLE 65	Schieberstange Für 2 und 3 Punkt Schlösser	
		PA	Slide rod For 2 and 3 point locks	
		schwarz <i>black</i>	5940072	

WICSTYLE 75 evo / 65 evo / 65

Zubehör
Accessories

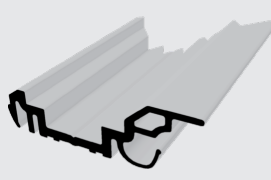
Kunststoffprofile, Formstücke
Plastic profiles, moulded pieces

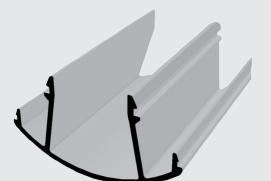
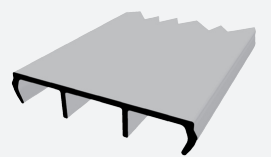
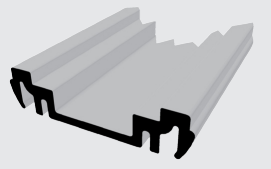
Artikel Article	VE PU	Anwendung Application	Bezeichnung / Hinweise Designation / Indications	Abbildung Figure
		Material / Material Farbe / Colour	Zuordnung Assignment	
4930089	2,5 m 2,5 m	WICSTYLE 65evo	Adapterprofil Für 22 mm Stulpbreite; Einbruchhemmung.	
		ABS	Adapter profile For 22 mm striker plate, burglar resistance.	
		schwarz black	5040407	
4930090	2,5 m 2,5 m	WICSTYLE 75evo	Adapterprofil Für Einbruchhemmung, 22 mm Stulpbreite.	
		ABS	Adapter Profile For burglar resistance, 22 mm clamping cover.	
		schwarz black	5040407	
4930098	6,5 m 6,5 m	WICSTYLE 65 WICSTYLE 65evo	Zusatzprofil Für Pendeltüren. Gegen verrutschen sichern.	
		ASA	Additional profile For double action doors. Secure against sliding	
		schwarz black		
4930099	6,5 m 6,5 m	WICSTYLE 75evo	Abdeckprofil Für Beschlagsnut.	
		ABS	Cover profile For fitting groove.	
		schwarz black		
4930100	6,5 m 6,5 m	WICSTYLE 65evo	Adapter profil Fluchttürsysteme Für 22 mm Stulpbreite.	
		ASA	Adapter profile Escape door systems For 22 mm striker plates.	
		schwarz black	5040407	

WICSTYLE 75 evo / 65 evo / 65

Zubehör
Accessories

Kunststoffprofile, Formstücke
Plastic profiles, moulded pieces

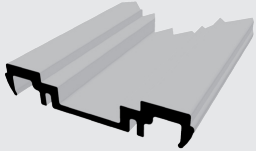
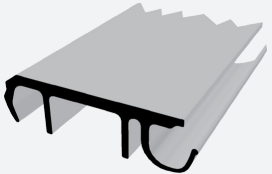
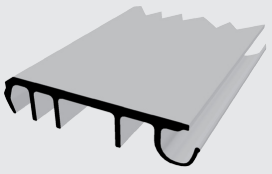
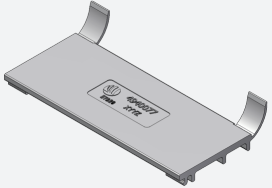
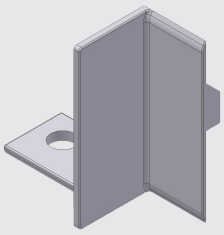
Artikel Article	VE PU	Anwendung Application	Bezeichnung / Hinweise Designation / Indications	Abbildung Figure
		Material / Material Farbe / Colour	Zuordnung Assignment	
4930101	6,5 m 6,5 m	WICSTYLE 75evo	Adapterprofil Fluchttürsysteme Für 22 mm Stulpbreite.	
		ABS	Adapter profile Escape door systems For 22 mm striker plates.	
		schwarz black	5040407	
4930111	6,5 m 6,5 m	WICSTYLE 65evo	Abdeckprofil Für fÜgelüberdeckende FÜllung.	
		ABS	Cover profile For leaf overlapping infill.	
		schwarz black		
4930112	6,5 m 6,5 m	WICSTYLE 75evo	Abdeckprofil Für fÜgelüberdeckende FÜllung.	
		ABS	Cover profile For leaf overlapping infill.	
		schwarz black		
4940077	100 St. 100 pcs	WICSTYLE 65 WICSTYLE 65evo	Vorklotz Verwendung: Für alle Fensterrahmenprofile und TürlÜgelprofile! Gegen Abrutschen sichern!	
		PA	Glazing shim Application: For window frame profiles and door leaf profiles. Secure against slipping.	
		schwarz black	1916203	
4940143	10 St. 10 pcs	WICSTYLE 65 WICSTYLE 65evo WICSTYLE 75evo	Abschlußteil Bei 2-flÜgeligen Anschlagtüren ohne Stulpaufsatzprofil. StandflÜgel DIN links, ein- und auswärts (oben) StandflÜgel DIN rechts, ein- und auswärts (unten) Verbindungsmittel: 1x 4070040	
		PA	End piece For inactive leaf without double casement supplement profile. DIN left, in- and outwards (top side) DIN right, in- and outwards (bottom side) Connection device: 1x 4070040	
		grau grey weiß white schwarz black		

WICSTYLE 75 evo / 65 evo / 65

Zubehör
Accessories

Kunststoffprofile, Formstücke
Plastic profiles, moulded pieces

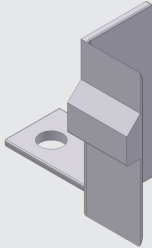
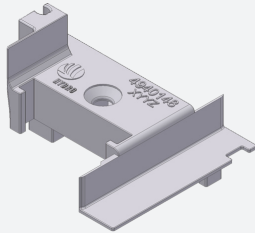
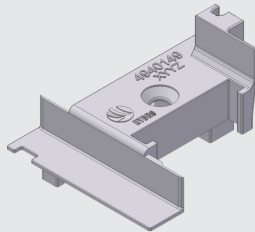
Artikel Article	VE PU	Anwendung Application	Bezeichnung / Hinweise Designation / Indications	Abbildung Figure
		Material / Material Farbe / Colour	Zuordnung Assignment	
4940144	10 St. 10 pcs	WICSTYLE 65 WICSTYLE 65evo WICSTYLE 75evo	Abschlussenteil Bei 2-flügeligen Anschlagtüren ohne Stulpaufsatzprofil. Standflügel DIN rechts, ein- und auswärts (oben) Standflügel DIN links, ein- und auswärts (unten) Verbindungsmittel: 1x 4070040	
		PA	End piece For inactive leaf without double casement supplem. profile DIN right, in- and outwards (top side) DIN left, in- and outwards (bottom side) Connection device: 1x 4070040	
		grau grey weiß white schwarz black		
4940148	1 St. 1 pcs	WICSTYLE 65evo	Abschlussenteil Bei 2-flügeligen Anschlagtüren mit Stulpaufsatzprofil. Standflügel DIN links (ein- und auswärts) Verbindungsmittel: 1x 4970072	
		PA	End part Double leaf hinged doors with double casement supplem. profile DIN left (in- and outwards opening)Connection device: 1x 4970072	
		schwarz black	1926523	
4940149	1 St. 1 pcs	WICSTYLE 65evo	Abschlussenteil Bei 2-flügeligen Anschlagtüren mit Stulpaufsatzprofil. Standflügel DIN rechts (ein- und auswärts) Verbindungsmittel: 1x 4970072	
		PA	End part Double leaf hinged doors with double casement supplem. profile DIN right (in- and outside opening)	
		schwarz black	Connection device: 1x 4970072 1926523	

WICSTYLE 75 evo / 65 evo / 65

Zubehör
Accessories

Kunststoffprofile, Formstücke
Plastic profiles, moulded pieces

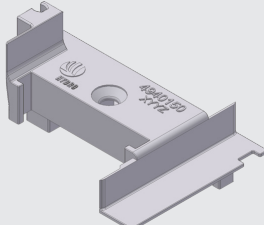
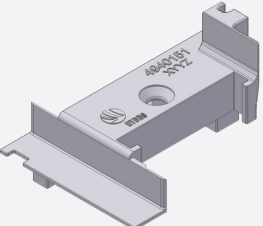
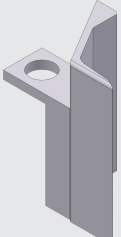
Artikel Article	VE PU	Anwendung Application	Bezeichnung / Hinweise Designation / Indications	Abbildung Figure
		Material / Material Farbe / Colour	Zuordnung Assignment	
4940150	1 St. 1 pcs	WICSTYLE 75evo	Abschlussstück Für 2-flügelige Anschlagtüren mit Stulpaufsatzprofil. Standflügel DIN links (ein- und auswärts) Verbindungsmittel: 1x 4970072	
		PA	End piece For double leaf hinged doors with supplem. profile, inactive leaf DIN left.	
		schwarz black	Connecting device: 1x 4970072 1927523	
4940151	1 St. 1 pcs	WICSTYLE 75evo	Abschlussstück 2-flügelige Anschlagtüren mit Stulpaufsatzprofil. Standflügel DIN rechts (ein- und auswärts) Verbindungsmittel: 1x 4970072	
		PA	End piece For double casement with supplem. profile, inactive leaf DIN right (inwards & outwards).	
		schwarz black	Connecting device: 1x 4970072 1927523	
4940152	10 St. 10 pcs	WICSTYLE 65evo WICSTYLE 75evo	Endstück Bei Gegentaktüren DIN links (einwärts, auswärts) Verbindungsmittel: 1x 4070448	
		PA	End piece For push-pull doors DIN left (inwards, outwards)	
		schwarz black	Connecting device: 1x 4070448 1926521, 1926522, 1927521, 1927522	

WICSTYLE 75 evo / 65 evo / 65

Zubehör
Accessories

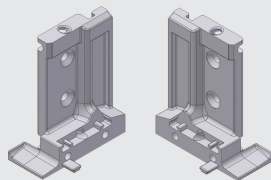
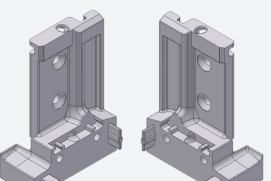
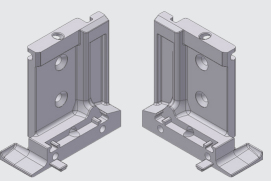

Kunststoffprofile, Formstücke
Plastic profiles, moulded pieces

Artikel Article	VE PU	Anwendung Application	Bezeichnung / Hinweise Designation / Indications	Abbildung Figure
		Material / Material Farbe / Colour	Zuordnung Assignment	
4940155	1 Garn. 1 set	WICSTYLE 65evo	Schwellenverbinder Mit Schwelle abdichten und verschrauben. Verbindungsmittel: 2x 4970072 Bohrschraube 2x 4070048 ST 4,2 x 45	
			Threshold connector Seal and screw with threshold.	
		schwarz black	Connecting device: 2x 4970072 Drilling screw 2x 4070048 ST 4,2 x 45	
			1020457,1926524,1926525,3926500	
4940158	1 Garn. 1 set	WICSTYLE 65evo	Schwellenverbinder Mit Schwelle abdichten und verschrauben. Verbindungsmittel: 2x 4970072 Bohrschraube 2x 4070048 ST 4,2 x 45	
		PA	Threshold connector Seal and screw with threshold.	
		schwarz black	Connecting device: 2x 4970072 Drilling screw 2x 4070048 ST 4,2 x 45	
			1926526	
4940161	1 Garn. 1 set	WICSTYLE 75evo	Schwellenverbinder Garnitur Für Altbau. Bestehend aus: 4940159, 4940160 Mit Schwelle abdichten und verschrauben. Verbindungsmittel: 2x 4970072 Bohrschraube 2x 4070048 ST 4,2 x 45	
		PA	Threshold connector set For renovation.	
		schwarz black	Consists of: 4940159, 4940160 Seal and screw with threshold. Connecting device: 2x 4970072 Drilling screw 2x 4070044 ST 4,2 x 45	
			1020496,1927524,1927525	

WICSTYLE 75 evo / 65 evo / 65

Zubehör
Accessories

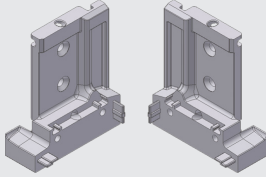
Kunststoffprofile, Formstücke
Plastic profiles, moulded pieces

Artikel Article	VE PU	Anwendung Application	Bezeichnung / Hinweise Designation / Indications	Abbildung Figure
		Material / Material Farbe / Colour	Zuordnung Assignment	
4940164	1 Garn. 1 set	WICSTYLE 75evo	Schwellenverbinder Garnitur Für Neubau. Bestehend aus: 4940162, 4940163 Mit Schwelle abdichten und verschrauben. Verbindungsmittel: 2x 4970072 Bohrschraube 2x 4070048 ST 4,2 x 45	
		PA	Threshold connector set For renovation. Consists of: 4940162, 4940163 Seal and screw with threshold.	
		schwarz black	Connecting device: 2x 4970072 Drilling screw 2x 4070048 ST 4,2 x 45 1927526	
4940170	50 St. 50 pcs	WICSTYLE 65evo	Befestigungsteil Bauanschlussbefestigung: HUS-S 7.5, Dübel Ø8 mm, M16 für Adjufix-Befestigung	
		PA	Fastening part For fixation of junction to structure: HUS-S 7.5, Dowel Ø8 mm, M16 for Adjufix fixation	
		schwarz black	1916001,1916002,1916003,1916004,1916005 1916055,1916056,1916057,1916058,1916059 1916060,1916062,1916064,1916067,1926500 1926501,1926502,1926503,1926532	
4940171	50 St. 50 pcs	WICSTYLE 75evo	Befestigungsteil Bauanschlussbefestigung: HUS-S 7.5 Dübel Ø8 mm, M16 für Adjufix-Befestigung	
		PA	Fastening part For fixation of junction to structure:	
		schwarz black	HUS-S 7.5 Dowel Ø8 mm, M16 for Adjufix fixation 1917001,1917002,1917003,1917004,1917005 1917055,1917056,1917057,1917058,1917059 1917060,1917062,1917064,1917067,1927500 1927501,1927502,1927532	

WICSTYLE 75 evo / 65 evo / 65

Zubehör
Accessories

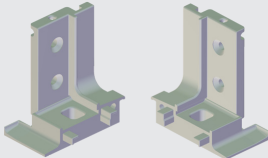
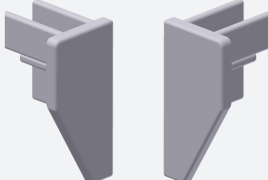
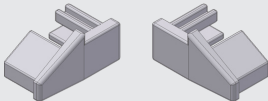
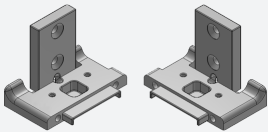

Kunststoffprofile, Formstücke
Plastic profiles, moulded pieces

Artikel Article	VE PU	Anwendung Application	Bezeichnung / Hinweise Designation / Indications	Abbildung Figure
		Material / Material Farbe / Colour	Zuordnung Assignment	
4940473	1 Garn. 1 set	WICSTYLE 65	Schwellenverbinder Garnitur Bestehend aus: 4940471, 4940472 Mit Schwelle abdichten und verschrauben. Verbindungsmittel: 2x 4970072 Bohrschraube 2x 4070048 ST 4,2 x 45	
		PA	Threshold connector set Consists of: 4940471, 4940472 Seal and screw with threshold.	
		grau grey weiß white schwarz black	Connecting device: 2x 4970072, Drilling screw 2x 4070048 St 4,2 x 45 1926547	
4940482	1 Garn. 1 set	WICSTYLE 65evo WICSTYLE 75evo	Endkappe, Garnitur	
		PA	Endcap set	
		schwarz black	3925095	
4940485	10 Garn. 10 set	WICSTYLE 65	Endkappen-Garnitur für Wetterschenkel	
		ABS	Endcap set for weather bar profile	
		schwarz black	3925098	
4940506	1 Garn. 1 set	WICSTYLE 65	Schwellenverbinder Garnitur Bestehend aus: 4940504, 4940505 Mit Schwelle abdichten und verschrauben. Verbindungsmittel: 2x 4970072, 2x 4970074	
		PA	Threshold connector set Consists of: 4940504, 4940505 Seal and screw with threshold.	
		grau grey weiß white schwarz black	Connecting device: 2x 4970072, 2x 4970074	

WICSTYLE 75 evo / 65 evo / 65

Zubehör
Accessories

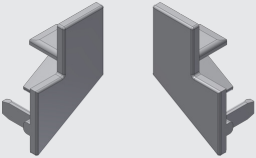

Kunststoffprofile, Formstücke
Plastic profiles, moulded pieces

Artikel Article	VE PU	Anwendung Application	Bezeichnung / Hinweise Designation / Indications	Abbildung Figure
		Material / Material Farbe / Colour	Zuordnung Assignment	
4040807	10 Grt. 10 set	WICSTYLE 65	Endkappe, Garnitur	
		PA	Endcap set	
		grau grey weiß white schwarz black	3020191	
4940538	10 St. 10 pcs	WICSTYLE 65	Entwässerungsventil	
			Drainage valve	
		schwarz black		

WICSTYLE 75 evo / 65 evo / 65

Zubehör
Accessories

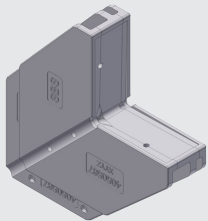
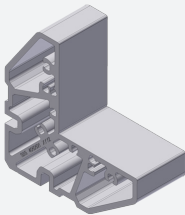
Eckwinkel, Blechteile
Corner angles, Metal sheet parts

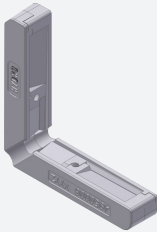
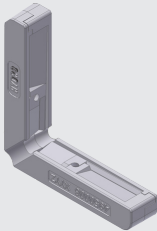
Artikel Article	VE PU	Anwendung Application	Bezeichnung / Hinweise Designation / Indications	Abbildung Figure
		Material / Material Farbe / Colour	Zuordnung Assignment	
4050587	4 St. 4 pcs	WICSTYLE 75evo	Al-Gusseckwinkel Verbindungselement: 2 x 4070000	
			Cast aluminium corner angle Connecting element: 2 x 4070000	
			1020510,1020511,1020515	
4050591	4 St. 4 pcs	WICSTYLE 75evo	Al-Eckwinkel Verbindungselement: 2 x 4070000	
		Al	Corner angle, aluminium Connecting element: 2 x 4070000	
			1020502,1020503,1020504	
4950005	20 St. 20 pcs	WICSTYLE 65evo WICSTYLE 75evo	Al-Gusseckwinkel Verbindungselement: 2 x 4070009	
		Al	Cast Al corner angle Connecting element: 2 x 4070009	
			1916062,1916256,1916258,1916259,1916260 1917062,1917256,1917258,1917259,1917260	
4950006	20 St. 20 pcs	WICSTYLE 65 WICSTYLE 65evo WICSTYLE 75evo	Al-Gusseckwinkel Verbindungselement: 2 x 4070000	
		Al	Cast Al corner angle Connecting element: 2 x 4070000	
			1010187,1916001,1916055,1916068,1916076 1916201,1917001,1917055,1917068,1917076 1917201,1926506,1926507,1927506,1927507	
4950007	20 St. 20 pcs	WICSTYLE 65evo WICSTYLE 75evo	Al-Gusseckwinkel Verbindungselement: 2 x 4070000	
		Al	Cast Al corner angle Connecting element: 2 x 4070000	
			1916002,1916056,1916202,1917002,1917056 1917202	

WICSTYLE 75 evo / 65 evo / 65

Zubehör
Accessories

Eckwinkel, Blechteile
Corner angles, Metal sheet parts

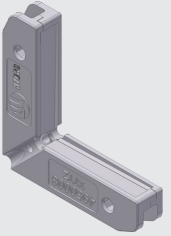
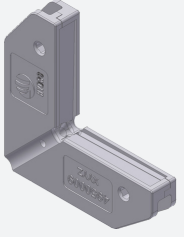
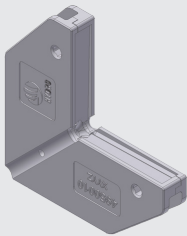
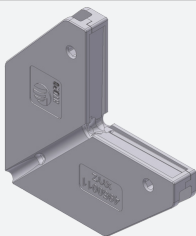
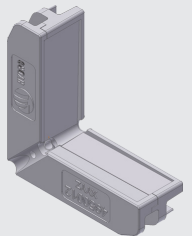
Artikel Article	VE PU	Anwendung Application	Bezeichnung / Hinweise Designation / Indications	Abbildung Figure
		Material / Material Farbe / Colour	Zuordnung Assignment	
4950008	20 St. 20 pcs	WICSTYLE 65	Al-Gusseckwinkel Verbindungselement: 2 x 4070000	
		WICSTYLE 65evo	Cast Al corner angle Connecting element: 2 x 4070000	
		WICSTYLE 75evo	1916003,1916009,1916019,1916057,1916064 1916069,1916073,1916077,1916203,1916241 1916244,1916246,1916247,1916248,1916301 1916303,1917003,1917009,1917057,1917064 1917069,1917073,1917077,1917203,1917241 1917244,1917246,1917247,1917248,1917301 1917303,1926500,1926504,1926541,1927500	
4950009	20 St. 20 pcs	WICSTYLE 65evo	Al-Gusseckwinkel Verbindungselement: 2 x 4070000	
		WICSTYLE 75evo	Cast Al corner angle Connecting element: 2 x 4070000	
			1916004,1916058,1916204,1917004,1917058 1917204	
4950010	20 St. 20 pcs	WICSTYLE 65	Al-Gusseckwinkel Verbindungselement: 2 x 4070000	
		WICSTYLE 65evo	Cast Al corner angle Connecting element: 2 x 4070000	
		WICSTYLE 75evo	1020502,1020503,1020504,1020512,1020513 1916005,1916059,1916205,1916249,1916250 1916251,1917005,1917059,1917205,1917249 1917250,1917251,1926502,1926503,1926505 1926542,1927502	
4950011	20 St. 20 pcs	WICSTYLE 65evo	Al-Gusseckwinkel Verbindungselement: 2 x 4070000	
		WICSTYLE 75evo	Cast Al corner angle Connecting element: 2 x 4070000	
			1916067,1916206,1917067,1917206	
4950012	20 St. 20 pcs	WICSTYLE 65evo	Al-Gusseckwinkel Verbindungselement: 2 x 4070000	
		WICSTYLE 75evo	Cast Al corner angle Connecting element: 2 x 4070000	
			1916009,1917009	

WICSTYLE 75 evo / 65 evo / 65

Zubehör
Accessories

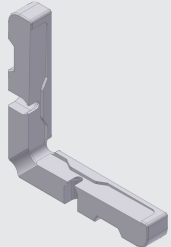
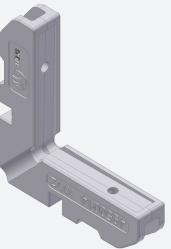
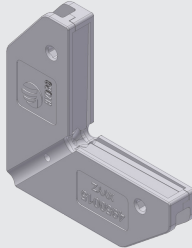
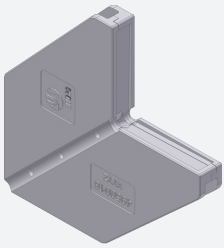
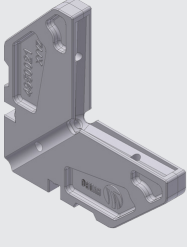

Eckwinkel, Blechteile
Corner angles, Metal sheet parts

Artikel Article	VE PU	Anwendung Application	Bezeichnung / Hinweise Designation / Indications	Abbildung Figure
		Material / Material Farbe / Colour	Zuordnung Assignment	
4950013	20 St. 20 pcs	WICSTYLE 65 WICSTYLE 65evo WICSTYLE 75evo	Al-Gusseckwinkel Verbindungselement: 2 x 4070000	
		Al	Cast Al corner angle Connecting element: 2 x 4070000	
			1916076,1917076,1926506,1926507,1927506 1927507	
4950014	20 St. 20 pcs	WICSTYLE 65evo WICSTYLE 75evo	Al-Gusseckwinkel Verbindungselement: 2 x 4070000	
		Al	Cast Al corner angle Connecting element: 2 x 4070000	
			1916077,1917077	
4950015	20 St. 20 pcs	WICSTYLE 65evo WICSTYLE 75evo	Al-Gusseckwinkel Verbindungselement: 2 x 4070000	
			Cast Al corner angle Connecting element: 2 x 4070000	
			1926501,1927501	
4950016	20 St. 20 pcs	WICSTYLE 65evo WICSTYLE 75evo	Al-Gusseckwinkel Verbindungselement: 2 x 4070000	
			Cast Al corner angle Connecting element: 2 x 4070000	
			1020509,1926512,1926515,1927512,1927515	
4950021	20 St. 20 pcs	WICSTYLE 75evo	Al-Gusseckwinkel Verbindungselement: 2 x 4070000	
		Al	Cast Al corner angle Connecting element: 2 x 4070000	
			1020512,1020513	

WICSTYLE 75 evo / 65 evo / 65

Zubehör
Accessories

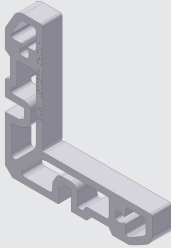
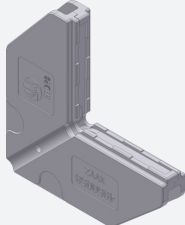
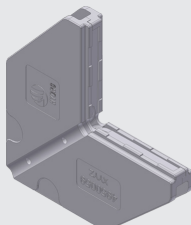
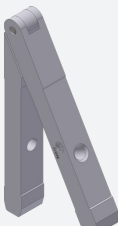
Eckwinkel, Blechteile
Corner angles, Metal sheet parts

Artikel Article	VE PU	Anwendung Application	Bezeichnung / Hinweise Designation / Indications	Abbildung Figure
		Material / Material Farbe / Colour	Zuordnung Assignment	
4950057	4 St. 4 pcs	WICSTYLE 65evo WICSTYLE 75evo	Al-Eckwinkel Aufsatzprofil Fenstertür Verbindungselement: 2 x 4070000	
		Al	Al corner angle Mounting profile casement door, Connecting element: 2 x 4070000	
			1916301,1916303,1917301,1917303	
4950058	20 St. 20 pcs	WICSTYLE 65 WICSTYLE 65evo WICSTYLE 75evo	Al-Gusseckwinkel Verbindungselement: 2 x 4070000	
			Cast Al corner angle Connecting element: 2 x 4070000	
			1020499,1020500,1926510,1926513,1926534 1926535,1926536,1926540,1927510,1927513	
4950059	20 St. 20 pcs	WICSTYLE 65evo WICSTYLE 75evo	Al-Gusseckwinkel Verbindungselement: 2 x 4070000	
			Cast Al corner angle Connecting element: 2 x 4070000	
			1020461,1020510,1020511,1920516,1920517 1926511,1926514,1927511,1927514	
4950060	4 St. 4 pcs	WICSTYLE 65evo WICSTYLE 75evo	Gelenkeckwinkel Verwendung: Vertikalecke Verbindungselement: 2 x 4070002	
			Hinged corner angle Application: Vertical corner Connecting element: 2 x 4070002	
			1010187,1010425,1916001,1916055,1916068 1916201,1917001,1917055,1917068,1917201	
4950061	4 St. 4 pcs	WICSTYLE 65evo WICSTYLE 75evo	Gelenkeckwinkel Verwendung: Vertikalecke Verbindungselement: 2 x 4070002	
			Hinged corner angle Application: Vertical corner Connecting element: 2 x 4070002	
			1916002,1916056,1916202,1917002,1917056 1917202	

WICSTYLE 75 evo / 65 evo / 65

Zubehör
Accessories

Eckwinkel, Blechteile
Corner angles, Metal sheet parts

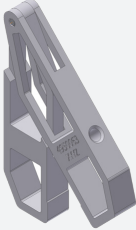
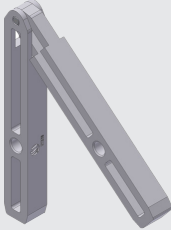
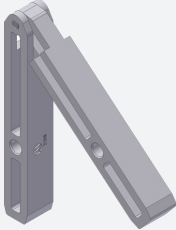
Artikel Article	VE PU	Anwendung Application	Bezeichnung / Hinweise Designation / Indications	Abbildung Figure
		Material / Material Farbe / Colour	Zuordnung Assignment	
4950062	4 St. 4 pcs	WICSTYLE 65evo WICSTYLE 75evo	Gelenkeckwinkel Verwendung: Vertikalecke Verbindungselement: 2 x 4070002	
			Hinged corner angle Application: Vertical corner Connecting element: 2 x 4070002	
			1916003,1916057,1916064,1916069,1916073 1916203,1916241,1916244,1916246,1916247 1916248,1917003,1917057,1917064,1917069 1917073,1917203,1917241,1917244,1917246 1917247,1917248	
4950063	4 St. 4 pcs	WICSTYLE 65evo WICSTYLE 75evo	Gelenkeckwinkel Verwendung: Vertikalecke Verbindungselement: 2 x 4070002	
			Hinged corner angle Application: Vertical corner Connecting element: 2 x 4070002	
			1916004,1916058,1916204,1917004,1917058 1917204	
4950076	4 St. 4 pcs	WICSTYLE 65evo WICSTYLE 75evo	Gelenkeckwinkel Verwendung: Horizontalecke Verbindungselement: 2 x 4070002	
			Hinged corner angle Application: Horizontal corner Connecting element: 2 x 4070002	
			1010187,1010425,1916001,1916055,1916068 1916201,1917001,1917055,1917068,1917201	
4950077	4 St. 4 pcs	WICSTYLE 65evo WICSTYLE 75evo	Gelenkeckwinkel Verwendung: Horizontalecke Verbindungselement: 2 x 4070002	
			Hinged corner angle Application: Horizontal corner Connecting element: 2 x 4070002	
			1916002,1916056,1916202,1917002,1917056 1917202	

WICSTYLE 75 evo / 65 evo / 65

Zubehör
Accessories

Eckwinkel, Blechteile
Corner angles, Metal sheet parts

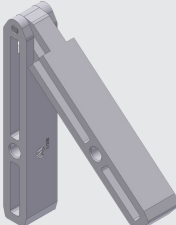
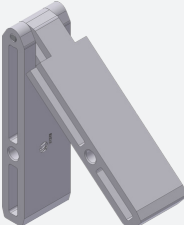
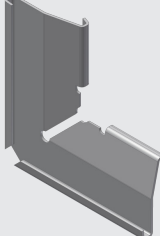
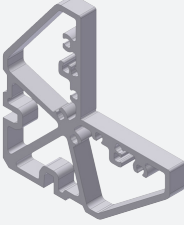
Artikel Article	VE PU	Anwendung Application	Bezeichnung / Hinweise Designation / Indications	Abbildung Figure
		Material / Material Farbe / Colour	Zuordnung Assignment	
4950078	4 St. 4 pcs	WICSTYLE 65evo WICSTYLE 75evo	Gelenkeckwinkel Verwendung: Horizontalecke Verbindungselement: 2 x 4070002	
			Hinged corner angle Application: Horizontal corner Connecting element: 2 x 4070002	
			1916003,1916057,1916064,1916069,1916073 1916203,1916241,1916244,1916246,1916247 1916248,1917003,1917057,1917064,1917069 1917073,1917203,1917241,1917244,1917246 1917247,1917248	
4950079	4 St. 4 pcs	WICSTYLE 65evo WICSTYLE 75evo	Gelenkeckwinkel Verwendung: Horizontalecke Verbindungselement: 2 x 4070002	
			Hinged corner angle, Application: horizontal corner Connecting element: 2 x 4070002	
			1916004,1916058,1916204,1917004,1917058 1917204	
4950082	20 St. 20 pcs	WICSTYLE 65evo WICSTYLE 75evo	Aufsteckwinkel für Einspannblendrahmen Falz 25 mm. Verwendung: Stegverstärkung Außenschale, verkleben.	
		Stahl, rostfrei Stainless steel	Plug on angle for 25 mm rebate of clamping frame. Application: For stabilization of profile web in the mitre joint corners of outer shell, stick.	
			1916076,1916077,1917076,1917077,1926506 1926507,1927506,1927507	
4950328	4 St. 4 pcs	WICSTYLE 65evo WICSTYLE 75evo	Al-Eckwinkel Verbindungselement: 2 x 4070000	
		Al	Corner angle, aluminium Connecting element: 2 x 4070000	
			1020501,1020515,1920512,1920513,1920516 1920517	

WICSTYLE 75 evo / 65 evo / 65

Zubehör
Accessories

Eckwinkel, Blechteile

Corner angles, Metal sheet parts

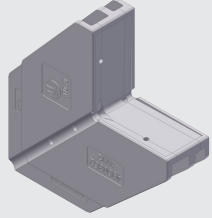
Artikel Article	VE PU	Anwendung Application	Bezeichnung / Hinweise Designation / Indications	Abbildung Figure
		Material / Material Farbe / Colour	Zuordnung Assignment	
4950352	20 St. 20 pcs	WICSTYLE 75evo	Al-Gusseckwinkel Verbindungselement: 2 x 4070000	
			Cast aluminium corner angle, Connecting element: 2 x 4070000	
			1020461,1020501	

WICSTYLE 75 evo / 65 evo / 65

Zubehör
Accessories

Verbinder
Butt-joint connectors

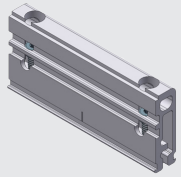
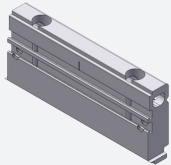
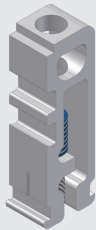
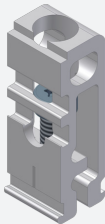
Artikel Article	VE PU	Anwendung Application	Bezeichnung / Hinweise Designation / Indications	Abbildung Figure
		Material / Material Farbe / Colour	Zuordnung Assignment	
4060411	10 St. 10 pcs	WICSTYLE 75evo	Stoßverbinder Falz 25 mm, innen/außen Verbindungselement: 2 x 4070000 Injektionsleitteil: 2 x 4070030	
			Butt-joint connector 25 mm rebate, inside/outside Connecting element: 2 x 4070000 Injection guide part: 2 x 4070030	
			1020508	
4060413	10 St. 10 pcs	WICSTYLE 75evo	Stoßverbinder Falz 25 mm, außen Verbindungselement: 2 x 4070000 Injektionsleitteil: 2 x 4070030	
			Butt-joint connector 25 mm rebate, outside Connecting element: 2 x 4070000 Injection guide part: 2 x 4070030	
			1020508	
4960002	20 St. 20 pcs	WICSTYLE 65evo WICSTYLE 75evo	Stoßverbinder Falz 25 mm, innen/außen Verbindungselement: 1 x 4070000	
			Butt-joint connector 25 mm rebate, inside/outside Connecting element: 1 x 4070000	
			1010187,1916001,1916055,1916068,1916201 1916336,1917001,1917055,1917068,1917201 1917336	
4960003	20 St. 20 pcs	WICSTYLE 65evo WICSTYLE 75evo	Stoßverbinder Falz 25 mm, innen/außen Verbindungselement: 1 x 4070000 Injektionsleitteil: 1 x 4070030	
			Butt-joint connector 25 mm rebate, inside/outside Connecting element: 1 x 4070000 Injection guide part: 1 x 4070030	
			1916002,1916056,1916202,1917002,1917056 1917202	

WICSTYLE 75 evo / 65 evo / 65

Zubehör
Accessories

Verbinder
Butt-joint connectors

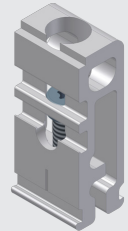
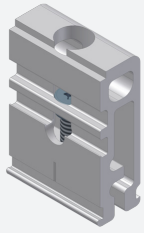
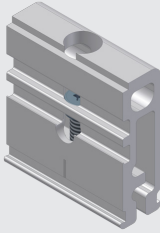
Artikel Article	VE PU	Anwendung Application	Bezeichnung / Hinweise Designation / Indications	Abbildung Figure
		Material / Material Farbe / Colour	Zuordnung Assignment	
4960004	20 St. 20 pcs	WICSTYLE 65evo WICSTYLE 75evo	Stoßverbinder Falz 25 mm, innen/außen Verbindungselement: 1 x 4070000 Injektionsleitteil: 1 x 4070030	
			Butt-joint connector 25 mm rebate, inside/outside Connecting element: 1 x 4070000 Injection guide part: 1 x 4070030	
			1916003,1916009,1916019,1916057,1916064 1916069,1916073,1916203,1916213,1916215 1916220,1916224,1916241,1916244,1916246 1916247,1916248,1916273,1917003,1917009 1917057,1917064,1917069,1917073,1917203 1917213,1917215,1917220,1917224,1917241 1917244,1917246,1917247,1917248	
4960005	20 St. 20 pcs	WICSTYLE 65evo WICSTYLE 75evo	Stoßverbinder Falz 25 mm, innen/außen Verbindungselement: 1 x 4070000 Injektionsleitteil: 1 x 4070030	
			Butt-joint connector 25 mm rebate, inside/outside Connecting element: 1 x 4070000 Injection guide part: 1 x 4070030	
			1916004,1916058,1916204,1917004,1917058 1917204,1917273	
4960006	20 St. 20 pcs	WICSTYLE 65 WICSTYLE 65evo WICSTYLE 75evo	Stoßverbinder Falz 25 mm, innen/außen Verbindungselement: 1 x 4070000 Injektionsleitteil: 1 x 4070030	
			Butt-joint connector 25 mm rebate, inside/outside Connecting element: 1 x 4070000 Injection guide part: 1 x 4070030	
			1020503,1020504,1916005,1916059,1916205 1916249,1916250,1916251,1916270,1916271 1916272,1917005,1917059,1917205,1917249 1917250,1917251,1926534,1926540	

WICSTYLE 75 evo / 65 evo / 65

Zubehör
Accessories

Verbinder
Butt-joint connectors

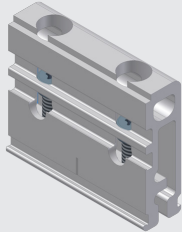
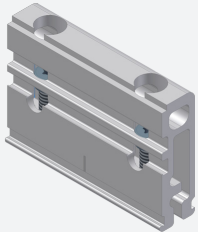
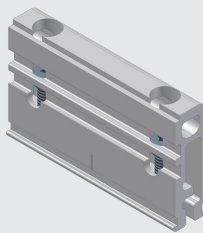
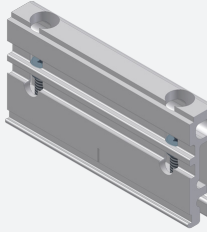
Artikel Article	VE PU	Anwendung Application	Bezeichnung / Hinweise Designation / Indications	Abbildung Figure
		Material / Material Farbe / Colour	Zuordnung Assignment	
4960007	20 St. 20 pcs	WICSTYLE 65evo	Stoßverbinder Falz 25 mm, innen/außen Verbindungselement: 2 x 4070000 Injektionsleitteil: 2 x 4070030	
		WICSTYLE 75evo	Butt-joint connector 25 mm rebate, inside/outside Connecting element: 2 x 4070000 Injection guide part: 2 x 4070030	
			1916067,1916206,1917067,1917206,1917270 1917271,1917272	
4960008	10 St. 10 pcs	WICSTYLE 65evo	Stoßverbinder Falz 25 mm, innen/außen Verbindungselement: 2 x 4070000 Injektionsleitteil: 2 x 4070030	
		WICSTYLE 75evo	Butt-joint connector 25 mm rebate, inside/outside Connecting element: 2 x 4070000 Injection guide part: 2 x 4070030	
			1916060,1916207,1916213,1917060,1917207 1917213	
4960009	10 St. 10 pcs	WICSTYLE 65evo	Stoßverbinder Falz 25 mm, innen/außen Verbindungselement: 2 x 4070000 Injektionsleitteil: 2 x 4070030	
		WICSTYLE 75evo	Butt-joint connector 25 mm rebate, inside/outside Connecting element: 2 x 4070000 Injection guide part: 2 x 4070030	
			1916215,1917215	
4960010	10 St. 10 pcs	WICSTYLE 65evo	Stoßverbinder Falz 25 mm, innen/außen Verbindungselement: 2 x 4070000 Injektionsleitteil: 2 x 4070030	
		WICSTYLE 75evo	Butt-joint connector 25 mm rebate, inside/outside Connecting element: 2 x 4070000 Injection guide part: 2 x 4070030	
			1916209,1917209	

WICSTYLE 75 evo / 65 evo / 65

Zubehör
Accessories

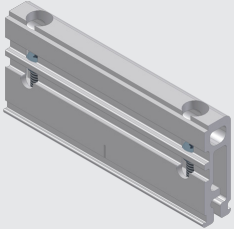
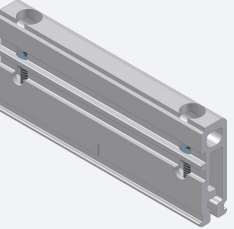
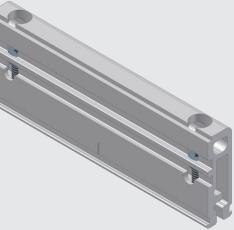
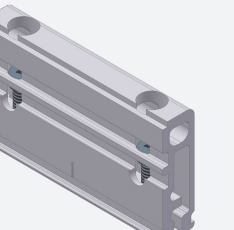

Verbinder
Butt-joint connectors

Artikel Article	VE PU	Anwendung Application	Bezeichnung / Hinweise Designation / Indications	Abbildung Figure
		Material / Material Farbe / Colour	Zuordnung Assignment	
4960011	10 St. 10 pcs	WICSTYLE 65evo	Stoßverbinder Falz 25 mm, innen/außen Verbindungselement: 2 x 4070000 Injektionsleitteil: 2 x 4070030	
		WICSTYLE 75evo	Butt-joint connector 25 mm rebate, inside/outside Connecting element: 2 x 4070000 Injection guide part: 2 x 4070030	
			1916220,1917220	
4960012	10 St. 10 pcs	WICSTYLE 65evo	Stoßverbinder Falz 25 mm, innen/außen Verbindungselement: 2 x 4070000 Injektionsleitteil: 2 x 4070030	
		WICSTYLE 75evo	Butt-joint connector 25 mm rebate, inside/outside Connecting element: 2 x 4070000 Injection guide part: 2 x 4070030	
			1916211,1917211	
4960013	10 St. 10 pcs	WICSTYLE 65evo	Stoßverbinder Falz 25 mm, innen/außen Verbindungselement: 2 x 4070000 Injektionsleitteil: 2 x 4070030	
		WICSTYLE 75evo	Butt-joint connector 25 mm rebate, inside/outside Connecting element: 2 x 4070000 Injection guide part: 2 x 4070030	
			1916224,1917224	
4960014	10 St. 10 pcs	WICSTYLE 65evo	Stoßverbinder Falz 25 mm, innen Verbindungselement: 2 x 4070000 Injektionsleitteil: 2 x 4070030	
		WICSTYLE 75evo	Butt-joint connector 25 mm rebate, inside Connecting element: 2 x 4070000 Injection guide part: 2 x 4070030	
			1926516,1927516	

WICSTYLE 75 evo / 65 evo / 65

Zubehör
Accessories

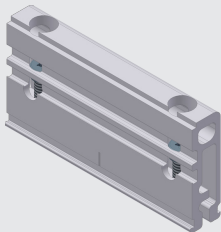
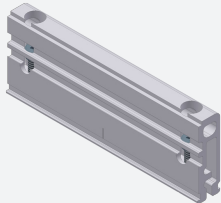
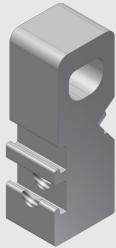
Verbinder
Butt-joint connectors

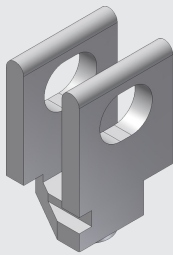
Artikel Article	VE PU	Anwendung Application	Bezeichnung / Hinweise Designation / Indications	Abbildung Figure
		Material / Material Farbe / Colour	Zuordnung Assignment	
4960015	10 St. 10 pcs	WICSTYLE 65evo	Stoßverbinder Falz 25 mm, innen Verbindungselement: 2 x 4070000 Injektionsleitteil: 2 x 4070030	
		WICSTYLE 75evo	Butt-joint connector 25 mm rebate, inside Connecting element: 2 x 4070000 Injection guide part: 2 x 4070030	
			1926517,1926519,1927517	
4960016	10 St. 10 pcs	WICSTYLE 65evo	Stoßverbinder Falz 25 mm, innen Verbindungselement: 2 x 4070000 Injektionsleitteil: 2 x 4070030	
		WICSTYLE 75evo	Butt-joint connector 25 mm rebate, inside Connecting element: 2 x 4070000 Injection guide part: 2 x 4070030	
			1926518,1927518	
4960035	10 St. 10 pcs	WICSTYLE 65evo	Stoßverbinder Falz 18 mm, außen Verbindungselement: 1 x 4070000	
		WICSTYLE 75evo	Butt-joint connector 18 mm rebate, outside Connecting element: 1 x 4070000	
			1010187,1916336,1917336	
4960037	10 St. 10 pcs	WICSTYLE 65evo	Stoßverbinder Falz 18 mm, außen Verbindungselement: 2 x 4070000, 1 x 4070063	
		WICSTYLE 75evo	Butt-joint connector 18 mm rebate, outside Connecting element: 2 x 4070000, 1 x 4070063	
		Al	1916338,1917338	
4060056	1 St. 1 pcs	WICSTYLE 65evo	Stoßverbinder Sprossenverbinder innen Verbindungselement: 1 x 4070000	
		WICSTYLE 75evo	Butt-joint connector Glazing bar connector, inside Connecting element: 1 x 4070000	
			1916336,1916338,1917336,1917338	

WICSTYLE 75 evo / 65 evo / 65

Zubehör
Accessories

Verbinder
Butt-joint connectors

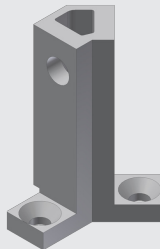
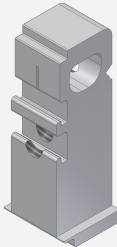
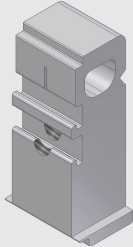
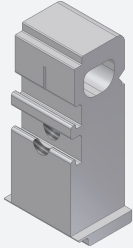
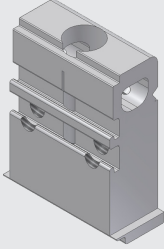
Artikel Article	VE PU	Anwendung Application	Bezeichnung / Hinweise Designation / Indications	Abbildung Figure
		Material / Material Farbe / Colour	Zuordnung Assignment	
4960050	10 St. 10 pcs	WICSTYLE 65evo WICSTYLE 75evo	Stoßverbinder 135° Ecke Falz 25 mm, innen Verbindungselement: 2 x 4070009, 2 x 4070067	
		Al	Butt-joint connector for 135° corner 25 mm rebate, inside Connecting element: 2 x 4070009, 2 x 4070067	
			1916273,1917273	
4960052	10 St. 10 pcs	WICSTYLE 65evo WICSTYLE 75evo	Stoßverbinder Falz 25 mm, außen Verbindungselement: 1 x 4070000	
			Butt-joint connector 25 mm rebate, outside Connecting element: 1 x 4070000	
			1916201,1916336,1917201,1917336	
4960053	10 St. 10 pcs	WICSTYLE 65evo WICSTYLE 75evo	Stoßverbinder Falz 25 mm, außen Verbindungselement: 1 x 4070000	
			Butt-joint connector 25 mm rebate, outside Connecting element: 1 x 4070000	
			1916202,1917202	
4960054	10 St. 10 pcs	WICSTYLE 65evo WICSTYLE 75evo	Stoßverbinder Falz 25 mm, außen Verbindungselement: 1 x 4070000	
			Butt-joint connector 25 mm rebate, outside Connecting element: 1 x 4070000	
			1916203,1917203	
4960055	10 St. 10 pcs	WICSTYLE 65evo WICSTYLE 75evo	Stoßverbinder Falz 25 mm, außen Verbindungselement: 1 x 4070000 Injektionsleitteil: 1 x 4070030	
			Butt-joint connector 25 mm rebate, outside Connecting element: 1 x 4070000 Injection guide part: 1 x 4070030	
			1916204,1917204	

WICSTYLE 75 evo / 65 evo / 65

Zubehör
Accessories

Verbinder
Butt-joint connectors

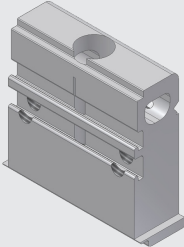
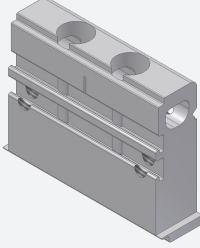
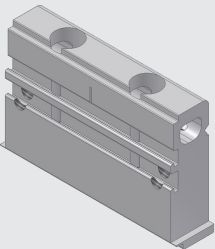
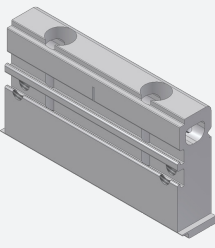
Artikel Article	VE PU	Anwendung Application	Bezeichnung / Hinweise Designation / Indications	Abbildung Figure
		Material / Material Farbe / Colour	Zuordnung Assignment	
4960056	10 St. 10 pcs	WICSTYLE 65	Stoßverbinder Falz 25 mm, außen Verbindungselement: 1 x 4070000 Injektionsleitteil: 1 x 4070030	
		WICSTYLE 65evo	Butt-joint connector 25 mm rebate, outside Connecting element: 1 x 4070000 Injection guide part: 1 x 4070030	
		WICSTYLE 75evo		
			1916205,1917205,1926534,1926540	
4960057	10 St. 10 pcs	WICSTYLE 65evo	Stoßverbinder Falz 25 mm, außen Verbindungselement: 2 x 4070000 Injektionsleitteil: 2 x 4070030	
		WICSTYLE 75evo	Butt-joint connector 25 mm rebate, outside Connecting element: 2 x 4070000 Injection guide part: 2 x 4070030	
			1916206,1917206	
4960058	10 St. 10 pcs	WICSTYLE 65evo	Stoßverbinder Falz 25 mm, außen Verbindungselement: 2 x 4070000 Injektionsleitteil: 2 x 4070030	
		WICSTYLE 75evo	Butt-joint connector 25 mm rebate, outside Connecting element: 2 x 4070000 Injection guide part: 2 x 4070030	
			1916207,1916213,1917207,1917213	
4960059	10 St. 10 pcs	WICSTYLE 65evo	Stoßverbinder Falz 25 mm, außen Verbindungselement: 2 x 4070000 Injektionsleitteil: 2 x 4070030	
		WICSTYLE 75evo	Butt-joint connector 25 mm rebate, outside Connecting element: 2 x 4070000 Injection guide part: 2 x 4070030	
			1916215,1917215	

WICSTYLE 75 evo / 65 evo / 65

Zubehör
Accessories

Verbinder
Butt-joint connectors

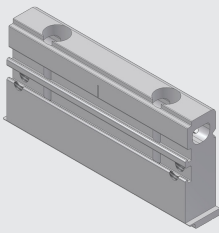
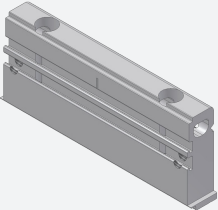
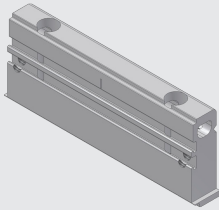
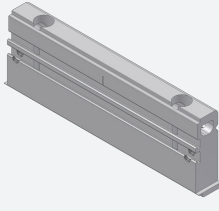
Artikel Article	VE PU	Anwendung Application	Bezeichnung / Hinweise Designation / Indications	Abbildung Figure
		Material / Material Farbe / Colour	Zuordnung Assignment	
4960060	10 St. 10 pcs	WICSTYLE 65evo	Stoßverbinder Falz 25 mm, außen Verbindungselement: 2 x 4070000 Injektionsleitteil: 2 x 4070030	
		WICSTYLE 75evo	Butt-joint connector 25 mm rebate, outside Connecting element: 2 x 4070000 Injection guide part: 2 x 4070030	
			1916209,1917209	
4960061	10 St. 10 pcs	WICSTYLE 65evo	Stoßverbinder Falz 25 mm, außen Verbindungselement: 2 x 4070000 Injektionsleitteil: 2 x 4070030	
		WICSTYLE 75evo	Butt-joint connector 25 mm rebate, outside Connecting element: 2 x 4070000 Injection guide part: 2 x 4070030	
			1916220,1917220	
4960062	10 St. 10 pcs	WICSTYLE 65evo	Stoßverbinder Falz 25 mm, außen Verbindungselement: 2 x 4070000 Injektionsleitteil: 2 x 4070030	
		WICSTYLE 75evo	Butt-joint connector 25 mm rebate, outside Connecting element: 2 x 4070000 Injection guide part: 2 x 4070030	
			1916211,1917211	
4960063	10 St. 10 pcs	WICSTYLE 65evo	Stoßverbinder Falz 25 mm, außen Verbindungselement: 2 x 4070000 Injektionsleitteil: 2 x 4070030	
		WICSTYLE 75evo	Butt-joint connector 25 mm rebate, outside Connecting element: 2 x 4070000 Injection guide part: 2 x 4070030	
			1916224,1917224	

WICSTYLE 75 evo / 65 evo / 65

Zubehör
Accessories

Verbinder
Butt-joint connectors

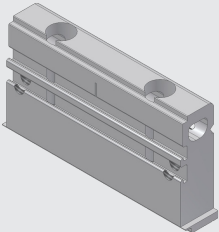
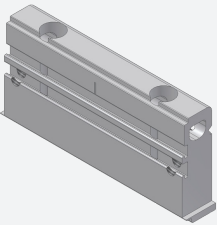
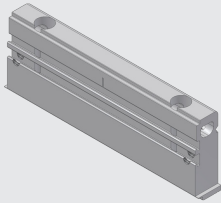
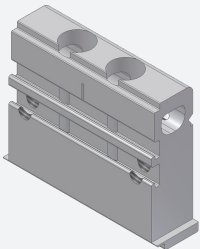
Artikel Article	VE PU	Anwendung Application	Bezeichnung / Hinweise Designation / Indications	Abbildung Figure
		Material / Material Farbe / Colour	Zuordnung Assignment	
4960064	10 St. 10 pcs	WICSTYLE 65evo WICSTYLE 75evo	Stoßverbinder Falz 25 mm, außen Verbindungselement: 2 x 4070000 Injektionsleitteil: 2 x 4070030	
			Butt-joint connector 25 mm rebate, outside Connecting element: 2 x 4070000 Injection guide part: 2 x 4070030	
			1926516,1927516	
4960065	10 St. 10 pcs	WICSTYLE 65evo WICSTYLE 75evo	Stoßverbinder Falz 25 mm, außen Verbindungselement: 2 x 4070000 Injektionsleitteil: 2 x 4070030	
			Butt-joint connector 25 mm rebate, outside Connecting element: 2 x 4070000 Injection guide part: 2 x 4070030	
			1926517,1926519,1927517	
4960066	10 St. 10 pcs	WICSTYLE 65evo WICSTYLE 75evo	Stoßverbinder Falz 25 mm, außen Verbindungselement: 2 x 4070000 Injektionsleitteil: 2 x 4070030	
			Butt-joint connector 25 mm rebate, outside Connecting element: 2 x 4070000 Injection guide part: 2 x 4070030	
			1926518,1927518	
4960067	10 St. 10 pcs	WICSTYLE 65 WICSTYLE 65evo WICSTYLE 75evo	Stoßverbinder Falz 25 mm, außen Verbindungselement: 1 x 4070000 Injektionsleitteil: 1 x 4070030	
			Butt-joint connector 25 mm rebate, outside Connecting element: 1 x 4070000 Injection guide part: 1 x 4070030	
			1926527,1927527	

WICSTYLE 75 evo / 65 evo / 65

Zubehör
Accessories



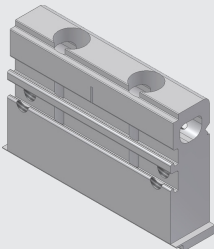
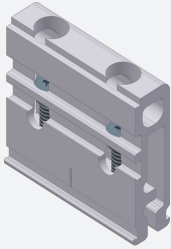
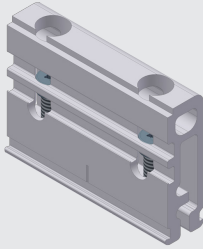
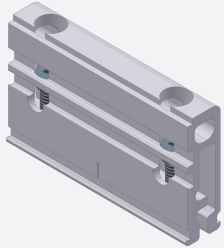

Verbinder
Butt-joint connectors

Artikel Article	VE PU	Anwendung Application	Bezeichnung / Hinweise Designation / Indications	Abbildung Figure
		Material / Material Farbe / Colour	Zuordnung Assignment	
4960068	10 St. 10 pcs	WICSTYLE 65evo WICSTYLE 75evo	Stoßverbinder Falz 25 mm, außen Verbindungselement: 1 x 4070000 Injektionsleitteil: 1 x 4070030	
			Butt-joint connector 25 mm rebate, outside Connecting element: 1 x 4070000 Injection guide part: 1 x 4070030	
			1926528,1927528	
4960069	10 St. 10 pcs	WICSTYLE 65 WICSTYLE 65evo WICSTYLE 75evo	Stoßverbinder Falz 25 mm, außen Verbindungselement: 1 x 4070000 Injektionsleitteil: 1 x 4070030	
			Butt-joint connector 25 mm rebate, outside Connecting element: 1 x 4070000 Injection guide part: 1 x 4070030	
			1926527,1927527	
4960070	10 St. 10 pcs	WICSTYLE 65evo WICSTYLE 75evo	Stoßverbinder Falz 25 mm, außen Verbindungselement: 1 x 4070000 Injektionsleitteil: 1 x 4070030	
			Butt-joint connector 25 mm rebate, outside Connecting element: 1 x 4070000 Injection guide part: 1 x 4070030	
			1926528,1927528	
4960071	10 St. 10 pcs	WICSTYLE 65 WICSTYLE 65evo WICSTYLE 75evo	Stoßverbinder Falz 25 mm, innen Verbindungselement: 2 x 4070000 Injektionsleitteil: 2 x 4070030	
			Butt-joint connector 25 mm rebate, inside Connecting element: 2 x 4070000 Injection guide part: 2 x 4070030	
			1926527,1927527	

WICSTYLE 75 evo / 65 evo / 65

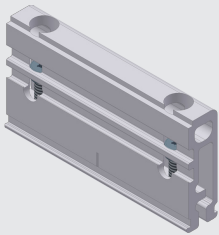
Zubehör
Accessories





Verbinder
Butt-joint connectors

Artikel Article	VE PU	Anwendung Application	Bezeichnung / Hinweise Designation / Indications	Abbildung Figure
		Material / Material Farbe / Colour	Zuordnung Assignment	
4960072	10 St. 10 pcs	WICSTYLE 65evo WICSTYLE 75evo	Stoßverbinder Falz 25 mm, innen Verbindungselement: 2 x 4070000 Injektionsleitteil: 2 x 4070030	
			Butt-joint connector 25 mm rebate, inside Connecting element: 2 x 4070000 Injection guide part: 2 x 4070030	
			1926528,1927528	
4960040	4 St. 4 pcs	WICSTYLE 65evo WICSTYLE 75evo	Gelenkverbinder innen Verbindungselement: 1 x 4070002	
			Hinged connector inside Connecting element: 1 x 4070002	
			1010187,1010425,1916001,1916055,1916068 1916201,1917001,1917055,1917068,1917201	
4960041	4 St. 4 pcs	WICSTYLE 65evo WICSTYLE 75evo	Gelenkverbinder innen Verbindungselement: 1 x 4070002	
			Hinged connector inside Connecting element: 1 x 4070002	
			1916002,1916056,1916202,1917002,1917056 1917202	
4960042	4 St. 4 pcs	WICSTYLE 65evo WICSTYLE 75evo	Gelenkverbinder innen Verbindungselement: 1 x 4070002	
			Hinged connector inside Connecting element: 1 x 4070002	
			1916003,1916057,1916064,1916069,1916073 1916203,1916241,1916244,1916246,1916247 1916248,1917003,1917057,1917064,1917069 1917073,1917203,1917241,1917244,1917246 1917247,1917248	
4960043	4 St. 4 pcs	WICSTYLE 65evo WICSTYLE 75evo	Gelenkverbinder innen Verbindungselement: 1 x 4070002	
			Hinged connector inside Connecting element: 1 x 4070002	
			1916004,1916058,1916204,1917004,1917058 1917204	

WICSTYLE 75 evo / 65 evo / 65

Zubehör
Accessories

Verbinder
Butt-joint connectors

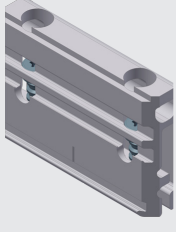
Artikel Article	VE PU	Anwendung Application	Bezeichnung / Hinweise Designation / Indications	Abbildung Figure
		Material / Material Farbe / Colour	Zuordnung Assignment	
4960045	4 St. 4 pcs	WICSTYLE 65evo WICSTYLE 75evo	Gelenkverbinder außen Verbindungselement: 1 x 4070002	
			Hinged connector outside Connecting element: 1 x 4070002	
			1010187,1010425,1916001,1916055,1916068 1916201,1917001,1917055,1917068,1917201	
4960046	4 St. 4 pcs	WICSTYLE 65evo WICSTYLE 75evo	Gelenkverbinder außen Verbindungselement: 1 x 4070002	
			Hinged connector outside Connecting element: 1 x 4070002	
			1916002,1916056,1916202,1917002,1917056 1917202	
4960047	4 St. 4 pcs	WICSTYLE 65evo WICSTYLE 75evo	Gelenkverbinder außen Verbindungselement: 1 x 4070002	
			Hinged connector outside Connecting element: 1 x 4070002	
			1916003,1916057,1916064,1916069,1916073 1916203,1916241,1916244,1916246,1916247 1916248,1917003,1917057,1917064,1917069 1917073,1917203,1917241,1917244,1917246 1917247,1917248	
4960048	4 St. 4 pcs	WICSTYLE 65evo WICSTYLE 75evo	Gelenkverbinder außen Verbindungselement: 1 x 4070002	
			Hinged connector outside Connecting element: 1 x 4070002	
			1916004,1916058,1916204,1917004,1917058 1917204	
4960201	4 St. 4 pcs	WICSTYLE 65 WICSTYLE 65evo	Stoßverbinder Falz 25 mm, innen/außen Verbindungselement: 2 x 4070000 Injektionsleitteil: 2 x 4070030	
			Butt-joint connector 25 mm rebate, inside/outside Connecting element: 2 x 4070000 Injection guide part: 2 x 4070030	
			1926544	

WICSTYLE 75 evo / 65 evo / 65

Zubehör
Accessories

Verbindungselemente / Schrauben
Connecting components / Screws

Artikel Article	VE PU	Anwendung Application	Bezeichnung / Hinweise Designation / Indications	Abbildung Figure
		Material / Material Farbe / Colour	Zuordnung Assignment	
198057	100 St. 100 pcs	WICSTYLE 65evo WICSTYLE 75evo	Stanzschraube M8 x 15.5 mm Vorwiegend in inneren Verbindern.	
		Stahl rostfrei, A2 Stainless steel, A2	Punch screw M8 x 15.5 mm Mainly in inner connectors.	
4070000	100 St. 100 pcs	WICSTYLE 65 WICSTYLE 65evo WICSTYLE 75evo	Hülse Ø6 x 10 mm Setzdorn 5060053 / 5060055	
		Stahl, rostfrei Stainless steel	Bush Ø6 x 10 mm Mandrel for drive bush 5060053 / 5060055	
4070002	100 St. 100 pcs	WICSTYLE 65 WICSTYLE 65evo WICSTYLE 75evo	Kegelschraube Ø6.6 x 9.5 T25	
		Stahl rostfrei, A1 Stainless steel, A1	Screwed bush Ø6.6 x 9.5 T25	
186131	100 St. 100 pcs	WICSTYLE 65evo WICSTYLE 75evo	Senkkopf-Einnietmutter, M5 x 12 mm Für Wanddicken von 1.7 bis 3.0 mm.	
		Al	Countersunk blind rivet nut M5 x 12 mm For profile wall thicknesses of 1.7 up to 3.0 mm.	
4070008	100 St. 100 pcs	WICSTYLE 65evo WICSTYLE 75evo	Hülse Ø6 x 10 mm Hülse ohne Bund.	
		Stahl, rostfrei Stainless steel	Bush Ø6 x 10 mm Bush without collar.	
4070009	100 St. 100 pcs	WICSTYLE 65evo WICSTYLE 75evo	Hülse (kurz) Ø6 x 7 mm Schlaghülse 5060053/5060055	
		Stahl, rostfrei Stainless steel	Drive bush (short) Ø6 x 7 mm Drive bush 5060053/5060055	

WICSTYLE 75 evo / 65 evo / 65

Zubehör
Accessories

Verbindungselemente / Schrauben
Connecting components / Screws

Artikel Article	VE PU	Anwendung Application	Bezeichnung / Hinweise Designation / Indications	Abbildung Figure
		Material / Material Farbe / Colour	Zuordnung Assignment	
4070010	100 St. 100 pcs	WICSTYLE 65evo WICSTYLE 75evo	Zylinderkopfschraube M6 x 13.5 mm T25 Torx 25	
		Stahl rostfrei, A2 Stainless steel, A2	Socket-head cap screw M6 x 13.5 mm T25 Torx 25	
4070011	100 St. 100 pcs	WICSTYLE 65evo WICSTYLE 75evo	Gewindestift M5 x 12 mm T8 Torx 8	
		Stahl Steel	Threaded pin M5 x 12 mm T8 Torx 8	
4070012	100 St. 100 pcs	WICSTYLE 65evo WICSTYLE 75evo	Zylinderkopfschraube M5 x 9 mm T10 Torx 10	
		Stahl rostfrei, A2 Stainless steel, A2	Socket-head cap screw M5 x 9 mm T10 Torx 10	
4070017	50 St. 50 pcs	WICSTYLE 65evo WICSTYLE 75evo	Senkkopfschraube M5 x 6, T25	
		Stahl rostfrei, A2 Stainless steel, A2	Countersunk head screw M5 x 6, T25	
4070013	100 St. 100 pcs	WICSTYLE 65evo WICSTYLE 75evo	Gewindestift M5 x 4.5 mm T10 Torx 10	
		Stahl Steel	Grub screw M5 x 4.5 mm T10 Torx 10	
4070036	100 St. 100 pcs	WICSTYLE 65evo WICSTYLE 75evo	Stanzschraube M6 x 15 mm Torx 15	
		Stahl Steel	Punch screw M6 x 15 mm Torx 15	

WICSTYLE 75 evo / 65 evo / 65

Zubehör
Accessories

Verbindungselemente / Schrauben
Connecting components / Screws

Artikel Article	VE PU	Anwendung Application	Bezeichnung / Hinweise Designation / Indications	Abbildung Figure
		Material / Material Farbe / Colour	Zuordnung Assignment	
4070448	100 St. 100 pcs	WICSTYLE 65 WICSTYLE 65evo WICSTYLE 75evo	Bohrschraube ST3.9 x 13, T15 Der Einsatz des Bit 5960012 wird wegen besserer Führung empfohlen!	
		Stahl rostfrei, A2 Stainless steel, A2	Drilling screw ST3.9 x 13, T15 The usage of the tool 5960012 is recommended due to the better guidance.	
4970073	100 St. 100 pcs	WICSTYLE 65 WICSTYLE 65evo WICSTYLE 75evo	Bohrschraube mit Linsenkopf, ST4.2 x 20, T20 Der Einsatz des Bit 5960013 wird wegen besserer Führung empfohlen!	
		Stahl, rostfrei Stainless steel	Drilling screw ST4.2 x 20, T20 The usage of the bit-tool 5960013 is due to the better guidance recommended.	
4970077	100 St. 100 pcs	WICSTYLE 65 WICSTYLE 65evo WICSTYLE 75evo	Bohrschraube ST4.2 x 24, T20 Der Einsatz des Bit 5960013 wird wegen besserer Führung empfohlen!	
		Stahl rostfrei, A2 Stainless steel, A2	Drilling screw ST4.2 x 24, T20 The usage of the tool 5960013 is due to the better guidance recommended.	
4970078	100 St. 100 pcs	WICSTYLE 65 WICSTYLE 65evo WICSTYLE 75evo	Bohrschraube ST4.2 x 34, T20 Der Einsatz des Bit 5960013 wird wegen besserer Führung empfohlen!	
		Stahl rostfrei, A2 Stainless steel, A2	Drilling screw ST4.2 x 34, T20 The usage of the tool 5960013 is due to the better guidance recommended.	
4970079	100 St. 100 pcs	WICSTYLE 65 WICSTYLE 65evo WICSTYLE 75evo	Bohrschraube ST4.2 x 35, T20 Der Einsatz des Bit 5960013 wird wegen besserer Führung empfohlen!	
		Stahl rostfrei, A2 Stainless steel, A2	Drilling screw ST4.2 x 35, T20 The usage of the tool 5960013 is due to the better guidance recommended.	

WICSTYLE 75 evo / 65 evo / 65

Zubehör
Accessories



Verbindungselemente / Schrauben
Connecting components / Screws

Artikel Article	VE PU	Anwendung Application	Bezeichnung / Hinweise Designation / Indications	Abbildung Figure
		Material / Material Farbe / Colour	Zuordnung Assignment	
4970072	100 St. 100 pcs	WICSTYLE 65 WICSTYLE 65evo WICSTYLE 75evo	Bohrschraube mit Senkkopf, 5x28 T20 Zur Befestigung von Beschlagartikeln im Dämmsteg mit Schraubkanal. Der Einsatz des Bit 5960013 wird wegen besserer Führung empfohlen!	
		Stahl, rostfrei Stainless steel	Drilling screw, countersunk, 5x28 T20 To fix fitting parts in the insulation strip with screw channel. The usage of the tool 5960013 is due to the better guidance recommended.	

WICSTYLE 75 evo / 65 evo / 65

Zubehör
Accessories

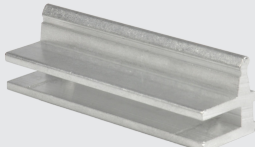
Verschiedenes
Miscellaneous

Artikel Article	VE PU	Anwendung Application	Bezeichnung / Hinweise Designation / Indications	Abbildung Figure
		Material / Material Farbe / Colour	Zuordnung Assignment	
4080446	10 St. 10 pcs	WICSTYLE 75evo	Befestigungsteil	
		Al	Fastener Part	
			1010463,1010464,1020512,1020513	
4080447	10 St. 10 pcs	WICSTYLE 75evo	Befestigungsteil	
		Al	Fastener Part	
			1010463,1010464,1020512,1020513	
4080448	10 St. 10 pcs	WICSTYLE 75evo	Befestigungsteil	
		Al	Fastener part	
			1010463,1010464,1020512,1020513	
4090001	2 m 2 m	WICSTYLE 65evo WICSTYLE 75evo	Dämmteil Verwendung: Im Sockelbereich mit Aufsatzprofilen. 17 x 35 mm	
			Thermal break block Application: In area of bottom rail with supplementary profiles. 17 x 35 mm	
4900188	10 St. 10 pcs	WICSTYLE 65evo WICSTYLE 75evo	Kennzeichnungsschild, EH, Al Anwendung: einbruchhemmende Türen, Klassen WK1, WK2, WK3 Befestigung dauerhaft im Türfalz	
		Al	Identification marking plate, Al Application: burglary resistant doors, class WK1, WK2, WK3 Fasten clearly visible in door rebate	

Verschiedenes
Miscellaneous

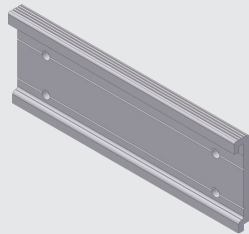
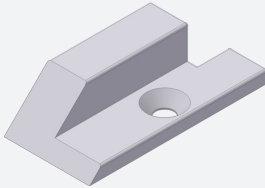
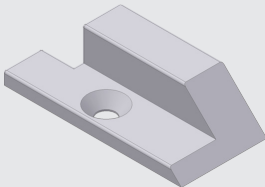
Artikel Article	VE PU	Anwendung Application	Bezeichnung / Hinweise Designation / Indications	Abbildung Figure
		Material / Material Farbe / Colour	Zuordnung Assignment	
4980067	10 St. 10 pcs	WICSTYLE 65evo WICSTYLE 75evo	Klemmprofil zur Befestigung von Zusatzprofilen Verbindungselement: 4x 4070062 ST 3.9 x 9.5, durchschusshemmend Montage mit Bohrschablone 5910081	
		Al	Clamping profile for fixing of additional profiles	
		roh untreated	Connecting element: 4x 4070062 ST 3.9 x 9.5, bullet-resistance Mounting with drill template 5910081	
4980084	1 St. 1 pcs	WICSTYLE 65evo WICSTYLE 75evo	Abschlussstück rechts für 2-flügelige Anschlagtüre, durchschusshemmend, Stulpflügel DIN Rechts, ein-/auswärts (ohne Aufsatzprofil) Verbindungsmittel: 1x 4070053 Bearbeitung: Pulverbeschichtung, Eloxal	
		Al	End piece right for double leaf hinged door, bullet resistance, inactive leaf DIN right, inward-/outwards (without supplementary profile)	
		roh untreated	Connection device: 1x 4070053 Processing: Powder coating, anodic oxidation	
4980085	1 St. 1 pcs	WICSTYLE 65evo WICSTYLE 75evo	Abschlussstück links für 2-flügelige Anschlagtüre, durchschusshemmend, bei Stulpflügel DIN Links, ein-/auswärts (ohne Stulpauflaufprofil) Verbindungsmittel: 1x 4070053 Bearbeitung: Pulverbeschichtung, Eloxal	
		Al	End piece left for double leaf hinged door, bullet resistance, inactive leaf DIN left, inward-/outwards (without supplementary profile)	
		roh untreated	Connection device: 1x 4070053 Processing: Powder coating, anodic oxidation	

WICSTYLE 75 evo / 65 evo / 65

Zubehör
Accessories

Verbindungselemente
Connecting components

Artikel Article			VE PU	Bezeichnung Designation	Abbildung Figure
4070169	T15	ST3.5 x 6.5	100 St.	Linsenblechschraube	
4070170	T15	ST3.5 x 19	100 St.	ähnlich DIN ISO 7049	
4070062	T15	ST3.9 x 9.5	100 St.	Stahl rostfrei, A2	
4070040	T15	ST3.9 x 13	100 St.		
4070041	T15	ST3.9 x 19	100 St.	<i>Self-tapping pan head screw</i>	
4070043	T15	ST3.9 x 25	100 St.	<i>similar DIN ISO 7049</i>	
4070044	T20	ST3.9 x 50	100 St.	<i>Stainless steel, A2</i>	
4070045	T20	ST4.2 x 9.5	100 St.		
4070046	T20	ST4.2 x 13	100 St.		
4070225	T20	ST4.2 x 22	100 St.		
4070047	T20	ST4.2 x 25	100 St.		
4070048	T20	ST4.2 x 45	100 St.		
4070049	T20	ST4.2 x 50	100 St.		
4070059	T20	ST4.2 x 55	100 St.		
4070060	T20	ST4.2 x 60	100 St.		
4070175	T25	ST4.8 x 9.5	100 St.		
4070176	T25	ST4.8 x 11	100 St.		
4070025	T25	ST4.8 x 13	100 St.		
4070026	T25	ST4.8 x 16	100 St.		
4070027	T25	ST4.8 x 23	100 St.		
4070161	T25	ST4.8 x 25	100 St.		
4070050	T25	ST4.8 x 32	100 St.		
4070051	T25	ST4.8 x 60	100 St.		
4070231	T25	ST4.8 x 65	100 St.		
4070080	T25	ST5.5 x 23	100 St.		
4070081	T25	ST5.5 x 29	100 St.		
4070082	T25	ST5.5 x 35	100 St.		
4070083	T25	ST5.5 x 41	100 St.		
4070084	T25	ST5.5 x 47	100 St.		
4070085	T25	ST5.5 x 53	100 St.		
4070086	T25	ST5.5 x 59	100 St.		
4070087	T25	ST5.5 x 65	100 St.		
4070088	T25	ST5.5 x 71	100 St.		
4070028	T25	ST5.5 x 77	100 St.		
4070029	T25	ST5.5 x 83	100 St.		

WICSTYLE 75 evo / 65 evo / 65

Zubehör
Accessories

Verbindungselemente
Connecting components

Artikel Article			VE PU	Bezeichnung Designation	Abbildung Figure
4070110	T10	ST3.5 x 25	100 St.	Senkblechschraube	
4070071	T15	ST3.9 x 9.5	100 St.	ähnlich DIN 7982	
4070067	T15	ST3.9 x 13	100 St.	Stahl rostfrei, A2	
4070057	T15	ST3.9 x 19	100 St.		
4070179	T15	ST3.9 x 22	100 St.	<i>Self-tapping countersunk screw</i>	
4070052	T15	ST3,9 x 25	100 St.	<i>similar DIN 7982</i>	
4070063	T15	ST3.9 x 32	100 St.	<i>Stainless steel, A2</i>	
4070053	T20	ST4.2 x 9.5	100 St.		
4070177	T20	ST4.2 x 11	100 St.		
4070056	T20	ST4.2 x 16	100 St.		
4070042	T20	ST4.2 x 25	100 St.		
4070058	T20	ST4.2 x 38	100 St.		
4070061	T20	ST4.2 x 45	100 St.		
4070054	T20	ST4.2 x 50	100 St.		
4070055	T25	ST4.8 x 13	100 St.		
4070066	T25	ST4.8 x 19	100 St.		
4070115	T25	ST4.8 x 25	100 St.		
4070163	T25	ST4.8 x 32	100 St.		
4070070	T25	ST4.8 x 45	100 St.		
4070443	T25	ST4.8 x 60	100 St.		
4070165	T25	ST4.8 x 78	100 St.		
4070162	T25	ST4.8 x 90	100 St.		
4070164	T25	ST4.8 x 100	100 St.		
4070178	T25	ST4.8 x 110	100 St.		
4070229	T25	ST6.3 x 120	100 St.		

WICSTYLE 75 evo / 65 evo / 65

Zubehör
Accessories

Verbindungselemente
Connecting components

Artikel Article		VE PU	Bezeichnung Designation	Abbildung Figure
4070232	M6 x 20	100 St.	Senkschraube mit Innensechskant	
4070233	M8 x 16	100 St.	DIN 7991	
4070234	M8 x 25	100 St.	Stahl rostfrei, A2	
			<i>Hexagon socket-head countersunk screw DIN 7991 Stainless steel, A2</i>	

WICSTYLE 75 evo / 65 evo / 65

Zubehör
Accessories

Verbindungselemente
Connecting components

Artikel Article		VE PU	Bezeichnung Designation	Abbildung Figure
4070226	M6 x 35	100 St.	Zylinderschraube mit Innensechskant	
4070230	M6 x 50	100 St.	DIN 912	
4070227	M8 x 12	100 St.	Stahl rostfrei, A2	
4070228	M8 x 25	100 St.	<i>Fillister hexagon socket-head screw DIN 912 Stainless steel, A2</i>	

WICSTYLE 75 evo / 65 evo / 65

Zubehör
Accessories

Verbindungselemente
Connecting components

Artikel Article		VE PU	Bezeichnung Designation	Abbildung Figure
4070180	M8 x 45	100 St.	Sechskantschraube	
4070221	M8 x 65	100 St.	DIN 931	
4070222	M8 x 80	100 St.	Stahl rostfrei, A2	
4070223	M8 x 100	100 St.		
4070224	M8 x 130	100 St.	Hexagon head screw DIN 931 Stainless steel, A2	

WICSTYLE 75 evo / 65 evo / 65

Zubehör
Accessories

Verbindungselemente
Connecting components

Artikel Article			VE PU	Bezeichnung Designation	Abbildung Figure
4070244	T25	ST5.5 x 25	100 St.	Blechschaube mit Zylinderkopf	
4070245	T25	ST5.5 x 31	100 St.	Gewinde ähnlich DIN ISO 7049	
4070246	T25	ST5.5 x 37	100 St.	Kopf ähnlich DIN 7984	
4070247	T25	ST5.5 x 43	100 St.	Stahl rostfrei, A4	
4070248	T25	ST5.5 x 49	100 St.	<i>Self-tapping pan-head screw</i>	
4070249	T25	ST5.5 x 55	100 St.	<i>Thread similar DIN ISO 7049</i> <i>head similar DIN 7984</i> <i>Stainless steel, A4</i>	

WICSTYLE 75 evo / 65 evo / 65

Zubehör
Accessories

Verbindungselemente
Connecting components

Artikel Article			VE PU	Bezeichnung Designation	Abbildung Figure
4070240	SW4	ST4.8 x 32	100 St.	Blechschaube mit Zylinderkopf	
4070089	T25	ST5.5 x 23	100 St.	Gewinde ähnlich DIN ISO 7049	
4070090	T25	ST5.5 x 29	100 St.	Kopf ähnlich DIN 912	
4070091	T25	ST5.5 x 35	100 St.	Stahl rostfrei, A4	
4070092	T25	ST5.5 x 41	100 St.	<i>Self-tapping cylinder-head screw</i>	
4070093	T25	ST5.5 x 47	100 St.	<i>Thread similar DIN ISO 7049</i>	
4070094	T25	ST5.5 x 53	100 St.	<i>head similar DIN 912</i>	
4070095	T25	ST5.5 x 59	100 St.	<i>Stainless steel, A4</i>	
4070096	T25	ST5.5 x 65	100 St.		
4070097	T25	ST5.5 x 71	100 St.		

WICSTYLE 75 evo / 65 evo / 65

Zubehör
Accessories

Verbindungselemente
Connecting components

Artikel Article			VE PU	Bezeichnung Designation	Abbildung Figure
4070242	T25	ST4.8 x 25	100 St.	Bohrschraube mit Senkkopf	
4070243	T25	ST4.8 x 32	100 St.	ähnlich DIN ISO 1482 Stahl rostfrei, A2 <i>Countersunk head drilling screw similar DIN ISO 1482 Stainless steel, A2</i>	

WICSTYLE 75 evo / 65 evo / 65





Zubehör
Accessories

Verbindungselemente
Connecting components

Artikel Article			VE PU	Bezeichnung Designation	Abbildung Figure
4970082	T20	ST4.2 x 22	100 St.	Bohrschraube mit Linsenkopf	
4970081	T20	ST4.2 x 40	100 St.	Stahl rostfrei, A2	
4970074	T20	ST4.2 x 45	100 St.	<i>Fillister head drilling screw</i>	
4970086	T20	ST4.2 x 50	100 St.	<i>Stainless steel, A2</i>	
4970087	T20	ST4.2 x 55	100 St.		

	Seite Page
Sägebeilagen <i>Sawing shims</i>	6/3
Schablonen <i>Templates</i>	6/6
Stanzwerkzeuge <i>Punching tools</i>	6/13
Presstawerkzeuge <i>Crimping tools</i>	6/23
Verschiedenes <i>Miscellaneous</i>	6/26
Hilfsstoffe <i>Auxilliary means</i>	6/36
Abdichtungen <i>Sealings</i>	6/41

Sägebeilagen
Sawing shims

Artikel Article	VE PU	Anwendung Application	Bezeichnung / Hinweise Designation / Indications	Abbildung Figure
		Material / Material Farbe / Colour	Zuordnung Assignment	
5050000	1 Paar 1 pair	WICSTYLE 65 WICSTYLE 65evo	Sägebeilage	
		Al	Sawing shim	
			1916001,1916002,1916003,1916004,1916005 1916009,1916019,1916062,1916064,1916067 1916068,1916069,1916073,1916076,1916077 1916201,1916202,1916203,1916204,1916205 1916206,1916207,1916209,1916211,1916213 1916215,1916220,1916224,1916241,1916246 1916247,1916248,1916249,1916250,1916251 1916256,1916258,1916259,1916260,1916301 1916303	
5050297	1 Paar 1 pair	WICSTYLE 75evo	Sägebeilage	
		Al	Sawing shim	
			1020461,1020510,1020511,1020534	
5050298	1 Paar 1 pair	WICSTYLE 75evo	Sägebeilage	
		Al	Sawing shim	
			1020461,1020501,1020502,1020503,1020510 1020511,1020515	
5950001	1 Paar 1 pair	WICSTYLE 65evo	Sägebeilage	
		Al	Sawing shim	
			1916338	

Sägebeilagen
Sawing shims

Artikel Article	VE PU	Anwendung Application	Bezeichnung / Hinweise Designation / Indications	Abbildung Figure
		Material / Material Farbe / Colour	Zuordnung Assignment	
5950004	1 Paar 1 pair	WICSTYLE 75evo	Sägebeilage	
		Al	Sawing shim	
			1020503,1020504,1917001,1917002,1917003 1917004,1917005,1917009,1917062,1917064 1917067,1917068,1917069,1917073,1917076 1917077,1917201,1917202,1917203,1917204 1917205,1917206,1917207,1917209,1917211 1917213,1917215,1917220,1917224,1917241 1917246,1917247,1917248,1917249,1917250 1917251,1917256,1917258,1917259,1917260 1917301,1917303	
5950010	1 Paar 1 pair	WICSTYLE 65evo WICSTYLE 75evo	Sägebeilage	
		Al	Sawing shim	
			1010187,1916336,1917338	
5950011	1 Paar 1 pair	WICSTYLE 75evo	Sägebeilage	
		Al	Sawing shim	
			1010425,1917336	
5950016	1 Paar 1 pair	WICSTYLE 65 WICSTYLE 65evo WICSTYLE 75evo	Sägebeilage	
		Al	Sawing shim	
			1916076,1916077,1917076,1917077,1926506 1926507,1927506,1927507	
5950018	1 Paar 1 pair	WICSTYLE 65evo	Sägebeilage	
		Al	Sawing shim	
			1020499,1020509,1926500,1926501,1926502 1926503,1926504,1926505,1926506,1926507 1926510,1926511,1926512,1926513,1926514 1926515,1926535,1926536	

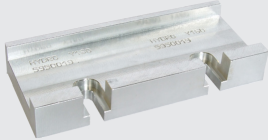
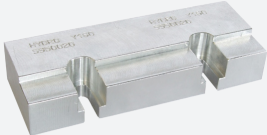
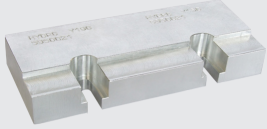

Sägebeilagen
Sawing shims

Artikel Article	VE PU	Anwendung Application	Bezeichnung / Hinweise Designation / Indications	Abbildung Figure
		Material / Material Farbe / Colour	Zuordnung Assignment	
5950019	1 Paar 1 pair	WICSTYLE 75evo	Sägebeilage	
		Al	Sawing shim	
			1020500,1020512,1020513,1020534,1927500 1927501,1927502,1927506,1927507,1927510 1927511,1927512,1927513,1927514,1927515	
5950020	1 Paar 1 pair	WICSTYLE 65evo	Sägebeilage	
		Al	Sawing shim	
			1020509,1926510,1926511,1926512,1926513 1926514,1926515,1926534,1926535,1926536 1926540	
5950021	1 Paar 1 pair	WICSTYLE 75evo	Sägebeilage	
		Al	Sawing shim	
			1927510,1927511,1927512,1927513,1927514 1927515	



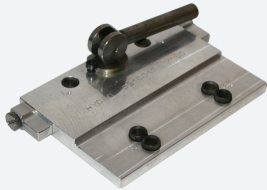
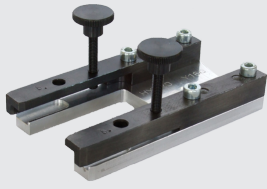

Artikel Article	VE PU	Anwendung Application	Bezeichnung / Hinweise Designation / Indications	Abbildung Figure
		Material / Material Farbe / Colour	Zuordnung Assignment	
5010624	1 St. 1 pcs	WICSTYLE 65evo	Bohrschablone für Entwässerung Blendrahmen, Kämpfer, Flügel. Verwendung mit Tiefenanschlag 5960022.	
			Drill template for drainage frame, transom, sash profiles. Use with bit stop 5960022.	
			1010425	
5910004	1 St. 1 pcs	WICSTYLE 65 WICSTYLE 65evo	Bohrschablone Eck- und Stoßverbindung Blendrahmen	
			Drill template Corner and frame butt-joint connection	
			1010187,1916001,1916002,1916003,1916004 1916005,1916055,1916056,1916057,1916058 1916059,1916060,1916062,1916064,1916067 1916068,1916069,1916073,1916201,1916202 1916203,1916204,1916205,1916206,1916207 1916209,1916211,1916213,1916215,1916220 1916224,1916241,1916244,1916246,1916247 1916248,1916249,1916250,1916251,1916256 1916258,1916259,1916260,1916270,1916271 1916272,1916273,1917203,1926500,1926501 1926502,1926503,1926517,1926518,1926527 1926528,1926541,1926542	
5910006	1 St. 1 pcs	WICSTYLE 75evo	Bohrschablone Eck- und Stoßverbindung Blendrahmen	
			Drill template corner and butt-joint connection of frame	
			1010425,1020502,1020503,1020504,1020508 1917001,1917002,1917003,1917004,1917005 1917055,1917056,1917057,1917058,1917059 1917060,1917062,1917064,1917067,1917068 1917069,1917073,1917201,1917202,1917203 1917204,1917205,1917206,1917207,1917209 1917211,1917213,1917215,1917220,1917224 1917241,1917244,1917246,1917247,1917248 1917249,1917250,1917251,1917256,1917258 1917259,1917260,1917270,1917271,1917272 1917273,1927500,1927501,1927502,1927516 1927517,1927518,1927527,1927528	



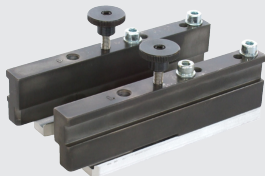

Schablonen Templates

Artikel Article	VE PU	Anwendung Application	Bezeichnung / Hinweise Designation / Indications	Abbildung Figure
		Material / Material Farbe / Colour	Zuordnung Assignment	
5910008	1 St. 1 pcs	WICSTYLE 65evo	Bohrschablone Stoßverbindung Sprosse Klassik-Design (Außenschale)	
		WICSTYLE 75evo	Drill template Butt-joint connection of Classic design glazing bar (outer profile shell)	
			1916338,1917338	
5910009	1 St. 1 pcs	WICSTYLE 65evo	Bohrschablone Bohrungen zum Setzen von Stoßverbinder Sprosse	
		WICSTYLE 75evo	Drill template Drillings for fixing butt-joint connectors glazing bar	
			1916336,1916338,1917336,1917338	
5910010	1 St. 1 pcs	WICSTYLE 65	Bohrschablone Variable Eckverbindung vertikal	
		WICSTYLE 65evo	Drill template Variable vertical corner connection	
		WICSTYLE 75evo	1010187,1010425,1916001,1916002,1916003 1916004,1916055,1916056,1916057,1916058 1916064,1916068,1916069,1916073,1916201 1916202,1916203,1916204,1916241,1916244 1916246,1916247,1916248,1917001,1917002 1917003,1917004,1917055,1917056,1917057 1917058,1917064,1917068,1917069,1917073 1917201,1917202,1917203,1917204,1917241 1917244,1917246,1917247,1917248	
5910011	1 St. 1 pcs	WICSTYLE 65evo	Bohrschablone Variable Stoßverbindung	
		WICSTYLE 75evo	Drill template Variable butt-joint connection	
			1010187,1010425,1916001,1916002,1916003 1916004,1916055,1916056,1916057,1916058 1916064,1916068,1916069,1916073,1916201 1916202,1916203,1916204,1916241,1916244 1916246,1916247,1916248,1917001,1917002 1917003,1917004,1917055,1917056,1917057 1917058,1917064,1917068,1917069,1917073 1917201,1917202,1917203,1917204,1917241 1917244,1917246,1917247,1917248	



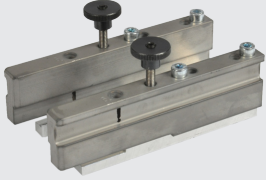

Artikel Article	VE PU	Anwendung Application	Bezeichnung / Hinweise Designation / Indications	Abbildung Figure
		Material / Material Farbe / Colour	Zuordnung Assignment	
5910012	1 St. 1 pcs	WICSTYLE 65evo	Bohrschablone Variable Eckverbindung horizontal	
		WICSTYLE 75evo	Drill template Variable horizontal corner connection	
			1010187,1010425,1916001,1916002,1916003 1916004,1916055,1916056,1916057,1916058 1916062,1916064,1916068,1916069,1916073 1916201,1916202,1916203,1916204,1916241 1916244,1916246,1916247,1916248,1916256 1916258,1916259,1916260,1917001,1917002 1917003,1917004,1917055,1917056,1917057 1917058,1917062,1917064,1917068,1917069 1917073,1917201,1917202,1917203,1917204 1917241,1917244,1917246,1917247,1917248 1917256,1917258,1917259,1917260	
5910013	1 St. 1 pcs	WICSTYLE 65evo	Bohrschablone Eckverbindung Blendrahmen Klassik-Design	
		WICSTYLE 75evo	Drill template Corner connection Classic design frame profile	
			1916009,1917009	
5910014	1 St. 1 pcs	WICSTYLE 65	Bohrschablone Eckverbindung Blendrahmen mit BTC-Nut	
		WICSTYLE 65evo	Drill template BTC-groove frames corner connection	
			1916019,1926504,1926505	
5910016	1 St. 1 pcs	WICSTYLE 65	Bohrschablone Eckverbindung Einspannblendrahmen	
		WICSTYLE 65evo	Drill template Corner connection of clamping frame profile	
		WICSTYLE 75evo	1020512,1020513,1916076,1916077,1917076 1917077,1926506,1926507,1927506,1927507	

Schablonen Templates



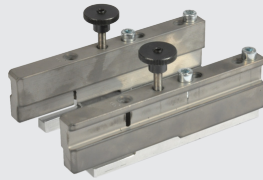



Artikel Article	VE PU	Anwendung Application	Bezeichnung / Hinweise Designation / Indications	Abbildung Figure
		Material / Material Farbe / Colour	Zuordnung Assignment	
5910019	1 St. 1 pcs	WICSTYLE 65evo	Bohrschablone Stoßverbindung Kämpfer und Sprossen, Eckverbindung Türflügel als Blendrahmen	
		WICSTYLE 75evo	Drill template Butt-joint connection of transom and glazing bar profiles, corner connection of door leaf as frame	
			1020499,1020509,1916336,1916338,1917338 1926510,1926511,1926512,1926513,1926514 1926515,1926535,1926536,1926544	
5910020	1 St. 1 pcs	WICSTYLE 75evo	Bohrschablone Stoßverbindung Kämpfer und Sprossen, Eckverbindung Türflügel als Blendrahmen	
			Drill template Butt-joint connection of transom and glazing bar profiles, corner connection of door leaf as frame	
			1020500,1917336,1927510,1927511,1927512 1927513,1927514,1927515	
5910023	1 St. 1 pcs	WICSTYLE 65	Bohrschablone Eckverbindung Flügel	
		WICSTYLE 65evo	Drill template Corner connection sash	
			1020509,1926510,1926511,1926512,1926513 1926514,1926515,1926534,1926535,1926536 1926540	
5910024	1 St. 1 pcs	WICSTYLE 75evo	Bohrschablone Eckverbindung Flügel	
			Drill template Corner connection sash	
			1020461,1020510,1020511,1020534,1927510 1927511,1927512,1927513,1927514,1927515	
5010592	1 St. 1 pcs	WICSTYLE 65evo	Bohrschablone für Riegelschaltkontakt	
		WICSTYLE 75evo	Drill template for lock switch contact	



Artikel Article	VE PU	Anwendung Application	Bezeichnung / Hinweise Designation / Indications	Abbildung Figure
		Material / Material Farbe / Colour	Zuordnung Assignment	
5910058	1 St. 1 pcs	WICSTYLE 65evo WICSTYLE 75evo	Bohrschablone für „Türband 4“ 2-teilig ein- und auswärts Befestigung mit Ankerschraube Bohrabstand 65 mm und 91,5 mm	
			Drill template for „Door hinge 4“ 2 pieces inwards and outwards fastening with anchor screw drilling distance 65 mm and 91,5 mm	
5910059	1 St. 1 pcs	WICSTYLE 65evo WICSTYLE 75evo	Bohrschablone für „Türband 4“ 3-teilig ein- und auswärts Befestigung mit Ankerschraube Bohrabstand 65 mm und 91,5 mm	
			Drill template for „Door hinge 4“ 3 pieces inwards and outwards fastening with anchor screw drilling distance 65 mm and 91.5 mm	
5910060	1 St. 1 pcs	WICSTYLE 65evo WICSTYLE 75evo	Distanzklötze 6 mm für Bohrschablone 5910058/5910059 1 Satz	
			Distance log 6 mm for drill template 5910058/5910059 one kit	
5910074	1 St. 1 pcs	WICSTYLE 65 WICSTYLE 65evo	Bohrschablone für Entwässerung für Türschwelle	
			Drill template for drainage for threshold	
			1926547	
5910076	1 St. 1 pcs	WICSTYLE 65evo	Bohrschablone Eckverbindung Flügel	
			Drill Template Corner connection sash	
			1320034,1920512,1920516	

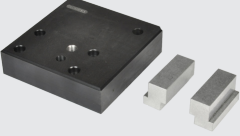

Schablonen Templates

Artikel Article	VE PU	Anwendung Application	Bezeichnung / Hinweise Designation / Indications	Abbildung Figure
		Material / Material Farbe / Colour	Zuordnung Assignment	
5910077	1 St. 1 pcs	WICSTYLE 75evo	Bohrschablone Eckverbindung Flügel	
			Drill template Corner connection sash	
			1020501,1020515,1020533,1320033,1920513 1920517	
5910081	1 St. 1 pcs	WICSTYLE 65evo	Bohrschablone für Befestigung Klemmprofil 4980067	
		WICSTYLE 75evo	Durchschusshemmung	
			Drill template for fixing clamping profile 4980067 Bullet-resistance	
5910086	1 St. 1 pcs	WICSTYLE 65evo	Bohrschablone für „Türband 4“ 3-teilig für Fingerschutztür	
			Befestigung mit Ankerschraube	
			Bohrabstand 109,5 mm Drill template „Door hinge 4“ 3 pieces for doors with finger protection gaskets fastening with anchor screw drilling distance 109,5 mm	
5910087	1 St. 1 pcs	WICSTYLE 65evo	Bohrschablone für „Türband 4“ 3-teilig für Durchschußhemmung	
		WICSTYLE 75evo	Befestigung mit Ankerschraube	
			Bohrabstand 86 mm Drill template „Door hinge 4“ 3 pieces for doors with bullet resistant fastening with anchor screw drilling distance 86 mm	
5910088	1 St. 1 pcs	WICSTYLE 65evo	Bohrschablone für „Türband 4“ 2-teilig für Eckpfostenbänder	
		WICSTYLE 75evo	Drill template „Door hinge 4“ 2 pieces for corner mullion door hinges	
		sans untreated		

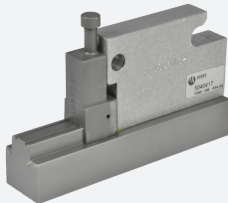
Artikel Article	VE PU	Anwendung Application	Bezeichnung / Hinweise Designation / Indications	Abbildung Figure
		Material / Material Farbe / Colour	Zuordnung Assignment	
5910089	1 St. 1 pcs	WICSTYLE 65evo	Bohrschablone für „Türband 4“ 3-teilig für Eckpfostenbänder	
		WICSTYLE 75evo		
		sans <i>untreated</i>		
5910090	1 St. 1 pcs	WICSTYLE 65evo	Distanzklötze 5 mm für Bohrschablone 5910087 1 Satz	
		WICSTYLE 75evo		



Artikel Article	VE PU	Anwendung Application	Bezeichnung / Hinweise Designation / Indications	Abbildung Figure
		Material / Material Farbe / Colour	Zuordnung Assignment	
5040000	1 St. 1 pcs	WICSTYLE 65evo WICSTYLE 75evo	Multifunktionsstanzwerkzeug bestehend aus Pneumatikpresse und Werkzeugaufnahme	
			Multi-functional punching tool consisting of pneumatic press and tool carrier	
5040003	1 St. 1 pcs	WICSTYLE 65evo WICSTYLE 75evo	Arbeitsstisch für Multifunktionsstanzwerkzeug	
			Work bench for multi-functional punching tool	
5040004	1 St. 1 pcs	WICSTYLE 65evo WICSTYLE 75evo	Längenanschlag zum Anbau an das Multifunktionsstanzwerkzeug	
			Length limiter for fitting on multi-functional punching tool	
5040005	1 St. 1 pcs	WICSTYLE 65evo WICSTYLE 75evo	Wartungseinheit für Multifunktionsstanze	
			Maintenance unit for multi-functional punching tool	
5040388	1 St. 1 pcs	WICSTYLE 65evo WICSTYLE 75evo	Adapter für Werkzeugaufnahme von 5040000 zur Verwendung von 5940013 in Station 2	
			Adapter for tool carrier for 5040000 for usage of 5940013 in station 2	
		sans <i>untreated</i>		
5040407	1 St. 1 pcs	WICSTYLE 65evo	Wechselwerkzeug für 5040000 Stanzung in Adapterprofil 22 mm	
			Interchangeable tool for 5040000 Punch in adapter profile 22 mm	
			4930049,4930052,4930089,4930090,4930100 4930101	



Artikel Article	VE PU	Anwendung Application	Bezeichnung / Hinweise Designation / Indications	Abbildung Figure
		Material / Material Farbe / Colour	Zuordnung Assignment	
5040408	1 St. 1 pcs	WICSTYLE 65evo	Umrüstsatz für Wechselwerkzeug 5040017 für 5040000 Stanzung in Adapterprofil 24 mm	
			Conversion set of interchangeable tool 5040017 for 5040000 Punch in adapter profile 24 mm	
			4930050,4930053	
5040417	1 St. 1 pcs	WICSTYLE 65evo	Wechselwerkzeug für 5040101 Wechselwerkzeug zum Schieberstangenkanal öffnen	
			Interchangeable tool for 5040101 Interchangeable tool to open slide rod channel	
			1020461,1020501,1020509,1020510,1020511 1020515,1020533,1020534,1320033,1320034 1920512,1920513,1920516,1920517,1926510 1926511,1926512,1926513,1926514,1926515 1926535,1926536,1926540,1927510,1927511 1927512,1927513,1927514,1927515	
5940001	1 St. 1 pcs	WICSTYLE 65 WICSTYLE 65evo WICSTYLE 75evo	Wechselwerkzeug für 5040000 Eck- und Stoßverbindung Blendrahmen	
			Interchangeable tool for 5040000 Corner and butt-joint connection of frame profile	
			1010187,1010425,1020502,1020503,1020504 1020508,1916001,1916002,1916003,1916004 1916005,1916009,1916019,1916055,1916059 1916060,1916064,1916067,1916068,1916069 1916073,1916201,1916202,1916203,1916204 1916205,1916206,1916207,1916209,1916211 1916213,1916215,1916220,1916224,1916241 1916244,1916246,1916247,1916248,1916249 1916250,1916251,1916270,1916271,1916272 1916273,1917001,1917002,1917003,1917004 1917005,1917055,1917056,1917057,1917058 1917059,1917060,1917064,1917067,1917068 1917069,1917073,1917201,1917202,1917203 1917204,1917205,1917206,1917207,1917209 1917211,1917213,1917215,1917220,1917224 1917241,1917244,1917246,1917247,1917248 1917249,1917250,1917251,1917270,1917271 1917272,1917273,1926500,1926501,1926502 1926503,1926504,1926505,1926516,1926517 1926518,1926527,1926528,1926541,1926542 1927500,1927501,1927502,1927516,1927517 1927518,1927527,1927528	

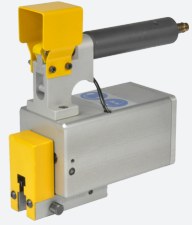

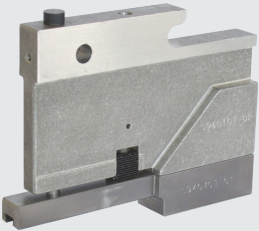
Artikel Article	VE PU	Anwendung Application	Bezeichnung / Hinweise Designation / Indications	Abbildung Figure
		Material / Material Farbe / Colour	Zuordnung Assignment	
5940005	1 St. 1 pcs	WICSTYLE 65evo WICSTYLE 75evo	Wechselwerkzeug für 5040000 Stoßverbindung Sprosse Klassik-Design (Außenschale)	
			Interchangeable tool for 5040000 Butt-joint connection of Classic design glazing bar profiles (outer profile shell)	
			1916338,1917338	
5940006	1 St. 1 pcs	WICSTYLE 65 WICSTYLE 65evo WICSTYLE 75evo	Wechselwerkzeug für 5040000 Dampfdruckausgleich und Entwässerung Blendrahmen	
			Interchangeable tool for 5040000 Vapour pressure equalization and drainage of frame	
			1916001,1916002,1916003,1916004,1916005 1916019,1916062,1916064,1916067,1916068 1916069,1916073,1916076,1916077,1916201 1916202,1916203,1916204,1916205,1916206 1916207,1916209,1916211,1916213,1916215 1916220,1916224,1917001,1917002,1917003 1917004,1917005,1917062,1917064,1917067 1917068,1917069,1917073,1917076,1917077 1917201,1917202,1917203,1917204,1917205 1917206,1917207,1917209,1917211,1917213 1917215,1917220,1917224	
5940007	1 St. 1 pcs	WICSTYLE 65evo WICSTYLE 75evo	Umrüstsatz für Wechselwerkzeug 5040017 für 5040000 Dampfdruckausgleich und Entwässerung Blendrahmen	
			Conversion set of interchangeable tool 5040017 for 5040000 Vapour pressure equalization and drainage of frame	
			1916001,1916002,1916003,1916004,1916005 1916019,1916062,1916064,1916067,1916068 1916069,1916073,1916076,1916077,1916201 1916202,1916203,1916204,1916205,1916206 1916207,1916209,1916211,1916213,1916215 1916220,1916224,1917001,1917002,1917003 1917004,1917005,1917062,1917064,1917067 1917068,1917069,1917073,1917076,1917077 1917201,1917202,1917203,1917204,1917205 1917206,1917207,1917209,1917211,1917213 1917215,1917220,1917224	

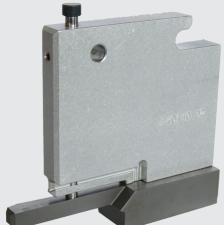
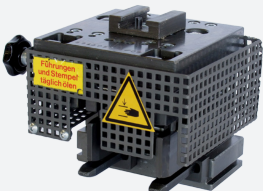

Artikel Article	VE PU	Anwendung Application	Bezeichnung / Hinweise Designation / Indications	Abbildung Figure
		Material / Material Farbe / Colour	Zuordnung Assignment	
5940010	1 St. 1 pcs	WICSTYLE 65 WICSTYLE 65evo WICSTYLE 75evo	Wechselwerkzeug für 5040000 Eckverbindung Einspannblendrahmen	
			Interchangeable tool for 5040000 Corner connection of clamping frame profile	
			1020512,1020513,1916076,1916077,1917076 1917077,1926506,1926507,1927506,1927507	
5940013	1 St. 1 pcs	WICSTYLE 65evo WICSTYLE 75evo	Wechselwerkzeug für 5040000 Eckverbindung Flügel	
			Interchangeable tool for 5040000 Corner connection sash	
			1020461,1020509,1020510,1020511,1020534 1926510,1926511,1926512,1926513,1926514 1926515,1926534,1926535,1926536,1926540 1927510,1927511,1927512,1927513,1927514 1927515	
5940035	1 St. 1 pcs	WICSTYLE 65evo WICSTYLE 75evo	Wechselwerkzeug für 5040000 Stanzung für verdeckte Entwässerung Blendrahmen	
			Interchangeable tool for 5040000 Punching for concealed drainage of frame profile	
5940049	1 St. 1 pcs	WICSTYLE 65 WICSTYLE 65evo WICSTYLE 75evo	Wechselwerkzeug für 5040000 Eckverbindung Flügel als Flügel und Flügel als Blendrahmen	
			Interchangeable tool for 5040000 Corner connection sash as sash and sash as frame	
			1020499,1020500,1020509,1926510,1926511 1926512,1926513,1926514,1926515,1926534 1926535,1926536,1926540,1927510,1927511 1927512,1927513,1927514,1927515	
5940072	1 St. 1 pcs	WICSTYLE 65 WICSTYLE 65evo	Wechselwerkzeug für 5040000 Stanzung für Polyamid-Schieberstange 4930086	
			Interchangeable tool for 5040000 Punching for polyamide slide rod 4930086	
			4930086	

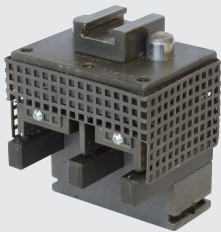
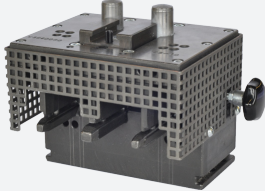

Artikel Article	VE PU	Anwendung Application	Bezeichnung / Hinweise Designation / Indications	Abbildung Figure
		Material / Material Farbe / Colour	Zuordnung Assignment	
5040090	1 St. 1 pcs	WICSTYLE 65evo	Handstanzwerkzeug für Entwässerung für Blendrahmen- & Kämpferprofile	
		WICSTYLE 75evo	Hand punching tool for drainage for frame and transom profiles	
			1916001,1916002,1916003,1916004,1916005 1916019,1916062,1916064,1916067,1916068 1916069,1916073,1916076,1916077,1916201 1916202,1916203,1916204,1916205,1916206 1916207,1916209,1916211,1916213,1916215 1916220,1916224,1916241,1916256,1916301 1917001,1917002,1917003,1917004,1917005 1917062,1917064,1917067,1917068,1917069 1917073,1917076,1917077,1917201,1917202 1917203,1917204,1917205,1917206,1917207 1917209,1917211,1917213,1917215,1917220 1917224,1917241,1917256,1917301	
5040101	1 St. 1 pcs	WICSTYLE 65evo	Handstanzgrundkörper zur Bestückung mit Wechselwerkzeugen Pneumatische Handstanze für Wechselwerkzeuge	
		WICSTYLE 75evo	Hand punching tool For interchangeable tools	

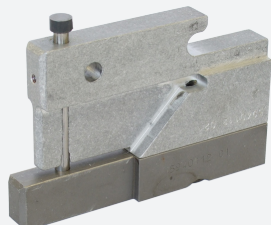

Artikel Article	VE PU	Anwendung Application	Bezeichnung / Hinweise Designation / Indications	Abbildung Figure
		Material / Material Farbe / Colour	Zuordnung Assignment	
5940101	1 St. 1 pcs	WICSTYLE 65 WICSTYLE 65evo WICSTYLE 75evo	Wechselwerkzeug für 5040101 Eck- und Stoßverbindung Blendrahmen	
			Interchangeable tool for 5040101 Frame and transom connection	
			1010187,1010425,1020502,1020503,1020504 1020508,1916001,1916002,1916003,1916004 1916005,1916009,1916055,1916059,1916060 1916064,1916067,1916068,1916069,1916073 1916076,1916077,1916201,1916202,1916203 1916204,1916205,1916206,1916207,1916209 1916211,1916213,1916215,1916220,1916224 1916241,1916244,1916246,1916247,1916248 1916249,1916250,1916251,1916270,1916271 1916272,1916273,1916301,1916303,1917001 1917002,1917003,1917004,1917005,1917009 1917055,1917056,1917057,1917058,1917059 1917060,1917064,1917067,1917068,1917069 1917073,1917076,1917077,1917201,1917202 1917203,1917204,1917205,1917206,1917207 1917209,1917211,1917213,1917215,1917220 1917224,1917241,1917244,1917246,1917247 1917248,1917249,1917250,1917251,1917270 1917271,1917272,1917273,1917301,1917303 1926500,1926501,1926502,1926503,1926506 1926507,1926516,1926517,1926518,1926527 1926528,1926541,1926542,1927500,1927501 1927502,1927506,1927507,1927516,1927517 1927518,1927527,1927528	
5940107	1 St. 1 pcs	WICSTYLE 65 WICSTYLE 65evo WICSTYLE 75evo	Wechselwerkzeug für 5040101 inkl. 2x Adapter Eckverbindung Einspannblendrahmen ohne Adapter: Außenschale Adapter 13,3 mm: Innenschale Adapter 17,3 mm: Innenschale Einspannblendrahmen für Senk-Klapp-Flügel	
			Interchangeable tool for 5040101 incl. 2x adapter Corner connection of clamping frame without adapter: outer profile shell adapter 13,3 mm: inner profile shell adapter 17,3 mm: inner profile shell clamping frame for top hung sash	
			1020501,1020512,1020513,1020515,1020533 1320033,1320034,1916076,1916077,1917076 1917077,1920512,1920513,1920516,1920517 1926506,1926507,1927506,1927507	

Artikel Article	VE PU	Anwendung Application	Bezeichnung / Hinweise Designation / Indications	Abbildung Figure
		Material / Material Farbe / Colour	Zuordnung Assignment	
5940110	1 St. 1 pcs	WICSTYLE 75evo	Wechselwerkzeug für 5040101 Eckverbindung verdeckter Flügel (Außenschale) und verdeckter Stulpflügel (Außenschale)	
			Interchangeable tool for 5040101 Corner connection of concealed sash (outer profile shell) and double casement concealed sash profile (outer profile shell)	
			1020499,1020500	
5940051	1 St. 1 pcs	WICSTYLE 65evo WICSTYLE 75evo	Einzelstanzwerkzeug Eck- und Stoßverbindung Blendrahmen	
			Single punching tool Corner and butt-joint connection of frame	
			1020502,1020503,1020504,1020508,1916001 1916002,1916003,1916004,1916005,1916009 1916055,1916056,1916057,1916058,1916059 1916060,1916062,1916064,1916067,1916068 1916069,1916073,1916201,1916202,1916203 1916204,1916205,1916206,1916207,1916209 1916211,1916213,1916215,1916220,1916224 1916241,1916244,1916246,1916247,1916248 1916249,1916250,1916251,1916256,1916258 1916259,1916260,1916270,1916271,1916272 1916273,1917001,1917002,1917003,1917004 1917005,1917055,1917056,1917057,1917058 1917059,1917060,1917062,1917064,1917067 1917068,1917069,1917073,1917201,1917202 1917203,1917204,1917205,1917206,1917207 1917209,1917211,1917213,1917215,1917220 1917224,1917241,1917244,1917246,1917247 1917248,1917249,1917250,1917251,1917256 1917258,1917259,1917260,1917270,1917271 1917272,1917273,1926500,1926501,1926502 1926503,1926516,1926517,1926518,1926527 1926528,1926541,1926542,1927500,1927501 1927502,1927516,1927517,1927518,1927527 1927528	
	Einzelstanzwerkzeug Stoßverbindung Sprosse Klassik-Design (Außenschale)			
	Single punching tool Butt-joint connection of Classic design glazing bar (outer profile shell)			
			1916338,1917338	

Artikel Article	VE PU	Anwendung Application	Bezeichnung / Hinweise Designation / Indications	Abbildung Figure
		Material / Material Farbe / Colour	Zuordnung Assignment	
5940054	1 St. 1 pcs	WICSTYLE 65evo	Einzelstanzwerkzeug Eckverbindung Türflügel	
		WICSTYLE 75evo	Single punching tool Corner connection door sash	
			1020461,1020509,1020510,1020511,1020534 1926510,1926511,1926512,1926513,1926514 1926515,1926534,1926535,1926536,1926540 1927510,1927511,1927512,1927513,1927514 1927515	
5940060	1 St. 1 pcs	WICSTYLE 65evo	Einzelstanzwerkzeug Eckverbindung Einspannblendrahmen	
		WICSTYLE 75evo	Single punching tool Corner connection of clamping frame profile	
			1020512,1020513,1916076,1916077,1917076 1917077,1926506,1926507,1927506,1927507	
5940062	1 St. 1 pcs	WICSTYLE 65evo	Umrüstsatz für Einzelstanzwerkzeug 5040052 Dampfdruckausgleich und Entwässerung Blendrahmen	
		WICSTYLE 75evo	Conversion set for single punching tool 5040052 Vapour pressure equalization and drainage of frame	
			1916001,1916002,1916003,1916004,1916005 1916019,1916062,1916064,1916067,1916068 1916069,1916073,1916076,1916077,1916201 1916202,1916203,1916204,1916205,1916206 1916207,1916209,1916211,1916213,1916215 1916220,1916224,1917001,1917002,1917003 1917004,1917005,1917062,1917064,1917067 1917068,1917069,1917073,1917076,1917077 1917201,1917202,1917203,1917204,1917205 1917206,1917207,1917209,1917211,1917213 1917215,1917220,1917224	

Artikel Article	VE PU	Anwendung Application	Bezeichnung / Hinweise Designation / Indications	Abbildung Figure
		Material / Material Farbe / Colour	Zuordnung Assignment	
5940069	1 St. 1 pcs	WICSTYLE 65evo WICSTYLE 75evo	Einzelstanzwerkzeug Dampfdruckausgleich und Entwässerung Blendrahmen	
			Single punching tool Vapour pressure equalization and drainage of frame	
			1916001,1916002,1916003,1916004,1916005 1916019,1916062,1916064,1916067,1916068 1916069,1916073,1916076,1916077,1916201 1916202,1916203,1916204,1916205,1916206 1916207,1916209,1916211,1916213,1916215 1916220,1916224,1917001,1917002,1917003 1917004,1917005,1917062,1917064,1917067 1917068,1917069,1917073,1917076,1917077 1917201,1917202,1917203,1917204,1917205 1917206,1917207,1917209,1917211,1917213 1917215,1917220,1917224	
5940112	1 St. 1 pcs	WICSTYLE 65 WICSTYLE 65evo WICSTYLE 75evo	Wechselwerkzeug für 5040101 Eckverbindung Flügel	
			Interchangable tool for 5040101 Corner connection sash	
			1020461,1020501,1020509,1020510,1020511 1020515,1020533,1020534,1320033,1320034 1920516,1920517,1926510,1926511,1926512 1926513,1926514,1926515,1926534,1926535 1926536,1926540,1927510,1927511,1927512 1927513,1927514,1927515	
5040150	1 St. 1 pcs	WICSTYLE 65evo WICSTYLE 75evo	Dichtungsstanze pneumatisch zum Ablängen von Dichtungsprofilen	
			Pneumatic gasket punch for cutting gasket profiles to length	
5040151	1 St. 1 pcs	WICSTYLE 65evo WICSTYLE 75evo	Arbeitstisch für Dichtungsstanze 5040150	
			Work bench for gasket punch 5040150	

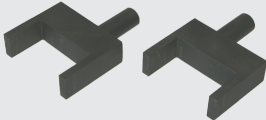
Artikel Article	VE PU	Anwendung Application	Bezeichnung / Hinweise Designation / Indications	Abbildung Figure
		Material / Material Farbe / Colour	Zuordnung Assignment	
5040152	1 St. 1 pcs	WICSTYLE 65evo	Längenanschlag für Dichtungsstanze 5040150	
		WICSTYLE 75evo	Length limiter for gasket punch 5040150	
5040166	1 St. 1 pcs	WICSTYLE 65evo	Ersatz-Schneidplatte für 90°-Schnitt für Dichtungsstanze 5040150	
		WICSTYLE 75evo	Replacement cutting plate for 90° cut for gasket punch 5040150	

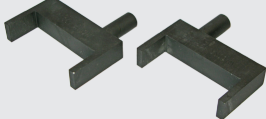
Artikel Article	VE PU	Anwendung Application	Bezeichnung / Hinweise Designation / Indications	Abbildung Figure
		Material / Material Farbe / Colour	Zuordnung Assignment	
5930001	1 Paar 1 pair	WICSTYLE 65 WICSTYLE 65evo WICSTYLE 75evo	Presstwerkzeug-Satz	
		Stahl Steel	Crimping tool set	
			1010187,1020499,1020509,1916001,1916002 1916003,1916004,1916005,1916055,1916056 1916057,1916058,1916059,1916060,1916062 1916064,1916067,1916068,1916069,1916073 1916201,1916202,1916203,1916204,1916205 1916206,1916207,1916241,1916244,1916246 1916247,1916248,1916249,1916250,1916251 1916256,1916258,1916259,1916260,1916301 1916303,1926500,1926501,1926502,1926503 1926510,1926511,1926512,1926513,1926514 1926515,1926534,1926535,1926536,1926540 1926541,1926542	
5930003	1 Paar 1 pair	WICSTYLE 65evo WICSTYLE 75evo	Presstwerkzeug-Satz	
		Stahl Steel	Crimping tool set	
			1020461,1020500,1020502,1020503,1020504 1020510,1020511,1020534,1916009,1917001 1917002,1917003,1917004,1917005,1917055 1917056,1917057,1917058,1917059,1917060 1917062,1917064,1917067,1917068,1917069 1917073,1917201,1917202,1917203,1917204 1917205,1917206,1917207,1917241,1917244 1917246,1917247,1917248,1917249,1917250 1917251,1917256,1917258,1917259,1917260 1917301,1917303,1927500,1927501,1927502 1927510,1927511,1927512,1927513,1927514 1927515	
5930005	1 Paar 1 pair	WICSTYLE 75evo	Presstwerkzeug-Satz	
		Stahl Steel	Crimping tool set	
			1917009	

Artikel Article	VE PU	Anwendung Application	Bezeichnung / Hinweise Designation / Indications	Abbildung Figure
		Material / Material Farbe / Colour	Zuordnung Assignment	
5930008	1 Paar 1 pair	WICSTYLE 65 WICSTYLE 65evo	Presstawerkzeug-Satz für Einspannblendrahmen	
		Stahl Steel	Crimping tool set for clamping frame	
			1916076,1916077,1926506,1926507	
5930010	1 Paar 1 pair	WICSTYLE 75evo	Presstawerkzeug-Satz	
		Stahl Steel	Crimping tool set	
			1917076,1917077,1927506,1927507	
5930030	1 Paar 1 pair	WICSTYLE 65evo	Presstawerkzeug-Satz	
			Crimping tool set	
			1320034,1920512,1920516	
5930031	1 Paar 1 pair	WICSTYLE 75evo	Presstawerkzeug-Satz	
			Crimping tool set	
			1020501,1020515,1020533,1320033,1920513 1920517	
5030100	1 Paar 1 pair	WICSTYLE 65evo WICSTYLE 75evo	Messeradapter für Pressta Eisele PV10	
		Stahl Steel	Knife adaptor for Eisele PV10 crimping tool	
5030101	1 Paar 1 pair	WICSTYLE 65evo WICSTYLE 75evo	Messeradapter für Elumatec EP124	
		Stahl Steel	Knife adaptor for Elumatec EP124	

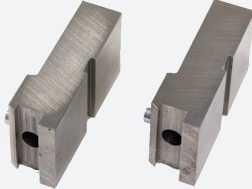
Artikel Article	VE PU	Anwendung Application	Bezeichnung / Hinweise Designation / Indications	Abbildung Figure
		Material / Material Farbe / Colour	Zuordnung Assignment	
5030102	1 Paar 1 pair	WICSTYLE 65evo	Messeradapter für Loth Uniprä 250	
		WICSTYLE 75evo	Knife adaptor for Loth Uniprä 250	
		Stahl Steel		
5030103	1 Paar 1 pair	WICSTYLE 65evo	Messeradapter für Rapid HP205 / HP208	
		WICSTYLE 75evo	Knife adaptor for Rapid HP 205 / HP 208	
		Stahl Steel		





Verschiedenes
Miscellaneous

Artikel Article	VE PU	Anwendung Application	Bezeichnung / Hinweise Designation / Indications	Abbildung Figure
		Material / Material Farbe / Colour	Zuordnung Assignment	
5060001	1 St. 1 pcs	WICSTYLE 65evo	Tiefenanschlag für Bohrer Ø8 mm	
		WICSTYLE 75evo	Bit stop for Ø8 mm drill	
5060002	1 St. 1 pcs	WICSTYLE 65evo	Kegelsenker 80° Ø8 mm	
		WICSTYLE 75evo	Countersink 80°, Ø8 mm	
5060003	1 St. 1 pcs	WICSTYLE 65evo	Kegelsenker 80° Ø10 mm	
		WICSTYLE 75evo	Countersink 80°, Ø10 mm	
5060004	1 St. 1 pcs	WICSTYLE 65evo	Kegelsenker 80° Ø13.4 mm	
		WICSTYLE 75evo	Countersink 80°, Ø13.4 mm	
5060012	1 St. 1 pcs	WICSTYLE 65evo	Bithalter Längsgriff	
		WICSTYLE 75evo	mit Bitverriegelung	
			Bit holder with longitudinal handle with bit lock	
5060013	5 St. 5 pcs	WICSTYLE 65evo	Schraubenbit T8	
		WICSTYLE 75evo	Länge 70 mm	
			Screwdriver bit T8 Length 70 mm	





Verschiedenes
Miscellaneous

Artikel Article	VE PU	Anwendung Application	Bezeichnung / Hinweise Designation / Indications	Abbildung Figure
		Material / Material Farbe / Colour	Zuordnung Assignment	
5060014	5 St. 5 pcs	WICSTYLE 65evo	Schraubenbit T10 Länge 70 mm	
		WICSTYLE 75evo	Screwdriver bit T10 Length 70 mm	
5060015	5 St. 5 pcs	WICSTYLE 65evo	Schraubenbit T15 Länge 70 mm	
		WICSTYLE 75evo	Screwdriver bit T15 Length 70 mm	
5960012	5 St. 5 pcs	WICSTYLE 65evo	Schraubenbit T15 Länge 50 mm, mit Haltefunktion	
		WICSTYLE 75evo	Screwdriver bit T15 Length 50 mm, with retaining function	
5060016	5 St. 5 pcs	WICSTYLE 65evo	Schraubenbit T20 Länge 70 mm	
		WICSTYLE 75evo	Screwdriver bit T20 Length 70 mm	
5960013	5 St. 5 pcs	WICSTYLE 65evo	Schraubenbit T20 Länge 50 mm, mit Haltefunktion	
		WICSTYLE 75evo	Screwdriver bit T20 Length 50 mm, with retaining function	
5060017	5 St. 5 pcs	WICSTYLE 65evo	Schraubenbit T25 Länge 70 mm	
		WICSTYLE 75evo	Screwdriver bit T25 Length 70 mm	





Verschiedenes
Miscellaneous

Artikel Article	VE PU	Anwendung Application	Bezeichnung / Hinweise Designation / Indications	Abbildung Figure
		Material / Material Farbe / Colour	Zuordnung Assignment	
5060369	5 St. 5 pcs	WICSTYLE 65evo	Schraubenbit T25 Länge 50 mm, mit Haltefunktion	
		WICSTYLE 75evo	Screwdriver bit T25 Length 50 mm, with retaining function	
5060020	1 St. 1 pcs	WICSTYLE 65evo	Formfräser rechtsschneidend Außen Ø: 200 mm, Bohrung Ø: 40 mm, Zähnezahl: 12, Winkel: 60°	
		WICSTYLE 75evo	Form cutter, right hand cutting Outer Ø: 200 mm, inner Ø: 40 mm, no. of tooth: 12, angle: 60°	
			1916009,1916338,1917009,1917338	
5060021	1 St. 1 pcs	WICSTYLE 65evo	Formfräser linksschneidend Außen Ø: 200 mm, Bohrung Ø: 40 mm, Zähnezahl: 12, Winkel: 60°	
		WICSTYLE 75evo	Form cutter, left hand cutting Outer Ø: 200 mm, inner Ø: 40 mm, no. of tooth: 12, angle: 60°	
			1916009,1916338,1917009,1917338	
5060428	1 St. 1 pcs	WICSTYLE 75evo	Formfräser rechtsschneidend Außen Ø: 200 mm, Bohrung Ø: 40 mm, Zähnezahl: 12, Winkel: 60°	
			Form cutter, right hand cutting Outer Ø: 200 mm, inner Ø: 40 mm, no. of tooth: 12, angle: 60°	
			1020503,1020504	
5060429	1 St. 1 pcs	WICSTYLE 75evo	Formfräser linksschneidend Außen Ø: 200 mm, Bohrung Ø: 40 mm, Zähnezahl: 12, Winkel: 60°	
			Form cutter, left hand cutting Outer Ø: 200 mm, inner Ø: 40 mm, no. of tooth: 12, angle: 60°	
			1020503,1020504	





Verschiedenes
Miscellaneous

Artikel Article	VE PU	Anwendung Application	Bezeichnung / Hinweise Designation / Indications	Abbildung Figure
		Material / Material Farbe / Colour	Zuordnung Assignment	
5060024	1 St. 1 pcs	WICSTYLE 65evo	Diamant-Sägeblatt zur Verarbeitung unserer Systemprofile aus Aluminium, hohe Standzeit	
		WICSTYLE 75evo	Diamond saw blade for processing our system profiles made of aluminium, high operating life.	
5060025	1 St. 1 pcs	WICSTYLE 65evo	Diamant-Fräser Ø 10 mm x 100 mm, nutzbare Schneide 20 mm, zur Verarbeitung unserer Systemprofile aus Aluminium, hohe Standzeit	
		WICSTYLE 75evo	Diamond milling cutter Ø10 mm x 100 mm, usable cutting edge 20 mm, for processing our system profiles made of aluminium, high operating life	
5960007	1 St. 1 pcs	WICSTYLE 65evo	Torx Schraubendreher T10 auf Längsgriff	
		WICSTYLE 75evo	Torx screw driver T10 with longitudinal handle	
5060031	1 St. 1 pcs	WICSTYLE 65evo	Torx Schraubendreher T25 auf Längsgriff	
		WICSTYLE 75evo	Torx screwdriver T25 with longitudinal handle	
5060032	1 St. 1 pcs	WICSTYLE 65evo	Torx Schraubendreher T25 auf Quergriff	
		WICSTYLE 75evo	Torx screwdriver T25 with cross handle	

Verschiedenes
Miscellaneous







Artikel Article	VE PU	Anwendung Application	Bezeichnung / Hinweise Designation / Indications	Abbildung Figure
		Material / Material Farbe / Colour	Zuordnung Assignment	
5060051	1 St. 1 pcs	WICSTYLE 65evo	Profi-Drucklufthammer inkl. Setzdorn Eck- und Stoßverbindung	
		WICSTYLE 75evo	Professional pneumatic hammer including set mandrel for corner and butt-joint connections	
5060053	1 St. 1 pcs	WICSTYLE 65evo	Setzdorn für Hülse Ø6 mm auf Profi Drucklufthammer 5060051 Eck- und Stoßverbindung	
		WICSTYLE 75evo	Set mandrel mounted on professional pneumatic hammer 5060051 for Ø6 mm drive bush for corner and butt-joint connection	
5060055	1 St. 1 pcs	WICSTYLE 65evo	Setzdorn für Hülse Ø6 mm manuell Eck- und Stoßverbindung	
		WICSTYLE 75evo	Set mandrel for Ø6 mm drive bush, manual for corner and butt-joint connection	
5060056	1 St. 1 pcs	WICSTYLE 65evo	Setzdorn für Ø4 mm Stift 4070004 manuell zum Setzen der Ø4 mm Schlaghülsen	
		WICSTYLE 75evo	Set mandrel for Ø4 mm pin 4070004, manual for setting Ø4 mm bushes	
5060060	1 St. 1 pcs	WICSTYLE 65evo	Roller mit Kunststoffwanne für Kleberauftrag auf Schnittfläche Eck- und Stoßverbindung	
		WICSTYLE 75evo	Roller with plastic tray for application of adhesive on cut surfaces of profiles for corner and butt-joint connections	



Verschiedenes
Miscellaneous

Artikel Article	VE PU	Anwendung Application	Bezeichnung / Hinweise Designation / Indications	Abbildung Figure
		Material / Material Farbe / Colour	Zuordnung Assignment	
5060061	1 St. 1 pcs	WICSTYLE 65evo WICSTYLE 75evo	Ersatzrolle für Roller 5060060	
			Replacement roller for roller 5060060	
5060422	1 St. 1 pcs	WICSTYLE 65evo WICSTYLE 75evo	Schnittkanten-Abdichtungsmaschine zur Anwendung von WICPRO-Tector zum Abdichtung von Profil-Schnittflächen. Ersatzfolie 5070229.	
			Cut surfaces sealing machine for application of WICPRO-Tector for sealing profile cut surfaces. Replacement foil 5070229.	
5060424	1 Garn. 1 set	WICSTYLE 65evo WICSTYLE 75evo	Kartuschenpresse, akkubetrieben 10,8 V / 1,5 Ah für 2K Klebstoff 2 x 310 ml, Eck- und Stoßverbindung	
			Cartridges press, rech. battery-powered 10,8 V / 1,5 Ah for 2C adhesive 2 x 310 ml, angle and butt joints	
5060425	1 St. 1 pcs	WICSTYLE 65evo WICSTYLE 75evo	Ersatzakku 10,8 V / 1,5 Ah Li-Ion für Injektionspistole akkubetrieben	
			Replacement accu 10,8 V / 1,5 Ah Li-Ion for injection gun battery powered	

Artikel Article	VE PU	Anwendung Application	Bezeichnung / Hinweise Designation / Indications	Abbildung Figure
		Material / Material Farbe / Colour	Zuordnung Assignment	
5060426	1 St. 1 pcs	WICSTYLE 65evo WICSTYLE 75evo	Kartuschenpresse, manuell für 2K Klebstoff 2 x 310 ml, Eck- und Stoßverbindung Cartridges press, manual for 2C adhesive 2 x 310 ml, angle and butt joints	
5060070	1 St. 1 pcs	WICSTYLE 65evo WICSTYLE 75evo	Injektionspistole manuell Eck- und Stoßverbindung Injection pistol, manual Corner and butt-joint connections	
5060071	1 St. 1 pcs	WICSTYLE 65evo WICSTYLE 75evo	Injektionspistole pneumatisch Eck- und Stoßverbindung Injection pistol, pneumatic Corner and butt-joint connections	
5060073	1 St. 1 pcs	WICSTYLE 65evo WICSTYLE 75evo	Klebstoffportioniergerät Adhesive portioning apparatus	
5060075	1 St. 1 pcs	WICSTYLE 65evo WICSTYLE 75evo	Reinigungsmittelspender als Sparanfeuchter Cleaner-dispenser as economy dampener	
5060076	1 St. 1 pcs	WICSTYLE 65evo WICSTYLE 75evo	Sprühdose pneumatisch Spray can, pneumatic	

Verschiedenes
Miscellaneous





Artikel Article	VE PU	Anwendung Application	Bezeichnung / Hinweise Designation / Indications	Abbildung Figure
		Material / Material Farbe / Colour	Zuordnung Assignment	
5060077	1 St. 1 pcs	WICSTYLE 65evo WICSTYLE 75evo	Druckluft-Tankstelle für Sprühdose Compressed air filling station for spray can	
5960006	1 St. 1 pcs	WICSTYLE 65evo WICSTYLE 75evo	Dichtungseinrollwerkzeug für Mitteldichtung Gasket rolling tool for centre gasket	
5060080	1 St. 1 pcs	WICSTYLE 65evo WICSTYLE 75evo	Dichtungsschere Gasket shear	
5060089	1 St. 1 pcs	WICSTYLE 65evo WICSTYLE 75evo	Ersatzklingen für Dichtungsschere 5060080 Replacement blades for gasket shear 5060080	
5060101	1 St. 1 pcs	WICSTYLE 65evo WICSTYLE 75evo	Abspulbock für Dichtungsprofile auf Mehrwegspule Gasket reel support rack for gasket profiles on reusable reels	
5060102	1 St. 1 pcs	WICSTYLE 65evo WICSTYLE 75evo	Abroller für Dichtungsprofile auf Mehrwegspule Portable reel holder for gasket profiles on reusable reels,	





Artikel Article	VE PU	Anwendung Application	Bezeichnung / Hinweise Designation / Indications	Abbildung Figure
		Material / Material Farbe / Colour	Zuordnung Assignment	
5060103	1 St. 1 pcs	WICSTYLE 65evo WICSTYLE 75evo	Beschlagsmontagewagen klein <i>Trolley for installation of fittings, small</i>	
5060104	1 St. 1 pcs	WICSTYLE 65evo WICSTYLE 75evo	Beschlagsmontagewagen groß <i>Trolley for installation of fittings, large</i>	
5060105	1 St. 1 pcs	WICSTYLE 65evo WICSTYLE 75evo	Arbeitstisch <i>Work-bench</i>	
5060107	1 St. 1 pcs	WICSTYLE 65evo WICSTYLE 75evo	Folienabroller für Folienarbeiten bis 150 mm Selbstzuschnitt aus Rolle 5070043 <i>Foil dispenser</i> <i>for foil works up to 150 mm width, cut to size from</i> <i>the roll 5070043</i>	
5960017	1 St. 1 pcs	WICSTYLE 65evo	Montagehilfe für BAP-System 65 Blendrahmen Bautiefe 65 mm <i>Assembly help for BAP system 65</i> <i>Frame construction depth 65 mm</i>	
5960018	1 St. 1 pcs	WICSTYLE 75evo	Montagehilfe für BAP-System 75 Blendrahmen Bautiefe 75 mm <i>Assembly help for BAP system 75</i> <i>Frame construction depth 75 mm</i>	





Verschiedenes
Miscellaneous



Artikel Article	VE PU	Anwendung Application	Bezeichnung / Hinweise Designation / Indications	Abbildung Figure
		Material / Material Farbe / Colour	Zuordnung Assignment	
5960019	1 St. 1 pcs	WICSTYLE 65evo	Klinkmesser für BAP-System	
		WICSTYLE 75evo	Zur Eckausbildung bei Montage BAP-System	
			Notching cutter for BAP system Corner formation for assembly BAP system	

Artikel Article	VE PU	Anwendung Application	Bezeichnung / Hinweise Designation / Indications	Abbildung Figure
		Material / Material Farbe / Colour	Zuordnung Assignment	
5070000	1 Set 1 set	WICSTYLE 65evo WICSTYLE 75evo	2-Komponenten Polyurethan-Klebstoff in Tandemkartusche 1 Set = 6 Stück inkl. 8 Statikmischer zum Verkleben von Al-Profilen	
			2-component Polyurethane adhesive in tandem cartridge 1 set = 6 pieces including 8 mixing nozzle to glue aluminium profiles	
5970002	1 Set 1 set	WICSTYLE 65evo WICSTYLE 75evo	2-Komponenten Polyurethan-Klebstoff, schwarz in Tandemkartusche 1 Set = 6 Stück inkl. 8 Statikmischer zum Verkleben von Al-Profilen	
			2-component Polyurethane adhesive, black in tandem cartridge 1 set = 6 pieces including 8 mixing nozzle to glue aluminium profiles	
5070001	20 St. 20 pcs	WICSTYLE 65evo WICSTYLE 75evo	Statikmischer für Tandemkartusche	
			Mixing nozzle for tandem cartridge	
5070002	1 Set 1 set	WICSTYLE 65evo WICSTYLE 75evo	2-Komponenten Epoxid-Klebstoff in Dosengebinde für Portioniergerät Komponenten A+B zum Verkleben von Al- Profilen	
			2-component epoxy adhesive in tins for portioning apparatus, component A+B, to glue aluminium profiles	
5070224	1 St. 1 pcs	WICSTYLE 65evo WICSTYLE 75evo	WICPRO-Tector zum Abdichten von Schnittkanten, weiß	
			WICPRO-Tector for sealing mitre cut surfaces, white	



Artikel Article	VE PU	Anwendung Application	Bezeichnung / Hinweise Designation / Indications	Abbildung Figure
		Material / Material Farbe / Colour	Zuordnung Assignment	
5070225	1 St. 1 pcs	WICSTYLE 65evo	WICPRO-Tector zum Abdichten von Schnittkanten, grau	
		WICSTYLE 75evo	WICPRO-Tector for sealing mitre cut surfaces, grey	
5070226	1 St. 1 pcs	WICSTYLE 65evo	WICPRO-Tector zum Abdichten von Schnittkanten, schwarz	
		WICSTYLE 75evo	WICPRO-Tector for sealing mitre cut surfaces, black	
5070227	10 St. 10 pcs	WICSTYLE 65evo	2-Komponenten Polyurethan-Klebstoff in Tandemkartusche 2 x 310 ml 1 Set = 10 Stück inkl. 10 Statikmischer zum Verkleben von Al- Profilen	
		WICSTYLE 75evo	2 components polyurethane adhesive in tandem cartridge 2 x 310ml 1 set = 10 pieces including 10 mixing nozzles to glue aluminium profiles	
5070003	1 St. 1 pcs	WICSTYLE 65evo	Farbpaste weiß zum Einfärben von Klebstoff	
		WICSTYLE 75evo	Colour paste, white for colouration of adhesive	
5070004	1 Set 1 set	WICSTYLE 65evo	Farbpalette mit 5 Grundfarben, zum Einfärben von Klebstoff	
		WICSTYLE 75evo	Colour palette with 5 basic colours, for colouration of adhesive	

Artikel Article	VE PU	Anwendung Application	Bezeichnung / Hinweise Designation / Indications	Abbildung Figure
		Material / Material Farbe / Colour	Zuordnung Assignment	
5070012	1 St. 1 pcs	WICSTYLE 65evo WICSTYLE 75evo	Dichtungskleber, schwarz Gasket glue, black	
5070015	1 St. 1 pcs	WICSTYLE 65evo WICSTYLE 75evo	Reinigungsmittel 1 l für pulverbeschichtete und eloxierte Profile Cleaning agent, 1 litre for powder coated and anodized profiles	
5070016	1 St. 1 pcs	WICSTYLE 65evo WICSTYLE 75evo	Reinigungsmittel 10 l für pulverbeschichtete und eloxierte Profile Cleaning agent, 10 litre for powder coated and anodized profiles	
5070024	1 St. 1 pcs	WICSTYLE 65evo WICSTYLE 75evo	Gleitfett säure- und harzfrei zum Fetten der Beschläge beim Einbau Grease free from acid and resin to lubricate fittings while assembling	
5070025	1 St. 1 pcs	WICSTYLE 65evo WICSTYLE 75evo	Pflegespray für Stanzen und Beschläge säure- und harzfrei zum nachträglichen Pflegen und Fetten der Beschlagsteile und Stanzwerkzeuge Maintenance spray for punching and fittings free from acid and resin for subsequent maintenance and greasing of fitting parts and punching tools	

Artikel Article	VE PU	Anwendung Application	Bezeichnung / Hinweise Designation / Indications	Abbildung Figure
		Material / Material Farbe / Colour	Zuordnung Assignment	
5070229	12 St. 12 pcs	WICSTYLE 65evo	Ersatzfolie für Schnittkanten-Abdichtungsmaschine 5060422.	
		WICSTYLE 75evo	Replacement foil for cut surfaces sealing machine 5060422.	
5070043	100 m 100 m	WICSTYLE 65evo	Schutzfolie 1250 mm für Selbstzuschnitt, selbsthaftend, Transportschutz für behandelte Profile	
		WICSTYLE 75evo	Protective foil 1250 mm for cut to size, self-adhesive, as transport protection for surface treated profiles	
5070044	20 St. 20 pcs	WICSTYLE 65evo	Dichtmasse, silikonfrei 310 ml zum Abdichten in Fällen, wo silikonhaltige Stoffe nicht zulässig sind. Farbe: schwarz	
		WICSTYLE 75evo	Sealing compound, without silicone, 310 ml to seal in cases where materials containing silicone are not permissible. Colour: black	
5370004	5 St. 5 pcs	WICSTYLE 65evo	Reinigungsmittel 1 l Sonderreiniger für die Schweiz	
		WICSTYLE 75evo	Cleaning agent, 1 litre Special cleaner for Switzerland	
5370005	1 St. 1 pcs	WICSTYLE 65evo	Reinigungsmittel 10 l Sonderreiniger für die Schweiz	
		WICSTYLE 75evo	Cleaning agent 10 litre Special cleaner for Switzerland	

Artikel Article	VE PU	Anwendung Application	Bezeichnung / Hinweise Designation / Indications	Abbildung Figure
		Material / Material Farbe / Colour	Zuordnung Assignment	
5970003	20 St. 20 pcs	WICSTYLE 65evo	SILCOSEAL Silikon-Dichtmasse 310 ml, schwarz zum Abdichten von Baufugen, für Abdichtungsarbeiten bei Riegelstößen oder zur Hinterlegung auf Gehrung geschnittener Glasdichtungen.	
		WICSTYLE 75evo	SILCOSEAL Silicone sealant, 310 ml, black <i>for sealing construction joints, transom joints or backlining mitre cut glazing gaskets.</i>	
5970004	20 St. 20 pcs	WICSTYLE 65evo	SILCOSEAL Silikon-Dichtmasse 310 ml, grau zum Abdichten von Baufugen, für Abdichtungsarbeiten bei Riegelstößen oder zur Hinterlegung auf Gehrung geschnittener Glasdichtungen.	
		WICSTYLE 75evo	SILCOSEAL Silicone sealant, 310 ml, grey <i>for sealing construction joints, transom joints or backlining mitre cut glazing gaskets.</i>	
5970006	1 Flasche 1 bottle	WICSTYLE 65evo	Primer / Reiniger 1,0 l in Kombination mit SILCOSEAL Silikon-Dichtmasse zur Vorbehandlung und Haftverbesserung auf beschichteten und unbeschichteten metallischen Werkstoffen. Beschichtung vor Anwendung prüfen, Datenblatt beachten.	
		WICSTYLE 75evo	Primer / Cleaner, 1.0 litre <i>in combination with SILCOSEAL silicone sealant for pre-treatment and adhesion improvements on coated and uncoated metals. Test coating prior to application, pay attention to data specification.</i>	

Abdichtungen
Sealings

Artikel Article	VE PU	Anwendung Application	Bezeichnung / Hinweise Designation / Indications	Abbildung Figure
		Material / Material Farbe / Colour	Zuordnung Assignment	
5970007	80 m 80 m	WICSTYLE 65evo	Fugendichtband BAP-System 65 65 mm x 6-20 mm, schwarz	
		PUR, geschäumt PUR, foamed	Joint sealing strip BAP system 65 65 mm x 6-20 mm, black	
5970008	80 m 80 m	WICSTYLE 75evo	Fugendichtband BAP-System 75 75 mm x 6-20 mm, schwarz	
		PUR, geschäumt PUR, foamed	Joint sealing strip BAP system 75 75 mm x 6-20 mm, black	

	Seite Page
Statik - Richtlinien <i>Static guidelines</i>	7/3
Statikdiagramm <i>Static diagram</i>	7/5
Statikdiagramm Windlast <i>Static diagram wind load</i>	7/6
Statikdiagramm Glaslast <i>Static diagram glass load</i>	7/18
EN Normen <i>European standards</i>	7/20
Statische Werte, WICSTYLE 75 evo <i>Statical values, WICSTYLE 75 evo</i>	7/21
Statische Werte, WICSTYLE 65 evo / 65 <i>Statical values, WICSTYLE 65 evo / 65</i>	7/34
WICSTYLE 75 evo	
Eckwinkelzuschnitt / Auswahltabellen <i>Cutting corner angle / Selection tables</i>	7/48
Zuordnung Gelenkeckwinkel, vertikal <i>Assignment hinged corner angle, vertical</i>	7/51
Zuordnung Gelenkeckwinkel, horizontal <i>Assignment hinged corner angle, horizontal</i>	7/52
Zuordnung Gelenkverbinder <i>Assignment hinged connector</i>	7/53
WICSTYLE 65 evo / 65	
Eckwinkelzuschnitt / Auswahltabellen <i>Cutting corner angle / Selection tables</i>	7/54
Zuordnung Gelenkeckwinkel, vertikal <i>Assignment hinged corner angle, vertical</i>	7/57
Zuordnung Gelenkeckwinkel, horizontal <i>Assignment hinged corner angle, horizontal</i>	7/58
Zuordnung Gelenkverbinder <i>Assignment hinged connector</i>	7/59
Sprossenstoßverbindungen <i>Glazing bar butt-joint connections</i>	7/60
Normen Information, Fenster durchschusshemmend <i>Information about standards, bullet resistant</i>	7/66
Durchschusshemmende Verglasung / Bauteile <i>Bullet resistant glazing / components</i>	7/67
Übersicht einbruchhemmende Bauteile <i>Survey of burglar resistance components</i>	7/73
Zertifikate <i>Certificates</i>	7/74

EN 14024

Anforderungen und mechanisches Leistungsverhalten von Metallprofilen mit thermischer Trennung (Verbundprofile)

Requirements and mechanical performance of metal profiles with thermal break (Composite profiles)

Vorbemerkung

Die statischen Erfordernisse von tragenden Gliedern sind entsprechend den jeweiligen Anforderungen zu dimensionieren. In vielen Anwendungsfällen ist ein statischer Nachweis erforderlich.

Definition: Metallprofil mit thermischer Trennung

Verbundprofil, zusammengesetzt aus zwei oder mehr Metallprofilen, die miteinander durch mindestens einen wärmedämmenden Bestandteil (nichtmetallisch) verbunden sind.

Die statischen Eigenschaften von Verbundprofilen und deren Nachweis unterscheiden sich wesentlich von Traggliedern aus nur einem Grundwerkstoff.

Inhalt der Norm (Deutsche Fassung)

In dieser Norm sind die Anforderungen an die Beurteilung der mechanischen Festigkeit von Verbundprofilen festgelegt. Es legt auch die Prüfungen zur Bestimmung der charakteristischen Werte von mechanischen Eigenschaften des Verbundprofils und die Beurteilung der Eignung der als thermische Trennung verwendeten Werkstoffe fest. Dieses Dokument gilt für Verbundprofile, die hauptsächlich für Fenster, Türen, Fensterwände und Vorhangfassaden vorgesehen sind.

Kategorien für den Gebrauch

Kategorie W

Metallprofile mit thermischer Trennung hauptsächlich für Fenster, Türen und Sekundärbauteile von Vorhangfassaden.

Anmerkung

Verbundprofile für Fenster und Türen erfordern gewöhnlich keinen Nachweis für die Berechnung der mechanischen Festigkeit.

Kategorie CW

Metallprofile mit thermischer Trennung hauptsächlich für die Bauteile von Vorhangfassaden mit Spannweiten größer als 2,25 m.

Der Nachweis beinhaltet neben den üblichen Lasten (Eigengewicht, Wind, weitere Verkehrslasten) im besonderen Temperaturbelastungen (Sommer, Winter) und deren Auswirkungen auf die Biegespannungen und Schubspannungen, speziell auf die nachgewiesenen Eigenschaften des „Elastischen Verbundes“ dieser Profile.

Verformungsbemessung – Ermittlung der Trägheitsmomente

Die zul. Verformung der Profile wird im Regelfall durch die Füllung definiert.

Bsp.: Glasfüllung $f_{zul.} = L/200$, max. 15 mm.

Die Ermittlung des Trägheitsmomentes erfolgt abhängig von dieser Verformung (dem stat. System), der Stützweite und der Belastung. Bedingt durch die Theorie des elastischen Verbundes ergeben sich bei Metall-Kunststoff-Verbundprofilen stützweitenabhängig unterschiedliche Trägheitsmomente. Die Ermittlung der Trägheitsmomente erfolgt mit den bekannten Methoden und Tabellen.



Wichtiger Hinweis:

Die ausreichende statische Bemessung und sichere Tragfähigkeit der verwendeten Profile obliegt der Verantwortung des Anwenders.



Important hints:

Adequate static dimensioning and secured load bearing capacity of the used profiles lies in the responsibility of user.

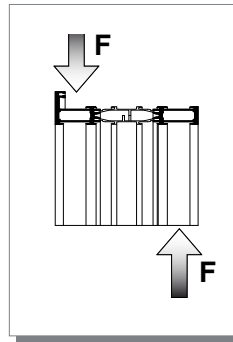

Schubfestigkeit
Shear strength

Preliminary remarks

The static requirements of supporting elements should be dimensioned according to the respective requirements. A statical evidence is necessary in many cases of application.

Definition: Metal profile with thermal break

Composite profile of two or more metal profiles connected with each other through minimum one insulating component (non-metallic).

The statical characteristics of composite profiles and their evidence differ substantially from supporting elements of only one base material.

Contents of Standard

Requirements on the evaluation of mechanical strength of composite profiles are specified in this standard. It also prescribes the tests for determining the characteristic value of mechanical properties of composite profiles and the evaluation of applicability of used material as thermal insulation. This document applies for composite profiles which are provided mainly for windows, doors, window walls and curtain walls.

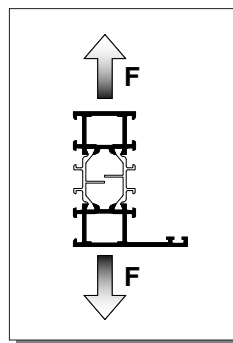

Querzugfestigkeit
Transverse tensile strength

Categories for use

Category W

Metal profiles with thermal break mainly for windows, doors and secondary structural components of curtain walls.

Annotation

Usually, composite profiles for windows and doors do not require evidence for the calculation of mechanical strength.

Category CW

Metal profiles with thermal break mainly for structural components of curtain walls with span widths larger than 2.25 m.

Next to the usual loads (own weight, wind, further live loads), the evidence includes particularly thermal loads (summer, winter) and their influence on bending stresses and shearing stresses, especially on the proven properties of "composite elasticity" of these profiles.

Dimensioning deformation - Determination of moment of inertia

As a rule, the admissible deformation of profiles is defined through the infill.

Example: Glass infill $f_{adm.} = L/200$, max. 15 mm.

The determination of moment of inertia follows depending on this deformation (static system) of bearing span and load.

Induced by the theory of composite elasticity, the different moments of inertia of metal-plastic composite profiles result from the bearing span dependent width. The determination of moment of inertia follows with the known methods and tables.

Die benötigten Lasten wie Windlast, Eigenlast und Verkehrslast für die nachfolgenden Diagramme sind den jeweils gültigen nationalen Normen und Vorschriften zu entnehmen.

Anwendung der verschiedenen Diagramme

Rechtecklast Diagramme 1 – 3 und Dreieck- und Trapezlast Diagramme 4 – 6

Die Diagramme für Dreieck- und Trapezlast sind für eine annähernde Bestimmung des erforderlichen Trägheitsmomentes in x-Richtung anwendbar, d. h. Belastung senkrecht zur Verglasung. Bei Dreieck- und Trapezbelastung wird die Lastaufteilung nach DIN 1045 angenommen. Die Aufteilung erfolgt durch die Halbierung der Winkel. (Nach DIN 1045 für allseitig frei gelagerte Platte).

Glaslast Diagramm 7

Das Diagramm für Glaslast ist für eine annähernde Bestimmung des erforderlichen Trägheitsmomentes bei Riegeln und Kämpfern in y-Richtung anwendbar, d. h. in Belastungsrichtung der Verglasung. Als zulässige Durchbiegung werden $f_{zul} = 3 \text{ mm}$ angenommen.

The required loads for the following diagrams, such as wind load, dead load and live load are to be determined according to the respective valid national standards and instructions.

Application of the different diagrams

Rectangular load diagrams 1 – 3 and Triangular and trapezoidal load diagrams 4 – 6

The diagrams for triangular and trapezoidal load are applicable for a approx. determination of the required moment of inertia in x-direction, i.e. load perpendicular to glazing. For triangular and trapezoidal load the load distribution is assumed according to DIN 1045. The distribution is carried out by means of dividing the angles in two (plate with no bearings all over according to DIN 1045).

Glass load diagram 7

The diagram for glass load is applicable for an approx. determination of the required moment of inertia for transom in y-direction, i.e. in the load direction of the glazing. The admissible deflection is assumed $f_{adm} = 3 \text{ mm}$.

Lastaufteilung bei Rechtecklast
*Load distribution rectangular load
(curtain wall)*

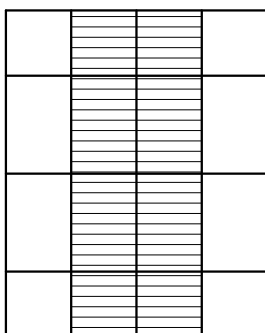

tatsächliche Aufteilung
auf die Stütze
*actual distribution on the
mullion*

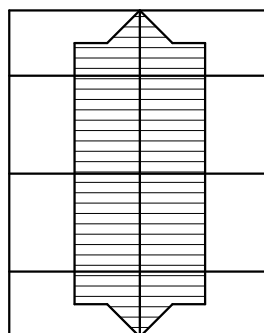

Lastaufteilung nach
DIN 1045
*Load distribution according
to DIN 1045*

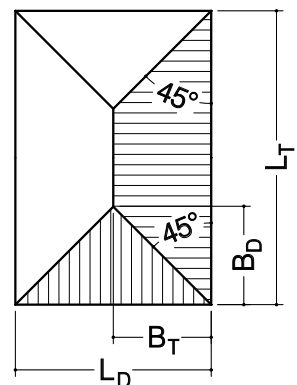

Die nachfolgenden Diagramme dienen zur überschlägigen Ermittlung der erforderlichen Trägheitsmomente. Die Diagramme sind nach bestem Wissen gefertigt. Eine Gewähr für Fehlerfreiheit kann jedoch nicht übernommen werden. Für verbindliche Festlegungen ist eine statische Berechnung erforderlich.



The diagrams are applicable for a rough determination of the required moment of inertia. The diagrams have been made to the best of our knowledge. However, no responsibility is taken for its correctness. In order to obtain binding results a statical check is necessary.

$$f_{zul. / adm.} = L / 200$$

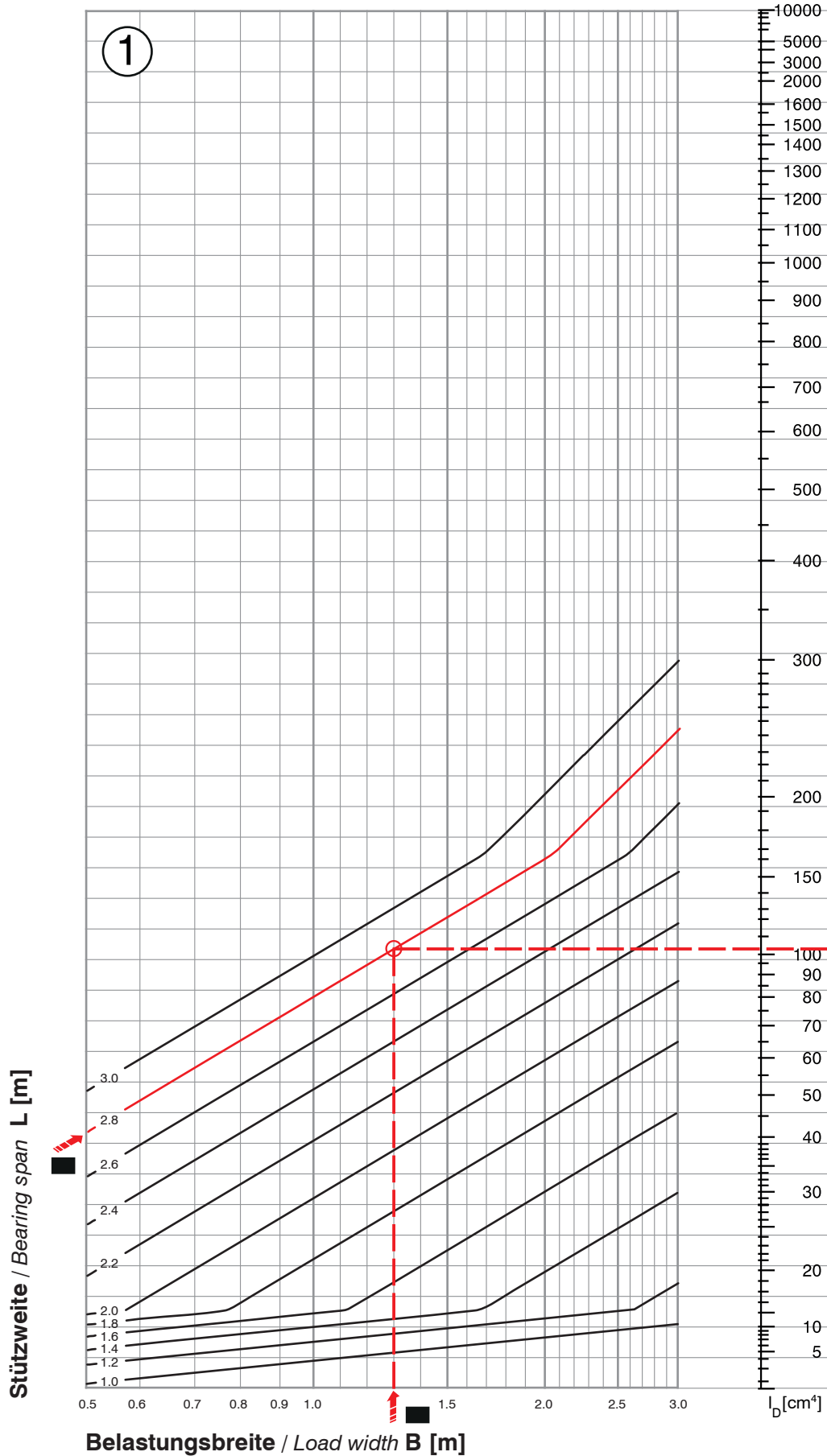

Rechtecklast (Einheitslast 1.0 kN/m²)
Rectangular load (Unit load 1.0 kN/m²)

$$f_{\text{zul. / adm.}} = L / 200$$

System / System

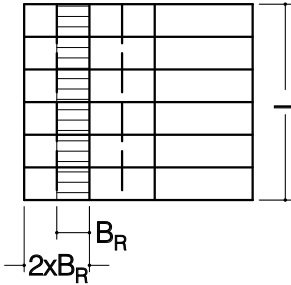

Anwendungsbeispiel Rechtecklast Example of application rectangular load

Stützweite / Bearing span:

$$L = 2.80 \text{ m}$$

Belastungsbreite / Load width:

$$B = 1.30 \text{ m}$$

Rechtecklast / Rectangular load:

$$I_D = 106 \text{ cm}^4 \text{ (⊙ abgelesen / is read)}$$

Ermittlung: erf. I_x / Determination: requ. I_x

Beispiel / Example:

Winddruck angenommen* / Wind pressure assumed*

$$= 0.64 \text{ kN/m}^2$$

$$\text{erf. / requ. } I_x = w_e \cdot I_D = 0.64 \cdot 106 \text{ cm}^4$$

$$= 67.8 \text{ cm}^4$$

Windsog angenommen* / Wind suction assumed*

$$= -1.12 \text{ kN/m}^2$$

$$\text{erf. / requ. } I_x = w_e \cdot I_D = (-1.12) \cdot 106 \text{ cm}^4$$

$$= 118.7 \text{ cm}^4$$

*die Windlast muß nach den gültigen Normen und nach Standort und Form des Gebäudes ermittelt werden.

*the wind suction must be determined according to the valid standards and to the position and shape of the building.

Statisches System Rechtecklast

Statical system rectangular load

Träger auf 2 Stützen / Beam on 2 supports

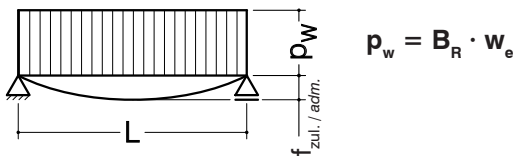

Berechnungsformel Rechtecklast

Calculation formula rectangular load

$$I_x = \frac{5 \cdot p_w \cdot L^4}{384 \cdot E \cdot f_{\text{zul. / adm.}}}$$

I_x	(cm ⁴)	= Trägheitsmoment / Moment of inertia
I_D	(cm ⁴)	= Trägheitsmoment, Rechtecklast / Moment of inertia, rectangular load
L	(cm)	= Stützweite / Bearing span
B	(cm)	= Belastungsbreite / Load width
w_e	(kN/cm ²)	= Winddruck/Windsog / Wind pressure/-depression
p_w	(kN/cm)	= Linienlast / Line load
E	(kN/cm ²)	= Elastizitätsmodul / Modulus of elasticity $7 \cdot 10^3$
$f_{\text{zul. / adm.}}$	(cm)	= zul. Durchbiegung / adm. deflection

$$f_{zul. / adm.} = L / 300$$

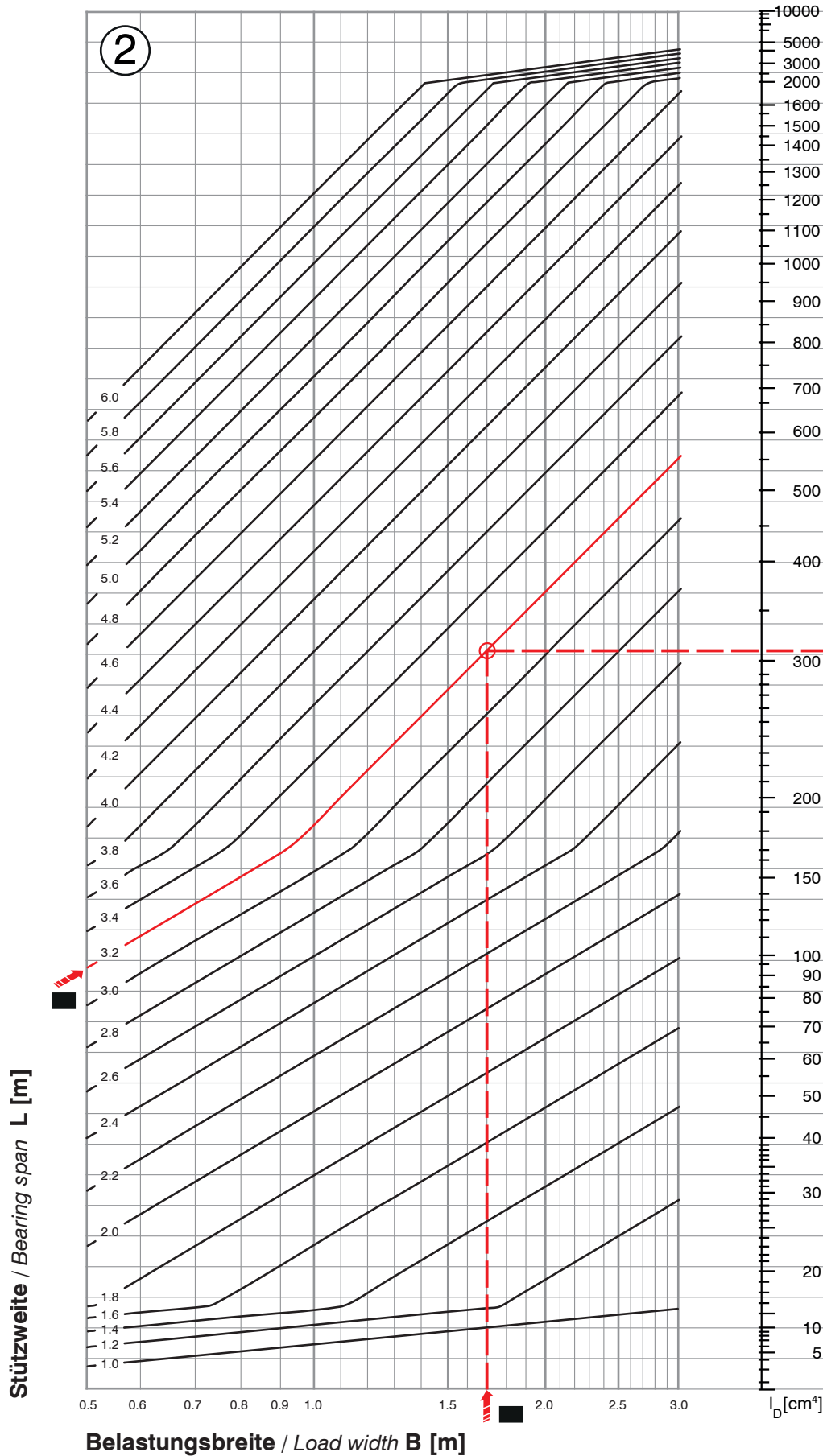

Rechtecklast (Einheitslast 1.0 kN/m²)
Rectangular load (Unit load 1.0 kN/m²)

$$f_{\text{zul. / adm.}} = L / 300$$

System / System

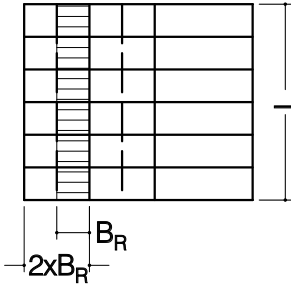

Anwendungsbeispiel Rechtecklast Example of application rectangular load

Stützweite / Bearing span:

$$L = 3.20 \text{ m}$$

Belastungsbreite / Load width:

$$B = 1.70 \text{ m}$$

Rechtecklast / Rectangular load:

$$I_D = 311 \text{ cm}^4 \text{ (⊗ abgelesen / is read)}$$

Ermittlung: erf. I_x / Determination: requ. I_x

Beispiel / Example:

Winddruck angenommen* / Wind pressure assumed*

$$= 0.64 \text{ kN/m}^2$$

$$\text{erf. / requ. } I_x = w_e \cdot I_D = 0.64 \cdot 311 \text{ cm}^4$$

$$= 199 \text{ cm}^4$$

Windsog angenommen* / Wind suction assumed*

$$= -1.12 \text{ kN/m}^2$$

$$\text{erf. / requ. } I_x = w_e \cdot I_D = (-1.12) \cdot 311 \text{ cm}^4$$

$$= 348.3 \text{ cm}^4$$

*die Windlast muß nach den gültigen Normen und nach Standort und Form des Gebäudes ermittelt werden.

*the wind suction must be determined according to the valid standards and to the position and shape of the building.

Statisches System Rechtecklast

Statical system rectangular load

Träger auf 2 Stützen / Beam on 2 supports

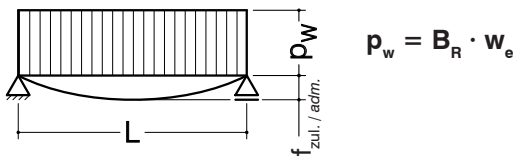

Berechnungsformel Rechtecklast

Calculation formula rectangular load

$$I_x = \frac{5 \cdot p_w \cdot L^4}{384 \cdot E \cdot f_{\text{zul. / adm.}}}$$

I_x	(cm ⁴) =	Trägheitsmoment / Moment of inertia
I_D	(cm ⁴) =	Trägheitsmoment, Rechtecklast / Moment of inertia, rectangular load
L	(cm) =	Stützweite / Bearing span
B	(cm) =	Belastungsbreite / Load width
w_e	(kN/cm ²) =	Winddruck/Windsog / Wind pressure/-depression
p_w	(kN/cm) =	Linienlast / Line load
E	(kN/cm ²) =	Elastizitätsmodul / Modulus of elasticity $7 \cdot 10^3$
$f_{\text{zul. / adm.}}$	(cm) =	zul. Durchbiegung / adm. deflection

$$f_{zul. / adm.} = L / 300 \text{ max. } 8 \text{ mm}$$

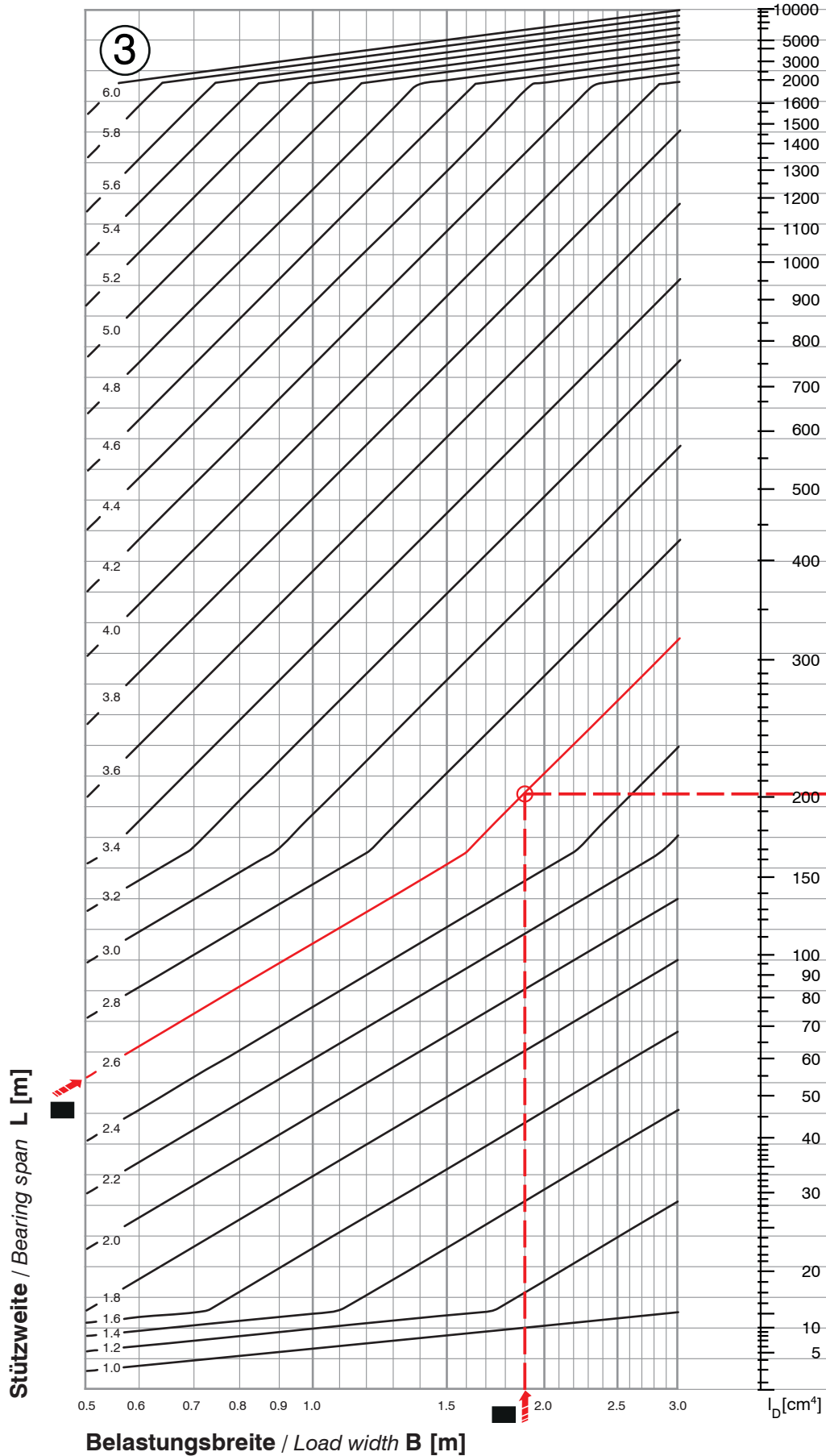

Rechtecklast (Einheitslast 1.0 kN/m²)
Rectangular load (Unit load 1.0 kN/m²)

$$f_{\text{zul. / adm.}} = L / 300 \text{ max. } 8 \text{ mm}$$

System / System

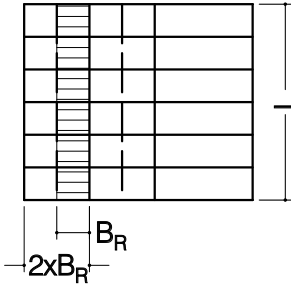

Anwendungsbeispiel Rechtecklast Example of application rectangular load

Stützweite / Bearing span:

$$L = 2.60 \text{ m}$$

Belastungsbreite / Load width:

$$B = 1.90 \text{ m}$$

Rechtecklast / Rectangular load :

$$I_D = 202 \text{ cm}^4 \text{ (} \textcircled{3} \text{ abgelesen / is read)}$$

Ermittlung: erf. I_x / Determination: requ. I_x

Beispiel / Example:

Winddruck angenommen* / Wind pressure assumed*

$$= 0.64 \text{ kN/m}^2$$

$$\text{erf. / requ. } I_x = w_e \cdot I_D = 0.64 \cdot 202 \text{ cm}^4$$

$$= 129.3 \text{ cm}^4$$

Windsog angenommen* / Wind suction assumed*

$$= -1.12 \text{ kN/m}^2$$

$$\text{erf. / requ. } I_x = w_e \cdot I_D = (-1.12) \cdot 202 \text{ cm}^4$$

$$= 226.2 \text{ cm}^4$$

*die Windlast muß nach den gültigen Normen und nach Standort und Form des Gebäudes ermittelt werden.

*the wind suction must be determined according to the valid standards and to the position and shape of the building.

Statisches System Rechtecklast

Statical system rectangular load

Träger auf 2 Stützen / Beam on 2 supports

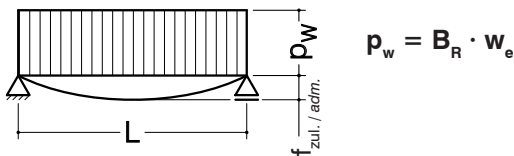

Berechnungsformel Rechtecklast

Calculation formula rectangular load

$$I_x = \frac{5 \cdot p_w \cdot L^4}{384 \cdot E \cdot f_{\text{zul. / adm.}}}$$

I_x	(cm ⁴) =	Trägheitsmoment / Moment of inertia
I_D	(cm ⁴) =	Trägheitsmoment, Rechtecklast / Moment of inertia, rectangular load
L	(cm) =	Stützweite / Bearing span
B	(cm) =	Belastungsbreite / Load width
w_e	(kN/cm ²) =	Winddruck/Windsog / Wind pressure/-depression
p_w	(kN/cm) =	Linienlast / Line load
E	(kN/cm ²) =	Elastizitätsmodul / Modulus of elasticity $7 \cdot 10^3$
$f_{\text{zul. / adm.}}$	(cm) =	zul. Durchbiegung / adm. deflection

Dreieck- und Trapezlast (Einheitslast 1.0 kN/m²)
Triangular and trapezoidal load (Unit load 1.0 kN/m²)

$$f_{zul. / adm.} = L / 200$$

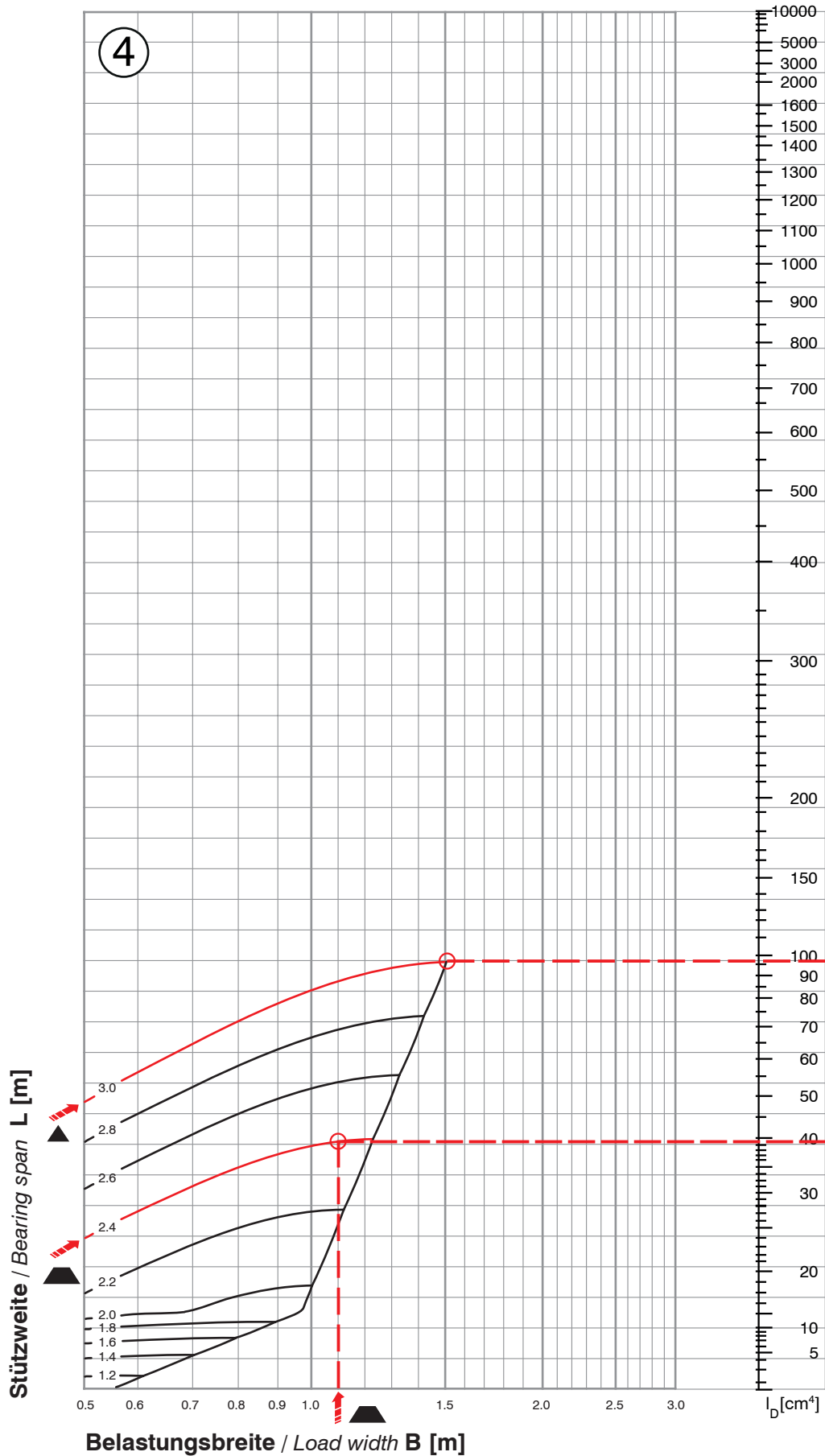

Dreieck- und Trapezlast (Einheitslast 1.0 kN/m²)
Triangular and trapezoidal load (Unit load 1.0 kN/m²)

$$f_{zul./adm.} = L / 200$$

System / System

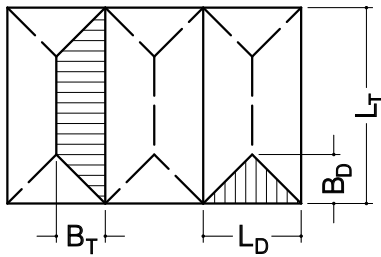

Anwendungsbeispiel Trapezlast

Example of application trapezoidal load

Stützweite / Bearing span:

$$L_T = 2.40 \text{ m}$$

Belastungsbreite / Load width:

$$B_T = 1.10 \text{ m}$$

Rechtecklast / Rectangular load:

$$I_D = 39 \text{ cm}^4 \text{ (④ abgelesen / is read)}$$

Statisches System Trapezlast

Statical system trapezoidal load

Träger auf 2 Stützen / Beam on 2 supports

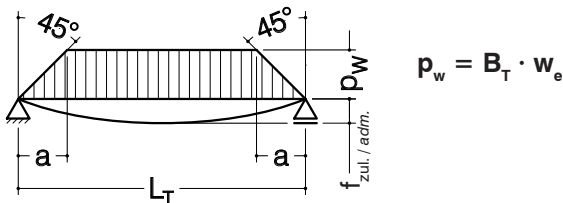

Ermittlung: erf. I_x / Determination: requ. I_x

Beispiel / Example:

Winddruck angenommen* / Wind pressure assumed*

$$= 0.64 \text{ kN/m}^2$$

erf. / requ. $I_x = w_e \cdot I_D = 0.64 \cdot 39 \text{ cm}^4$

$$= 25.0 \text{ cm}^4$$

Berechnungsformel Trapezlast

Calculation formula trapezoidal load

$$I_{xT} = \frac{p_w \cdot L_T^4}{1920 \cdot E \cdot f_{zul./adm.}} \cdot \left(25 - 40 \frac{a^2}{L_T^2} + 16 \frac{a^4}{L_T^4} \right)$$

Windsog angenommen* / Wind suction assumed*

$$= -1.12 \text{ kN/m}^2$$

erf. / requ. $I_x = w_e \cdot I_D = (-1.12) \cdot 39 \text{ cm}^4$

$$= 43.7 \text{ cm}^4$$

Statisches System Dreiecklast

Statical system triangular load

Träger auf 2 Stützen / Beam on 2 supports

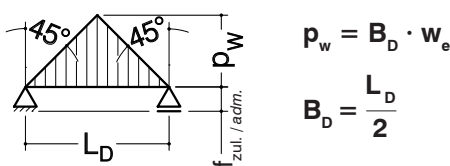

*die Windlast muß nach den gültigen Normen und nach Standort und Form des Gebäudes ermittelt werden.

*the wind suction must be determined according to the valid standards and to the position and shape of the building.

Berechnungsformel Dreiecklast

Calculation formula triangular load

$$I_{xD} = \frac{p_w \cdot L^4}{120 \cdot E \cdot f_{zul./adm.}}$$

I_x (cm⁴) = Trägheitsmoment / Moment of inertia

L_D (cm) = Stützweite Dreiecklast / Bearing span triangular load

L_T (cm) = Stützweite Trapezlast / Bearing span trapezoidal load

B_D (cm) = Belastungsbreite Dreiecklast / Load width triangular load $B_D = L_D/2$

B_T (cm) = Belastungsbreite Trapezlast / Load width trapezoidal load

w_e (kN/cm²) = Winddruck/Windsog / Wind pressure/-depression

p_w (kN/cm) = Linienlast / Line load

E (kN/cm²) = Elastizitätsmodul / Modulus of elasticity $7 \cdot 10^3$

$f_{zul./adm.}$ (cm) = zul. Durchbiegung / adm. deflection

$$f_{zul. / adm.} = L / 300$$

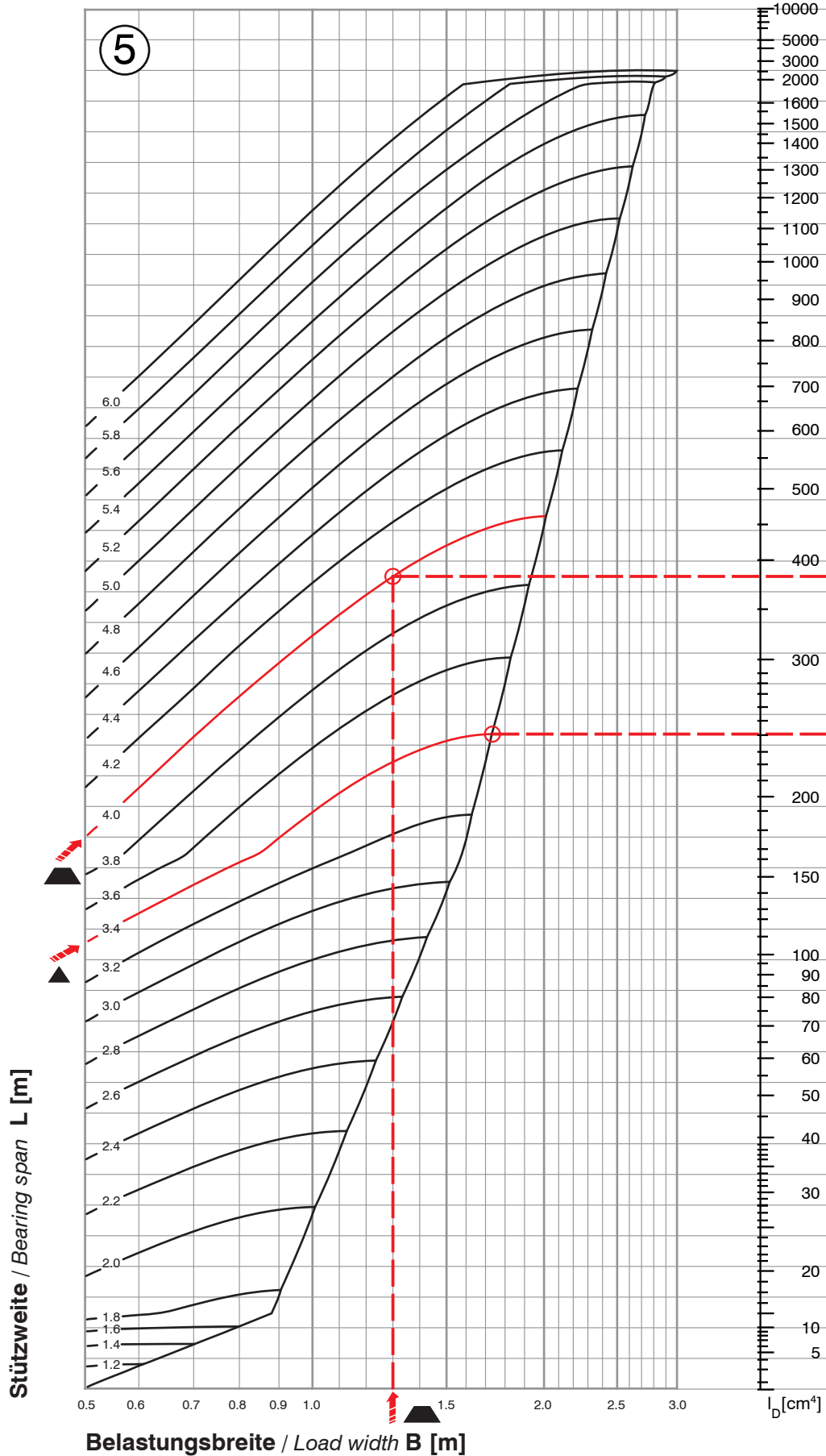

Dreieck- und Trapezlast (Einheitslast 1.0 kN/m²)
Triangular and trapezoidal load (Unit load 1.0 kN/m²)

$$f_{zul./adm.} = L / 300$$

System / System

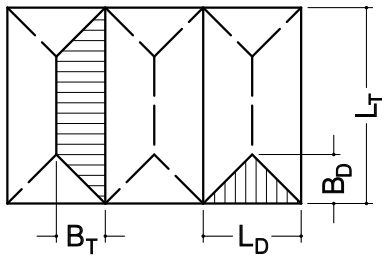

Anwendungsbeispiel Trapezlast

Example of application trapezoidal load

Stützweite / Bearing span:

$$L_T = 4.00 \text{ m}$$

Belastungsbreite / Load width:

$$B_T = 1.30 \text{ m}$$

Rechtecklast / Rectangular load:

$$I_D = 389 \text{ cm}^4 \text{ (⊗ abgelesen / is read)}$$

Statisches System Trapezlast

Statical system trapezoidal load

Träger auf 2 Stützen / Beam on 2 supports

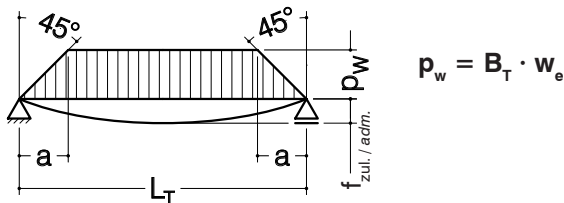

$$p_w = B_T \cdot w_e$$

Ermittlung: erf. I_x / Determination: requ. I_x

Beispiel / Example:

Winddruck angenommen* / Wind pressure assumed*

$$= 0.64 \text{ kN/m}^2$$

$$\text{erf. / requ. } I_x = w_e \cdot I_D = 0.64 \cdot 389 \text{ cm}^4$$

$$= 249.0 \text{ cm}^4$$

Berechnungsformel Trapezlast

Calculation formula trapezoidal load

$$I_{xT} = \frac{p_w \cdot L_T^4}{1920 \cdot E \cdot f_{zul./adm.}} \cdot \left(25 - 40 \frac{a^2}{L_T^2} + 16 \frac{a^4}{L_T^4} \right)$$

Windsog angenommen* / Wind suction assumed*

$$= -1.12 \text{ kN/m}^2$$

$$\text{erf. / requ. } I_x = w_e \cdot I_D = (-1.12) \cdot 389 \text{ cm}^4$$

$$= 435.7 \text{ cm}^4$$

Statisches System Dreiecklast

Statical system triangular load

Träger auf 2 Stützen / Beam on 2 supports

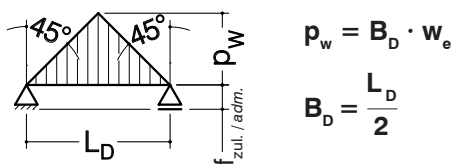

$$p_w = B_D \cdot w_e$$

$$B_D = \frac{L_D}{2}$$

Berechnungsformel Dreiecklast

Calculation formula triangular load

$$I_{xD} = \frac{p_w \cdot L^4}{120 \cdot E \cdot f_{zul./adm.}}$$

I_x (cm⁴) = Trägheitsmoment / Moment of inertia

I_D (cm⁴) = Trägheitsmoment, Rechtecklast / Moment of inertia, rectangular load

L_D (cm) = Stützweite Dreiecklast / Bearing span triangular load

L_T (cm) = Stützweite Trapezlast / Bearing span trapezoidal load

B_D (cm) = Belastungsbreite Dreiecklast / Load width triangular load $B_D = L_D/2$

B_T (cm) = Belastungsbreite Trapezlast / Load width trapezoidal load

w_e (kN/cm²) = Winddruck/Windsog / Wind pressure/-depression

p_w (kN/cm) = Linienlast / Line load

E (kN/cm²) = Elastizitätsmodul / Modulus of elasticity $7 \cdot 10^3$

$f_{zul./adm.}$ (cm) = zul. Durchbiegung / adm. deflection

$$f_{zul. / adm.} = L / 300 \text{ max. } 8 \text{ mm}$$

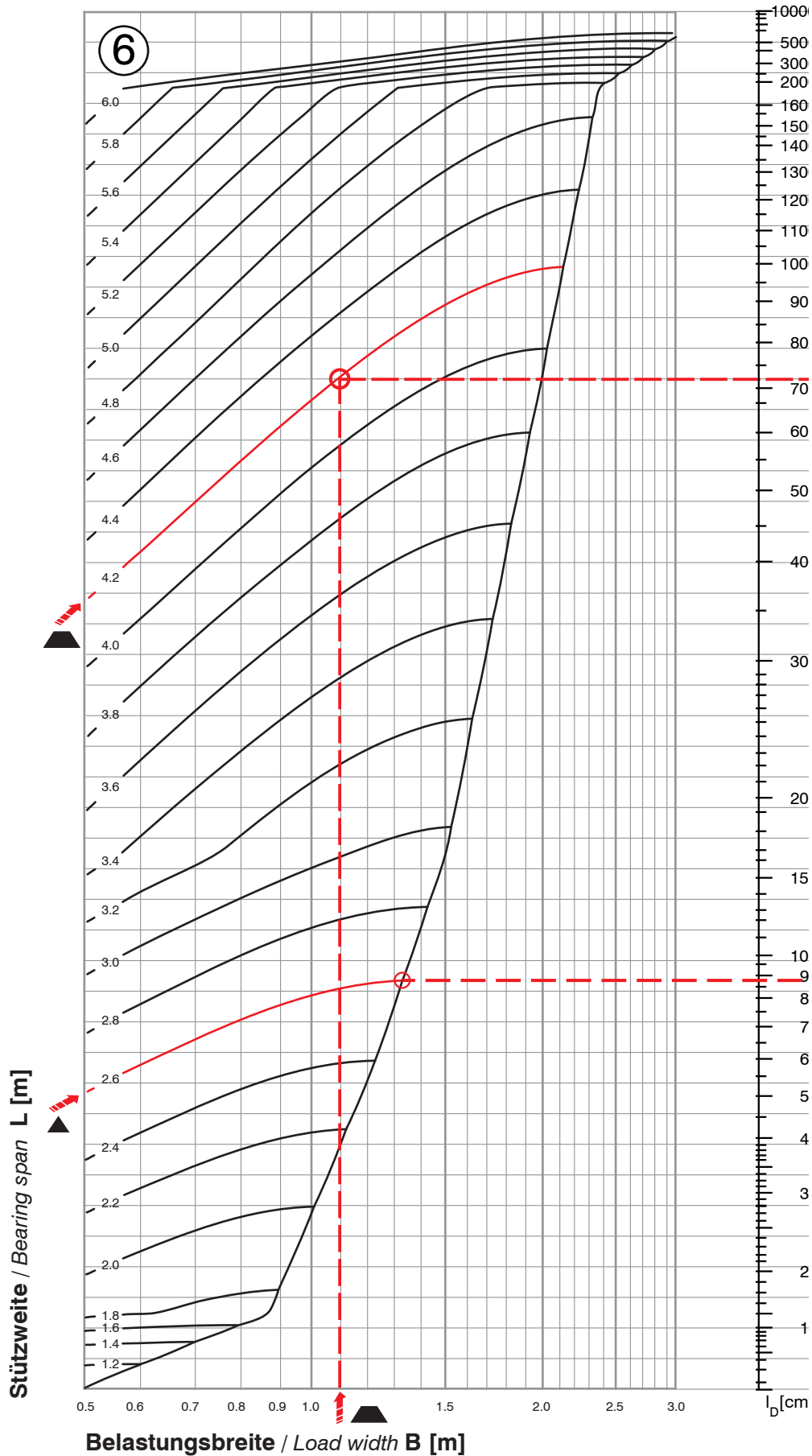

Dreieck- und Trapezlast (Einheitslast 1.0 kN/m²)
Triangular and trapezoidal load (Unit load 1.0 kN/m²)

$$f_{zul./adm.} = L / 300 \text{ max. } 8 \text{ mm}$$

System / System

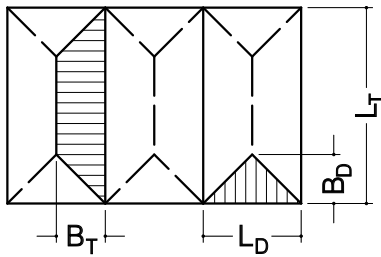

Anwendungsbeispiel Trapezlast

Example of application trapezoidal load

Stützweite / Bearing span:

$$L_T = 4.20 \text{ m}$$

Belastungsbreite / Load width:

$$B_T = 1.10 \text{ m}$$

Rechtecklast / Rectangular load:

$$I_D = 711 \text{ cm}^4 \text{ (} \textcircled{\text{C}} \text{ abgelesen / is read)}$$

Statisches System Trapezlast

Statical system trapezoidal load

Träger auf 2 Stützen / Beam on 2 supports

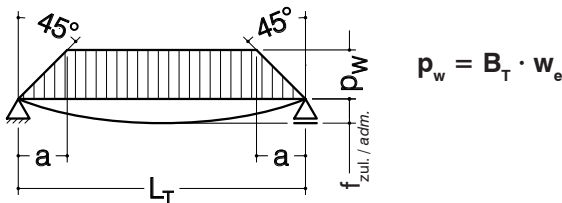

Ermittlung: erf. I_x / Determination: requ. I_x

Beispiel / Example:

Winddruck angenommen* / Wind pressure assumed*

$$= 0.64 \text{ kN/m}^2$$

$$\text{erf. / requ. } I_x = w_e \cdot I_D = 0.64 \cdot 711 \text{ cm}^4$$

$$= 455.0 \text{ cm}^4$$

Berechnungsformel Trapezlast

Calculation formula trapezoidal load

$$I_{xT} = \frac{p_w \cdot L_T^4}{1920 \cdot E \cdot f_{zul./adm.}} \cdot \left(25 - 40 \frac{a^2}{L_T^2} + 16 \frac{a^4}{L_T^4} \right)$$

Windsog angenommen* / Wind suction assumed*

$$= -1.12 \text{ kN/m}^2$$

$$\text{erf. / requ. } I_x = w_e \cdot I_D = (-1.12) \cdot 711 \text{ cm}^4$$

$$= 796.3 \text{ cm}^4$$

Statisches System Dreiecklast

Statical system triangular load

Träger auf 2 Stützen / Beam on 2 supports

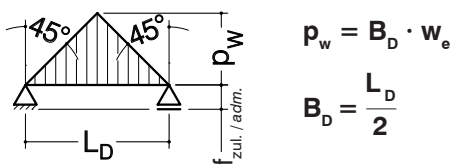

Berechnungsformel Dreiecklast

Calculation formula triangular load

$$I_{xD} = \frac{p_w \cdot L^4}{120 \cdot E \cdot f_{zul./adm.}}$$

I_x (cm⁴) = Trägheitsmoment / Moment of inertia

I_D (cm⁴) = Trägheitsmoment, Rechtecklast / Moment of inertia, rectangular load

L_D (cm) = Stützweite Dreiecklast / Bearing span triangular load

L_T (cm) = Stützweite Trapezlast / Bearing span trapezoidal load

B_D (cm) = Belastungsbreite Dreiecklast / Load width triangular load B_D = L_D/2

B_T (cm) = Belastungsbreite Trapezlast / Load width trapezoidal load

w_e (kN/cm²) = Winddruck/Windsog / Wind pressure/-depression

p_w (kN/cm) = Linienlast / Line load

E (kN/cm²) = Elastizitätsmodul / Modulus of elasticity 7 · 10³

f_{zul./adm.} (cm) = zul. Durchbiegung / adm. deflection

Glaslast (0.15 / 0.30 / 0.45 kN/m²)

Glass load (0.15 / 0.30 / 0.45 kN/m²)

$f_{zul. / adm.} = 3 \text{ mm}$

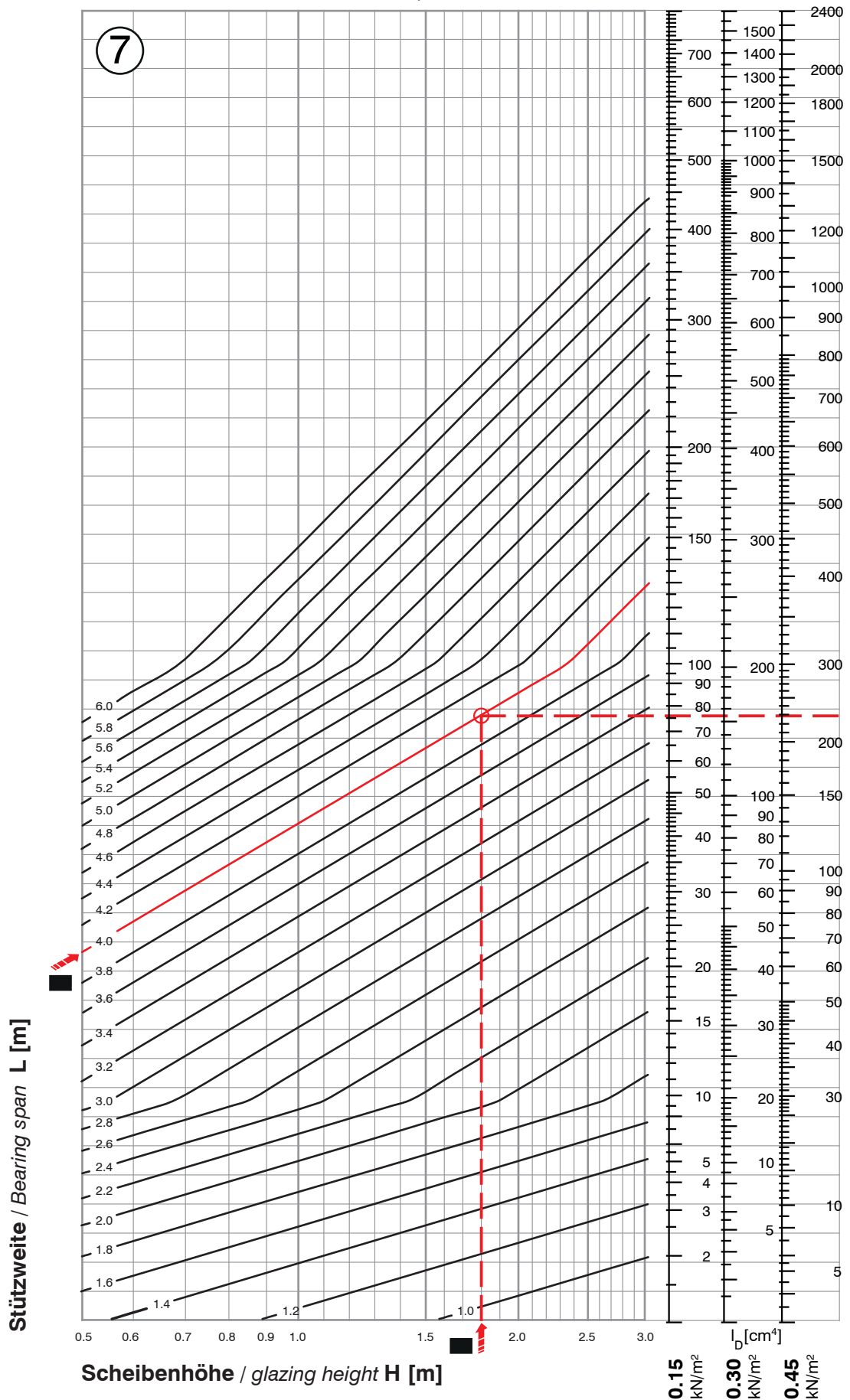

Glaslast (0.15 / 0.30 / 0.45 kN/m²)
Glass load (0.15 / 0.30 / 0.45 kN/m²)

$$f_{\text{zul. / adm.}} = 3 \text{ mm}$$

System / System

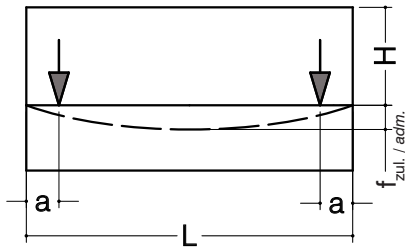

Das Eigengewicht des Profils ist nicht berücksichtigt!
The dead weight of the profile is not considered!

Anwendungsbeispiel Rechtecklast Example of application rectangular load

Stützweite / Bearing span:

$$L_T = 4.00 \text{ m}$$

Scheibenhöhe / Glazing height:

$$H = 1.80 \text{ m}$$

Statisches System Statical system

Träger auf 2 Stützen / Beam on 2 supports

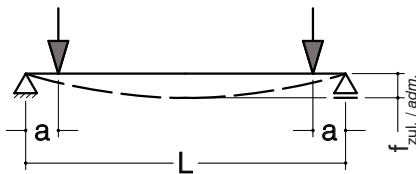

$$F = \frac{H \cdot L}{2} \cdot q_G$$

a = 150 mm festgelegt / fixed

Beispiel / Example:

bei / for q_G 0.15 kN/m²

$$I_y = 77 \text{ cm}^4 \text{ (⊗ abgelesen / is read)}$$

bei / for q_G 0.30 kN/m²

$$I_y = 154 \text{ cm}^4 \text{ (⊗ abgelesen / is read)}$$

bei / for q_G 0.45 kN/m²

$$I_y = 231 \text{ cm}^4 \text{ (⊗ abgelesen / is read)}$$

Berechnungsformel Glaslast Calculation formula glass load

Calculation formula glass load

$$I_y = \frac{F \cdot a}{24 \cdot E \cdot f_{\text{zul. / adm.}}} \cdot (3 \cdot L^2 - 4 a^2)$$

- I_y (cm⁴) = Trägheitsmoment / Moment of inertia
- $F(P)$ (kN) = Einzellast / Single load
- a (cm) = Klotzungsabstand / Shimming distance
- H (cm) = Scheibenhöhe / Pane height
- L (cm) = Stützweite / Bearing span
- q_G (kN/cm²) = Glasgewicht / Glass weight
- $f_{\text{zul. / adm.}}$ (cm) = zul. Durchbiegung / adm. deflection

Regelwerke und Normen

Neben den Landesbauordnungen und Richtlinien sind die Normen und die VOB für das Metallhandwerk, Verglasungsarbeiten, Bauwesen und Bauphysik auf dem jeweils neuesten Ausgabestand entscheidend.
Es gilt die jeweils aktuelle Bauregelliste.

Eine Auflistung der zutreffenden, wichtigen Normen finden Sie in unserem digitalen technischen Informationsportal

www.wictip.de

Regulations and Standards

Besides the regional building regulations and guidelines, the latest edition of standards and German construction contract procedures (VOB) for metal working, glazing works, civil engineering and building physics are binding.
The respective, current Building Rules List applies.

A list of relevant, important standards can be found in our digital technical information portal

www.wictip.de



Glas

Planungshinweise > Normen > Anhang A - Glas

Metallbau

Planungshinweise > Normen > Anhang B - Metallbau

Statik

Planungshinweise > Normen > Anhang C - Static

Verglasungsarbeiten

Planungshinweise > Normen > Anhang D - Verglasungsarbeiten

Wärmeschutz

Planungshinweise > Normen > Anhang E - Wärmeschutz

Schallschutz

Planungshinweise > Normen > Anhang F - Schallschutz

Sonnenschutz

Planungshinweise > Normen > Anhang G - Sonnenschutz

Sicherheit

Planungshinweise > Normen > Anhang H - Sicherheit

Brandschutz

Planungshinweise > Normen > Anhang I - Brandschutz

Bauwerksabdichtungen

Planungshinweise > Normen > Anhang J - Bauwerksabdichtung

Glass

Planning hints > Standards > Appendix A - Glass

Metal construction

Planning hints > Standards > Appendix B - Metal construction

Statics

Planning hints > Standards > Appendix C - Statics

Glazing works

Planning hints > Standards > Appendix D - Glazing works

Thermal insulation

Planning hints > Standards > Appendix E - Thermal insulation

Sound insulation

Planning hints > Standards > Appendix F - Sound insulation

Solar protection

Planning hints > Standards > Appendix G - Sunshade

Safety

Planning hints > Standards > Appendix H - Safety

Fire protection

Planning hints > Standards > Appendix I - Fire protection

Structural sealing

Planning hints > Standards > Appendix J - Structural sealing

WICSTYLE 75 evo

Blendrahmenprofile
Frame profiles

Statische Werte
Statical values

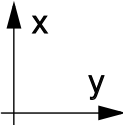
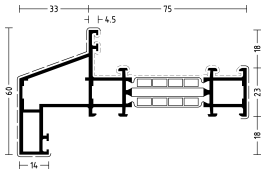
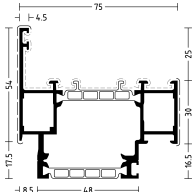
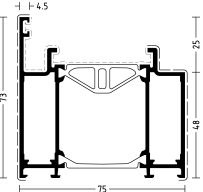
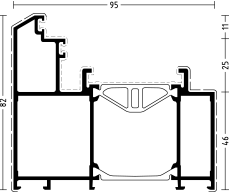
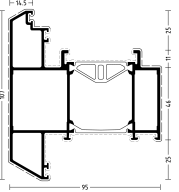
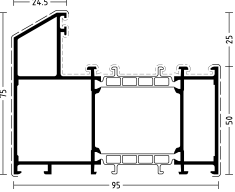
	Artikel-Nr. / Article-no.				
	lx	eff (cm ⁴) nach IfBt-Richtlinien eff (cm ⁴) acc. to IfBt guidelines			
	ly	add (cm ⁴) add (cm ⁴)			
	Stützweite L ab (cm) Bearing span L from (cm)				
	200	250	300	400	
	1010425				
	lx	50.24	56.65	60.87	65.73
	ly	8.91			
	1017077				
	lx	26.91	30.43	32.76	35.47
	ly	14.18			
	1020500				
	lx	36.36	40.93	43.94	47.4
	ly	24.3			
	1020502				
	lx	62.42	70.77	76.31	82.75
	ly	38.77			
	1020503				
	lx	66.28	75.58	81.82	89.13
	ly	64.87			
	1020504				
	lx	46.89	54.86	60.45	67.25
	ly	29.09			

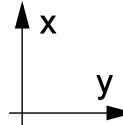
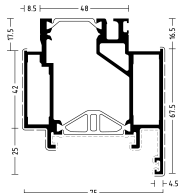
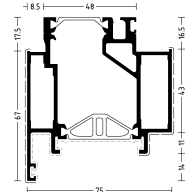
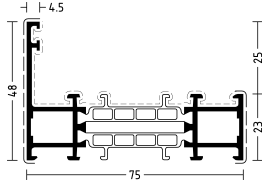
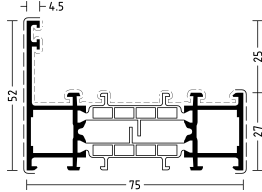
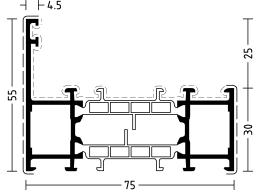
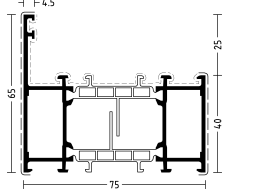
	Artikel-Nr. / Article-no.				
	lx	eff (cm ⁴) nach IfBt-Richtlinien eff (cm ⁴) acc. to IfBt guidelines			
	ly	add (cm ⁴) add (cm ⁴)			
	Stützweite L ab (cm) Bearing span L from (cm)				
	200	250	300	400	
	1020512				
	lx	33.52	39.57	43.87	49.19
	ly	42.53			
	1020513				
	lx	32.78	38.92	43.32	48.81
	ly	40.02			
	1917001				
	lx	21.38	23.88	25.5	27.35
	ly	4.22			
	1917002				
	lx	22.53	25.35	27.19	29.31
	ly	5.56			
	1917003				
	lx	23.5	26.56	28.58	30.92
	ly	6.76			
	1917004				
	lx	26.06	29.85	32.41	35.43
	ly	12.11			

WICSTYLE 75 evo

Blendrahmenprofile
Frame profiles

Statische Werte
Statical values

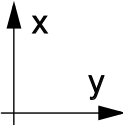
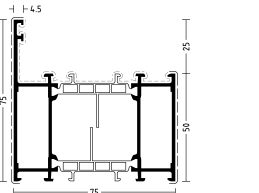
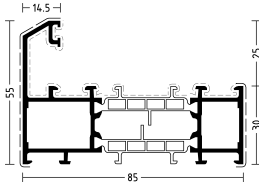
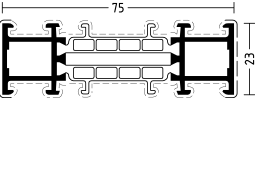
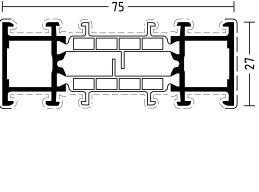
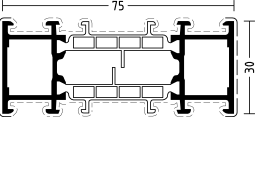
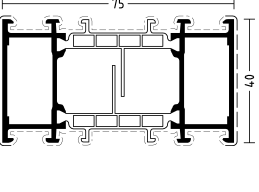
		Artikel-Nr. / Article-no.				
		lx	eff (cm ⁴) nach IfBt-Richtlinien eff (cm ⁴) acc. to IfBt guidelines			
		ly	add (cm ⁴) add (cm ⁴)			
		Stützweite L ab (cm) Bearing span L from (cm)				
			200	250	300	400
	1917005	lx	28.37	32.9	36.02	39.77
	ly	19.77				
	1917009	lx	31.33	35.64	38.52	41.89
	ly	8.96				
	1917055	lx	17.91	19.78	20.97	22.3
	ly	1.37				
	1917056	lx	19.15	21.3	22.69	24.25
	ly	2.22				
	1917057	lx	20.18	22.57	24.11	25.87
	ly	3.03				
	1917058	lx	22.94	26.01	28.05	30.42
	ly	6.91				

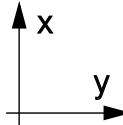
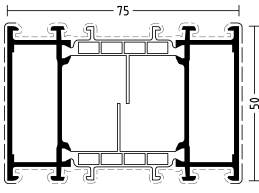
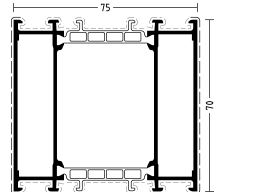
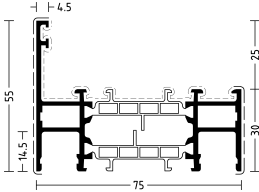
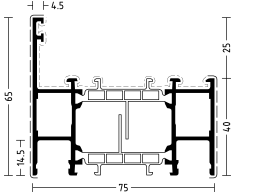
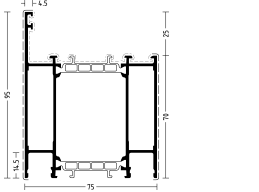
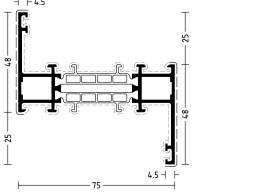
		Artikel-Nr. / Article-no.				
		lx	eff (cm ⁴) nach IfBt-Richtlinien eff (cm ⁴) acc. to IfBt guidelines			
		ly	add (cm ⁴) add (cm ⁴)			
		Stützweite L ab (cm) Bearing span L from (cm)				
			200	250	300	400
	1917059	lx	25.44	29.22	31.79	34.83
	ly	12.85				
	1917060	lx	29.8	35.02	38.71	43.23
	ly	32.13				
	1917062	lx	23.85	27.04	29.16	31.63
	ly	6.04				
	1917064	lx	26.41	30.35	33.03	36.21
	ly	11.07				
	1917067	lx	32.62	38.76	43.18	48.7
	ly	41.77				
	1917068	lx	25.65	29.07	31.34	33.98
	ly	7.07				

WICSTYLE 75 evo

Blendrahmenprofile
Frame profiles

Statische Werte
Statical values

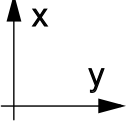
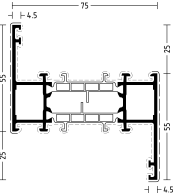
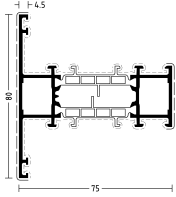
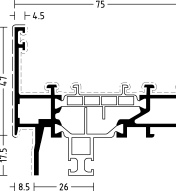
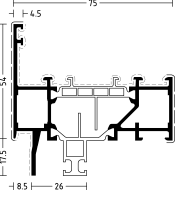
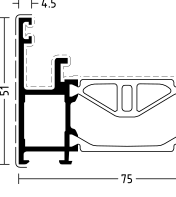
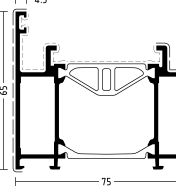
		Artikel-Nr. / Article-no.				
		lx	eff (cm ⁴) nach IfBt-Richtlinien eff (cm ⁴) acc. to IfBt guidelines			
		ly	add (cm ⁴) add (cm ⁴)			
		Stützweite L ab (cm) Bearing span L from (cm)				
		200 250 300 400				
		1917069				
		lx	27.44	31.42	34.12	37.3
		ly	10.5			
		1917073				
		lx	25.87	29.48	31.89	34.72
		ly	12.61			
		1917076				
		lx	23.62	26.36	28.12	30.14
		ly	6.69			
		1917077				
		lx	25.79	29.01	31.12	33.54
		ly	10.13			
		1927500				
		lx	26.3	29.47	31.54	33.91
		ly	6.94			
		1927501				
		lx	30.74	35.07	37.97	41.38
		ly	16.13			

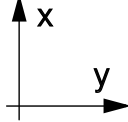
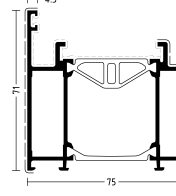
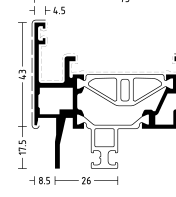
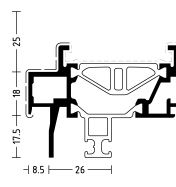
		Artikel-Nr. / Article-no.				
		lx	eff (cm ⁴) nach IfBt-Richtlinien eff (cm ⁴) acc. to IfBt guidelines			
		ly	add (cm ⁴) add (cm ⁴)			
		Stützweite L ab (cm) Bearing span L from (cm)				
		200 250 300 400				
		1927502				
		lx	32.48	37.31	40.59	44.47
		ly	21.69			
		1927506				
		lx	24.05	27.2	29.27	31.68
		ly	6.75			
		1927507				
		lx	25.12	28.43	30.62	33.17
		ly	6.3			

WICSTYLE 75 evo

Sockelprofile
Bottom rail profiles

Statische Werte
Statical values

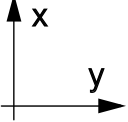
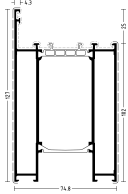
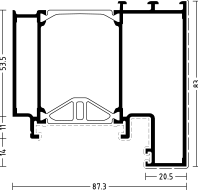
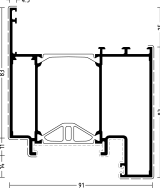
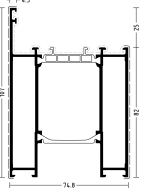
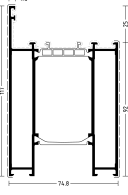
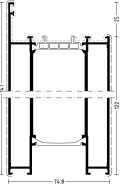
		Artikel-Nr. / Article-no.				
		lx	eff (cm ⁴) nach IfBt-Richtlinien eff (cm ⁴) acc. to IfBt guidelines			
		ly	add (cm ⁴) add (cm ⁴)			
		Stützweite L ab (cm) Bearing span L from (cm)				
			200	250	300	400
		1020508				
		lx	49.38	58.03	64.13	71.62
		ly	112.48			
		1020533				
		lx	53.52	60.63	65.34	70.81
		ly	46.88			
		1020534				
		lx	64.23	74	80.66	88.59
		ly	60.2			
		1927516				
		lx	44.37	51.17	55.82	61.37
		ly	63.8			
		1927517				
		lx	42.23	50.5	56.51	64.09
		ly	85.96			
		1927518				
		lx	47.53	58.47	66.84	77.92
		ly	182.43			

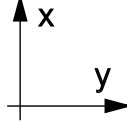
		Artikel-Nr. / Article-no.				
		lx	eff (cm ⁴) nach IfBt-Richtlinien eff (cm ⁴) acc. to IfBt guidelines			
		ly	add (cm ⁴) add (cm ⁴)			
		Stützweite L ab (cm) Bearing span L from (cm)				
			200	250	300	400

WICSTYLE 75 evo

Flügelprofile
Sash profiles

Statische Werte
Statical values

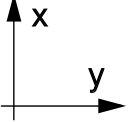
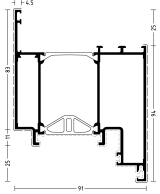
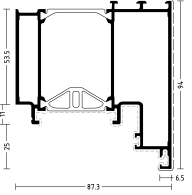
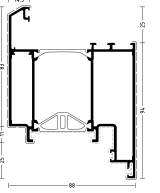
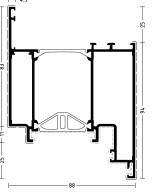
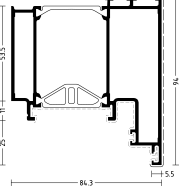
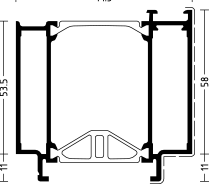
	Artikel-Nr. / Article-no.				
	lx	eff (cm ⁴) nach IfBt-Richtlinien eff (cm ⁴) acc. to IfBt guidelines			
	ly	add (cm ⁴) add (cm ⁴)			
	Stützweite L ab (cm) Bearing span L from (cm)				
	200	250	300	400	
	1020461				
lx	67.3	77.75	84.91	93.46	
ly	67.54				
	1020501				
lx	56.14	63.73	68.78	74.66	
ly	54.22				
	1020510				
lx	63.01	73.03	79.94	88.25	
ly	69.71				
	1020511				
lx	62.76	72.5	79.17	87.15	
ly	65.23				
	1020515				
lx	52.02	59.07	63.77	69.25	
ly	51.91				
	1320033				
lx	31.77	35.67	38.21	41.14	
ly	25.52				

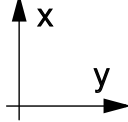
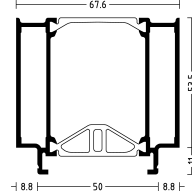
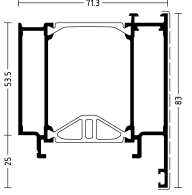
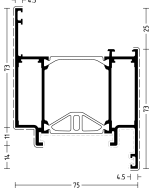
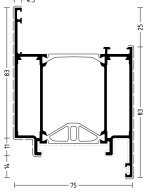
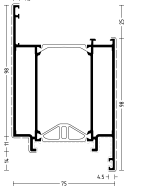
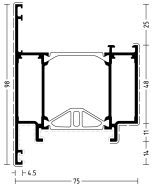
	Artikel-Nr. / Article-no.				
	lx	eff (cm ⁴) nach IfBt-Richtlinien eff (cm ⁴) acc. to IfBt guidelines			
	ly	add (cm ⁴) add (cm ⁴)			
	Stützweite L ab (cm) Bearing span L from (cm)				
	200	250	300	400	
	1920513				
lx	25.73	29.39	31.86	34.76	
ly	21.67				
	1920517				
lx	31.93	36.92	40.34	44.43	
ly	33.01				
	1927510				
lx	36.86	42.79	46.89	51.84	
ly	31.85				
	1927511				
lx	39.24	46.03	50.8	56.64	
ly	46.34				
	1927512				
lx	42.93	51.18	57.15	64.65	
ly	75.32				
	1927513				
lx	35.9	41.6	45.52	50.22	
ly	34.02				

WICSTYLE 75 evo

Flügelprofile
Sash profiles

Statische Werte
Statical values

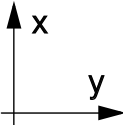
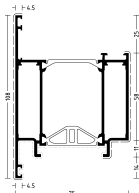
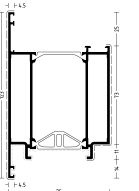
Artikel-Nr. / Article-no.									
	<table border="1"> <tr> <td>lx</td> <td>eff (cm⁴) nach IfBt-Richtlinien eff (cm⁴) acc. to IfBt guidelines</td> </tr> <tr> <td>ly</td> <td>add (cm⁴) add (cm⁴)</td> </tr> <tr> <td colspan="2"> Stützweite L ab (cm) Bearing span L from (cm) </td> </tr> <tr> <td></td> <td>200 250 300 400</td> </tr> </table>	lx	eff (cm ⁴) nach IfBt-Richtlinien eff (cm ⁴) acc. to IfBt guidelines	ly	add (cm ⁴) add (cm ⁴)	Stützweite L ab (cm) Bearing span L from (cm)			200 250 300 400
	lx	eff (cm ⁴) nach IfBt-Richtlinien eff (cm ⁴) acc. to IfBt guidelines							
ly	add (cm ⁴) add (cm ⁴)								
Stützweite L ab (cm) Bearing span L from (cm)									
	200 250 300 400								
									
1927514									
lx	38.44 45.01 49.61 55.23								
ly	48.83								
									
1927515									
lx	42.3 50.37 56.19 63.48								
ly	78.22								

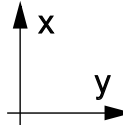
Artikel-Nr. / Article-no.									
	<table border="1"> <tr> <td>lx</td> <td>eff (cm⁴) nach IfBt-Richtlinien eff (cm⁴) acc. to IfBt guidelines</td> </tr> <tr> <td>ly</td> <td>add (cm⁴) add (cm⁴)</td> </tr> <tr> <td colspan="2"> Stützweite L ab (cm) Bearing span L from (cm) </td> </tr> <tr> <td></td> <td>200 250 300 400</td> </tr> </table>	lx	eff (cm ⁴) nach IfBt-Richtlinien eff (cm ⁴) acc. to IfBt guidelines	ly	add (cm ⁴) add (cm ⁴)	Stützweite L ab (cm) Bearing span L from (cm)			200 250 300 400
	lx	eff (cm ⁴) nach IfBt-Richtlinien eff (cm ⁴) acc. to IfBt guidelines							
ly	add (cm ⁴) add (cm ⁴)								
Stützweite L ab (cm) Bearing span L from (cm)									
	200 250 300 400								

WICSTYLE 75 evo

Kämpfer, Sprossenprofile
Transom, glazing bar profiles

Statische Werte
Statical values

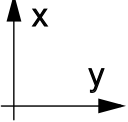
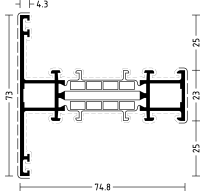
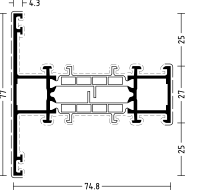
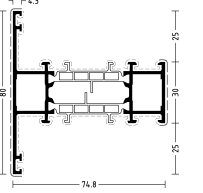
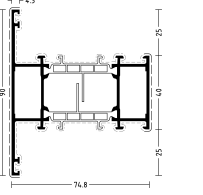
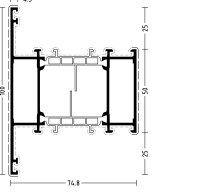
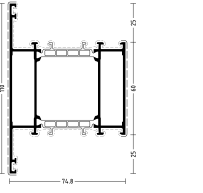
	Artikel-Nr. / Article-no.				
	lx	eff (cm ⁴) nach lFBt-Richtlinien eff (cm ⁴) acc. to lFBt guidelines			
	ly	add (cm ⁴) add (cm ⁴)			
		Stützweite L ab (cm) Bearing span L from (cm)			
		200	250	300	400
	1917201				
	lx	25.14	27.74	29.39	31.24
	ly	8.52			
	1917202				
	lx	26.11	29.1	31.03	33.22
	ly	10.45			
	1917203				
	lx	25.56	29.1	31.47	34.24
	ly	12.13			
	1917204				
	lx	28.05	32.36	35.31	38.82
	ly	19.2			
	1917205				
	lx	30.28	35.35	38.89	43.19
	ly	28.84			
	1917206				
	lx	32.3	38.12	42.26	47.38
	ly	41.33			

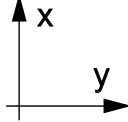
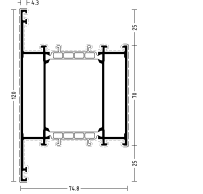
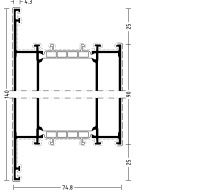
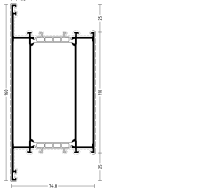
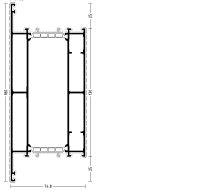
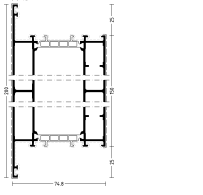
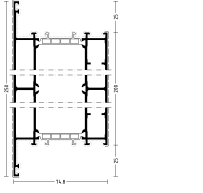
	Artikel-Nr. / Article-no.				
	lx	eff (cm ⁴) nach lFBt-Richtlinien eff (cm ⁴) acc. to lFBt guidelines			
	ly	add (cm ⁴) add (cm ⁴)			
		Stützweite L ab (cm) Bearing span L from (cm)			
		200	250	300	400
	1917207				
	lx	34.13	40.69	45.44	51.41
	ly	57			
	1917209				
	lx	37.94	46.24	52.47	60.6
	ly	100.21			
	1917211				
	lx	40.72	50.45	57.97	68.05
	ly	160			
	1917213				
	lx	44.45	56.48	66.21	79.91
	ly	246.21			
	1917215				
	lx	46.73	60.15	71.27	87.32
	ly	353.75			
	1917220				
	lx	51.2	67.9	82.53	105.02
	ly	769.17			

WICSTYLE 75 evo

Kämpfer, Sprossenprofile

Transom, glazing bar profiles

Statische Werte

Statical values

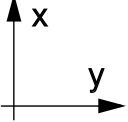
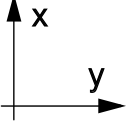
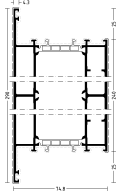
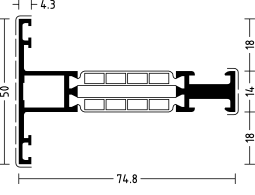
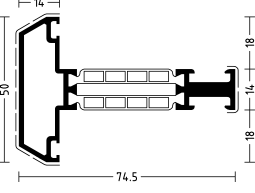
		Artikel-Nr. / Article-no.				
		lx	eff (cm ⁴) nach IfBt-Richtlinien eff (cm ⁴) acc. to IfBt guidelines			
		ly	add (cm ⁴) add (cm ⁴)			
		Stützweite L ab (cm) Bearing span L from (cm)				
			200	250	300	400
		1917224				
		lx	55.02	74.41	92.03	120.36
		ly	1281.31			
		1917336				
		lx	22.41	24.5	25.81	27.25
		ly	2.93			
		1917338				
		lx	21.78	23.94	25.3	26.82
		ly	5.09			

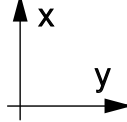
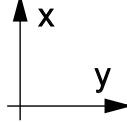
		Artikel-Nr. / Article-no.				
		lx	eff (cm ⁴) nach IfBt-Richtlinien eff (cm ⁴) acc. to IfBt guidelines			
		ly	add (cm ⁴) add (cm ⁴)			
		Stützweite L ab (cm) Bearing span L from (cm)				
			200	250	300	400

WICSTYLE 75 evo

Stützenprofile
Mullion profiles for windows

Statische Werte
Statical values

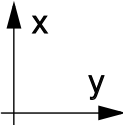
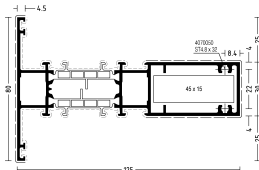
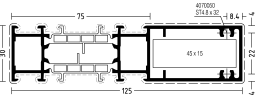
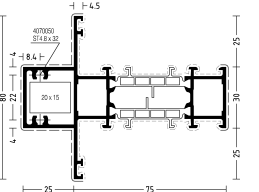
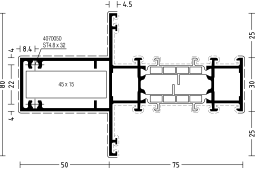
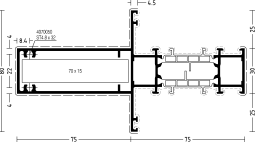
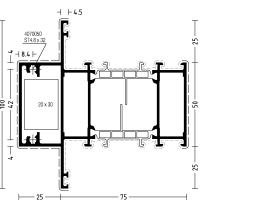
		Artikel-Nr. / Article-no.				
		lx	eff (cm ⁴) nach IfBt-Richtlinien eff (cm ⁴) acc. to IfBt guidelines			
		ly	add (cm ⁴) add (cm ⁴)			
		Stützweite L ab (cm) Bearing span L from (cm)				
			200	250	300	400
	1917241	lx	85.63	100.87	111.66	124.95
	ly	17.1				
	1917244	lx	72.42	82.04	88.41	95.82
	ly	7.52				
	1917246	lx	42.74	49.04	53.3	58.34
	ly	15.14				
	1917247	lx	72.02	81.78	88.27	95.84
	ly	17.1				
	1917248	lx	118.83	133.3	142.74	153.55
	ly	18.89				
	1917249	lx	51.92	61.22	67.82	75.96
	ly	38.42				

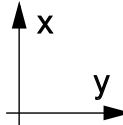
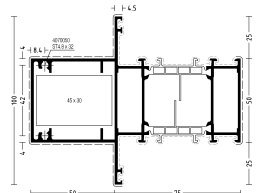
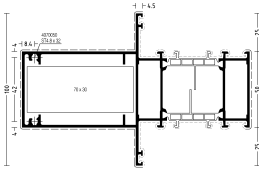
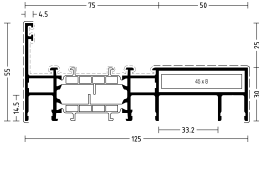
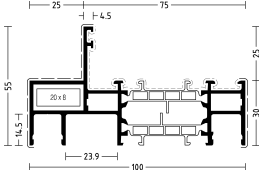
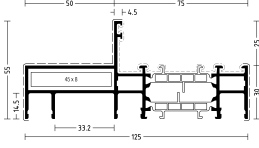
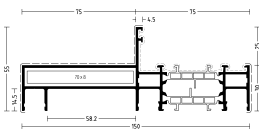
		Artikel-Nr. / Article-no.				
		lx	eff (cm ⁴) nach IfBt-Richtlinien eff (cm ⁴) acc. to IfBt guidelines			
		ly	add (cm ⁴) add (cm ⁴)			
		Stützweite L ab (cm) Bearing span L from (cm)				
			200	250	300	400
	1917250	lx	86.92	101.38	111.45	123.66
	ly	44.46				
	1917251	lx	141.78	163.25	177.88	195.29
	ly	49.69				
	1917256	lx	77.16	89.42	97.87	108.03
	ly	8.04				
	1917258	lx	41.05	46.95	50.92	55.61
	ly	6.97				
	1917259	lx	69.81	79.39	85.79	93.26
	ly	8.09				
	1917260	lx	114.51	128.99	138.5	149.45
	ly	8.53				

WICSTYLE 75 evo

Stützenprofile

Mullion profiles for windows

Statische Werte

Statical values

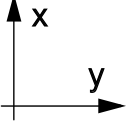
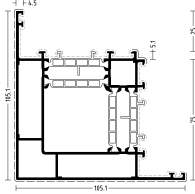
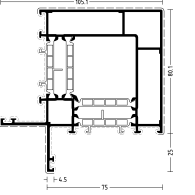
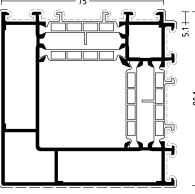
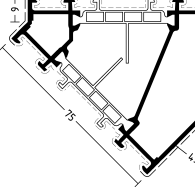
		Artikel-Nr. / Article-no.				
		lx	eff (cm ⁴) nach IfBt-Richtlinien eff (cm ⁴) acc. to IfBt guidelines			
		ly	add (cm ⁴) add (cm ⁴)			
		Stützweite L ab (cm) Bearing span L from (cm)				
			200	250	300	400
		1917270				
		lx	66.84	66.84	66.84	77.64
		ly	68.47			
		1917271				
		lx	58.39	66.52	70.88	75.82
		ly	66.63			
		1917272				
		lx	51.27	54.5	56.43	58.5
		ly	49.11			
		1917273				
		lx	24	26.46	28.02	29.77
		ly	14.25			

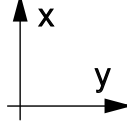
		Artikel-Nr. / Article-no.				
		lx	eff (cm ⁴) nach IfBt-Richtlinien eff (cm ⁴) acc. to IfBt guidelines			
		ly	add (cm ⁴) add (cm ⁴)			
		Stützweite L ab (cm) Bearing span L from (cm)				
			200	250	300	400
		lx	66.84	66.84	66.84	77.64
		ly	68.47			

WICSTYLE 75 evo

Schwellenprofile
Threshold profiles

Statische Werte
Statical values

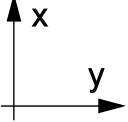
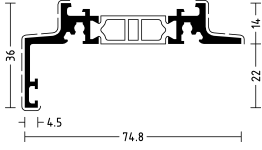
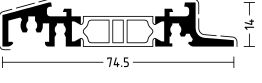
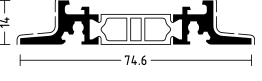
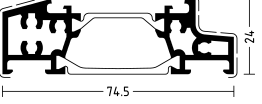
		Artikel-Nr. / Article-no.				
		lx	eff (cm ⁴) nach IfBt-Richtlinien eff (cm ⁴) acc. to IfBt guidelines			
		ly	add (cm ⁴) add (cm ⁴)			
		Stützweite L ab (cm) Bearing span L from (cm)				
			200	250	300	400
		1020496				
		lx	12.17	13.86	14.99	16.32
		ly	1.63			
		1927524				
		lx	10.64	12.05	12.99	14.08
		ly	0.37			
		1927525				
		lx	9.02	10.14	10.88	11.72
		ly	0.37			
		1927526				
		lx	20.17	22.43	23.88	25.53
		ly	1.78			

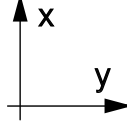
		Artikel-Nr. / Article-no.				
		lx	eff (cm ⁴) nach IfBt-Richtlinien eff (cm ⁴) acc. to IfBt guidelines			
		ly	add (cm ⁴) add (cm ⁴)			
		Stützweite L ab (cm) Bearing span L from (cm)				
			200	250	300	400

WICSTYLE 75 evo

Aufsatzprofile
Supplementary profiles

Statische Werte
Statical values

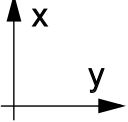
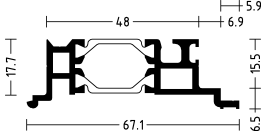
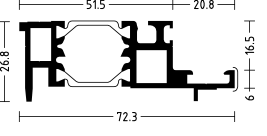
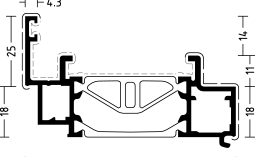
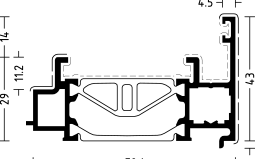
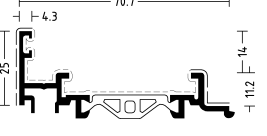
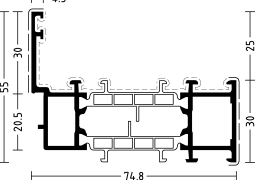
	Artikel-Nr. / Article-no.				
	lx	eff (cm ⁴) nach IfBt-Richtlinien eff (cm ⁴) acc. to IfBt guidelines			
	ly	add (cm ⁴) add (cm ⁴)			
	Stützweite L ab (cm) Bearing span L from (cm)				
	200	250	300	400	
	1010463				
lx	9.45	10.2	10.66	11.17	
ly	1.15				
	1010464				
lx	14.02	15.4	16.27	17.23	
ly	2.25				
	1020442				
lx	22.98	24.9	26.09	27.39	
ly	3.72				
	1020497				
lx	20.98	22.65	23.67	24.77	
ly	4				
	1020498				
lx	13.31	13.98	14.36	14.77	
ly	0.92				
	1917301				
lx	21.78	24.5	26.28	28.33	
ly	5.46				

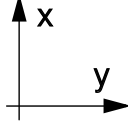
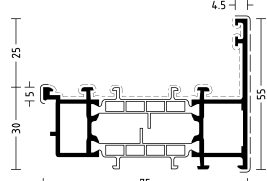
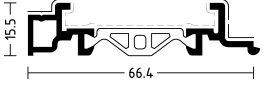
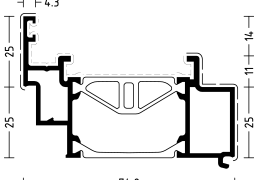
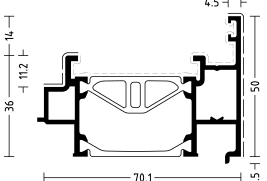
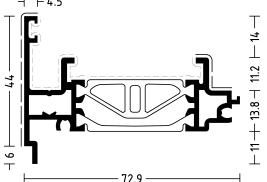
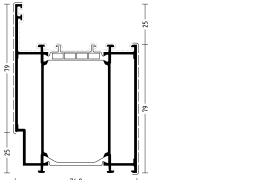
	Artikel-Nr. / Article-no.				
	lx	eff (cm ⁴) nach IfBt-Richtlinien eff (cm ⁴) acc. to IfBt guidelines			
	ly	add (cm ⁴) add (cm ⁴)			
	Stützweite L ab (cm) Bearing span L from (cm)				
	200	250	300	400	
	1917303				
lx	20.76	23.27	24.91	26.78	
ly	6.26				
	1927520				
lx	9.44	9.99	10.31	10.66	
ly	0.33				
	1927521				
lx	22.73	25.21	26.79	28.58	
ly	5.74				
	1927522				
lx	20.48	22.6	23.94	25.45	
ly	5.95				
	1927523				
lx	19.89	21.83	23.05	24.41	
ly	3.67				
	1927527				
lx	36.93	43.15	47.5	52.78	
ly	54.9				

WICSTYLE 75 evo

Aufsatzprofile
Supplementary profiles

Statische Werte
Statical values

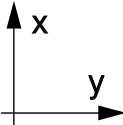
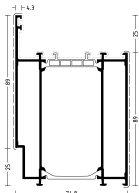
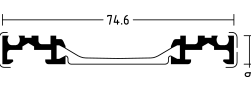
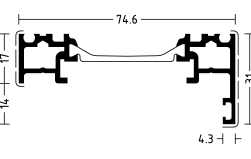
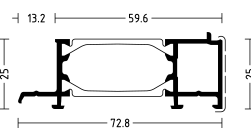
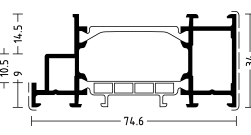
	Artikel-Nr. / Article-no.				
	lx	eff (cm ⁴) nach IfBt-Richtlinien eff (cm ⁴) acc. to IfBt guidelines			
	ly	add (cm ⁴) add (cm ⁴)			
		Stützweite L ab (cm) Bearing span L from (cm)			
		200	250	300	400
	1927528				
	lx	39.04	46.02	50.98	57.09
	ly	74.2			
	1927529				
	lx	10.67	11.19	11.49	11.81
	ly	0.1			
	1927530				
	lx	19.73	21.42	22.46	23.6
	ly	1.45			
	1927531				
	lx	12.77	13.65	14.18	14.75
	ly	1.61			
	1927532				
	lx	19.34	21.2	22.36	23.66
	ly	3.46			

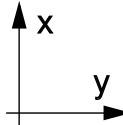
	Artikel-Nr. / Article-no.				
	lx	eff (cm ⁴) nach IfBt-Richtlinien eff (cm ⁴) acc. to IfBt guidelines			
	ly	add (cm ⁴) add (cm ⁴)			
		Stützweite L ab (cm) Bearing span L from (cm)			
		200	250	300	400

WICSTYLE 65 evo / 65

Blendrahmenprofile
Frame profiles

Statische Werte
Statical values

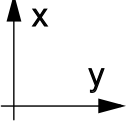
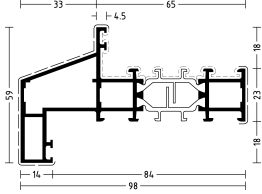
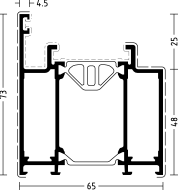
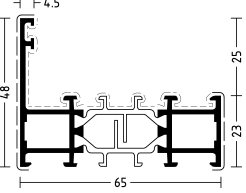
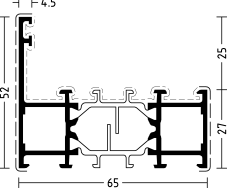
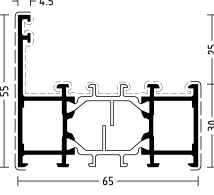
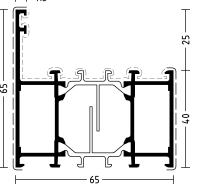
		Artikel-Nr. / Article-no.				
		lx	eff (cm ⁴) nach IfBt-Richtlinien eff (cm ⁴) acc. to IfBt guidelines			
		ly	add (cm ⁴) add (cm ⁴)			
		Stützweite L ab (cm) Bearing span L from (cm)				
			200	250	300	400
		1010187				
		lx	43.41	47.76	50.51	53.58
		ly	8.91			
		1020499				
		lx	23.35	26.89	29.3	32.17
		ly	24.3			
		1916001				
		lx	16.01	17.55	18.51	19.58
		ly	4.22			
		1916002				
		lx	16.93	18.67	19.77	21
		ly	5.56			
		1916003				
		lx	17.72	19.62	20.84	22.2
		ly	6.76			
		1916004				
		lx	19.83	22.22	23.78	25.55
		ly	12.11			

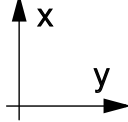
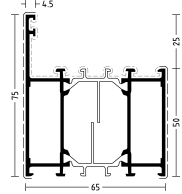
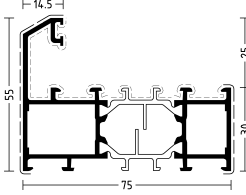
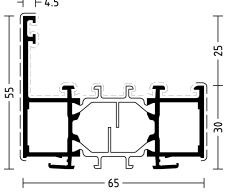
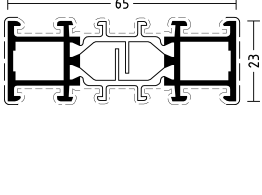
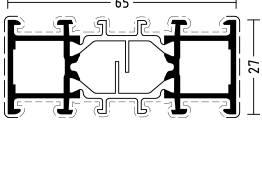
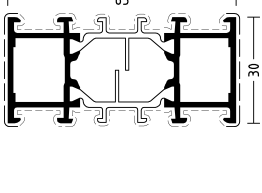
		Artikel-Nr. / Article-no.				
		lx	eff (cm ⁴) nach IfBt-Richtlinien eff (cm ⁴) acc. to IfBt guidelines			
		ly	add (cm ⁴) add (cm ⁴)			
		Stützweite L ab (cm) Bearing span L from (cm)				
			200	250	300	400
		1916005				
		lx	21.77	24.66	26.58	28.8
		ly	19.77			
		1916009				
		lx	24.81	27.62	29.43	31.48
		ly	8.96			
		1916019				
		lx	16.73	18.54	19.69	20.99
		ly	6.61			
		1916055				
		lx	13.14	14.26	14.95	15.7
		ly	1.37			
		1916056				
		lx	14.11	15.41	16.21	17.11
		ly	2.22			
		1916057				
		lx	14.95	16.39	17.3	18.3
		ly	3.03			

WICSTYLE 65 evo / 65

Blendrahmenprofile
Frame profiles

Statische Werte
Statical values

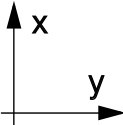
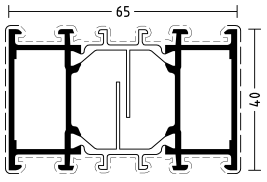
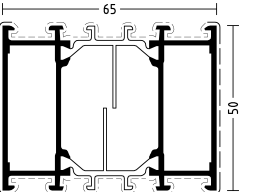
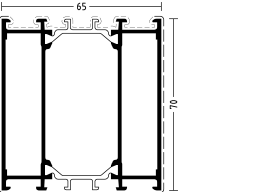
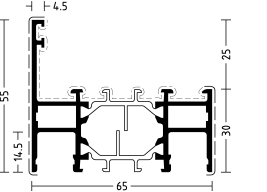
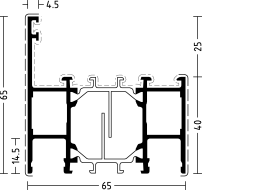
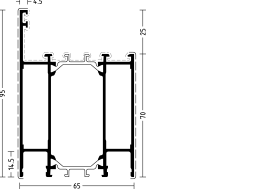
	Artikel-Nr. / Article-no.				
	lx	eff (cm ⁴) nach IfBt-Richtlinien eff (cm ⁴) acc. to IfBt guidelines			
	ly	add (cm ⁴) add (cm ⁴)			
	Stützweite L ab (cm) Bearing span L from (cm)				
	200	250	300	400	
	1916058				
lx	17.19	19.08	20.3	21.67	
ly	6.91				
	1916059				
lx	19.26	21.62	23.17	24.94	
ly	12.85				
	1916060				
lx	22.93	26.29	28.56	31.25	
ly	32.13				
	1916062				
lx	17.99	19.97	21.24	22.68	
ly	6.04				
	1916064				
lx	20.1	22.59	24.22	26.09	
ly	11.07				
	1916067				
lx	25.38	29.41	32.18	35.51	
ly	41.77				

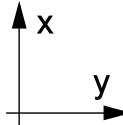
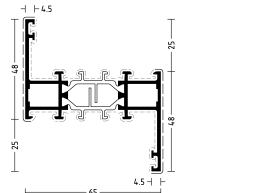
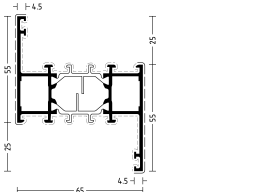
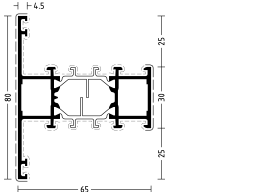
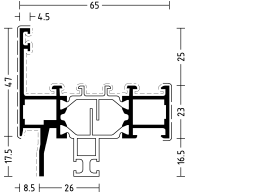
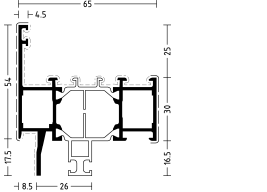
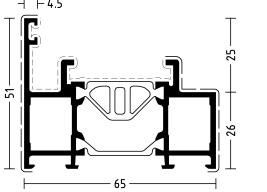
	Artikel-Nr. / Article-no.				
	lx	eff (cm ⁴) nach IfBt-Richtlinien eff (cm ⁴) acc. to IfBt guidelines			
	ly	add (cm ⁴) add (cm ⁴)			
	Stützweite L ab (cm) Bearing span L from (cm)				
	200	250	300	400	
	1916068				
lx	19.59	21.75	23.14	24.7	
ly	7.07				
	1916069				
lx	21.06	23.6	25.26	27.15	
ly	10.5				
	1916073				
lx	19.72	22	23.47	25.14	
ly	12.61				
	1916076				
lx	16.58	18.33	19.45	20.69	
ly	6.58				
	1916077				
lx	18.18	20.26	21.6	23.13	
ly	9.86				
	1926500				
lx	18.38	20.55	21.96	23.56	
ly	6.94				

WICSTYLE 65 evo / 65

Blendrahmenprofile
Frame profiles

Statische Werte
Statical values

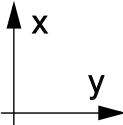
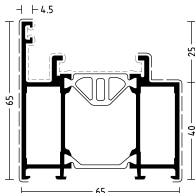
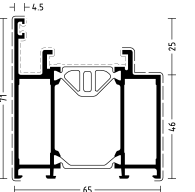
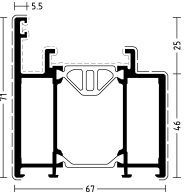
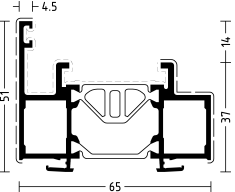
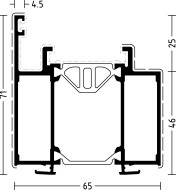
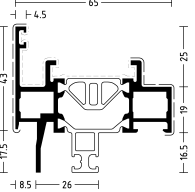
		Artikel-Nr. / Article-no.				
		lx	eff (cm ⁴) nach IfBt-Richtlinien eff (cm ⁴) acc. to IfBt guidelines			
		ly	add (cm ⁴) add (cm ⁴)			
		Stützweite L ab (cm) Bearing span L from (cm)				
			200	250	300	400
		1926501				
		lx	21.61	24.59	26.57	28.89
		ly	16.13			
		1926502				
		lx	22.87	26.2	28.45	31.1
		ly	21.69			
		1926503				
		lx	28.81	33.68	37.09	41.24
		ly	25.59			
		1926504				
		lx	17.1	19.05	20.32	21.75
		ly	6.74			
		1926505				
		lx	21.14	24.07	26.03	28.32
		ly	20.91			
		1926506				
		lx	16.71	18.7	20	21.48
		ly	6.42			

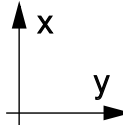
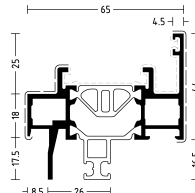
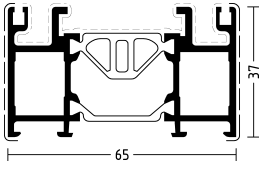
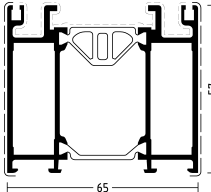
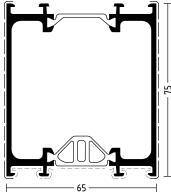
		Artikel-Nr. / Article-no.				
		lx	eff (cm ⁴) nach IfBt-Richtlinien eff (cm ⁴) acc. to IfBt guidelines			
		ly	add (cm ⁴) add (cm ⁴)			
		Stützweite L ab (cm) Bearing span L from (cm)				
			200	250	300	400
		1926507				
		lx	17.55	19.76	21.2	22.86
		ly	5.61			
		1926541				
		lx	19	21.3	22.81	24.53
		ly	5.7			
		1926542				
		lx	23.32	26.78	29.12	31.9
		ly	20.12			
		1926544				
		lx	28.62	33.21	36.38	40.2
		ly	47.08			

WICSTYLE 65 evo / 65

Sockelprofile
Bottom rail profiles

Statische Werte
Statical values

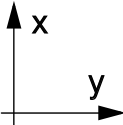
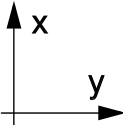
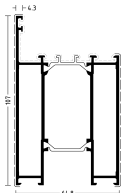
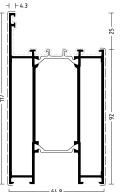
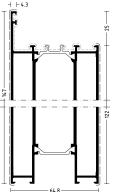
		Artikel-Nr. / Article-no.				
		lx	eff (cm ⁴) nach IfBt-Richtlinien eff (cm ⁴) acc. to IfBt guidelines			
		ly	add (cm ⁴) add (cm ⁴)			
		Stützweite L ab (cm) Bearing span L from (cm)				
			200	250	300	400
		1926516				
		lx	28.54	33.65	37.28	41.75
		ly	63.8			
		1926517				
		lx	30.04	35.8	39.95	45.17
		ly	85.96			
		1926518				
		lx	33.81	41.44	47.23	54.85
		ly	182.43			

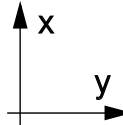
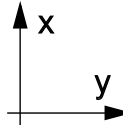
		Artikel-Nr. / Article-no.				
		lx	eff (cm ⁴) nach IfBt-Richtlinien eff (cm ⁴) acc. to IfBt guidelines			
		ly	add (cm ⁴) add (cm ⁴)			
		Stützweite L ab (cm) Bearing span L from (cm)				
			200	250	300	400

WICSTYLE 65 evo / 65

Flügelprofile
Sash profiles

Statische Werte
Statical values

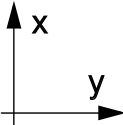
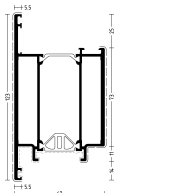
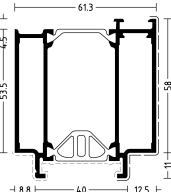
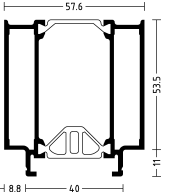
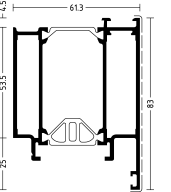
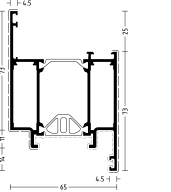
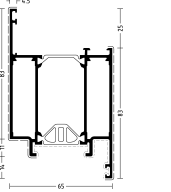
	Artikel-Nr. / Article-no.				
	lx	eff (cm ⁴) nach IfBt-Richtlinien eff (cm ⁴) acc. to IfBt guidelines			
	ly	add (cm ⁴) add (cm ⁴)			
	Stützweite L ab (cm) Bearing span L from (cm)				
	200	250	300	400	
	1020509				
	lx	37.32	45.4	51.45	59.31
	ly	96.91			
	1320034				
	lx	19.98	22.93	24.94	27.31
	ly	25.52			
	1920512				
	lx	17.35	19.77	21.4	23.3
	ly	21.67			
	1920516				
	lx	22.22	25.62	27.94	30.7
	ly	33.01			
	1926510				
	lx	26.24	30.38	33.23	36.65
	ly	31.85			
	1926511				
	lx	27.97	32.72	36.04	40.08
	ly	46.34			

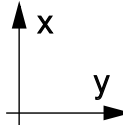
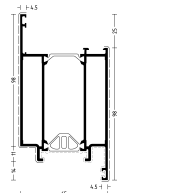
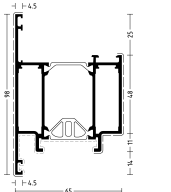
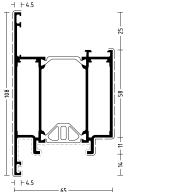
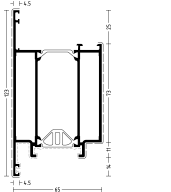
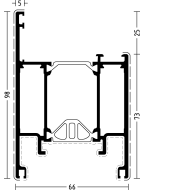
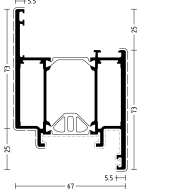
	Artikel-Nr. / Article-no.				
	lx	eff (cm ⁴) nach IfBt-Richtlinien eff (cm ⁴) acc. to IfBt guidelines			
	ly	add (cm ⁴) add (cm ⁴)			
	Stützweite L ab (cm) Bearing span L from (cm)				
	200	250	300	400	
	1926512				
	lx	30.64	36.43	40.58	45.78
	ly	75.32			
	1926513				
	lx	25.5	29.46	32.18	35.43
	ly	34.02			
	1926514				
	lx	27.35	31.93	35.12	39
	ly	48.83			
	1926515				
	lx	30.16	35.8	39.84	44.89
	ly	78.22			
	1926534				
	lx	32.57	38.53	42.77	48.03
	ly	46.14			
	1926535				
	lx	33.42	39.54	43.91	49.33
	ly	38.93			

WICSTYLE 65 evo / 65

Flügelprofile
Sash profiles

Statische Werte
Statical values

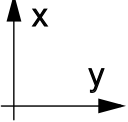
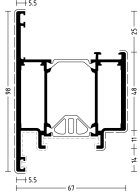
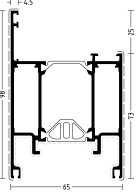
Artikel-Nr. / Article-no.									
	<table border="1"> <tr> <td>lx</td> <td>eff (cm⁴) nach IfBt-Richtlinien eff (cm⁴) acc. to IfBt guidelines</td> </tr> <tr> <td>ly</td> <td>add (cm⁴) add (cm⁴)</td> </tr> <tr> <td colspan="2"> Stützweite L ab (cm) Bearing span L from (cm) </td> </tr> <tr> <td></td> <td>200 250 300 400</td> </tr> </table>	lx	eff (cm ⁴) nach IfBt-Richtlinien eff (cm ⁴) acc. to IfBt guidelines	ly	add (cm ⁴) add (cm ⁴)	Stützweite L ab (cm) Bearing span L from (cm)			200 250 300 400
	lx	eff (cm ⁴) nach IfBt-Richtlinien eff (cm ⁴) acc. to IfBt guidelines							
ly	add (cm ⁴) add (cm ⁴)								
Stützweite L ab (cm) Bearing span L from (cm)									
	200 250 300 400								
									
1926536									
lx	32.26 38.03 42.12 47.17								
ly	42.79								
									
1926540									
lx	28.25 33.08 36.46 40.59								
ly	40.58								

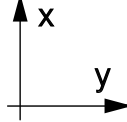
Artikel-Nr. / Article-no.									
	<table border="1"> <tr> <td>lx</td> <td>eff (cm⁴) nach IfBt-Richtlinien eff (cm⁴) acc. to IfBt guidelines</td> </tr> <tr> <td>ly</td> <td>add (cm⁴) add (cm⁴)</td> </tr> <tr> <td colspan="2"> Stützweite L ab (cm) Bearing span L from (cm) </td> </tr> <tr> <td></td> <td>200 250 300 400</td> </tr> </table>	lx	eff (cm ⁴) nach IfBt-Richtlinien eff (cm ⁴) acc. to IfBt guidelines	ly	add (cm ⁴) add (cm ⁴)	Stützweite L ab (cm) Bearing span L from (cm)			200 250 300 400
	lx	eff (cm ⁴) nach IfBt-Richtlinien eff (cm ⁴) acc. to IfBt guidelines							
ly	add (cm ⁴) add (cm ⁴)								
Stützweite L ab (cm) Bearing span L from (cm)									
	200 250 300 400								

WICSTYLE 65 evo / 65

Kämpfer, Sprossenprofile
Transom, glazing bar profiles

Statische Werte
Statical values

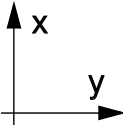
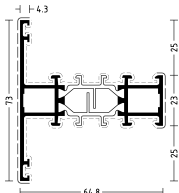
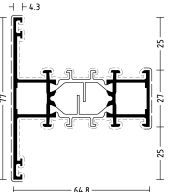
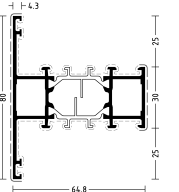
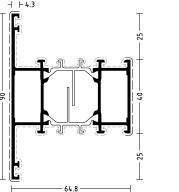
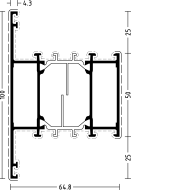
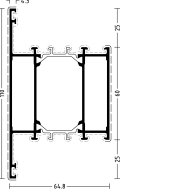
		Artikel-Nr. / Article-no.			
		lx	eff (cm ⁴) nach IfBt-Richtlinien eff (cm ⁴) acc. to IfBt guidelines		
		ly	add (cm ⁴) add (cm ⁴)		
		Stützweite L ab (cm) Bearing span L from (cm)			
		200 250 300 400			
	1916201				
	lx	17.76	19.59	20.75	22.05
	ly	8.52			
	1916202				
	lx	18.68	20.73	22.05	23.53
	ly	10.45			
	1916203				
	lx	19.46	21.69	23.13	24.76
	ly	12.13			
	1916204				
	lx	21.53	24.28	26.09	28.18
	ly	19.2			
	1916205				
	lx	23.41	26.69	28.89	31.47
	ly	28.84			
	1916206				
	lx	25.13	28.94	31.54	34.64
	ly	41.33			

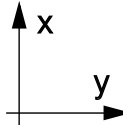
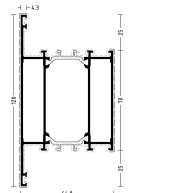
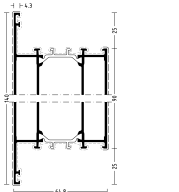
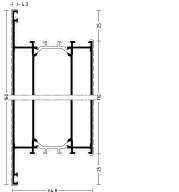
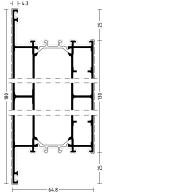
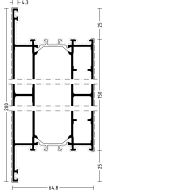
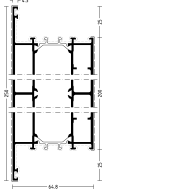
		Artikel-Nr. / Article-no.			
		lx	eff (cm ⁴) nach IfBt-Richtlinien eff (cm ⁴) acc. to IfBt guidelines		
		ly	add (cm ⁴) add (cm ⁴)		
		Stützweite L ab (cm) Bearing span L from (cm)			
		200 250 300 400			
	1916207				
	lx	26.72	31.06	34.07	37.7
	ly	57			
	1916209				
	lx	30.07	35.69	39.72	44.75
	ly	100.21			
	1916211				
	lx	32.58	39.28	44.22	50.54
	ly	160			
	1916213				
	lx	35.97	44.47	51.03	59.78
	ly	246.21			
	1916215				
	lx	38.12	47.75	55.34	65.73
	ly	353.75			
	1916220				
	lx	42.43	54.81	65.14	80.14
	ly	769.17			

WICSTYLE 65 evo / 65

Kämpfer, Sprossenprofile
Transom, glazing bar profiles

Statische Werte
Statical values

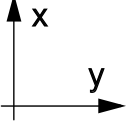
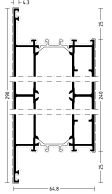
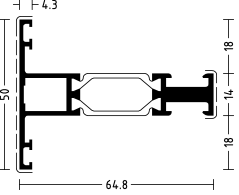
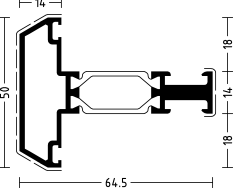
		Artikel-Nr. / Article-no.				
		lx	eff (cm ⁴) nach IfBt-Richtlinien eff (cm ⁴) acc. to IfBt guidelines			
		ly	add (cm ⁴) add (cm ⁴)			
		Stützweite L ab (cm) Bearing span L from (cm)				
			200	250	300	400
		1916224				
		lx	46.18	60.91	73.68	93.08
		ly	1281.31			
		1916336				
		lx	15.83	17.28	18.18	19.18
		ly	2.93			
		1916338				
		lx	14.97	16.48	17.44	18.5
		ly	5.09			

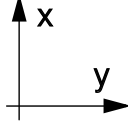
		Artikel-Nr. / Article-no.				
		lx	eff (cm ⁴) nach IfBt-Richtlinien eff (cm ⁴) acc. to IfBt guidelines			
		ly	add (cm ⁴) add (cm ⁴)			
		Stützweite L ab (cm) Bearing span L from (cm)				
			200	250	300	400

WICSTYLE 65 evo / 65

Stützenprofile
Mullion profiles for windows

Statische Werte
Statical values

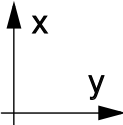
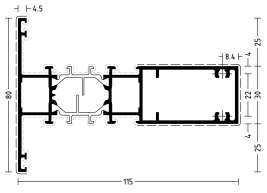
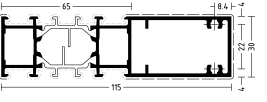
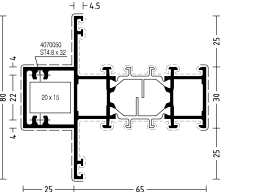
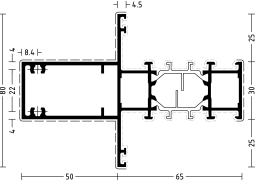
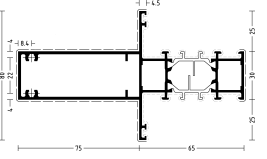
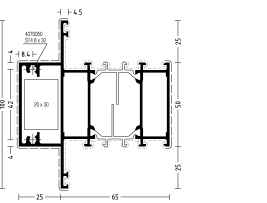
	Artikel-Nr. / Article-no.				
	lx	eff (cm ⁴) nach IfBt-Richtlinien eff (cm ⁴) acc. to IfBt guidelines			
	ly	add (cm ⁴) add (cm ⁴)			
	Stützweite L ab (cm) Bearing span L from (cm)				
	200	250	300	400	
	1916241				
	lx	77.52	88.9	96.61	105.73
	ly	17.1			
	1916244				
	lx	64.99	71.85	76.22	81.13
	ly	7.52			
	1916246				
	lx	35.59	39.87	42.65	45.83
	ly	15.14			
	1916247				
	lx	64.77	71.71	76.13	81.12
	ly	17.1			
	1916248				
	lx	112.22	122.78	129.4	136.73
	ly	18.89			
	1916249				
	lx	44.14	50.68	55.11	60.37
	ly	38.42			

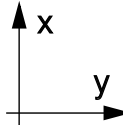
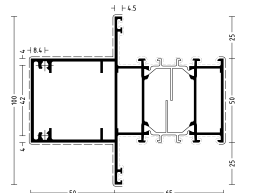
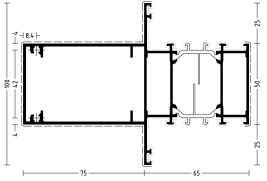
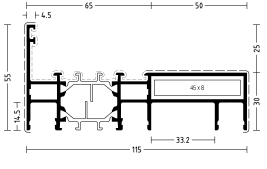
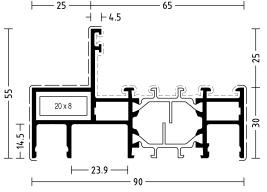
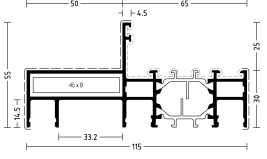
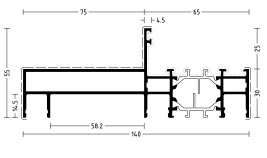
	Artikel-Nr. / Article-no.				
	lx	eff (cm ⁴) nach IfBt-Richtlinien eff (cm ⁴) acc. to IfBt guidelines			
	ly	add (cm ⁴) add (cm ⁴)			
	Stützweite L ab (cm) Bearing span L from (cm)				
	200	250	300	400	
	1916250				
	lx	79.64	90.29	97.37	105.59
	ly	44.46			
	1916251				
	lx	136.16	152.4	162.96	175.02
	ly	49.69			
	1916256				
	lx	69.31	78.27	84.18	91.01
	ly	8.04			
	1916258				
	lx	34.01	37.99	40.57	43.51
	ly	6.97			
	1916259				
	lx	62.48	69.29	73.65	78.57
	ly	8.09			
	1916260				
	lx	107.66	118.28	124.97	132.42
	ly	8.53			

WICSTYLE 65 evo / 65

Stützenprofile
Mullion profiles for windows

Statische Werte
Statical values

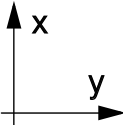
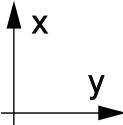
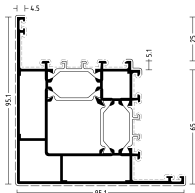
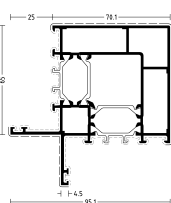
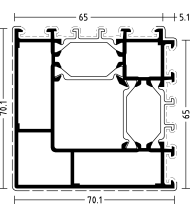
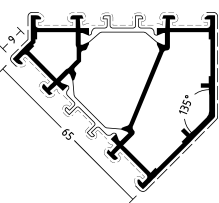
		Artikel-Nr. / Article-no.				
		lx	eff (cm ⁴) nach IfBt-Richtlinien eff (cm ⁴) acc. to IfBt guidelines			
		ly	add (cm ⁴) add (cm ⁴)			
		Stützweite L ab (cm) Bearing span L from (cm)				
			200	250	300	400
		1916270				
		lx	48.59	48.59	48.59	54.65
		ly	48.59			
		1916271				
		lx	30.87	30.87	30.87	30.87
		ly	45.99			
		1916272				
		lx	34.57	36.61	37.82	39.1
		ly	32.71			
		1916273				
		lx	16.83	18.48	19.51	20.66
		ly	10.74			

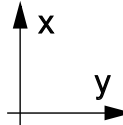
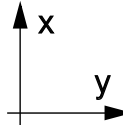
		Artikel-Nr. / Article-no.				
		lx	eff (cm ⁴) nach IfBt-Richtlinien eff (cm ⁴) acc. to IfBt guidelines			
		ly	add (cm ⁴) add (cm ⁴)			
		Stützweite L ab (cm) Bearing span L from (cm)				
			200	250	300	400
		lx				
		ly				

WICSTYLE 65 evo / 65

Schwellenprofile
Threshold profiles

Statische Werte
Statical values

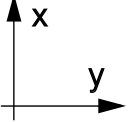
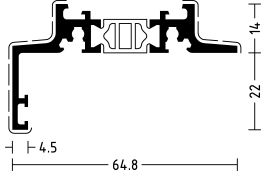
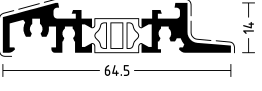
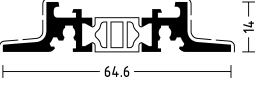
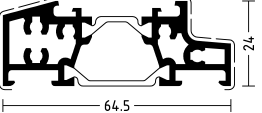
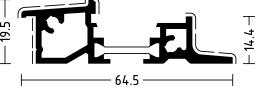
		Artikel-Nr. / Article-no.				
		lx	eff (cm ⁴) nach IfBt-Richtlinien eff (cm ⁴) acc. to IfBt guidelines			
		ly	add (cm ⁴) add (cm ⁴)			
		Stützweite L ab (cm) Bearing span L from (cm)				
			200	250	300	400
		1020457				
		lx	0	0	0	0
		ly	1.63			
		1926524				
		lx	7.02	7.92	8.51	9.2
		ly	0.37			
		1926525				
		lx	5.79	6.48	6.94	7.45
		ly	0.37			
		1926526				
		lx	13.56	15.03	15.97	17.03
		ly	1.78			
		1926547				
		lx	8.8	9.32	9.63	9.95
		ly	0.81			

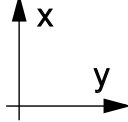
		Artikel-Nr. / Article-no.				
		lx	eff (cm ⁴) nach IfBt-Richtlinien eff (cm ⁴) acc. to IfBt guidelines			
		ly	add (cm ⁴) add (cm ⁴)			
		Stützweite L ab (cm) Bearing span L from (cm)				
			200	250	300	400

WICSTYLE 65 evo / 65

Aufsatzprofile
Supplementary profiles

Statische Werte
Statical values

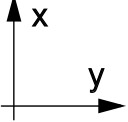
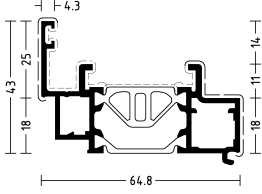
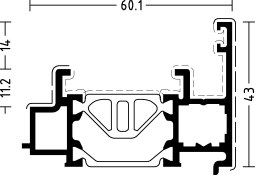
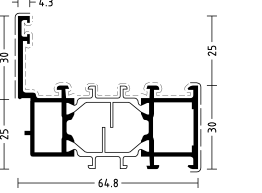
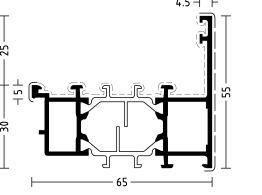
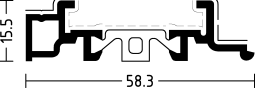
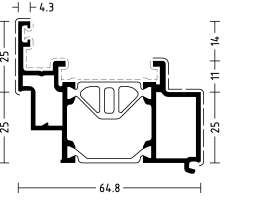
	Artikel-Nr. / Article-no.				
	lx	eff (cm ⁴) nach IfBt-Richtlinien eff (cm ⁴) acc. to IfBt guidelines			
	ly	add (cm ⁴) add (cm ⁴)			
	Stützweite L ab (cm) Bearing span L from (cm)				
	200	250	300	400	
	1020452				
lx	14.85	16.38	17.35	18.43	
ly	3.72				
	1020453				
lx	13.57	14.86	15.68	16.58	
ly	4				
	1916301				
lx	16.35	17.99	19.04	20.2	
ly	5.46				
	1916303				
lx	15.5	17.01	17.95	19.01	
ly	6.26				
	1926520				
lx	6.08	6.42	6.63	6.84	
ly	.33				
	1926521				
lx	15.7	17.37	18.43	19.63	
ly	5.74				

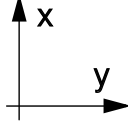
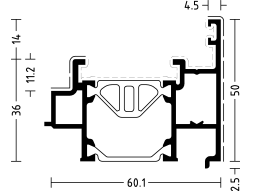
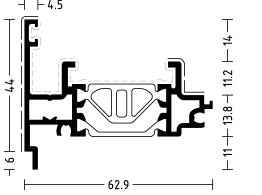
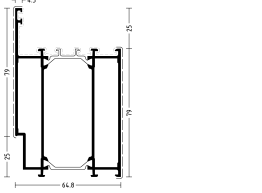
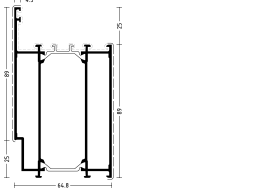
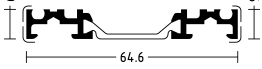
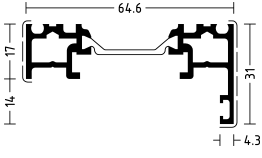
	Artikel-Nr. / Article-no.				
	lx	eff (cm ⁴) nach IfBt-Richtlinien eff (cm ⁴) acc. to IfBt guidelines			
	ly	add (cm ⁴) add (cm ⁴)			
	Stützweite L ab (cm) Bearing span L from (cm)				
	200	250	300	400	
	1926522				
lx	13.97	15.38	16.28	17.27	
ly	5.95				
	1926523				
lx	13.62	14.92	15.73	16.64	
ly	3.67				
	1926527				
lx	26.16	30.48	33.47	37.1	
ly	54.9				
	1926528				
lx	27.7	32.55	35.97	40.17	
ly	74.2				
	1926529				
lx	7.33	7.67	7.88	8.09	
ly	0.1				
	1926530				
lx	13.8	14.96	15.67	16.45	
ly	1.45				

WICSTYLE 65 evo / 65

Aufsatzprofile
Supplementary profiles

Statische Werte
Statical values

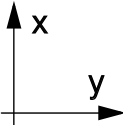
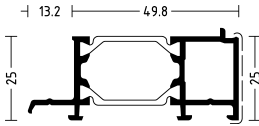
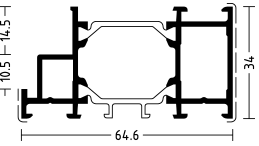
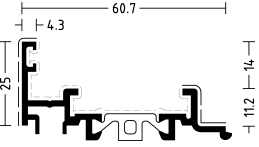
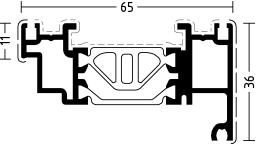
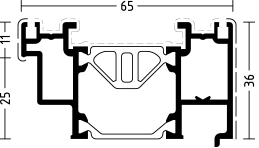
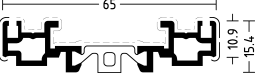
		Artikel-Nr. / Article-no.				
		lx	eff (cm ⁴) nach IfBt-Richtlinien eff (cm ⁴) acc. to IfBt guidelines			
		ly	add (cm ⁴) add (cm ⁴)			
		Stützweite L ab (cm) Bearing span L from (cm)				
		200 250 300 400				
		1926531				
		lx	8.52	9.09	9.43	9.8
		ly	1.61			
		1926532				
		lx	13.23	14.47	15.24	16.1
		ly	3.46			
		1926533				
		lx	8.64	9.17	9.49	9.83
		ly	0.92			
		1926537				
		lx	15.05	16.59	17.57	18.66
		ly	2.87			
		1926538				
		lx	15.28	16.88	17.91	19.05
		ly	4.61			
		1926539				
		lx	10.38	11.12	11.57	12.05
		ly	.42			

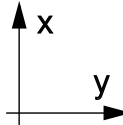
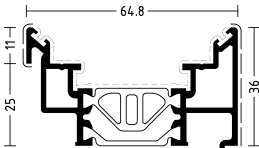
		Artikel-Nr. / Article-no.				
		lx	eff (cm ⁴) nach IfBt-Richtlinien eff (cm ⁴) acc. to IfBt guidelines			
		ly	add (cm ⁴) add (cm ⁴)			
		Stützweite L ab (cm) Bearing span L from (cm)				
		200 250 300 400				
		1926545				
		lx	15.48	17.04	18.02	19.11
		ly	3.51			

WICSTYLE 65 evo / 65

Bauanschlussprofile
Profiles for junction to structure

Statische Werte
Statical values

Artikel-Nr. / Article-no.	
lx	eff (cm ⁴) nach IfBt-Richtlinien eff (cm ⁴) acc. to IfBt guidelines
ly	add (cm ⁴) add (cm ⁴)
Stützweite L ab (cm) Bearing span L from (cm)	
200 250 300 400	

	1916307			
	lx	43.82	50.21	54.52
ly	19.65			

Artikel-Nr. / Article-no.	
lx	eff (cm ⁴) nach IfBt-Richtlinien eff (cm ⁴) acc. to IfBt guidelines
ly	add (cm ⁴) add (cm ⁴)
Stützweite L ab (cm) Bearing span L from (cm)	
200 250 300 400	

WICSTYLE 75 evo

Eckwinkelzuschnitt / Auswahltabellen

Cutting corner angle / Selection tables

Profile
Profiles

Profil-Nr. Profil-No.			
1010425	3000074	13.2 mm	5930003
	3000074	13.2 mm	5930003
1017077	3900049	11.7 mm	5930010
	3900049	13.2 mm	5930010
1020501	3900052	9.5 mm	5930031
	4950352	-	5930031
1020502	3900051	33.2 mm	5930003
	3900051	13.2 mm	5930003
1020503	3900051	33.2 mm	5930003
	3900051	13.2 mm	5930003
1020504	3900051	33.2 mm	5930003
	3900051	13.2 mm	5930003
1020515	3900052	9.5 mm	5930031
	4050587	-	5930031
1320033	3900052	9.5 mm	5930030
	4950059	-	5930030
1917001	3000074	13.2 mm	5930003
	3000074	13.2 mm	5930003
1917002	3900048	13.2 mm	5930003
	3900048	13.2 mm	5930003
1917003	3900049	13.2 mm	5930003
	3900049	13.2 mm	5930003
1917004	3900050	13.2 mm	5930003
	3900050	13.2 mm	5930003
1917005	3900051	13.2 mm	5930003
	3900051	13.2 mm	5930003
1917009	3900049	23.2 mm	5930005
	3900049	13.2 mm	5930005
1917055	3000074	13.2 mm	5930003
	3000074	13.2 mm	5930003
1917056	3900048	13.2 mm	5930003
	3900048	13.2 mm	5930003
1917057	3900049	13.2 mm	5930003
	3900049	13.2 mm	5930003





Profil-Nr. Profil-No.			
1917058	3900050	13.2 mm	5930003
	3900050	13.2 mm	5930003
1917059	3900051	13.2 mm	5930003
	3900051	13.2 mm	5930003
1917060	3900053	13.2 mm	5930003
	3900053	13.2 mm	5930003
1917062	3900030	13.2 mm	5930003
	3900030	13.2 mm	5930003
1917064	3900049	13.2 mm	5930003
	3900049	13.2 mm	5930003
1917067	3900052	13.2 mm	5930003
	3900052	13.2 mm	5930003
1917068	3000074	13.2 mm	5930003
	3000074	13.2 mm	5930003
1917069	3900049	13.2 mm	5930003
	3900049	13.2 mm	5930003
1917073	3900049	13.2 mm	5930003
	3900049	13.2 mm	5930003
1917076	3000074	7.7 mm	5930010
	3000074	13.2 mm	5930010
1917077	3900049	11.7 mm	5930010
	3900049	13.2 mm	5930010
1917201	3000074	13.2 mm	5930003
	3000074	13.2 mm	5930003
1917202	3900048	13.2 mm	5930003
	3900048	13.2 mm	5930003
1917203	3900049	13.2 mm	5930003
	3900049	13.2 mm	5930003
1917204	3900050	13.2 mm	5930003
	3900050	13.2 mm	5930003
1917205	3900051	13.2 mm	5930003
	3900051	13.2 mm	5930003
1917206	3900052	13.2 mm	5930003
	3900052	13.2 mm	5930003









WICSTYLE 75 evo







Eckwinkelzuschnitt / Auswahltabellen







Cutting corner angle / Selection tables

Profile
Profiles

			
Profil-Nr. Profil-No.			
 1917207	3900053	13.2 mm	5930003
	3900053	13.2 mm	5930003
1917241	3900049	13.2 mm	5930003
	3900049	13.2 mm	5930003
1917244	3900049	13.2 mm	5930003
	3900049	13.2 mm	5930003
1917246	3900049	13.2 mm	5930003
	3900049	13.2 mm	5930003
1917247	3900049	13.2 mm	5930003
	3900049	13.2 mm	5930003
1917248	3900049	13.2 mm	5930003
	3900049	13.2 mm	5930003
1917249	3900051	13.2 mm	5930003
	3900051	13.2 mm	5930003
1917250	3900051	13.2 mm	5930003
	3900051	13.2 mm	5930003
1917251	3900051	13.2 mm	5930003
	3900051	13.2 mm	5930003
1917256	3900030	13.2 mm	5930003
	3900030	13.2 mm	5930003
1917258	3900030	13.2 mm	5930003
	3900030	13.2 mm	5930003
1917259	3900030	13.2 mm	5930003
	3900030	13.2 mm	5930003
1917260	3900030	13.2 mm	5930003
	3900030	13.2 mm	5930003
1917301	3900049	9.2 mm	5930003
	3900049	13.2 mm	5930003
1917303	3900049	13.2 mm	5930003
	3900049	9.2 mm	5930003
1920513	3900052	9.5 mm	5930030
	3900052	9.5 mm	5930030
1920517	3900052	9.5 mm	5930030
	4950059	-	5930030

			
Profil-Nr. Profil-No.			
 1927500	3900049	13.2 mm	5930003
	3900049	13.2 mm	5930003
1927501	3900043	13.2 mm	5930003
	3900043	13.2 mm	5930003
1927502	3900051	13.2 mm	5930003
	3900051	13.2 mm	5930003
1927506	3000074	7.7 mm	5930010
	3000074	13.2 mm	5930010
1927507	3000074	7.7 mm	5930010
	3000074	13.2 mm	5930010
1927510	-	-	-
	-	-	-
1927511	-	-	-
	-	-	-
1927512	3900044	13.2 mm	5930003
	3900044	13.2 mm	5930003
1927513	-	-	-
	-	-	-
1927514	-	-	-
	-	-	-
1927515	3900044	13.2 mm	5930003
	3900044	13.2 mm	5930003

			
Profil-Nr. Profil-No.			
<input checked="" type="checkbox"/>			
<input type="checkbox"/>			

			
Profil-Nr. Profil-No.			
<input checked="" type="checkbox"/>			
<input type="checkbox"/>			

Hinweis:

Die ausgewiesenen Gusseckwinkel in den Datenspalten der Programm-Seiten können wie nachfolgend aufgeführt durch Al-Strangpresseckwinkel im „Selbstzuschnitt“ und Prestaverbindung (Stanzverbindung) ersetzt werden. Die konventionelle Verklebung ist mit 2-komponenten Klebstoff 5070000 oder 2-komponenten Epoxid-Klebstoff 5070002 auszuführen.

Siehe Allgemeine Verarbeitungshinweise.

Zuschnittstoleranzen nach DIN ISO 2768,

T1 fein ($\leq 30.0 \text{ mm} \pm 0.1 \text{ mm}$, $> 30.0 \text{ mm} \pm 0.15 \text{ mm}$).

Profil-Nr. 1927510, 1927511, 1927513, 1927514 sind für Eckwinkelzuschnitt nicht zugelassen.

Note:

The specified cast alum. corner angles in head columns of Profile Programme pages can be replaced by extruded alum. corner angles in „self-cut“ and crimping connection (punched connection) as listed. The conventional gluing should be carried out with 2-component glue 5070000 or 2-component Epoxide glue 5070002.

See general processing hints.

Cutting tolerance according to DIN ISO 2768,

T1 fine ($\leq 30.0 \text{ mm} \pm 0.1 \text{ mm}$, $> 30.0 \text{ mm} \pm 0.15 \text{ mm}$).





Profile-No. 1927510, 1927511, 1927513, 1927514 are not approved for cutting corner angle.

WICSTYLE 75 evo

Zuordnung Gelenkeckwinkel, vertikal
Assignment hinged corner angle, vertical

Profile
Profiles

			
Profil-Nr. Profil-No.			
<input checked="" type="checkbox"/> 1010425	4950060	2x4070002	5910010
<input type="checkbox"/>	4950060	2x4070002	5910010
1917001	4950060	2x4070002	5910010
	4950060	2x4070002	5910010
1917002	4950061	2x4070002	5910010
	4950061	2x4070002	5910010
1917003	4950062	2x4070002	5910010
	4950062	2x4070002	5910010
1917004	4950063	2x4070002	5910010
	4950063	2x4070002	5910010
1917055	4950060	2x4070002	5910010
	4950060	2x4070002	5910010
1917056	4950061	2x4070002	5910010
	4950061	2x4070002	5910010
1917057	4950062	2x4070002	5910010
	4950062	2x4070002	5910010
1917058	4950063	2x4070002	5910010
	4950063	2x4070002	5910010
1917064	4950062	2x4070002	5910010
	4950062	2x4070002	5910010
1917068	4950060	2x4070002	5910010
	4950060	2x4070002	5910010
1917069	4950062	2x4070002	5910010
	4950062	2x4070002	5910010
1917073	4950062	2x4070002	5910010
	4950062	2x4070002	5910010
1917201	4950060	2x4070002	5910010
	4950060	2x4070002	5910010
1917202	4950061	2x4070002	5910010
	4950061	2x4070002	5910010
1917203	4950062	2x4070002	5910010
	4950062	2x4070002	5910010
1917204	4950063	2x4070002	5910010
	4950063	2x4070002	5910010







			
Profil-Nr. Profil-No.			
<input checked="" type="checkbox"/> 1917241	4950062	2x4070002	5910010
<input type="checkbox"/>	4950062	2x4070002	5910010
1917244	4950062	2x4070002	5910010
	4950062	2x4070002	5910010
1917246	4950062	2x4070002	5910010
	4950062	2x4070002	5910010
1917247	4950062	2x4070002	5910010
	4950062	2x4070002	5910010
1917248	4950062	2x4070002	5910010
	4950062	2x4070002	5910010

WICSTYLE 75 evo

Zuordnung Gelenkeckwinkel, horizontal
Assignment hinged corner angle, horizontal

Profile
Profiles



				
Profil-Nr. Profil-No.				
<input checked="" type="checkbox"/>	1010425	4950076	2x4070002	5910012
<input type="checkbox"/>		4950076	2x4070002	5910012
	1917001	4950076	2x4070002	5910012
		4950076	2x4070002	5910012
	1917002	4950077	2x4070002	5910012
		4950077	2x4070002	5910012
	1917003	4950078	2x4070002	5910012
		4950078	2x4070002	5910012
	1917004	4950079	2x4070002	5910012
		4950079	2x4070002	5910012
	1917055	4950076	2x4070002	5910012
		4950076	2x4070002	5910012
	1917056	4950077	2x4070002	5910012
		4950077	2x4070002	5910012
	1917057	4950078	2x4070002	5910012
		4950078	2x4070002	5910012
	1917058	4950079	2x4070002	5910012
		4950079	2x4070002	5910012
	1917064	4950078	2x4070002	5910012
		4950078	2x4070002	5910012
	1917068	4950076	2x4070002	5910012
		4950076	2x4070002	5910012
	1917069	4950078	2x4070002	5910012
		4950078	2x4070002	5910012
	1917073	4950078	2x4070002	5910012
		4950078	2x4070002	5910012
	1917201	4950076	2x4070002	5910012
		4950076	2x4070002	5910012
	1917202	4950077	2x4070002	5910012
		4950077	2x4070002	5910012
	1917203	4950078	2x4070002	5910012
		4950078	2x4070002	5910012
	1917204	4950079	2x4070002	5910012
		4950079	2x4070002	5910012







				
Profil-Nr. Profil-No.				
<input checked="" type="checkbox"/>	1917241	4950078	2x4070002	5910012
<input type="checkbox"/>		4950078	2x4070002	5910012
	1917244	4950078	2x4070002	5910012
		4950078	2x4070002	5910012
	1917246	4950078	2x4070002	5910012
		4950078	2x4070002	5910012
	1917247	4950078	2x4070002	5910012
		4950078	2x4070002	5910012
	1917248	4950078	2x4070002	5910012
		4950078	2x4070002	5910012

WICSTYLE 75 evo

Zuordnung Gelenkverbinder
Assignment hinged connector

Profile
Profiles

				
Profil-Nr. Profil-No.				
<input checked="" type="checkbox"/>	1010425	4960045	1x4070002	5910011
<input type="checkbox"/>		4960040	1x4070002	5910011
	1917001	4960045	1x4070002	5910011
		4960040	1x4070002	5910011
	1917002	4960046	1x4070002	5910011
		4960041	1x4070002	5910011
	1917003	4960047	1x4070002	5910011
		4960042	1x4070002	5910011
	1917004	4960048	1x4070002	5910011
		4960043	1x4070002	5910011
	1917055	4960045	1x4070002	5910011
		4960040	1x4070002	5910011
	1917056	4960046	1x4070002	5910011
		4960041	1x4070002	5910011
	1917057	4960047	1x4070002	5910011
		4960042	1x4070002	5910011
	1917058	4960048	1x4070002	5910011
		4960043	1x4070002	5910011
	1917064	4960047	1x4070002	5910011
		4960042	1x4070002	5910011
	1917068	4960045	1x4070002	5910011
		4960040	1x4070002	5910011
	1917069	4960047	1x4070002	5910011
		4960042	1x4070002	5910011
	1917073	4960047	1x4070002	5910011
		4960042	1x4070002	5910011
	1917201	4960045	1x4070002	5910011
		4960040	1x4070002	5910011
	1917202	4960046	1x4070002	5910011
		4960041	1x4070002	5910011
	1917203	4960047	1x4070002	5910011
		4960042	1x4070002	5910011
	1917204	4960048	1x4070002	5910011
		4960043	1x4070002	5910011









				
Profil-Nr. Profil-No.				
<input checked="" type="checkbox"/>	1917241	4960047	1x4070002	5910011
<input type="checkbox"/>		4960042	1x4070002	5910011
	1917244	4960047	1x4070002	5910011
		4960042	1x4070002	5910011
	1917246	4960047	1x4070002	5910011
		4960042	1x4070002	5910011
	1917247	4960047	1x4070002	5910011
		4960042	1x4070002	5910011
	1917248	4960047	1x4070002	5910011
		4960042	1x4070002	5910011



WICSTYLE 65 evo / 65

Profile
Profiles

Eckwinkelzuschnitt / Auswahltabellen

Cutting corner angle / Selection tables

			
Profil-Nr. Profil-No.			
 1010187	3000074	13.2 mm	5930001
	3000074	13.2 mm	5930001
1320034	3900052	9.5 mm	5930030
	4950059	-	5930030
1916001	3000074	13.2 mm	5930001
	3000074	13.2 mm	5930001
1916002	3900006	13.2 mm	5930001
	3900006	13.2 mm	5930001
1916003	3900007	13.2 mm	5930001
	3900007	13.2 mm	5930001
1916004	3900050	13.2 mm	5930001
	3900050	13.2 mm	5930001
1916005	3900011	13.2 mm	5930001
	3900011	13.2 mm	5930001
1916009	3900007	23.2 mm	5930003
	3900007	13.2 mm	5930003
1916055	3000074	13.2 mm	5930001
	3000074	13.2 mm	5930001
1916056	3900006	13.2 mm	5930001
	3900006	13.2 mm	5930001
1916057	3900007	13.2 mm	5930001
	3900007	13.2 mm	5930001
1916058	3900050	13.2 mm	5930001
	3900050	13.2 mm	5930001
1916059	3900011	13.2 mm	5930001
	3900011	13.2 mm	5930001
1916060	3900040	13.2 mm	5930001
	3900040	13.2 mm	5930001
1916062	3900030	13.2 mm	5930001
	3900030	13.2 mm	5930001
1916064	3900007	13.2 mm	5930001
	3900007	13.2 mm	5930001
1916067	3900012	13.2 mm	5930001
	3900012	13.2 mm	5930001









			
Profil-Nr. Profil-No.			
 1916068	3000074	13.2 mm	5930001
	3000074	13.2 mm	5930001
1916069	3900007	13.2 mm	5930001
	3900007	13.2 mm	5930001
1916073	3900007	13.2 mm	5930001
	3900007	13.2 mm	5930001
1916076	3000074	7.7 mm	5930008
	3000074	13.2 mm	5930008
1916077	3900007	11.7 mm	5930008
	3900007	13.2 mm	5930008
1916201	3000074	13.2 mm	5930001
	3000074	13.2 mm	5930001
1916202	3900006	13.2 mm	5930001
	3900006	13.2 mm	5930001
1916203	3900007	13.2 mm	5930001
	3900007	13.2 mm	5930001
1916204	3900050	13.2 mm	5930001
	3900050	13.2 mm	5930001
1916205	3900011	13.2 mm	5930001
	3900011	13.2 mm	5930001
1916206	3900012	13.2 mm	5930001
	3900012	13.2 mm	5930001
1916207	3900040	13.2 mm	5930001
	3900040	13.2 mm	5930001
1916241	3900007	13.2 mm	5930001
	3900007	13.2 mm	5930001
1916244	3900007	13.2 mm	5930001
	3900007	13.2 mm	5930001
1916246	3900007	13.2 mm	5930001
	3900007	13.2 mm	5930001
1916247	3900007	13.2 mm	5930001
	3900007	13.2 mm	5930001
1916248	3900007	13.2 mm	5930001
	3900007	13.2 mm	5930001









WICSTYLE 65 evo / 65

Profile Profiles

Eckwinkelzuschnitt / Auswahltabellen

Cutting corner angle / Selection tables







			
Profil-Nr. Profil-No.			
 1916249	3900011	13.2 mm	5930001
	3900011	13.2 mm	5930001
1916250	3900011	13.2 mm	5930001
	3900011	13.2 mm	5930001
1916251	3900011	13.2 mm	5930001
	3900011	13.2 mm	5930001
1916256	3900030	13.2 mm	5930001
	3900030	13.2 mm	5930001
1916258	3900030	13.2 mm	5930001
	3900030	13.2 mm	5930001
1916259	3900030	13.2 mm	5930001
	3900030	13.2 mm	5930001
1916260	3900030	13.2 mm	5930001
	3900030	13.2 mm	5930001
1916301	3900007	9.2 mm	5930001
	3900007	13.2 mm	5930001
1916303	3900007	13.2 mm	5930001
	3900007	9.2 mm	5930001
1920512	3900012	9.5 mm	5930030
	3900012	9.5 mm	5930030
1920516	3900012	9.5 mm	5930030
	4950059	-	5930030
1926500	3900007	13.2 mm	5930001
	3900007	13.2 mm	5930001
1926501	3900043	13.2 mm	5930001
	3900043	13.2 mm	5930001
1926502	3900011	13.2 mm	5930001
	3900011	13.2 mm	5930001
1926503	3900011	13.2 mm	5930001
	3900011	13.2 mm	5930001
1926506	3000074	7.7 mm	5930008
	3000074	13.2 mm	5930008
1926507	3000074	7.7 mm	5930008
	3000074	13.2 mm	5930008







			
Profil-Nr. Profil-No.			
 1926510	-	-	-
	-	-	-
1926511	-	-	-
	-	-	-
1926512	3900044	13.2 mm	5930001
	3900044	13.2 mm	5930001
1926513	-	-	-
	-	-	-
1926514	-	-	-
	-	-	-
1926515	3900044	13.2 mm	5930001
	3900044	13.2 mm	5930001
1926535	-	-	-
	-	-	-
1926536	-	-	-
	-	-	-
1926541	3900007	13.2 mm	5930001
	3900007	13.2 mm	5930001
1926542	3900011	13.2 mm	5930001
	3900011	13.2 mm	5930001

WICSTYLE 65 evo / 65

Eckwinkelzuschnitt / Auswahltabellen

Cutting corner angle / Selection tables

			
Profil-Nr. Profil-No.			
<input checked="" type="checkbox"/>			
<input type="checkbox"/>			

			
Profil-Nr. Profil-No.			
<input checked="" type="checkbox"/>			
<input type="checkbox"/>			

Hinweis:

Die ausgewiesenen Gusseckwinkel in den Datenspalten der Programm-Seiten können wie nachfolgend aufgeführt durch Al-Strangpresseckwinkel im „Selbstzuschnitt“ und Prestaverbindung (Stanzverbindung) ersetzt werden. Die konventionelle Verklebung ist mit 2-komponenten Klebstoff 5070000 oder 2-komponenten Epoxid-Klebstoff 5070002 auszuführen.

Siehe Allgemeine Verarbeitungshinweise.

Zuschnittstoleranzen nach DIN ISO 2768,

T1 fein ($\leq 30.0 \text{ mm} \pm 0.1 \text{ mm}$, $> 30.0 \text{ mm} \pm 0.15 \text{ mm}$).

Profil-Nr. 1926510, 1926511, 1926513, 1926514, 1926535, 1926536 sind für Eckwinkelzuschnitt nicht zugelassen.

Note:

The specified cast alum. corner angles in head columns of Profile Programme pages can be replaced by extruded alum. corner angles in „self-cut“ and crimping connection (punched connection) as listed. The conventional gluing should be carried out with 2-component glue 5070000 or 2-component Epoxide glue 5070002.

See general processing hints.

Cutting tolerance according to DIN ISO 2768,

T1 fine ($\leq 30.0 \text{ mm} \pm 0.1 \text{ mm}$, $> 30.0 \text{ mm} \pm 0.15 \text{ mm}$).





Profile-No. 1926510, 1926511, 1926513, 1926514, 1926535, 1926536 are not approved for cutting corner angle.

WICSTYLE 65 evo / 65

Profile Profiles

Zuordnung Gelenkeckwinkel, vertikal
Assignment hinged corner angle, vertical

			
Profil-Nr. Profil-No.			
<input checked="" type="checkbox"/> 1010187	4950060	2x4070002	5910010
<input type="checkbox"/>	4950060	2x4070002	5910010
1916001	4950060	2x4070002	5910010
	4950060	2x4070002	5910010
1916002	4950061	2x4070002	5910010
	4950061	2x4070002	5910010
1916003	4950062	2x4070002	5910010
	4950062	2x4070002	5910010
1916004	4950063	2x4070002	5910010
	4950063	2x4070002	5910010
1916055	4950060	2x4070002	5910010
	4950060	2x4070002	5910010
1916056	4950061	2x4070002	5910010
	4950061	2x4070002	5910010
1916057	4950062	2x4070002	5910010
	4950062	2x4070002	5910010
1916058	4950063	2x4070002	5910010
	4950063	2x4070002	5910010
1916064	4950062	2x4070002	5910010
	4950062	2x4070002	5910010
1916068	4950060	2x4070002	5910010
	4950060	2x4070002	5910010
1916069	4950062	2x4070002	5910010
	4950062	2x4070002	5910010
1916073	4950062	2x4070002	5910010
	4950062	2x4070002	5910010
1916201	4950060	2x4070002	5910010
	4950060	2x4070002	5910010
1916202	4950061	2x4070002	5910010
	4950061	2x4070002	5910010
1916203	4950062	2x4070002	5910010
	4950062	2x4070002	5910010







			
Profil-Nr. Profil-No.			
<input checked="" type="checkbox"/> 1916204	4950063	2x4070002	5910010
<input type="checkbox"/>	4950063	2x4070002	5910010
1916241	4950062	2x4070002	5910010
	4950062	2x4070002	5910010
1916244	4950062	2x4070002	5910010
	4950062	2x4070002	5910010
1916246	4950062	2x4070002	5910010
	4950062	2x4070002	5910010
1916247	4950062	2x4070002	5910010
	4950062	2x4070002	5910010
1916248	4950062	2x4070002	5910010
	4950062	2x4070002	5910010

WICSTYLE 65 evo / 65

Zuordnung Gelenkeckwinkel, horizontal
Assignment hinged corner angle, horizontal

Profile
Profiles



			
Profil-Nr. Profil-No.			
<input checked="" type="checkbox"/> 1010187	4950076	2x4070002	5910012
<input type="checkbox"/>	4950076	2x4070002	5910012
1916001	4950076	2x4070002	5910012
	4950076	2x4070002	5910012
1916002	4950077	2x4070002	5910012
	4950077	2x4070002	5910012
1916003	4950078	2x4070002	5910012
	4950078	2x4070002	5910012
1916004	4950079	2x4070002	5910012
	4950079	2x4070002	5910012
1916055	4950076	2x4070002	5910012
	4950076	2x4070002	5910012
1916056	4950077	2x4070002	5910012
	4950077	2x4070002	5910012
1916057	4950078	2x4070002	5910012
	4950078	2x4070002	5910012
1916058	4950079	2x4070002	5910012
	4950079	2x4070002	5910012
1916064	4950078	2x4070002	5910012
	4950078	2x4070002	5910012
1916068	4950076	2x4070002	5910012
	4950076	2x4070002	5910012
1916069	4950078	2x4070002	5910012
	4950078	2x4070002	5910012
1916073	4950078	2x4070002	5910012
	4950078	2x4070002	5910012
1916201	4950076	2x4070002	5910012
	4950076	2x4070002	5910012
1916202	4950077	2x4070002	5910012
	4950077	2x4070002	5910012
1916203	4950078	2x4070002	5910012
	4950078	2x4070002	5910012







			
Profil-Nr. Profil-No.			
<input checked="" type="checkbox"/> 1916204	4950079	2x4070002	5910012
<input type="checkbox"/>	4950079	2x4070002	5910012
1916241	4950078	2x4070002	5910012
	4950078	2x4070002	5910012
1916244	4950078	2x4070002	5910012
	4950078	2x4070002	5910012
1916246	4950078	2x4070002	5910012
	4950078	2x4070002	5910012
1916247	4950078	2x4070002	5910012
	4950078	2x4070002	5910012
1916248	4950078	2x4070002	5910012
	4950078	2x4070002	5910012

WICSTYLE 65 evo / 65

Zuordnung Gelenkverbinder
Assignment hinged connector

Profile
Profiles

Profil-Nr. Profil-No.				
				
<input checked="" type="checkbox"/> 1010187	4960045	1x4070002	5910011	
<input type="checkbox"/> 1916001	4960040	1x4070002	5910011	
	4960045	1x4070002	5910011	
	4960040	1x4070002	5910011	
1916002	4960046	1x4070002	5910011	
	4960041	1x4070002	5910011	
1916003	4960047	1x4070002	5910011	
	4960042	1x4070002	5910011	
1916004	4960048	1x4070002	5910011	
	4960043	1x4070002	5910011	
1916055	4960045	1x4070002	5910011	
	4960040	1x4070002	5910011	
1916056	4960046	1x4070002	5910011	
	4960041	1x4070002	5910011	
1916057	4960047	1x4070002	5910011	
	4960042	1x4070002	5910011	
1916058	4960048	1x4070002	5910011	
	4960043	1x4070002	5910011	
1916064	4960047	1x4070002	5910011	
	4960042	1x4070002	5910011	
1916068	4960045	1x4070002	5910011	
	4960040	1x4070002	5910011	
1916069	4960047	1x4070002	5910011	
	4960042	1x4070002	5910011	
1916073	4960047	1x4070002	5910011	
	4960042	1x4070002	5910011	
1916201	4960045	1x4070002	5910011	
	4960040	1x4070002	5910011	
1916202	4960046	1x4070002	5910011	
	4960041	1x4070002	5910011	
1916203	4960047	1x4070002	5910011	
	4960042	1x4070002	5910011	

Profil-Nr. Profil-No.				
				
<input checked="" type="checkbox"/> 1916204	4960048	1x4070002	5910011	
<input checked="" type="checkbox"/>	4960043	1x4070002	5910011	
1916241	4960047	1x4070002	5910011	
	4960042	1x4070002	5910011	
1916244	4960047	1x4070002	5910011	
	4960042	1x4070002	5910011	
1916246	4960047	1x4070002	5910011	
	4960042	1x4070002	5910011	
1916247	4960047	1x4070002	5910011	
	4960042	1x4070002	5910011	
1916248	4960047	1x4070002	5910011	
	4960042	1x4070002	5910011	

WICSTYLE 75

Sprossenstoßverbindung
Glazing bar butt-joint connection

Sprossenprofile
Glazing bar profiles



Profil Profile	Bohrschablone Drill template
-------------------	---------------------------------

1917336	5910020
---------	---------

1917336	5910009
---------	---------

Profil Profile	Bohrschablone Drill template
-------------------	---------------------------------

1917336	5910020
---------	---------

1927510	5910009
1927511	
1927512	
1927513	
1927514	
1927515	

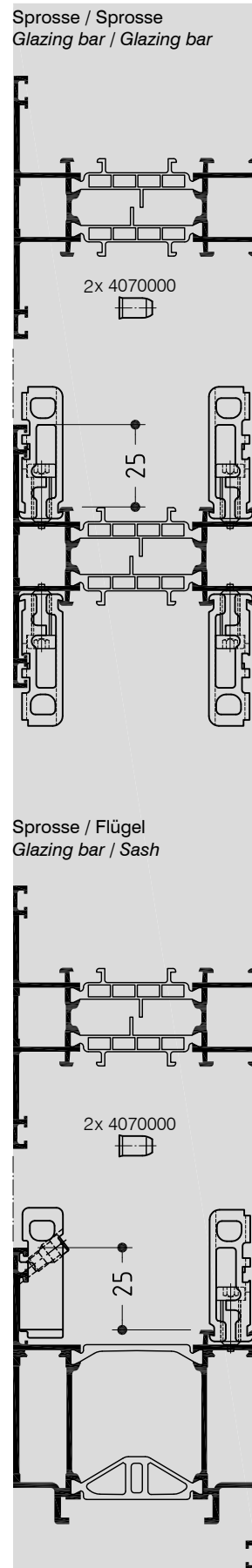

Profil Profile	Bohrschablone Drill template
-------------------	---------------------------------

1917201	5910006
1917202	
1917203	
1917204	
1917205	
1917206	
1917207	
1917209	
1917211	
1917213	
1917215	
1917220	
1917224	

1917201	--
1917202	
1917203	
1917204	
1917205	
1917206	
1917207	
1917209	
1917211	
1917213	
1917215	
1917220	
1917224	

Profil Profile	Bohrschablone Drill template
-------------------	---------------------------------

1917201	5910006
1917202	
1917203	
1917204	
1917205	
1917206	
1917207	
1917209	
1917211	
1917213	
1917215	
1917220	
1917224	

1927510	--
1927511	
1927512	
1927513	
1927514	
1927515	

WICSTYLE 75

Sprossenstoßverbindung Glazing bar butt-joint connection

Sprossenprofile Glazing bar profiles

Sprosse / Sprosse
Glazing bar / Glazing bar

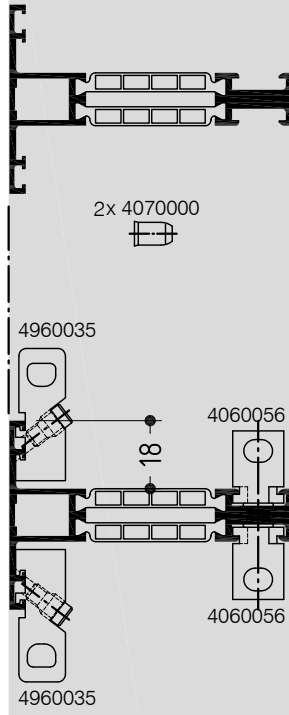

Profil
Profile

Bohrschablone
Drill template

1917336 5910020

1917336 5910009

Sprosse / Sprosse
Glazing bar / Glazing bar

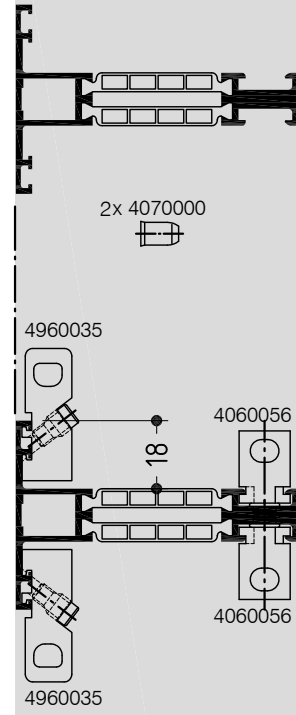

Profil
Profile

Bohrschablone
Drill template

1917336 5910020

1917336 5910009

Sprosse / Blendrahmen
Glazing bar / Frame

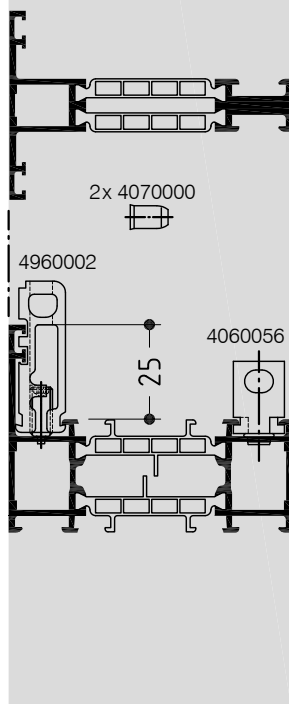

Profil
Profile

Bohrschablone
Drill template

1917336 5910020

1020508
1917001
1917002
1917003
1917004
1917005
1917062
1917064
1917067
1917068
5910009
1917069
1917073
1917076
1917077
1927516
1927517
1927518

Sprosse / Kämpfer
Glazing bar / Transom

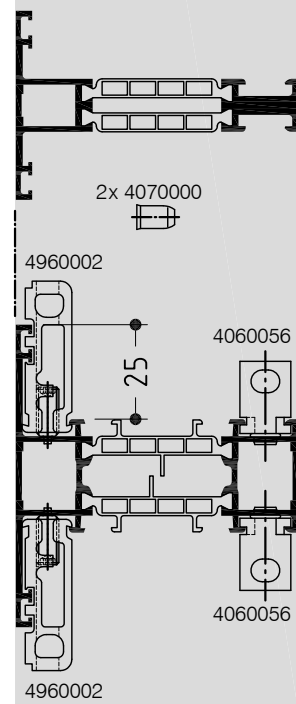

Profil
Profile

Bohrschablone
Drill template

1917336 5910020

1917201
1917202
1917203
1917204
1917205
1917206
1917207
5910009
1917209
1917211
1917213
1917215
1917220
1917224

WICSTYLE 75

Sprossenstoßverbindung
Glazing bar butt-joint connection

Sprossenprofile
Glazing bar profiles



Profil Profile	Bohrschablone Drill template
-------------------	---------------------------------

1917338 5910008
5910019

1917338 5910009

Profil Profile	Bohrschablone Drill template
-------------------	---------------------------------

1917338 5910008
5910019

1927510
1927511
1927512
1927513
1927514
1927515

5910009

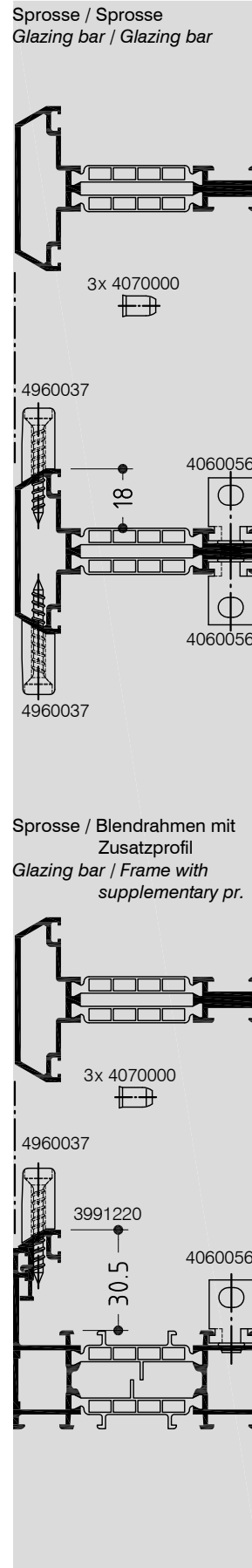

Profil Profile	Bohrschablone Drill template
-------------------	---------------------------------

1917338 5910008
5910019

1917338 5910009

Profil Profile	Bohrschablone Drill template
-------------------	---------------------------------

1917338 5910008
5910019

1020508
1917001
1917002
1917003
1917004
1917005
1917062
1917064
1917067
1917068
1917069
1917073
1917076
1917077
1927516
1927517
1927518

5910009

WICSTYLE 65

Sprossenstoßverbindung Glazing bar butt-joint connection

Sprossenprofile Glazing bar profiles

Sprosse / Sprosse
Glazing bar / Glazing bar

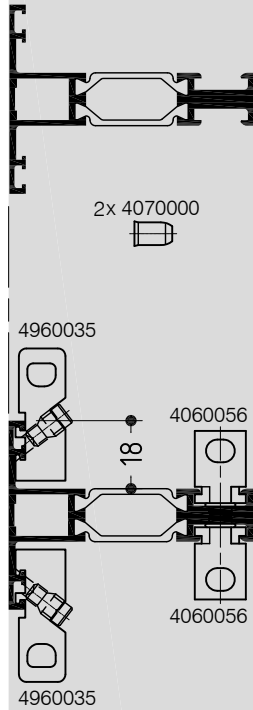

Profil
Profile

Bohrschablone
Drill template

1916336 5910019

1916336 5910009

Sprosse / Sprosse
Glazing bar / Glazing bar

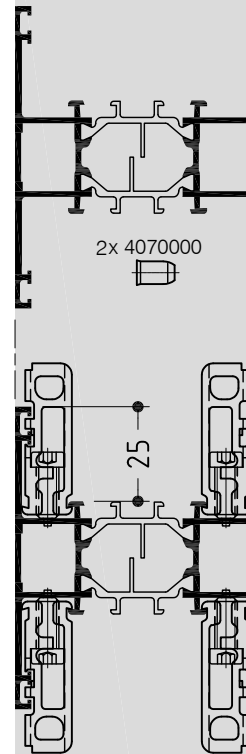

Profil
Profile

Bohrschablone
Drill template

1916201
1916202
1916203
1916204
1916205
1916206
1916207 5910004
1916209
1916211
1916213
1916215
1916220
1916224

1916201
1916202
1916203
1916204
1916205
1916206 --
1916207 --
1916209
1916211
1916213
1916215
1916220
1916224

Sprosse / Flügel
Glazing bar / Sash

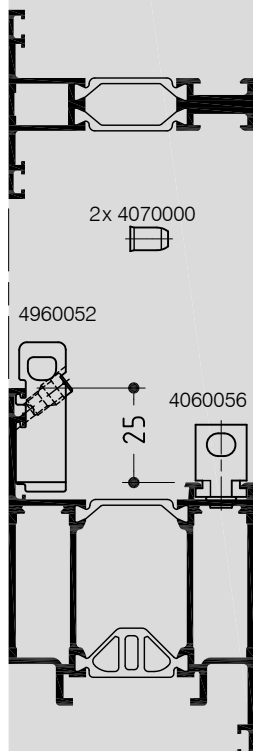

Profil
Profile

Bohrschablone
Drill template

1916336 5910019

1020509
1926510
1926511
1926512
1926513 5910009
1926514
1926515
1926534
1926535
1926536
1926540

Sprosse / Flügel
Glazing bar / Sash

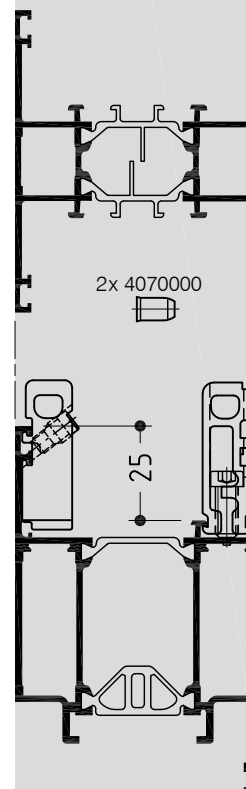

Profil
Profile

Bohrschablone
Drill template

1916201
1916202
1916203
1916204
1916205
1916206
1916207 5910004
1916209
1916211
1916213
1916215
1916220
1916224

1020509
1926510
1926511
1926512
1926513 --
1926514
1926515
1926534
1926535
1926536
1926540

WICSTYLE 65

Sprossenstoßverbindung Glazing bar butt-joint connection

Sprossenprofile Glazing bar profiles

Sprosse / Sprosse
Glazing bar / Glazing bar

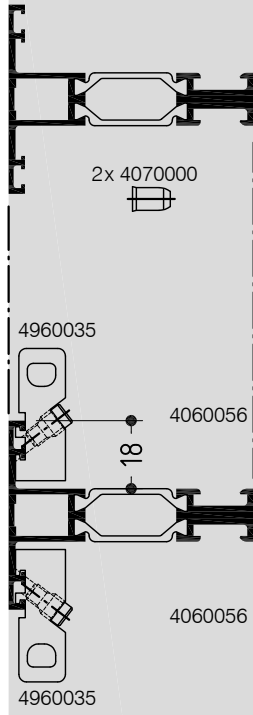

Profil
Profile

Bohrschablone
Drill template

1916336 5910019

1916336 5910009

Sprosse / Sprosse
Glazing bar / Glazing bar

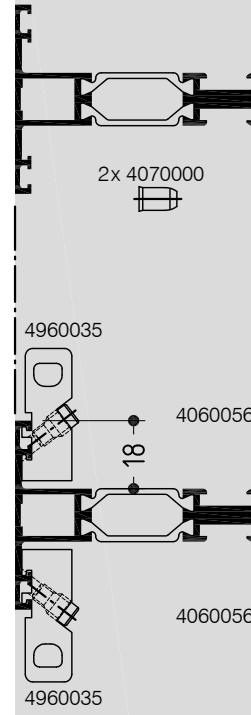

Profil
Profile

Bohrschablone
Drill template

1916336 5910019

1916336 5910009

Sprosse / Blendrahmen
Glazing bar / Frame

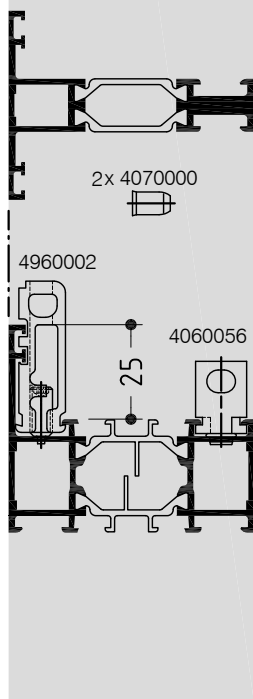

Profil
Profile

Bohrschablone
Drill template

1916336 5910019

1916001
1916002
1916003
1916004
1916005
1916019
1916062
1916064
1916067
1916068
1916069
1916073
1916076
1916077
1926516
1926517
1926518

5910009

Sprosse / Kämpfer
Glazing bar / Transom

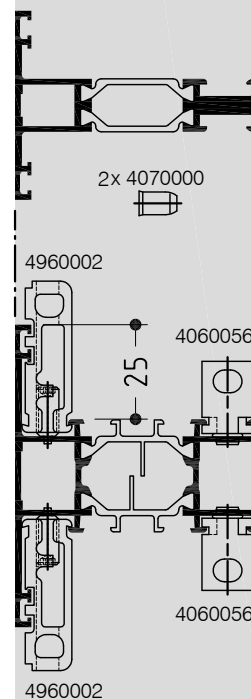

Profil
Profile

Bohrschablone
Drill template

1916336 5910019

1916201
1916202
1916203
1916204
1916205
1916206
1916207
1916209
1916211
1916213
1916215
1916220
1916224

5910009

WICSTYLE 65

Sprossenstoßverbindung Glazing bar butt-joint connection

Sprossenprofile Glazing bar profiles

Sprosse / Sprosse
Glazing bar / Glazing bar

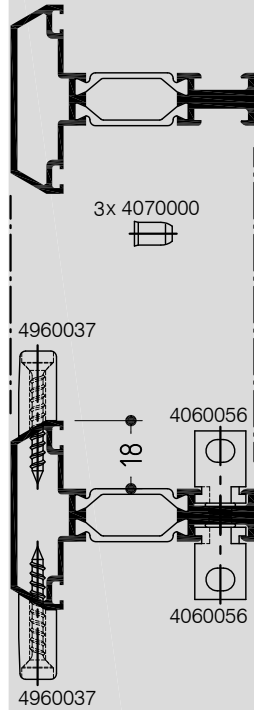

Profil Profile	Bohrschablone Drill template
-------------------	---------------------------------

1916338	5910008 5910019
---------	--------------------

1916338	5910009
---------	---------

Sprosse / Sprosse
Glazing bar / Glazing bar

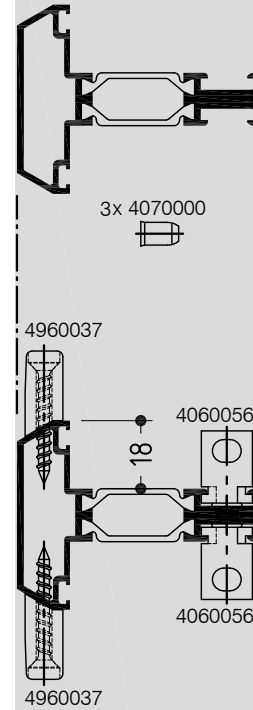

Profil Profile	Bohrschablone Drill template
-------------------	---------------------------------

1916338	5910008 5910019
---------	--------------------

1916338	5910009
---------	---------

Sprosse / Flügel
Glazing bar / Sash

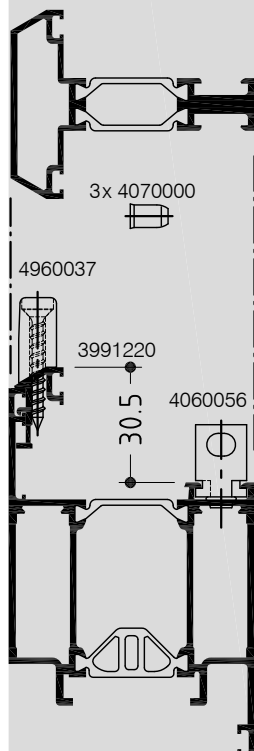

Profil Profile	Bohrschablone Drill template
-------------------	---------------------------------

1916338	5910008 5910019
---------	--------------------

1020509	
1926510	
1926511	
1926512	
1926513	5910009
1926514	
1926515	
1926534	
1926535	
1926536	
1926540	

Sprosse / Blendrahmen m.
Zusatzprofil
Glazing bar / Frame with
supplem. pr.

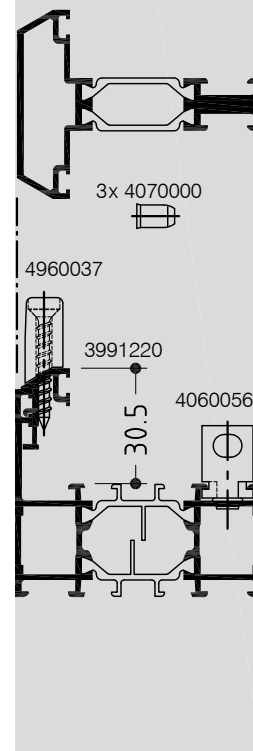

Profil Profile	Bohrschablone Drill template
-------------------	---------------------------------

1916338	5910008 5910019
---------	--------------------

1916001	
1916002	
1916003	
1916004	
1916005	
1916019	
1916062	
1916064	
1916067	5910009
1916068	
1916069	
1916073	
1916076	
1916077	
1926516	
1926517	
1926518	

Fenster / Türen, durchschusshemmend nach DIN EN 1522
Windows / doors, bullet resistant according to DIN EN 1522

Allgemeines:

Als Ergänzung zum Systemprogramm wurden die Serien WICLINE 65/75 in der durchschusshemmenden Widerstandsklasse bis FB 4 nach der aktuell gültigen europäischen Norm DIN EN 1522 geprüft.

Normen:

- DIN EN 1522
Fenster, Türen, Abschlüsse
Durchschusshemmung
Klassifizierung und Anforderungen
- DIN EN 1523
Fenster, Türen, Abschlüsse
Durchschusshemmung
Prüfverfahren
- DIN EN 1063
Sicherheitssonderverglasungen
Prüfverfahren und Klasseneinteilung für den Widerstand gegen Beschuss.

Hinweis:

Der Begriff "durchschusshemmende Verglasung" bezieht sich auf Erzeugnisse, die die eindeutigen Eigenschaften von Glas haben und die ein Verbund aus Glas und Kunststoff sind.

General:

In addition to the system program the series WICLINE 65/75 have been tested according to the current European standard DIN EN 1522 in the bullet resistance class up to FB 4.

Standards:

- DIN EN 1522
Windows, doors, closures
Bullet resistance
Classification and requirements
- DIN EN 1523
Windows, doors, closures
Bullet resistance
Testing procedures
- DIN EN 1063
Special safety glazings
Testing methods and classifications for the resistance against bullet attack.

Note:

The term "bullet resistant glazing" refers to products with the distinct properties of glass and which are a compound of glass and plastic.

Übersicht der einzelnen Widerstandsklassen und Zuordnung der Gläser:

Overview of the several classes of resistance and classification of the glasses:

Beschussklasse nach EN 1522 <i>Bullet resistant class according EN 1522</i>	Zertifizierte Gläser, geprüft nach DIN EN 1063 <i>Certified glazing, tested according DIN EN 1063</i>
FB 1	BR 1
FB 2	BR 2
FB 3	BR 3
FB 4	BR 4

Hinweise:

- Es dürfen nur die im Profilsystem geprüften und von den Glasherstellern zertifizierten Glástypen mit Nachweis eingesetzt werden.
- Unzulässig sind Veränderungen im Glasaufbau, Scheibenzwischenraum und Einbaudicke.
- Die mit Etikett gekennzeichnete Angriffseite der Verglasung muss mit der definierten Angriffseite des Profilsystems übereinstimmen.
- Gläser wahlweise mit zusätzlicher Kennzeichnung in Ausführung "NS" (kein Splitterabgang) oder in Ausführung "S" (mit Splitterabgang).

Notes:

- Only glass types which have been certified by the glass manufacturer with approval proof for the profile system may be used.
- Modifications to the glass design, glass interspace and infill Thickness are not allowed.
- The labelled assault side of the glazing must correspond with the assault side of the profile system.
- Glazings optionally with additional marking version "NS" (no splinters) or in version "S" (with splinters).

WICLINE 75 / WICSTYLE 75

Auswahl für durchschusshemmende Verglasung nach DIN EN 1063

Klasse BR 4-NS und BR 4-S im Mono- und Isolierglasaufbau

Selection for bullet resistant glazing according DIN EN 1063

Class BR 4-NS and BR 4-S in single and insulating glazing

Durchschusshemmende Verglasung, Klasse BR 4-NS nach EN 1063 / *Bullet resistant glazing, Class BR 4-NS according EN 1063*
Prüfzertifikat S 11 0032-03 FB 4-NS, Beschussamt Ulm / *Testcertificat S 11 0032-03 FB 4-NS, Department of ballistics Ulm*

Pos. Pos.	Klasse / Class (EN 1063)	Mono / Iso Single / Ins	Masse / Weight (kg/m ²)	Dicke / Thickness (mm)	Bezeichnung / Designation	Hersteller / Manufacturer
1	BR 4-NS	Iso	112	52	BR 4-NS-21	Flachglas Markenkreis GmbH
2	BR 4-NS	Iso	82	52	SGG STADIPT CP-HN 452-NS	Saint Gobain GmbH
3	BR 4-NS	Iso	110	56	SANCO SAFE BR 4-NS-ISO-0-56	Glas Trösch GmbH
4	BR 4-NS	Mono	115	48	Multistop -BR 4-NS-0-48	Glas Trösch GmbH
5	BR 4-NS	Iso	120	57	ipasafe BR 4-NS Isolierglas	Interpane Sicherheitsglas GmbH & Co
6	BR 4-NS	Mono	45	24	Novalay secure BR 4 NS / 1.3.1	Schott Technical Glassolution GmbH
7	BR 4-NS	Mono	96	44	Novalay secure BR 4-NS / 1.5.4	Schott Technical Glassolution GmbH
8	BR 4-NS	Iso	93	50	Novalay secure BR 4-NS / 1.6.6	Schott Technical Glassolution GmbH
9	BR 4-NS	Iso	94	60	Novalay secure BR 4-NS / 1.6.5	Schott Technical Glassolution GmbH
10	BR 4-NS	Iso 3-fach Iso triple	100	60	Novalay secure BR 4-NS / 1.6.5	Schott Technical Glassolution GmbH
11	BR 4-NS	Iso	100	57	Multipact 55 BR 4-NS Isolierglas	Glaswerke Arnold GmbH
12	BR 4-NS	Mono	53	25	SILATEC BR 4-NS 25/52	Silatec GmbH

Hinweis:

Pos.10 siehe Prüfzertifikat S 11 0090 01 / Z vom 24.08.2011, BA Ulm

Note:

Pos.10 see Testcertificat S 11 0090 01 / Z vom 24.08.2011, BA Ulm

Durchschusshemmende Verglasung, Klasse BR 4-S nach EN 1063 / *Bullet resistant glazing, Class BR 4-S according EN 1063*
Prüfzertifikat S 11 0032-04 FB 4-S, Beschussamt Ulm / *Testcertificat S 11 0032-04 FB 4-S, Department of ballistics Ulm*

Pos. Pos.	Klasse / Class (EN 1063)	Mono / Iso Single / Ins	Masse / Weight (kg/m ²)	Dicke / Thickness (mm)	Bezeichnung / Designation	Hersteller / Manufacturer
13	BR 4-S	Mono	63	36	P8B-17	Flachglas Markenkreis GmbH
14	BR 4-S	Iso	68	36	BR 4-S-21	Flachglas Markenkreis GmbH
15	BR 4-S	Iso	78	50	P8B-27	Flachglas Markenkreis GmbH
16	BR 4-S	Iso	90	50	SGG STADIPT CP-HN 432-S	Saint Gobain GmbH
17	BR 4-S	Iso	67	39	SANCO SAFE BR 4-S-ISO-0-39	Glas Trösch GmbH
18	BR 4-S	Mono	80	33	Multistop -BR 4-S-0-33	Glas Trösch GmbH
19	BR 4-S	Iso	72	41	ipasafe BR 4-S Isolierglas	Interpane Sicherheitsglas GmbH & Co
20	BR 4-S	Iso	68	43	Multipact 41 BR 4-S Isolierglas	Glaswerke Arnold GmbH

WICLINE 75 / WICSTYLE 75

Durchschusshemmende, nicht transparente Füllung nach DIN EN 1522

Klasse FB 4-NS

Bullet resistant, opaque infill according DIN EN 1522

Class BR 4-NS

Prüfzertifikat S 11 0032-03 FB 4-NS / *Testcertificat S 11 0032-03 FB 4-NS*
Prüfzertifikat S 11 0032-04 FB 4-S / *Testcertificat S 11 0032-04 FB 4-S*
Beschussamt Ulm / *Department of ballistics Ulm*

Pos. Pos.	Klasse / Class (EN 1522)	Mono / Iso Single / Ins	Masse / Weight (kg/m ²)	Dicke / Thickness (mm)	Bezeichnung / Designation	Hersteller / Manufacturer
21	FB 4-NS	Iso	65	40	Seropal-Paneel	Pohltec GmbH

Hinweis:

Pos.21, durchschusshemmendes, 2-lagiges Paneel mit speziellem Decklagenaufbau auf der Beschussseite aussen.

Note:

Pos.21, *bullet resistant double layer panel with special cover sheet compound on the assault side.*

WICLINE 65 / WICSTYLE 65

Auswahl für durchschusshemmende Verglasung nach DIN EN 1063

Klasse BR 4-NS und BR 4-S im Mono- und Isolierglasaufbau

Selection for bullet resistant glazing according DIN EN 1063

Class BR 4-NS and BR 4-S in single and insulating glazing

Durchschusshemmende Verglasung, Klasse BR 4-NS nach EN 1063 / *Bullet resistant glazing, Class BR 4-NS according EN 1063*
Prüfzertifikat S 11 0032-01 FB 4-NS, Beschussamt Ulm / *Test certificate S 11 0032-01 FB 4-NS, Department of ballistics Ulm*

Pos. Pos.	Klasse / Class (EN 1063)	Mono / Iso Single / Ins	Masse / Weight (kg/m ²)	Dicke / Thickness (mm)	Bezeichnung / Designation	Hersteller / Manufacturer
1	BR 4-NS	Mono	115	48	Multistop -BR 4-NS-0-48	Glas Trösch GmbH
2	BR 4-NS	Mono	45	24	Novalay secure BR 4-NS / 1.3.1	Schott Technical Glassolution GmbH
3	BR 4-NS	Mono	96	44	Novalay secure BR 4-NS / 1.5.4	Schott Technical Glassolution GmbH
4	BR 4-NS	Iso	93	50	Novalay secure BR 4-NS / 1.6.6	Schott Technical Glassolution GmbH
5	BR 4-NS	Mono	53	25	SILATEC BR 4-NS 25/52	Silatec GmbH

Durchschusshemmende Verglasung, Klasse BR 4-S nach EN 1063 / *Bullet resistant glazing, Class BR 4-S according EN 1063*
Prüfzertifikat S 11 0032-02 FB 4-S, Beschussamt Ulm / *Testcertificat S 11 0032-02 FB 4-S, Department of ballistics Ulm*

Pos. Pos.	Klasse / Class (EN 1063)	Mono/Iso Single/Ins	Masse / Weight (kg/m ²)	Dicke / Thickness (mm)	Bezeichnung / Designation	Hersteller / Manufacturer
6	BR 4-S	Mono	63	36	P8B-17	Flachglas Markenkreis GmbH
7	BR 4-S	Iso	68	36	BR 4-S-21	Flachglas Markenkreis GmbH
8	BR 4-S	Iso	78	50	P8B-27	Flachglas Markenkreis GmbH
9	BR 4-S	Iso	90	50	SGG STADIPT CP-HN 432-S	Saint Gobain GmbH
10	BR 4-S	Iso	67	39	SANCO SAFE BR 4-S-ISO-0-39	Glas Trösch GmbH
11	BR 4-S	Mono	80	33	Multistop -BR4-S-0-33	Glas Trösch GmbH
12	BR 4-S	Iso	72	41	ipasafe BR 4-S Isolierglas	Interpane Sicherheitsglas GmbH & Co
13	BR 4-S	Iso	68	43	Multipact 41 BR 4-S Isolierglas	Glaswerke Arnold GmbH

Fenster / Türen, durchschusshemmend
Windows / doors, bullet resistant

WICLINE 65 / WICSTYLE 65

Durchschusshemmende, nicht transparente Füllung nach DIN EN 1522

Klasse FB 4-NS

Bullet resistant, opaque infill according DIN EN 1522

Class BR 4-NS

Prüfzertifikat S 11 0032-01 FB 4-NS / *Testcertificat S 11 0032-01 FB 4-NS*
Prüfzertifikat S 11 0032-02 FB 4-S / *Testcertificat S 11 0032-02 FB 4-S*
Beschussamt Ulm / *Department of ballistics Ulm*

Pos. Pos.	Klasse / Class (EN 1522)	Mono / Iso Single / Ins	Masse / Weight (kg/m ²)	Dicke / Thickness (mm)	Bezeichnung / Designation	Hersteller / Manufacturer
14	FB 4-NS	Iso	65	40	Seropal-Paneel	Pohltec GmbH

Hinweis:

Pos.14, durchschusshemmendes, 2-lagiges Paneel mit speziellem Decklagenaufbau auf der Beschussseite aussen.

Note:

Pos.14, bullet resistant double layer panel with special cover sheet compound on the assault side.

Türen, durchschusshemmend

Übersicht

Doors, bullet resistant

Overview

Pos. Pos.	Artikel Item	Werkstoff Material	Verwendung / Kombination Application / Combination
Profile / Profiles			
1	3991253	Al	Blendrahmen - Festverglasung Frame - Fixed glazing
2	3991254	Al	Blendrahmen - Fensterflügel Frame - Window sash
3	3991255	Al	Blendrahmen - Türe einwärts Frame - Door inwards
4	3991256	Al	Türe einwärts - Stulp ohne Aufsatzprofil einwärts Falzverbreiterung - besäumt auf 79 mm Door inwards - meeting stile without supplementary profile inwards Rebate widening - trimmed to 79 mm
5	3991257	Al	Blendrahmen - Türe auswärts Frame - Door outwards
6	3991258	Al	Türe auswärts, Stulp ohne Aufsatzprofil auswärts, 122.5 mm Door outwards, meeting stile without supplementary profile outwards 122.5 mm Tür- / Festfeldsockel, umlaufend auswärts - besäumt auf 114 mm Door bottom rail / Fixed field bottom rail, all-around outwards - trimmed to 114 mm Tür- / Festfeldsockel, umlaufend einwärts - besäumt auf 100 mm Door bottom rail / Fixed field bottom rail, all-around inwards - trimmed to 100 mm
7	3991259	Al	Tür- / Festfeldsockel auswärts, mit Kämpferprofil - 177 mm Door bottom rail / Fixed field bottom rail outwards, with transom profile - 177 mm Tür- / Festfeldsockel einwärts, mit Sockelprofil - besäumt auf 170 mm Door bottom rail / Fixed field bottom rail inwards, with bottom rail profile - trimmed to 170 mm Tür- / Festfeldsockel einwärts, mit Kämpferprofil - besäumt auf 163 mm Door bottom rail / Fixed field bottom rail inwards, with transom profile - trimmed to 163 mm
8	3090244	Al	Kämpfer 100/50 Transom 100/50
Zubehör Stückware / Accessories single parts			
9	4980067	Al	Klemmprofil konfektioniert (Länge 120 mm) Clamping profile ready-made (length 120 mm)
10	4980084	Al	Endteil DIN R (Stulpflügel DIN R, ein-/auswärts) End piece DIN R (secondary sash DIN R, in-/outwards)
11	4980085	Al	Endteil DIN L (Stulpflügel DIN L, ein-/auswärts) End piece DIN L (secondary sash DIN L, in-/outwards)
12	6970058	Stahl, rostfrei Stainless steel	Türsockel-Schutzleiste, Garnitur 2-teilig, für 1-flügelige Türen, Festfeld Door bottom rail protection strip, 2-parts set, for single leaf doors, fixed field
13	6970059	Stahl, rostfrei Stainless steel	Türsockel-Schutzleiste, Garnitur 4-teilig, für 2-flügelige Türen Door bottom rail protection strip, 4-parts set, for double leaf doors
Zubehör Meterware / Accessories metre ware			
14	4010090	EPDM, schwarz EPDM, black	Verglasungsdichtung 4 mm außen Glazing gasket 4 mm outside
Beschlag (Türbänder) / Fitting (Door hinges)			
15	6910063	-	Aufschraubband, Dr. Hahn Türband 4, auswärts, Bohrabstand 86 mm Surface mounted hinge, Dr. Hahn door hinge 4, outwards, drilling distance 86 mm
16	6910012	-	Aufschraubband, Dr. Hahn Türband 4, einwärts, Bohrabstand 65 mm Surface mounted hinge, Dr. Hahn door hinge 4, inwards, drilling distance 65 mm
WICPRO			
17	5910081	-	Bohrschablone für Klemmprofile Drilling template for clamping profiles
18	5910087	-	Bohrschablone, für 6910063 auswärts Drilling template, for 6910063 outwards
19	5910059	-	Bohrschablone, für 6910012 einwärts Drilling template, for 6910012 inwards

Türen, durchschusshemmend

Übersicht

Doors, bullet resistant

Overview

Pos. Pos.	Artikel Item	Werkstoff Material	Verwendung / Kombination Application / Combination
Zusätzliches Material (Nicht im WICONA Lieferprogramm enthalten) <i>Additional material (Not part of the WICONA delivery range)</i>			
A	Flach/ <i>flat</i> 30/3	Al	Zuschnitt * RIB-50 mm, Festfeldsockel, Zusatzprofil 1916059/ 1917059, ein-/auswärts <i>Cutting * RIB-50 mm, fixed field bottom rail, supplementary profile 1916059/1917059, in-/outwards</i>
B	Flach/ <i>flat</i> 15/3	Al	Zuschnitt * RIB-50 mm, Festfeldsockel, Türflügel umlaufend, 1926517/ 1927517, ein-/auswärts <i>Cutting * RIB-50 mm, fixed field bottom rail, supplementary profile 1926517/1927517, in-/outwards</i>
C	Flach/ <i>flat</i> 15/3	Al	Zuschnitt * RIB-50 mm, in Schwelle 1926526/ 1927526, auswärts <i>Cutting * RIB-50 mm, in threshold 1926526/ 1927526, outwards</i>
D	Flach/ <i>flat</i> 15/3	Al	Zuschnitt * 3x (FAB-20+(2x45)) mm, Türflügel umlaufend, 1926511/ 1927511, einwärts <i>Cutting * 3x (FAB- 20+(2x45)) mm, leaf profile all-around, 1926511/ 1927511, inwards</i>
E	Flach/ <i>flat</i> 15/3	Al	Zuschnitt * 3x 50 mm vertikal, zu Türflügel 1926511/ 1927511, Stulpbereich unten, auswärts <i>Cutting * 3x 50 mm vertical, for door leaf 1926511/ 1927511, meeting stile bottom area, outwards</i>
F	Flach/ <i>flat</i> 12/6	Al	Zuschnitt * 4x FAH + 4x FAB, zu Abdeckprofil 4930048/ 4930051, Falzbereich, ein-/auswärts <i>Cutting * 4x FAH + 4x FAB, for cover profile 4930048/ 4930051, rebate area, in-/outwards</i>
G	Flach/ <i>flat</i> 8/4	Al	Zuschnitt * (FAB-17) + (2x60) mm, Schwellendichtung, 4910042/ 4910044, ein-/auswärts <i>Cutting * (FAB-17) + (2x60) mm, threshold gasket, 4910042/ 4910044, in-/outwards</i>
H	Flach/ <i>flat</i> 8/3	Al	Zuschnitt * 3x (FAB-24 + (2x60)) mm, Sockelaufsatz, 1926530/ 1927530, einwärts <i>Cutting * 3x (FAB-24+(2x60)) mm, bottom rail supplement, 1926530/ 1927530, inwards</i>
I	Flach/ <i>flat</i> 35/3	Stahl, rostfrei <i>Stainless steel</i>	Zuschnitt * RIB, zu Schwelle 1926526/ 1927526, Klinkung beidseitig einwärts <i>Cutting * RIB, for threshold 1926526/ 1927526, notching both ends inwards</i>

* alle Zuschnittmaße sind ca. Angaben





* all cutting dimensions are approx. indications

Türen, einbruchhemmend

Übersicht einbruchhemmende Bauteile

Doors, burglar resistant

Survey of burglar resistance components

	Artikel Article	Bezeichnung Designation				
EH-Beschlagszubehör EH fitting accessories	6920289	Anbohrschutz PZ für Panikfunktion "B" <i>Drilling protection profile cylinder panic B</i>	X	X	X	X
	6920290	Anbohrschutz PZ für Panikfunktion "E" und Normalfunktion <i>Drilling protection profile cylinder panic E and normal function</i>	X	X	X	X
	6920547	Anbohrschutz RZ für Panikfunktion "B" <i>Drilling protection round cylinder panic B</i>	X	X	X	X
	6920548	Anbohrschutz RZ für Panikfunktion "E" und Normalfunktion <i>Drilling protection round cylinder panic E and normal function</i>	X	X	X	X
	6920793	Schlosskastenabstützung WS 65, Dicke 2 mm <i>Burglar resistant lock box support WS 65, thickness 2 mm</i>	X	X	X	X
	6920794	Schlosskastenabstützung WS 65, Dicke 5 mm <i>Burglar resistant lock box support WS 65, thickness 5 mm</i>	X	X	X	X
	6920345	Schlosskastenabstützung WS 75, Dicke 10 mm <i>Burglar resistant lock box support WS 75, thickness 10 mm</i>	X	X	X	X
	6920346	Schlosskastenabstützung WS 75, Dicke 8 mm <i>Burglar resistant lock box support WS 75, thickness 8 mm</i>	X	X	X	X
	6920255	Befestigungsklammer EH <i>Fixing clamp for burglar resistant</i>				X
	6920273	Endstück Treibriegelstange oben <i>End piece for shoot bolt top</i>	X	X	X	
	6920301	Endstück Treibriegelstange oben und unten <i>End piece for shoot bolt bottom and top</i>				X
	6970060	Stangenführung oben WS 65/75 <i>Rod guide part top WS 65/75</i>				X
	6970061	Stangenführung unten WS 65 <i>Rod guide part bottom WS 65</i>				X
	6970062	Stangenführung unten WS 75 <i>Rod guide part bottom WS 75</i>				X
	6920551	Schließplatte <i>Striker plate</i>				X
	6920549	Abdeckleisten 1 flg, Niro <i>Cover strip single leaf door</i>				X
	6920550	Abdeckleisten 2 flg, Niro <i>Cover strip double leaf door</i>				X
EH-Zubehör EH accessories	4900188	Kennzeichnungsschild <i>Identification marking plate</i>	X	X	X	X
	4910074	EPDM Trockensicherung WS 65 <i>Infill Protection WS 65</i>			X	
	4910076	EPDM Trockensicherung WS 75 <i>Infill Protection WS 75</i>			X	
	4930076	ABS Abdeckprofil Bandseitensicherung WS 65 <i>Cover profile burglar resistant (hinge sided interlock WS 65)</i>	X	X	X	X
	4930077	ABS Abdeckprofil Bandseitensicherung WS 75 <i>Cover profile burglar resistant (hinge sided interlock WS 75)</i>	X	X	X	X
	4930089	ABS Abdeckprofil Falzsicherung WS 65 <i>Cover profile burglar resistant (rebate safeguard WS 65)</i>				X
	4930090	ABS Abdeckprofil Falzsicherung WS 75 <i>Cover profile burglar resistant (rebate safeguard WS 75)</i>				X



Lloyd's Register
LRQA

ZERTIFIKAT

Hiermit wird bescheinigt, dass das Qualitätsmanagementsystem von:

**Sapa Building Systems GmbH
Einsteinstr. 61, 89077 Ulm
Deutschland**

durch Lloyd's Register Quality Assurance geprüft und bewertet wurde
und den folgenden Normen zum Qualitätsmanagement entspricht:

**ISO 9001:2008, EN ISO 9001:2008,
DIN EN ISO 9001:2008, SN EN ISO 9001:2008**

Das Qualitätsmanagementsystem ist anwendbar für:

**Entwicklung, Beschaffung und Vertrieb von Aluminiumprofilen
und -systemen für die Bauindustrie.
Lagerung, Kommissionierung, Bearbeitung und Distribution von
Aluminiumprofilen und Zubehör für die Fassaden, Fenster
und Türen. Test- und Prüfzentrum.
Schulungen / Weiterbildung für Metallarbeiter.**

Dieses Zertifikat ist nur in Verbindung mit dem Zertifikatsanhang gültig, wobei dieser Anhang
mit den zugehörigen Niederlassungen die gleiche Referenznummer haben muss.

Zertifikat
Registrier-Nr.: KLN 0924020

Erstmalige Zulassung: 05. November 1993

Bestehendes Zertifikat: 18. Dezember 2014

Dieses Zertifikat ist gültig bis: 31. Oktober 2017

Ausgestellt von: Lloyd's Register Quality Assurance GmbH



Dieses Dokument unterliegt der unten stehenden Bestimmung.

Innere Kanalstr. 15, 50823 Köln, Deutschland, Handelsregister Nr. B 34587

Diese Zertifizierung wurde gemäß den LRQA-Verfahren zur Auditierung und Zertifizierung durchgeführt. Diese Verfahren werden von LRQA überwacht.

Macro Revision 14



Lloyd's Register
LRQA

CERTIFICATE OF APPROVAL

This is to certify that the Quality Management System of:

Sapa Building Systems GmbH
Einsteinstr. 61, 89077 Ulm
Germany

has been approved by Lloyd's Register Quality Assurance
to the following Quality Management System Standards:

ISO 9001:2008, EN ISO 9001:2008,
DIN EN ISO 9001:2008, SN EN ISO 9001:2008

The Quality Management System is applicable to:

**Design, procurement and sales of aluminium sections
and systems for the building and construction industry.**
**Stockholding, compiling, treatment and distribution of aluminium
sections and accessories for façades, windows and doors.**
Prototype build and Test Centre.
Training and education for metal builder.

This certificate is valid only in association with the certificate schedule bearing the
same number on which the locations applicable to this approval are listed.

Approval
Certificate No: KLN 0924020

Original Approval: 05 November 1993

Current Certificate: 18 December 2014

Certificate Expiry: 31 October 2017

Issued by: Lloyd's Register Quality Assurance GmbH



Innere Kanalstr. 15, 50823 Köln, Germany, Handelsregister Nr. B 34587
This approval is carried out in accordance with the LRQA assessment and certification procedures and monitored by LRQA.
Macro Revision 14



Lloyd's Register
LRQA

ZERTIFIKATSANHANG

Sapa Building Systems GmbH Einsteinstr. 61, 89077 Ulm Deutschland

Hauptsitz

Sapa Building Systems GmbH
Einsteinstr. 61
D-89077 Ulm

Tätigkeiten

Entwicklung, Beschaffung und Vertrieb
von Aluminiumprofilen und -systemen für
die Bauindustrie.

Niederlassungen

Technologiezentrum Bellenberg
Am Mühlholz 2
D-89287 Bellenberg

Tätigkeiten

Test- und Prüfzentrum.

Verkaufsbüro Nord-West
Business-Kontor im Hafen
Philosophenweg 31-33
D-47051 Duisburg

Verkauf.

Verkaufsbüro Mitte
Donnersberg Str. 1
D-64646 Heppenheim

Verkauf.

Verkaufsbüro Nord-Ost
Johann-Eck-Str. 2
D-04129 Leipzig

Verkauf.

Seite 1 von 2



Dieses Dokument unterliegt der unten stehenden Bestimmung.

Innere Kanalstr. 15, 50823 Köln, Deutschland, Handelsregister Nr. B 34587

Diese Zertifizierung wurde gemäß den LRQA-Verfahren zur Auditierung und Zertifizierung durchgeführt. Diese Verfahren werden von LRQA überwacht.

Macro Revision 14



Lloyd's Register
LRQA

CERTIFICATE SCHEDULE

Sapa Building Systems GmbH Einsteinstr. 61, 89077 Ulm Germany

Head Office

Sapa Building Systems GmbH
Einsteinstr. 61
D-89077 Ulm

Activities

Design, procurement and sales of aluminium sections and systems for the building and construction industry.

Locations

Technologiezentrum Bellenberg
Am Mühlholz 2
D-89287 Bellenberg

Activities

Prototype build and Test Centre.

Verkaufsbüro Nord-West
Business-Kontor im Hafen
Philosophenweg 31-33
D-47051 Duisburg

Sales.

Verkaufsbüro Mitte
Donnersberg Str. 1
D-64646 Heppenheim

Sales.

Verkaufsbüro Nord-Ost
Johann-Eck-Str. 2
D-04315 Leipzig

Sales.

Page 1 of 2



Innere Kanalstr. 15, 50823 Köln, Germany, Handelsregister Nr. B 34587
This approval is carried out in accordance with the LRQA assessment and certification procedures and monitored by LRQA.
Macro Revision 14



Lloyd's Register
LRQA

ZERTIFIKATSANHANG

Sapa Building Systems GmbH Einsteinstr. 61, 89077 Ulm Deutschland

Niederlassungen

Verkaufsbüro Süd
Einsteinstr. 61
D-89077 Ulm

Sapa Building Systems AG
Gewerbepark
CH-5506 Mägenwil

Sapa Building Systems GmbH
Servicecenter Gerstungen
In der Flur 1
D-99834 Gerstungen

Tätigkeiten

Verkauf.

Verkauf.

Lagerung, Kommissionierung, Bearbeitung
und Distribution von Aluminiumprofilen
und Zubehör für Fassaden, Fenster und
Türen.

Zertifikat
Registrier-Nr.: KLN 0924020

Erstmalige Zulassung: 05. November 1993

Bestehendes Zertifikat: 18. Dezember 2014

Dieses Zertifikat ist gültig bis: 31. Oktober 2017

Seite 2 von 2



Dieses Dokument unterliegt der unten stehenden Bestimmung.

Innere Kanalstr. 15, 50823 Köln, Deutschland, Handelsregister Nr. B 34587

Diese Zertifizierung wurde gemäß den LRQA-Verfahren zur Auditierung und Zertifizierung durchgeführt. Diese Verfahren werden von LRQA überwacht.

Macro Revision 14



Lloyd's Register
LRQA

CERTIFICATE SCHEDULE

Sapa Building Systems GmbH Einsteinstr. 61, 89077 Ulm Germany

Locations

Activities

Verkaufsbüro Süd
Einsteinstr. 61
D-89077 Ulm

Sales.

Hydro Building Systems AG
Gewerbepark
CH-5506 Mägenwil

Sales.

Hydro Building Systems GmbH
Servicecenter Gerstungen
In der Flur 1
D-99834 Gerstungen

Stockholding, compiling, treatment and distribution of aluminium sections and accessories for façades, windows and doors.

Approval
Certificate No: KLN 0924020

Original Approval: 05 November 1993

Current Certificate: 18 December 2014

Certificate Expiry: 31 October 2017

Page 2 of 2



Innere Kanalstr. 15, 50823 Köln, Germany, Handelsregister Nr. B 34587
This approval is carried out in accordance with the LRQA assessment and certification procedures and monitored by LRQA.

**Austria**

5201 Seekirchen
☎ +43 6212 2000
✉ info@wicona.at

Benelux

3400 Landen
☎ +32 11 690316
✉ info@wicona.be
✉ info@wicona.nl

Czech Republic

63900 Brno
☎ +420 543 422030
✉ info@wicona.cz

Denmark

8381 Tilst
☎ +45 7020 2048

España

08195 Sant Cugat del Vallès
Barcelona
☎ +34 902 222323
✉ info@wicona.es

Estonia / Latvia / Lithuania

11317, Tallinn
☎ +37 2657 6635
✉ info@wicona.lt

France

02200 Courmelles
☎ +33 3 23598200
✉ info@wicona.fr

94388 Bonneuil-sur-Marne Cedex
☎ +33 1 45138000

Germany

89077 Ulm
☎ +49 731 3984-0
✉ info@wicona.de

47051 Duisburg
☎ +49 203 45046-0

04315 Leipzig
☎ +49 341 989795-0

64646 Heppenheim
☎ +49 6252 6736-0

Hungary

1031 Budapest
☎ +36 (1) 4533457
✉ info@wicona.hu

Ireland

Dublin 22, Eire
☎ +353 1 4105766
✉ info@wicona.ie

Italia

20063 Cernusco sul Naviglio MI
☎ +39 02 924291
✉ info@wicona.it

Norway

0283 Oslo
☎ +47 22 422200
✉ info@wicona.no

Poland

03-828 Warszawa
☎ +48 22 3308170
✉ info@wicona.pl

Sweden

352 45 Växjö
☎ +46 470 787400
✉ info@wicona.se

Switzerland

5506 Mägenwil
☎ +41 62 88741-41
✉ info@wicona.ch

United Kingdom

Wakefield WF5 9TG
☎ +44 845 6028799
✉ info@wicona.co.uk

Africa / Asia / America

31037 Toulouse
☎ +33 5 61312626
✉ info@wicona-int.com

China

Tongzhou District, Beijing, PRC 101102
☎ +8610 60595686
✉ info@wicona.cn

Qatar

Doha
☎ +974 44 912552
✉ info@wicona-int.com

