

Original Systems[®]Sistema R^{TT}R 62^{TT}
SYSTEM

Sistema Rtt, per porte e finestre si è arricchito dei più avanzati contenuti estetici, tecnologici e funzionali atti a soddisfare tutte le esigenze costruttive e progettuali.

Rtt System for windows and doors, has been enriched of the most esthetical, technological and functional contents to fulfill all the construction and designing demands.

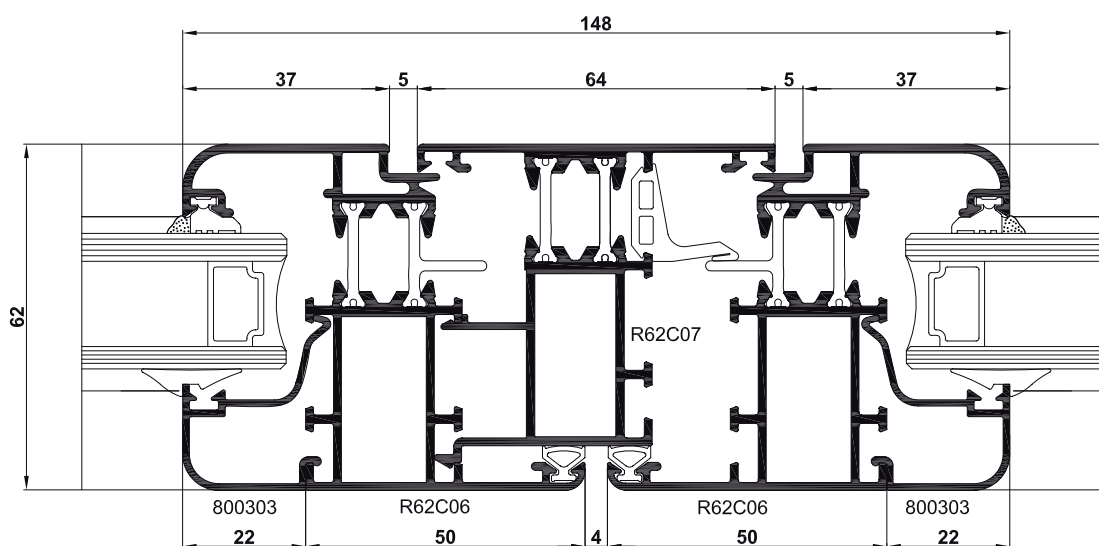
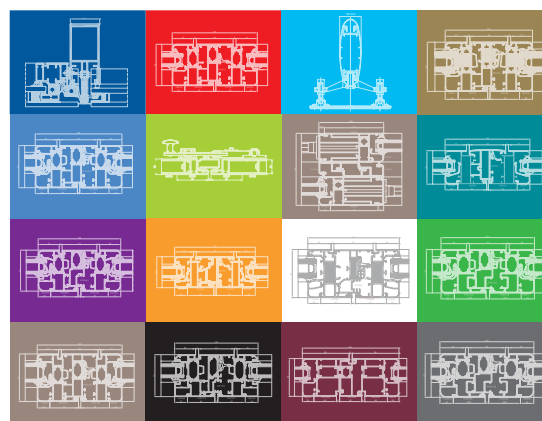

sapa:

R | 62^{TT}
SYSTEM

Finestre e porte a battente a taglio termico
Casement windows and doors with thermal break

About the Sapa Group

Sapa develops, manufactures and markets value added profiles, profile-based building systems and heat-exchanger strip in the light-weight material aluminium and is one of the world's leading manufacturers.

Sapa's business concept is based on close co-operation with its customers, who are primarily located in Europe, North America and Asia. The largest customer segments are the construction, transport, domestic and office, and engineering sectors.

Sapa is organised into six Business Areas: Profiles North Europe, Profiles Central Europe, Profiles South Europe, Profiles North America, Building System and Heat Transfer.

Sapa Profiles

Sapa is the world's leading producer of extruded aluminium profiles and maintains extensive operations in the value-added fabrication of profiles.

The company has 111 presses and more than 12.000 employees and production facilities in 18 countries: Belgium, China, Denmark, France, Germany, Hungary, Italy, Lithuania, Mexico, the Netherlands, Poland, Portugal, Romania, Slovakia, Spain, Sweden, the United Kingdom and the United States, plus sales representation in a number of additional countries.

With footprints in North and Central America, Europe and Asia we can serve customers on a worldwide basis.

Sapa Profili Srl

With 3 plants in Italy and the support of the rest of the group, Sapa Profili Srl is one of the largest extrusion companies within Italy.

Soft- and hard-alloy aluminium extrusions, standard rod and bars, seamless tube (round or shaped), simple or complex aluminium extrusion profiles (drawings), high fin ratio, tight tolerances with superior surface finish quality, or other demanding high-tech applications... There is a simple solution to almost any design problem: aluminium profiles by Sapa. The solutions are based on our unique experience in extrusion and our focus on the local market.

Sapa Profili Srl strategy is providing its customers with expertise, high quality and resources, releasing capacity to allow them to concentrate on their core operations. It's all about creating competitive, comprehensive solutions.

Il gruppo Sapa

Sapa sviluppa, produce e commercializza profili a valore aggiunto, profili per l'edilizia e scambiatori di calore in alluminio. Sapa è un leader tra i produttori nel mondo.

Un elemento determinante per il concetto di business di Sapa è la stretta collaborazione con il cliente maggiormente basati in Europa, Nord America ed Asia. I segmenti di mercato maggiori sono quelli dell'edilizia, il settore trasporti, casa ed uffici ed il settore della meccanica.

La Sapa è suddivisa in sei aree: Profili Nord Europa, Profili Europa centrale, Profili Sud Europa, Profili Nord America, Sistemi per l'edilizia ed il settore per gli scambiatori di calore.

Sapa Profili

Sapa è il maggior produttore di profili estrusi al mondo.

Questa nuova azienda dispone di 111 presse con oltre 12.000 dipendenti e con centri di produzione in 18 paesi: Belgio, Cina, Danimarca, Francia, Germania, Ungheria, Italia, Lituania, Messico, Olanda, Polonia, Portogallo, Romania, Slovenia, Spagna, Svezia, Gran Bretagna e negli stati uniti oltre ad avere rappresentanti commerciali in altri paesi.

Grazie alla presenza in America del Nord e Centrale, Europa ed Asia, possiamo servire i clienti in tutto il mondo.

Sapa Profili Srl

Con i 3 stabilimenti produttivi in Italia ed il supporto del resto del gruppo la Sapa Profili Srl diventa uno dei maggiori estrusori in Italia.

Estrusioni di alluminio in lega leggera o dura, profili standard o barrame, tubi tondi o a disegno senza saldature, profili estrusi semplici o complessi a disegno, elevato rapporto di atteratura, tolleranze ristrette con qualità superficiale elevata o qualsiasi altra esigenza per applicazioni high tech... esiste una semplice soluzione a quasi tutte le esigenze di design: profili in alluminio Sapa. Le soluzioni basano sulla nostra esperienza unica e focalizzata sul mercato locale..

La strategia di Sapa Profili Srl è quella di fornire al cliente competenza, qualità superiore e risorse, per permettere loro di concentrarsi sulle proprie operazioni essenziali. Plasmiamo il futuro creando soluzioni comprensive e competitive.

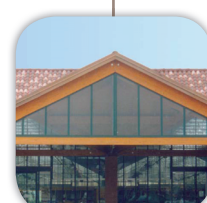

Innovation and Experience: Sapa keys to Build The future

Since its beginnings Sapa has been recognized as an innovator. Through the years, we've balanced experience with innovation. We've listened to our customers, and we are dedicated to providing the tools our customers need to succeed.

Following this spirit, in the market of B&C Sapa offers a comprehensive line of architectural aluminum building products and systems for residential and non-residential buildings framing systems, windows and curtain wall systems.

Due to the accurate product design, in the B&C market, the Sistema R allows the realization of windows and doors with the less possible manufacturing, reducing so the assembling time and achieving the best quality.

This system is present in the South European market since more than 20 years and has allowed Sapa to renovate it constantly with the experience acquired. In this way the Sistema R, the most widespread for windows and doors on the Italian market, has evolved with the most advanced esthetical and technological contents, as to satisfy all planning demands.

For this reason Sapa has realized, within the Sistema R, four continuous bar thermal break series with different sections and performances, all defined in dimensional, technological and esthetical versatility.



Innovazione ed esperienza: le chiavi Sapa per costruire il futuro.

Fin dalle sue origini, Sapa è stata riconosciuta come innovatrice. Attraverso gli anni, abbiamo equilibrato l'esperienza con l'innovazione. Abbiamo ascoltato i nostri clienti e ci siamo dedicati a fornir loro i mezzi necessari per avere successo.

Seguendo questo spirito, nel mercato dell'edilizia, Sapa offre una completa linea di prodotti architettonici in alluminio e sistemi strutturali per edifici residenziali e non, finestre e pareti divisorie.

Nel mercato dell'edilizia, Il sistema R, grazie all'attenta progettazione, consente di realizzare serramenti in alluminio con il minor numero di lavorazioni possibili, riducendo i tempi di assemblaggio nel rispetto della migliore qualità.

La pluri decennale presenza sul mercato sud europeo di questo sistema ha permesso a Sapa di rinnovarlo costantemente nel tempo utilizzando l'esperienza acquisita negli anni. In questo modo il sistema R, il più diffuso e venduto, per porte e finestre, sul mercato italiano, si è arricchito dei più avanzati contenuti estetici, tecnologici e funzionali atti a soddisfare tutte le esigenze costruttive e progettuali.

Per questo Sapa ha realizzato, all'interno del sistema R, quattro serie di profilati a taglio termico a barra continua con diverse sezioni e prestazioni, tutte caratterizzate da polivalenza dimensionale, tecnologica ed estetica.



Original Systems®
sapa:

Le serie dei sistemi di Sapa

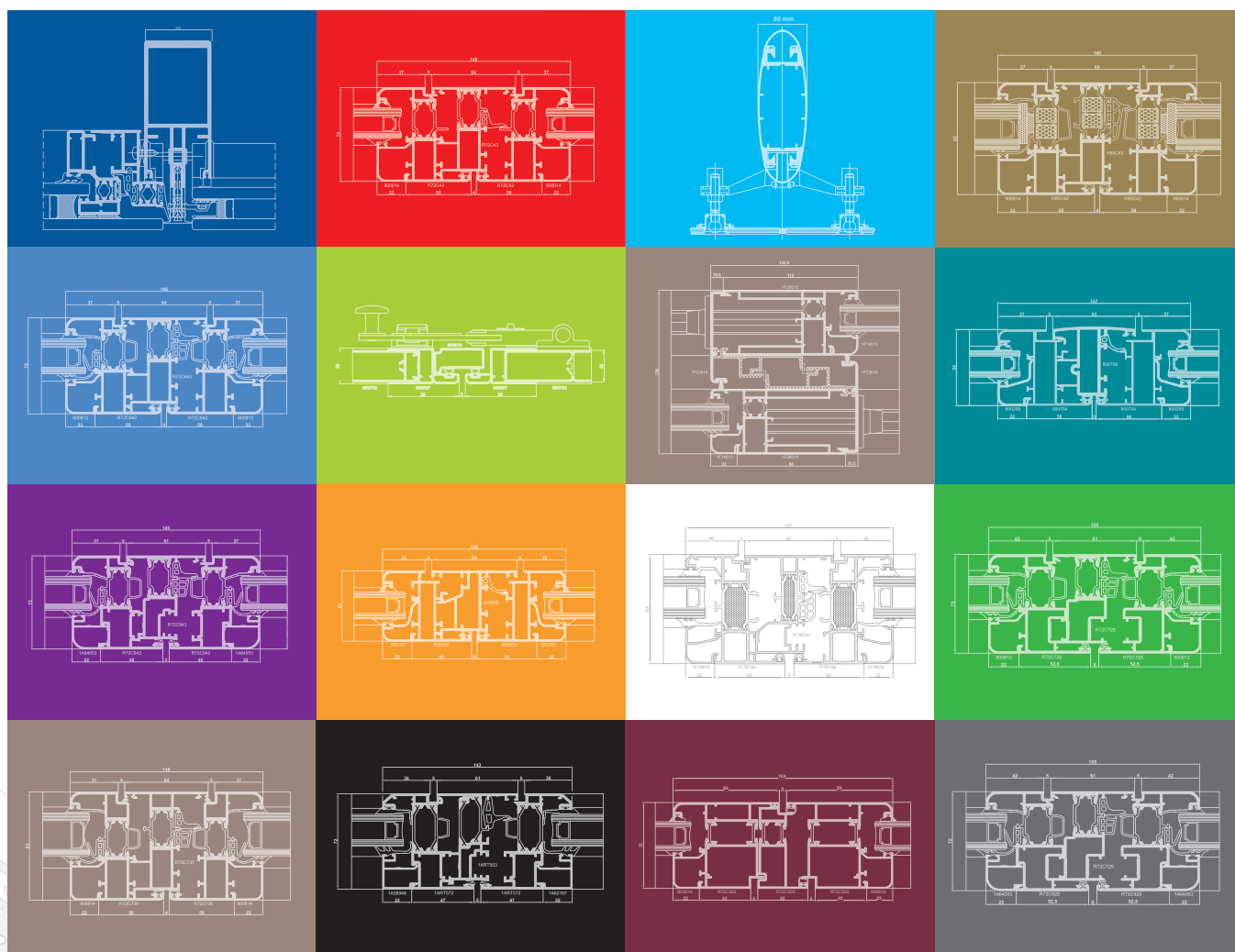

Scegliere con **serenità**

sapa:
Creiamo il futuro

sapa:

Original Systems®

... scegliere con serenità

Original Systems Sapa non è soltanto un profilo in alluminio: è una soluzione completa per tutti gli attori della filiera, con l'obiettivo di fornire il miglior prodotto, col più alto valore aggiunto, dalla bauxite al serramento.

L'assistenza tecnica pre e post vendita, i certificati delle prestazioni dei serramenti, la formazione della Scuola del Serramento di Bareggio (MI), i software di calcolo, le soluzioni Autocad, gli opuscoli tecnici, i cataloghi, la comunicazione ed una capillare e competente Rete di Distribuzione Original Systems Sapa vi danno la serenità di aver fatto la scelta migliore.

soluzioni Original Systems®

Sistema R^{TT}

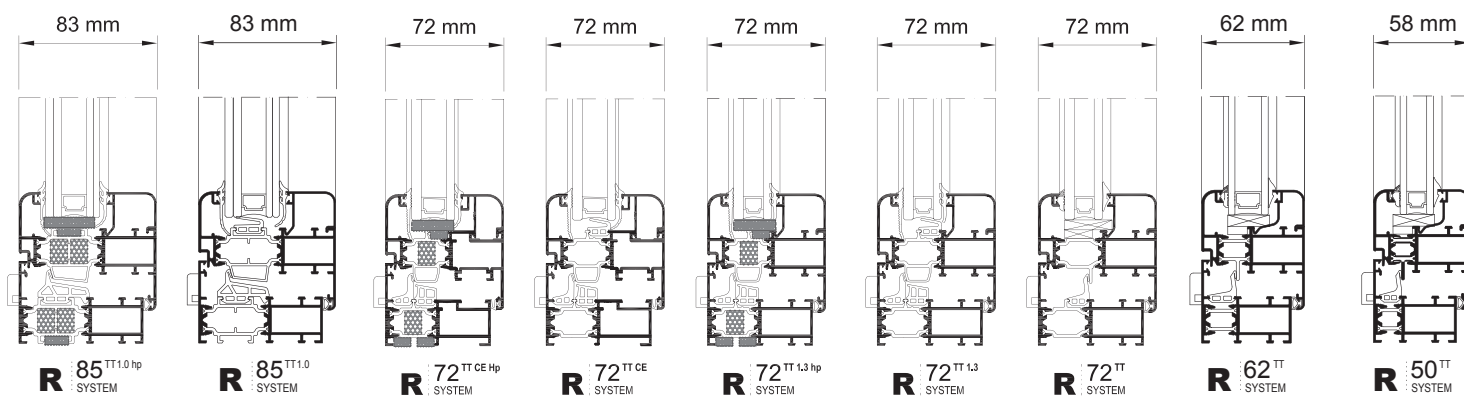

Alfil *next*

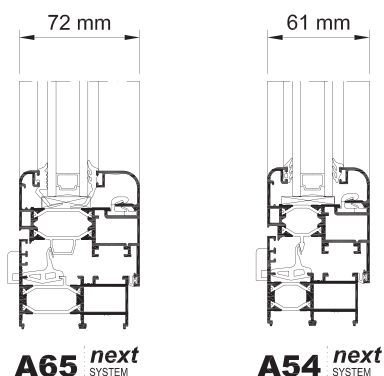

Sistema R

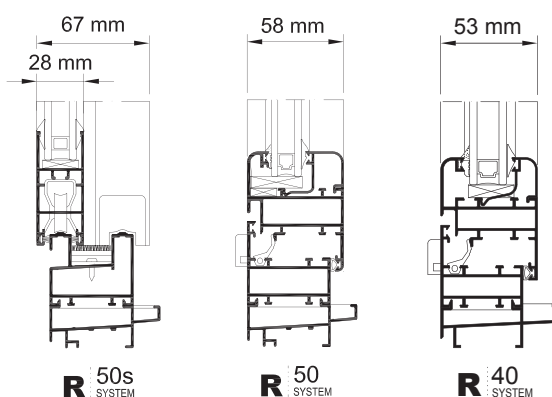

Mr. Hide SYSTEM

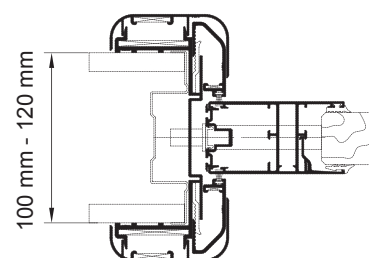

Teknowindow Battente

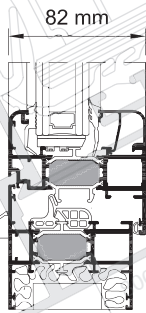

WIN 82su^{TT}
SYSTEM

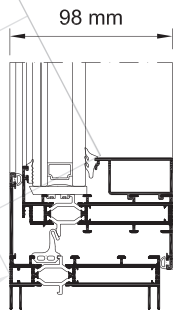

WIN 70^{TT}
SYSTEM

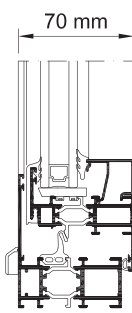

WIN 70^{TT}
SYSTEM

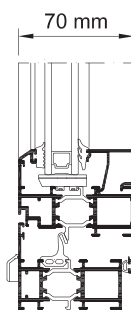

WIN 70^{TT}
SYSTEM

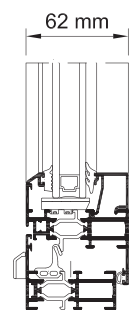

WIN 62^{TT}
SYSTEM

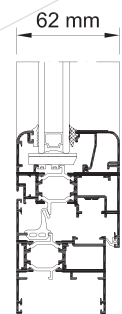

WIN 62^{PTT}
SYSTEM

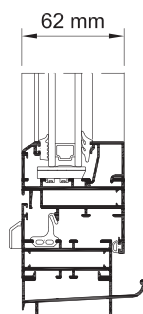

WIN 62
SYSTEM

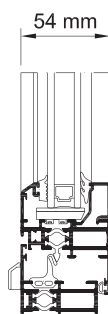

WIN 54^{TT}
SYSTEM

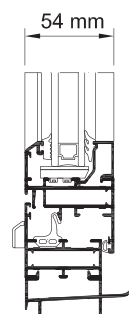

WIN 54
SYSTEM

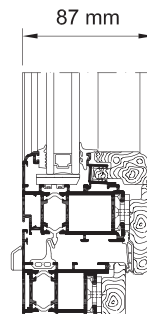

WIN LIGNUM^{TT}
SYSTEM

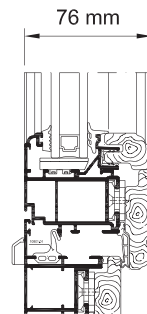

WIN LIGNUM
SYSTEM

Teknowindow Scorrevole

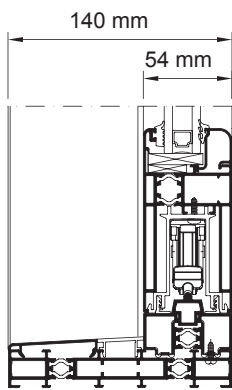

WIN 140sa^{TT}
SYSTEM

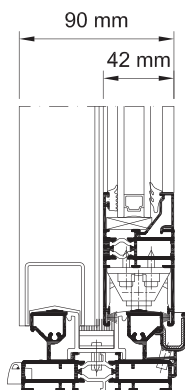

WIN 90s^{TT}
SYSTEM

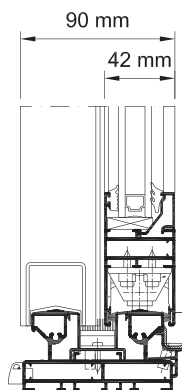

WIN 90s
SYSTEM

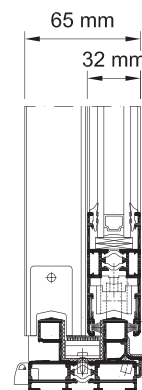

WIN 65s^{TT}
SYSTEM

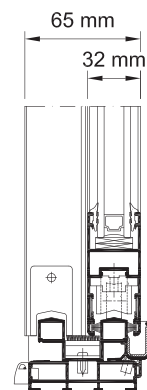

WIN 65s
SYSTEM

Sistemi Oscuranti



Persiane

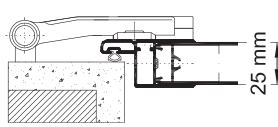

Scurone Venezia

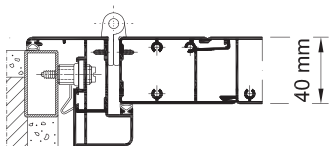

Scurone Padova

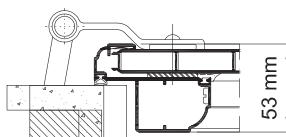

Scurone Romagna

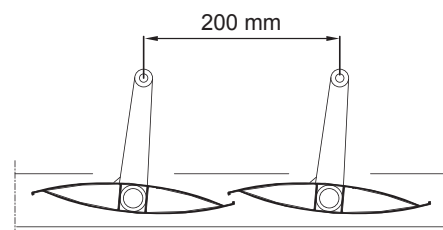

Frangisole

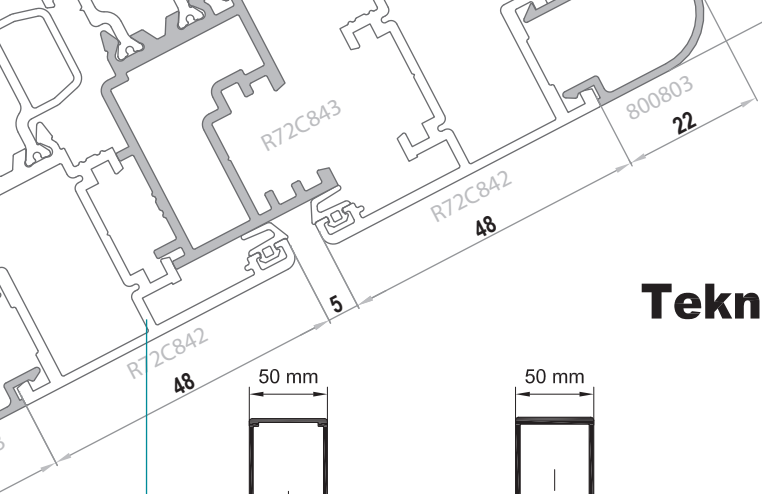

Teknowall

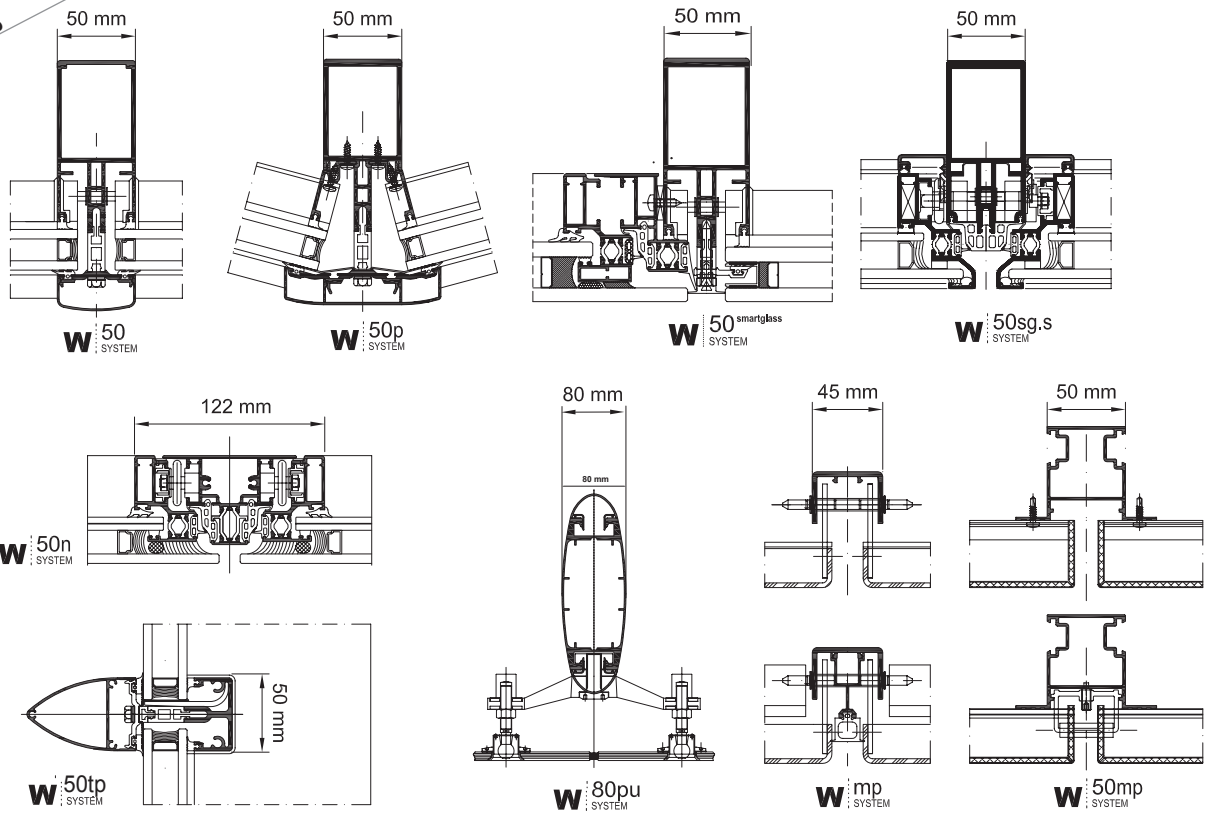

Portoni

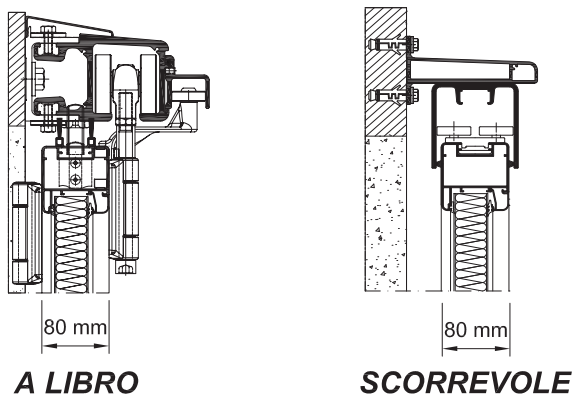

Veranda a Libro

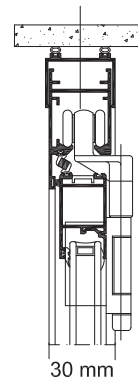

GR 14 SYSTEM

plus SYSTEM

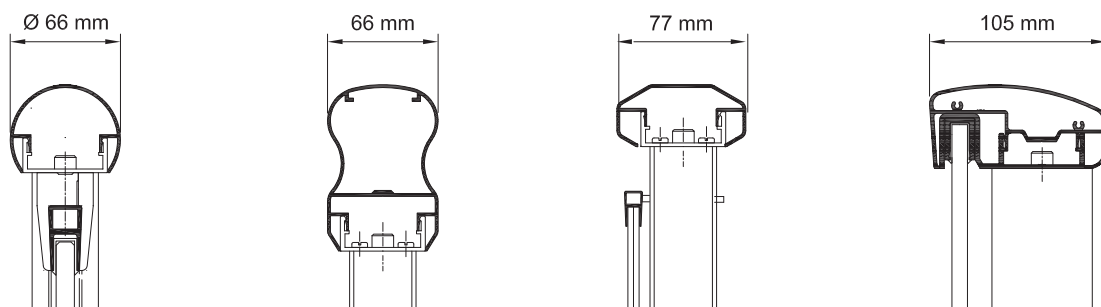

RINGHIERE E BALCONI

Il sistema

Il Sistema R a taglio termico è composto da sei serie di profilati:
R50TT, con telaio fisso da 50 mm ed anta mobile da 58 mm
R62TT, con telaio fisso da 54 mm ed anta mobile da 62 mm
R72TT, con telaio fisso da 64 mm ed anta mobile da 72 mm
R72TT1.3, con telaio fisso da 64 mm ed anta mobile da 72 mm
R72TTCE, sistema a "Camera Europea", con telaio fisso da 64mm ed anta mobile da 72mm
R85TT1.0, con telaio fisso da 75 mm ed anta mobile da 83 mm

I Profilati:

Estrusi in lega di alluminio primario da lavorazione plastica EN AW 6060 UNI-EN 573-3 sottoposti ad un processo di trattamento termico applicato secondo Normativa UNI EN 755-2 (bonifica con tempra in aria alla pressa, seguita da invecchiamento artificiale) per ottenere lo stato T5. Per dettagli tecnici vedere pagina F1-T62-A-08

Trattamenti superficiali:

I trattamenti superficiali di ossidazione anodica, elettrocolorazione e di verniciatura eseguiti negli impianti di proprietà Sapa, sono nel rispetto di quanto previsto dalle normative richieste dai marchi Qualanod (per ossidazione) e Qualicoat (per la verniciatura).

Vetratura:

La scelta ed il tipo di vetro sarà in funzione del suo campo di impiego, per il montaggio attenersi scrupolosamente alle prescrizioni dei produttori.

Il Sistema consente l'inserimento di vetri aventi spessori da 6 a 39 mm per R50TT ; da 10 a 43 mm per R62TT; da 20 a 53 mm per R72TT ed R72TT 1.3; da 14 a 52 per R72TT CE; da 26 a 62 per R85TT 1.0.

Le guarnizioni di tenuta vetro sono in EPDM ed inseribili e sostituibili a serramento assemblato, studiate in vari spessori che, interpolati nel modo idoneo, garantiscono un'adeguata compressione sulla lastra di vetro.

La tassellatura sarà effettuata con appositi tasselli di regolazione e spessoramento aventi posizioni nel serramento ideali e rinforzate. Solo la completa e totale osservanza della tecnica di vetratura potrà garantire uno scatto vincolante e sicuro del fermavetro e la garanzia di durata agli sforzi di normale utenza.

Calcolo dimensioni massime serramenti:

Nel definire le misure massime dei diversi tipi di serramento, si devono considerare oltre agli elementi costruttivi dell'infisso (sezione dei profili e loro campi d'impiego, tipo di attacco al muro, spessore e tipo del vetro), le caratteristiche di utilizzo, nonché le varianti meteorologiche (esposizione dell'infisso, velocità dei venti agenti nella zona, altezza dal suolo alla quale sarà installato l'infisso, ecc.).

Consigliamo a tal fine la consultazione delle prescrizioni Uncsaal.

Attrezzature:

Le attrezzature raccomandate (Comall e Tekna) sono state appositamente progettate e realizzate per le particolari caratteristiche del sistema e per l'applicazione specifica degli accessori a catalogo.

Peso dei profilati:

I pesi indicati sono puramente indicativi (peso teorico ricavato sullo spessore nominale del profilato); Le matrici di estrusione sono soggette ad un normale processo di usura che porta il peso dell'estruso da un minimo (matrice nuova) ad un massimo (matrice usurata al limite delle tolleranze dimensionali).

Tolleranze dimensionali:

Per le tolleranze dimensionali si fa riferimento alla Normativa UNI EN 12020-2

Sigillature occorrenti:

Tra telaio in alluminio e controtelaio; nella vetratura esterna nell'apposita sede sopra la guarnizione di tenuta; nel tassello nodo centrale prima dell'inserimento nel profilato; nei tagli a 45° telaio ed anta prima di assiemare con squadrette; nelle giunzioni telaio ed anta.

NB:

Il mancato impiego, anche parziale, dei prodotti originali, esclude qualsiasi possibilità di rivalsa nei confronti di Sapa.

Al fine di migliorare i propri prodotti, Sapa si riserva la facoltà di apportare, in qualsiasi momento e senza preavviso, le modifiche che riterrà opportuno.

I dati riportati su questo catalogo sono indicativi e non impegnativi.

The system

*The thermal break R system is made up of six series of section bars:
R50TT, with 50 mm fixed frame and 58 mm moving shutter
R62TT, with 54 mm fixed frame and 62 mm moving shutter
R72TT, with 64 mm fixed frame and 72 mm moving shutter
R72TT1.3, with 64 mm fixed frame and 72 mm moving shutter
R72TTCE, "European Chamber" system, with 64 mm fixed frame and 72 mm moving shutter
R85TT1.0, with 75 mm fixed frame and 83 mm moving shutter*

The sections

These are extruded in primary aluminium alloy from EN AW 6060 UNI -EN 573-3 plastic manufacturing, subject to a thermal treatment, applied according to UNI EN 755-2 regulation (austempering through air tempering at the press, followed by artificial ageing) in order to achieve the T5 physical state.

For technical detail refer to page F1-T62-A-08

Surface treatments:

The surface treatments of anodization, electrocoloration and painting carried out in Sapa Italy plants, respect the regulations required by the brands: Qualanod (for anodization) and Qualicoat (for painting).

Glazing:

The choice and the type of glass will depend on its final use.

While assembling, it is essential to follow scrupulously the manufacturers' instructions.

With this System it is possible to insert glass with thickness of 6 to 39 mm for R50TT; 10 to 43 mm R62TT; 20 to 53 mm for R72TT and R72TT 1.3; 14 to 52 for R72TT CE; 26 to 62 for R85TT 1.0 .

The weatherstrips for the glass containment is in EPDM and is conceived in different thickness. If interpolated in the correct way, it assures a proper compression on the glass.

The plugging will be carried out through proper adjusting and shimming plugs, located in ideal and reinforced positions in the fastening. Only the full respect of the glazing technique will assure the proper functioning of the glass beading and will guarantee a long term resistance to the normal uses.

Window maximum dimensions

During the definition of the maximum dimensions of the different sorts of windows, beside the structural elements of the frame (section, uses, juncture to the wall, thickness and sort of glass), the final use and the weather conditions (exposure of the window frame, speed of the wind in the area, distance from the ground where the frame will be installed, etc.) have to be taken into account.

To this purpose, we suggest to consult the Uncsaal regulations.

Equipment:

The recommended equipment (Comall and Tekna) has been planned and realized on purpose according to the particular characteristics of the system and to the specific application of the catalogue accessories.

Weight

Any weight is shown just as an indication (theoretical weight made out of the nominal thickness of the section) The extrusion dies are subject to the natural wear and tear, therefore the section weight varies from a minimum when the dies is new, to a maximum weight when the die is at highest dimensional tolerances limits.

Dimensional allowance

As for the dimensional allowance it is to refer to UNI EN 12020-2 Regulation.

Necessary sealing

Between aluminium frame and subframe; on external side of glass channel; on central node plug before inserting in the profile; in the 45° cut frame and wing before assembly with set square; in the weatherstrips frame and wing.

NB:

Sapa declines any responsibility in case of use or partial use of non original products. With the aim of improving it's products, Sapa reserves the possibility to make changes to this document at any moment and with no advise. The data reported in this catalogue are indicative and not binding.

L'esecuzione del serramento dovrà prevedere tutte le operazioni necessarie per il buon funzionamento del "componente finestra" quali la sigillatura e il bloccaggio sicuro degli angoli, il fissaggio a muro adeguato e, necessariamente, l'utilizzo di accessori e guarnizioni originali. Le lavorazioni, proprio per garantire la giusta applicazione dei particolari, dovranno essere eseguite con attrezzature originali e collaudate sul sistema stesso. Gli scarichi dell'acqua e le asole di aerazione per vetri camera dovranno essere di dimensione e numero ottimale in funzione della dimensione e della tipologia del serramento.

The frame construction must include all the operations necessary for good working of the "window component", such as sealing and safe blocking of corners, suitable wall fixtures and the use of the original accessories and weatherstrips. In order to guarantee the correct application of the parts, works must be carried out with original equipment that has been tested on the system. The size and number of water drains and ventilation slots for double glazing must correspond to the size and type of window frame.

Attenzione

Nelle porte a taglio termico, nei casi in cui ci sia un'eccessiva variazione di temperatura, si possono generare, sulle ante, fenomeni di deformazione dovuta alla diversa dilatazione tra profilato esterno e profilato interno, con conseguente difficoltà di chiusura dell'anta stessa.

Ciò accade perché il sole riscalda i profilati esterni del serramento provocandone la dilatazione che risulta essere differente da quella del profilato interno non riscaldato dal sole, questo provoca delle tensioni che fanno deformare il profilato anta curvandolo verso l'esterno.

Non avendo più l'allineamento anta/telaio si hanno problemi di chiusura, nelle ore di maggiore esposizione si può riscontrare il bloccaggio e/o l'impossibile chiusura della porta.

Questo fenomeno si evidenzia in particolar modo quando si hanno porte d'ingresso con tamponamenti ciechi.

Ad oggi non esistono sistemi a taglio termico che risolvano totalmente il problema. Stiamo studiando, in collaborazione con i maggiori produttori di barrette, soluzioni che possano risolvere questo fenomeno nel prossimo futuro.

Oggi, per ridurre il problema, si possono adottare accorgimenti da valutare di volta in volta.

Attention

In case of sensitive variations of temperature in the Thermal break door solution, deformation of the wings can take place due to the diversified expansion of the internal and external profiles. This can bring to a difficult closing of the wing itself.

Deformation takes place because the sun heats the external profile of the window causing a dilatation which is different from the one of the internal profile. This causes tension that curve the wing profile to the external part. As the wing and the frame are no longer aligned there could be some difficulty in closing the doors. In the hottest hours of the day the door could stall, or it could be impossible to lock the door.

This phenomena is more common when the doors have non glass closures. Up to today there are no thermal break door systems which do not present this problem, although we are studying alternative solutions together with the biggest suppliers of polyamide bars.

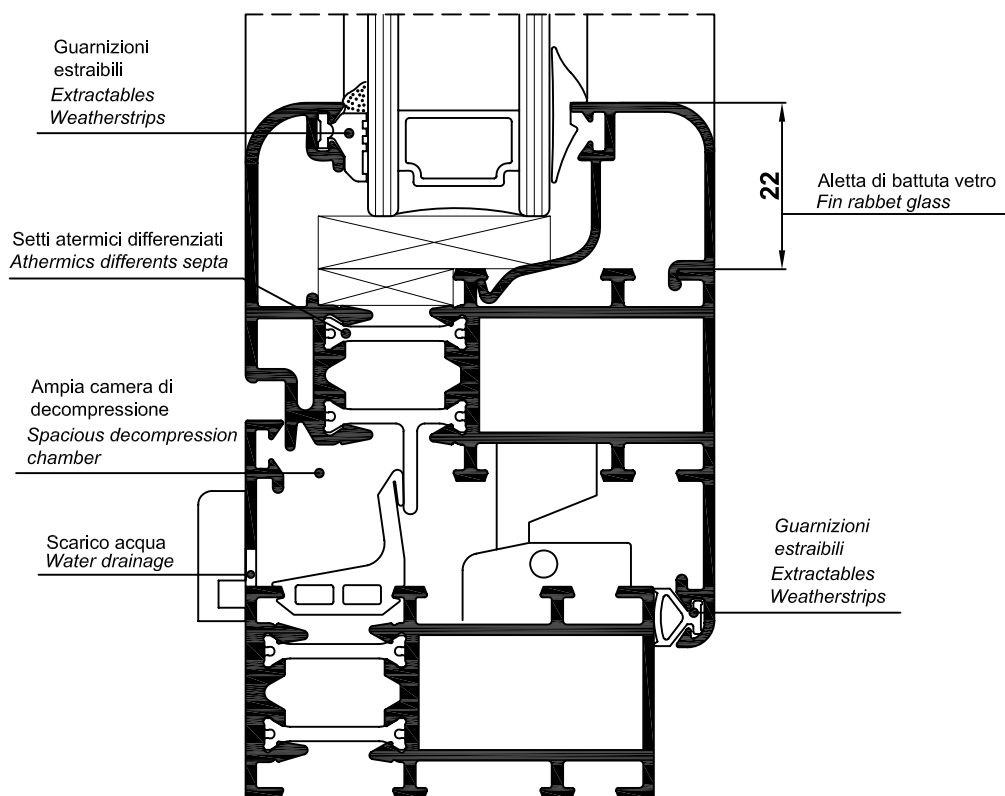

ACCESSORI E GUARNIZIONI

ACCESSORIES AND PACKING

Originali e marchi Sapa, con corpo in lega di alluminio, perni e viteria in acciaio inox, le boccole e i particolari di scorrimento sono in poliammide rinforzato. Le guarnizioni in EPDM sono state studiate con durezza differenti secondo la funzione che dovranno svolgere all'interno del serramento.

They are original and Sapa marked. Their features are: core in aluminium alloy, pins and screw in stainless steel, bushings and sliding elements are in reinforced polyamide. The packing in EPDM has been conceived in different hardness according to its functions in the fastening.

Per garantire il massimo delle prestazioni in funzionalità e durata, il sistema RTT è stato sottoposto ai collaudi rescritti dalle vigenti Normative europee ottenendo ottimi risultati

To guarantee the maximum functionality and wear, R system has been tested according to the running european norms.

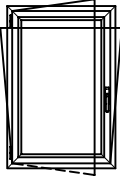
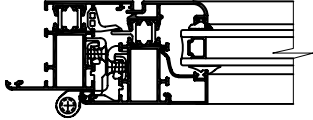
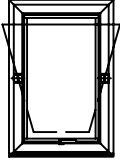
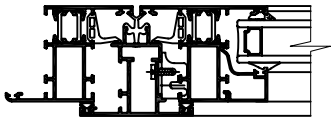
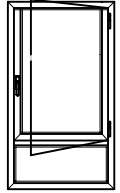
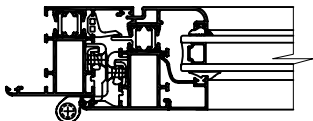
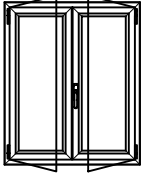
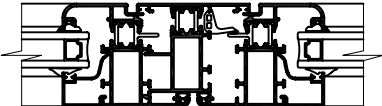
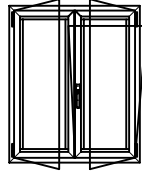
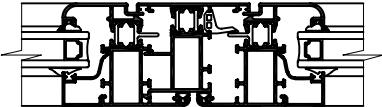
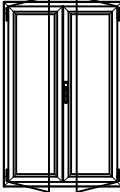
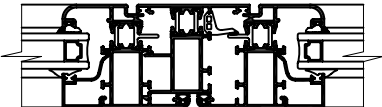
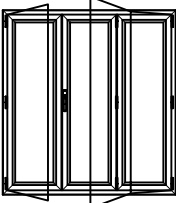
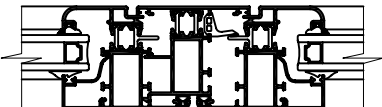
CERTIFICATI		CERTIFICATES					
Sistema System	Tipologia Windows and doors	Dimensioni Dimensions L x H mm	Risultati prove Test values			Sezioni Cross section	Laboratorio Certificato N° Laboratory Certificate Nr.
			Aria Air	Acqua Water	Vento Wind		
R 62 ^{TT} SYSTEM		1092 x 1514	4	E1000	C5		ISTEDIL 683/2002-B
R 62 ^{TT} SYSTEM		1544 x 1644	4	9A	C4		ISTEDIL 0307/2010
R 62 ^{TT} SYSTEM		1104 x 2192	4	E750	C4		ISTEDIL 0868/2008-C
R 62 ^{TT} SYSTEM		1514 x 1684	4	E750	C4		ISTEDIL 683/2002
R 62 ^{TT} SYSTEM		1512 x 1665	4	9A	C5		ISTEDIL 0868/2008-E
R 62 ^{TT} SYSTEM		1644 x 2222	4	9A	C4		ISTEDIL 0868/2008-D
R 62 ^{TT} SYSTEM		1844 x 2244	4	9A	C3		ISTEDIL 1728/2010

- Classificati secondo Normative UNI EN 12207 -
 UNI EN 12208 - UNI EN 12210

- Tests Classify as UNI EN 12207 - UNI EN 12208 -
 UNI EN 12210 standards

Tecnicamente, viene definito "a taglio termico" un profilato metallico che, una volta impiegato nella costruzione di un infisso, presenti il lato rivolto all'interno nettamente diviso dal lato esposto all'esterno per impedire lo scambio termico. Le due parti della sezione devono essere perciò separate da un materiale diverso, con bassi valori di conducibilità termica.

Il taglio termico del sistema R, realizzato con barrette in poliammide rinforzato, si colloca su bassi valori di trasmittanza termica, in linea con i sistemi a taglio termico più avanzati.

Per evitare slittamenti dei vari componenti del profilato a taglio termico è prescritta la pre-zigrinatura dei particolari di bloccaggio prima dell'operazione meccanica di accoppiamento.

A metal section which, when used in the construction of a frame, has the side facing inwards clearly divided from that facing outwards to prevent heat exchange is technically defined "with thermal break". The two parts of the section must therefore be separated by a different material, with low conductivity values.

The thermal break of the R system, produced with reinforced polyamide bars, is placed on low k values (heat transmission coefficient), in line with the most advanced systems with thermal break.

To prevent the components of the thermal break section from slipping, it is advisable to pre-knurl the blocking parts before carrying out the mechanical coupling operation.

Tutti i profilati a taglio termico venduti da Sapa sono sempre riconoscibili.

Il marchio, impresso a laser è stato previsto per essere sempre visibile nel profilato assemblato come dalla figura sottostante

All thermal break sections are always recognizable.

The laser impressed brand is always visible on the assembled sections as you can see in the picture here under



Sapa non risponde di eventuali difetti imputabili ad accoppiamenti non eseguiti nei propri stabilimenti e/o dovuti all'utilizzo di macchine non idonee e/o mal regolate.

Sapa will not be responsible for any incidental defects due to couplings which have not been carried out in its own premises and/or due to the use of not proper and/or not well-regulated machines.

"Valido solo per il territorio ITALIANO"

"Applicable only for Italy"

Requisiti della prestazione energetica degli edifici

Decreto legislativo 29 dicembre 2006, n. 311

Disposizioni correttive ed integrative al decreto legislativo 19 agosto 2005, n. 192, recante attuazione alla direttiva 2002/91/CE, relativa al rendimento energetico nell'edilizia.

Stabilisce i valori massimi della trasmittanza termica dei vetri e delle chiusure trasparenti comprensive di vetri e profilati metallici.

Tabella 4a Valori limite della trasmittanza termica U delle chiusure trasparenti comprensive degli infissi espressa in W/m ² K			
Zona climatica	Dall' 1 gennaio 2006 U (W/m ² K)	Dall' 1 gennaio 2008 U (W/m ² K)	Dall' 1 gennaio 2010 U (W/m ² K)
A	5,5	5,0	4,6
B	4,0	3,6	3,0
C	3,3	3,0	2,6
D	3,1	2,8	2,4
E	2,8	2,4	2,2
F	2,4	2,2	2,0

Tabella 4b Valori limite della trasmittanza U dei vetri espressa in W/m ² K			
Zona climatica	Dall' 1 gennaio 2006 U (W/m ² K)	Dall' 1 luglio 2008 U (W/m ² K)	Dall' 1 gennaio 2011 U (W/m ² K)
A	5,0	4,5	3,7
B	4,0	3,4	2,7
C	3,0	2,3	2,1
D	2,6	2,1	1,9
E	2,4	1,9	1,7
F	2,3	1,7	1,3

Il territorio nazionale è suddiviso nelle seguenti zone climatiche in funzione dei gradi-giorno, indipendentemente dalla ubicazione geografica:

Zona A - Comuni che presentano un numero di gradi-giorno non superiore a 600;

Zona B - Comuni che presentano un numero di gradi-giorno maggiore di 600 e non superiore a 900;

Zona C - Comuni che presentano un numero di gradi-giorno maggiore di 900 e non superiore a 1400;

Zona D - Comuni che presentano un numero di gradi-giorno maggiore di 1400 e non superiore a 2100;

Zona E - Comuni che presentano un numero di gradi-giorno maggiore di 2100 e non superiore a 3000;

Zona F - Comuni che presentano un numero di gradi-giorno maggiore di 3000.

I valori di trasmittanza termica U_f sotto riportati sono i risultati di calcolo eseguiti dall'Istituto ITC-CNR di San Giuliano Milanese, secondo la normativa UNI EN ISO 10077-2 e dall'Istituto ISTDIL secondo la normativa UNI EN 12412-2

The thermal performance values U_f hereunder reported are calculation results from the Institute ITC-CNR of San Giuliano Milanese, in accordance with the norm UNI EN ISO 10077-2 and the Institute ISTDIL, in accordance with the norm UNI EN 12412-2

Nella porzione di tubolarità delimitata dalle barrette del taglio termico si assume:

- Il valore pari a 0,90 per l'emissività dell'alluminio verniciato
- Il valore pari a 0,30 per l'emissività dell'alluminio non verniciato

The equivalent thermal conductivity of the cavity between aluminium and polyamid bars is:

- 0,90 If the aluminium is painted
- 0,30 If the aluminium is mill finish

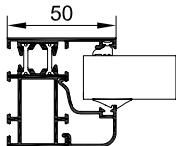
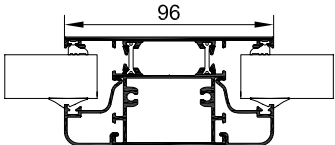
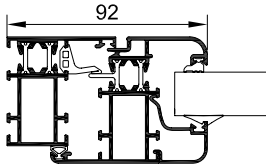
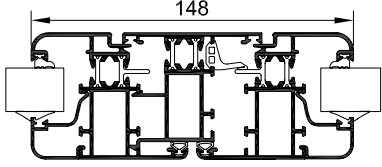
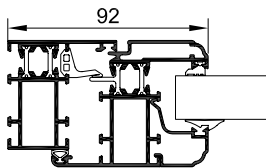
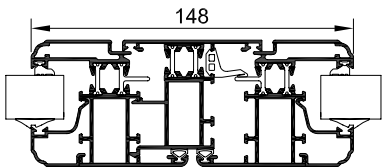
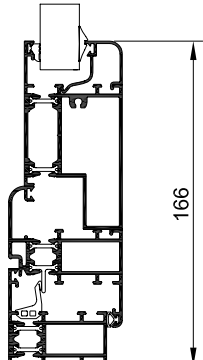
CERTIFICATI		CERTIFICATES					
Sistema System	Sezioni Cross section	Profilati Section	Risultati calcolo Calculus values		Laboratorio Certificato N°. Laboratory Certificate Nr°.	Risultati test in camera calda Hot box test values	Laboratorio Certificato N°. Laboratory Certificate Nr°.
			$U_f = W/m^2 \cdot K$	$\varepsilon = 0.9$ $\varepsilon = 0.3$			
R 62^{TT} SYSTEM		R62C08	3.37	3.25	ITC N°4713/RP/08		
R 62^{TT} SYSTEM		R62C33	3.06	2.78	ITC N°4714/RP/08		
R 62^{TT} SYSTEM		R62C08 R62C06	3.22	3.11	ITC N°4682/RP/08	2.77*	Istedil 71/2010-B
R 62^{TT} SYSTEM		R62C06 R62C07 R62C06	3.50	3.39	ITC N°4715/RP/08	2.85*	Istedil 71/2010-C
R 62^{TT} SYSTEM		R62C57 R62C08	3.37	3.26	ITC N°4717/RP/08		
R 62^{TT} SYSTEM		R62C57 R62C07 R62C57	3.49	3.38	ITC N°4728/RP/08		
R 62^{TT} SYSTEM		R62C18 R62C06 R62C08	3.42	3.25	ITC N°4716/RP/08		

* I valori indicati sono stati ottenuti con profilati verniciati
The values have been obtained with painted profiles

PRESTAZIONI ACUSTICHE ACOUSTIC PERFORMANCES

R 62^{TT}
SYSTEM

Per garantire il massimo delle prestazioni in termini di abbattimento acustico, il sistema RTT è stato sottoposto ai collaudi prescritti dalle vigenti Normative europee ottenendo ottimi risultati

To guarantee the maximum in terms of noise reduction, RTT system has been tested according to the running european norms.

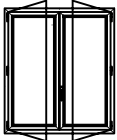
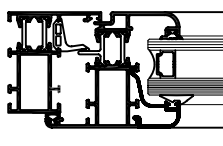
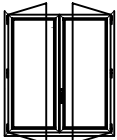
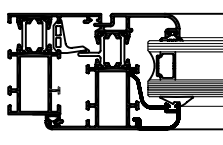
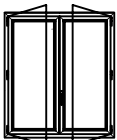
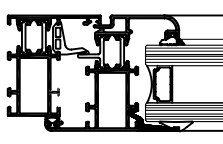
CERTIFICATI		CERTIFICATES			
Sistema System	Tipologia / dimensioni Windows and doors / Dimensions L x H mm	Tipo vetrocamera Double glazing Type	Risultati test Test Values Rw = dB	Sezioni Cross section	Laboratorio Certificato n° Laboratory Certificate nr.
R 62 ^{TT} SYSTEM	 1230x1480	Saint-Gobain Climalit Silance 41/30 Spessore thickness = 30 mm	41		ISTEDIL 1336/2007-D
R 62 ^{TT} SYSTEM	 1230x1480	Saint-Gobain Climalit Silance 44/34 Spessore thickness = 34 mm	42		ISTEDIL 1336/2007-E
R 62 ^{TT} SYSTEM	 1230x1480	Saint-Gobain Climalit Silance 47/39 Spessore thickness = 41 mm	44		ISTEDIL 1336/2007-F

- Collaudi eseguiti secondo Normative UNI EN ISO 140/3 - UNI EN ISO 717/1

- Tests as per UNI EN ISO 140/3 - UNI EN ISO 717/1 standards

Una corretta posa in opera, evita spesso il decadimento delle prestazioni ottenute in laboratorio, curare in maniera appropriata la posa valorizza tutto il processo produttivo dalla progettazione all'installazione.

Fare una pulizia periodica con prodotti neutri riduce notevolmente i rischi di corrosione ed allunga sicuramente la vita dell'infisso. Per una corretta installazione, manutenzione e pulizia dei serramenti, Vi raccomandiamo di consultare le prescrizioni riportate sulle seguenti note tecniche UNCSAAL:

UX42 - "Guida alla posa in opera dei serramenti"

UX10 - "La pulizia delle superfici di serramenti e facciate continue"

A correct installation, often avoids the decay of the performances obtained in the laboratory. Taking appropriate care of the installation increases the value of the whole production process from the planning to the installation.

Cleaning periodically with neutral products reduces remarkably the corrosion risk and extends surely the life of the frame.

For a correct installation, maintenance and cleaning of the sections, we recommend you refer to the prescriptions quoted in the following technical notes of UNCSAAL UX42 and UX10



LEGHE IN ALLUMINIO DA BONIFICA - PROFILATI ESTRUSI
HEAT-TREATABLE ALUMINIUM ALLOYS - EXTRUSION SECTIONS

Leghe / Alloys		6060 UNI EN 573-3				
Composizione chimica normale / Normal chemical compos		Mg 0,4 Si 0,4 Fe 0,2				
Stato / State		0	T1	T5	T6	
Caratteristiche meccaniche <i>Mechanical Characteristics</i>	Carico di rottura a trazione <i>Ultimate tensile stress</i>	R _m N/mm ²	140 Max	120	185	205
	Carico al limite di snervamento <i>Yield point</i>	R _p N/mm ²	80 Max	50	145	165
Caratteristiche fisiche <i>Physical Characteristics</i>	Allungamento <i>Elongation</i>	A %	20	16	11	10
	Peso specifico <i>Specific weight</i>	Kg/dm ³	2,70			
	Conduttività termica a 20°C <i>Heat conductivity at 20°C</i>	W/ (cm °K)	≈ 2,09		≈ 1,75	
	Resistività elettrica a 20°C <i>Electrical resistivity at 20°C</i>	μΩ · cm	≈ 3,14		≈ 3,25	
Coef. di dilatazione termica lineare da 20° a 200°C <i>Linear thermal expansion coefficient from 20° to 200° C</i>		24 · 10 ⁻⁶ K ⁻¹				

Gli accessori originali Sapa, specifici del sistema, sono gli unici che garantiscono nel tempo la qualità del prodotto finale

The original Sapa accessories, specifically designed for the system, are the only ones that guarantee quality of end products through time

AVVERTENZA
NOTE

Per gli articoli indicati con ^(xxx) è possibile scegliere tra diversi produttori, tali articoli sono comunque forniti da Sapa. Le combinazioni possibili sono le seguenti:

For the articles indicating ^(xxx) there is the possibility to choose between different manufacturers although the goods will be supplied by Sapa. Here following the different combinations:

(ABP) - Prodotte da ALUTEC, BMP e PRODUCTA.
(AB) - Prodotte da ALUTEC e BMP.
(AP) - Prodotte da ALUTEC e PRODUCTA.
(BP) - Prodotte da BMP e PRODUCTA.

*(ABP) - Produced by ALUTEC, BMP and PRODUCTA.
(AB) - Produced by ALUTEC and BMP.
(AP) - Produced by ALUTEC and PRODUCTA.
(BP) - Produced by BMP and PRODUCTA.*

Per ordinare tali prodotti, è necessario inserire al termine del codice i seguenti numeri:

To order the articles you will need to indicate following numbers at the end of the code:

01 - Per BMP

01 - For manufacturer BMP

02 - Per ALUTEC

02 - For manufacturer ALUTEC

03 - Per PRODUCTA

03 - For manufacturer PRODUCTA

Esempio: Art. G.0120.EN ^(ABP) La scelta può essere fatta tra BMP (ordinando il codice G.0120.EN.01), ALUTEC (codice G.0120.EN.02) e PRODUCTA (codice G.0120.EN.03).

Example: Article G.0120.EN ^(ABP) the choice may be between BMP (ordering art. G.0120.EN.01), ALUTEC (ordering art. G.0120.EN.02) and PRODUCTA (ordering art. G.0120.EN.03).

Es.2: Art. G.0120.EN ^(AB) La scelta può essere fatta tra BMP (ordinando il codice G.0120.EN.01) ed ALUTEC (codice G.0120.EN.02).

Example n°2: Article G.0120.EN ^(AB) the choice may be between BMP (ordering art. G.0120.EN.01) and Alutec (ordering art. G.0120.EN.02)

Il codice di alcuni accessori comprende due lettere tra parentesi (xx) ciò significa che all'atto dell'ordine occorre specificare la finitura sostituendo le xx con i numeri riportati nella seguente tabella.

In some of the accessory codes you will find 2 letters in brackets (xx), this means that when you will order these articles you will have to specify the finishing replacing the xx with the numbers listed here below:

01=grezzo	} a richiesta
02=ossidato argento	
03=ossidato bronzo	
04=elettrocolore testa di moro	
05=ossidato nero	
08=ossidato oro lucido	
24=PVD oro	
28=PVD inox satinato	
60=verniciato bianco RAL 9010	
61=verniciato avorio RAL 1013	
62=verniciato crema RAL 9001	
65=verniciato verde RAL 6005	
67=verniciato marrone RAL 8017	
69=verniciato nero RAL 9005	
71=verniciato argento RAL 9006	
72=verniciato testa di moro RAL 8019	
75=verniciato bronzo	
79=verniciato nero opaco RAL 9005	
91=verniciato avorio opaco RAL 1013	

01=raw	} upon request
02=anodized silver	
03=anodized bronze	
04=elettrocolore dark brown	
05=anodized black	
08=anodized	
24=PVD gold	
28=PVD glazed steel	
60=white painted RAL 9010	
61=ivory painted RAL 1013	
62=cream painted RAL 9001	
65=green painted RAL 6005	
67=brown painted RAL 8017	
69=black painted RAL 9005	
71=silver painted RAL 9006	
72=dark brown painted RAL 8019	
75=bronze painted	
79=mat black painted RAL 9005	
91=mat ivory painted RAL 1013	

Esempio:

A.4003.ZX.(xx) (Cremonese reversibile per aperture interne) se ordinata **A.4003.ZX.60** verrà fornita verniciata bianco RAL 9010, se invece viene ordinata **A.4003.ZX.69**, verrà fornita Verniciata nero RAL 9005.

For example:

***A.4003.ZX.(xx)** (reversible cremonese bolt for internal opening) if you order **A.4003.ZX.60** you will receive it white painted RAL 9010, if instead you order **A.4003.ZX.69** you will receive it black painted RAL 9005*

ACCESSORI UNIVERSALI
UNIVERSAL ACCESSORIES

ACCESSORI UNIVERSALI
UNIVERSAL ACCESSORIES

Articolo Item	Immagine Picture	Descrizione Description
------------------	---------------------	----------------------------

Articolo Item	Immagine Picture	Descrizione Description
------------------	---------------------	----------------------------

299.703.XX (Alutec)		Cerniera pesante per porta - 3 ali interasse 70 mm 3 wings heavy hinge for door distance between centers mm 70				
		<table border="1"> <tr> <td>R50TT</td> <td>R62TT</td> <td>R72TT</td> </tr> <tr> <td>R72TTCE</td> <td>R72TT1.3</td> <td>R85TT1.0</td> </tr> </table>	R50TT	R62TT	R72TT	R72TTCE
R50TT	R62TT	R72TT				
R72TTCE	R72TT1.3	R85TT1.0				

299.602.XX (Alutec)		Cerniera pesante per porta - 2 ali interasse 60 mm. Heavy hinge for door door - 2 wings distance between centers 60 mm				
		<table border="1"> <tr> <td>R50TT</td> <td>R62TT</td> <td>R72TT</td> </tr> <tr> <td>R72TTCE</td> <td>R72TT1.3</td> <td>R85TT1.0</td> </tr> </table>	R50TT	R62TT	R72TT	R72TTCE
R50TT	R62TT	R72TT				
R72TTCE	R72TT1.3	R85TT1.0				

299.702.XX (Alutec)		Cerniera pesante per porta - 2 ali interasse 70 mm 2 wings heavy hinge for door distance between centers mm 70				
		<table border="1"> <tr> <td>R50TT</td> <td>R62TT</td> <td>R72TT</td> </tr> <tr> <td>R72TTCE</td> <td>R72TT1.3</td> <td>R85TT1.0</td> </tr> </table>	R50TT	R62TT	R72TT	R72TTCE
R50TT	R62TT	R72TT				
R72TTCE	R72TT1.3	R85TT1.0				

299.603.XX (Alutec)		Cerniera pesante per porta - 3 ali interasse 60 mm. Heavy hinge for door door - 3 wings distance between centers mm 60				
		<table border="1"> <tr> <td>R50TT</td> <td>R62TT</td> <td>R72TT</td> </tr> <tr> <td>R72TTCE</td> <td>R72TT1.3</td> <td>R85TT1.0</td> </tr> </table>	R50TT	R62TT	R72TT	R72TTCE
R50TT	R62TT	R72TT				
R72TTCE	R72TT1.3	R85TT1.0				

299.007.XX (Alutec)		Spessore da 7 mm per cerniere pesanti 7 mm shims for heavy hinges				
		<table border="1"> <tr> <td>R50TT</td> <td>R62TT</td> <td>R72TT</td> </tr> <tr> <td>R72TTCE</td> <td>R72TT1.3</td> <td>R85TT1.0</td> </tr> </table>	R50TT	R62TT	R72TT	R72TTCE
R50TT	R62TT	R72TT				
R72TTCE	R72TT1.3	R85TT1.0				

299.862.XX (Alutec)		Cerniera pesante per porta - 2 ali interasse 86 mm. Heavy hinge for door door - 2 wings distance between centers mm 86				
		<table border="1"> <tr> <td>R50TT</td> <td>R62TT</td> <td>R72TT</td> </tr> <tr> <td>R72TTCE</td> <td>R72TT1.3</td> <td>R85TT1.0</td> </tr> </table>	R50TT	R62TT	R72TT	R72TTCE
R50TT	R62TT	R72TT				
R72TTCE	R72TT1.3	R85TT1.0				

299.962.XX (Alutec)		Cerniera pesante per porta - 2 ali interasse 96 mm 2 wings heavy hinge for door distance between centers mm 96				
		<table border="1"> <tr> <td>R50TT</td> <td>R62TT</td> <td>R72TT</td> </tr> <tr> <td>R72TTCE</td> <td>R72TT1.3</td> <td>R85TT1.0</td> </tr> </table>	R50TT	R62TT	R72TT	R72TTCE
R50TT	R62TT	R72TT				
R72TTCE	R72TT1.3	R85TT1.0				

299.863.XX (Alutec)		Cerniera pesante per porta - 3 ali interasse 86 mm. Asse di rotazione a 20 mm. Heavy hinge for door door - 3 wings distance between centers mm 86				
		<table border="1"> <tr> <td>R50TT</td> <td>R62TT</td> <td>R72TT</td> </tr> <tr> <td>R72TTCE</td> <td>R72TT1.3</td> <td>R85TT1.0</td> </tr> </table>	R50TT	R62TT	R72TT	R72TTCE
R50TT	R62TT	R72TT				
R72TTCE	R72TT1.3	R85TT1.0				

299.963.XX (Alutec)		Cerniera pesante per porta - 3 ali interasse 96 mm 3 wings heavy hinge for door distance between centers mm 96				
		<table border="1"> <tr> <td>R50TT</td> <td>R62TT</td> <td>R72TT</td> </tr> <tr> <td>R72TTCE</td> <td>R72TT1.3</td> <td>R85TT1.0</td> </tr> </table>	R50TT	R62TT	R72TT	R72TTCE
R50TT	R62TT	R72TT				
R72TTCE	R72TT1.3	R85TT1.0				

280.068.01 (Alutec)		Albero con losanga per profili da 55 a 64 mm Lozenge rod for profiles from mm 55 to 64				
		<table border="1"> <tr> <td>R50TT</td> <td>R62TT</td> <td></td> </tr> <tr> <td></td> <td></td> <td></td> </tr> </table>	R50TT	R62TT		
R50TT	R62TT					

299.008.XX (Alutec)		Spessore da 8 mm per cerniere pesanti. 8 mm shims for heavy hinges.				
		<table border="1"> <tr> <td>R50TT</td> <td>R62TT</td> <td>R72TT</td> </tr> <tr> <td>R72TTCE</td> <td>R72TT1.3</td> <td>R85TT1.0</td> </tr> </table>	R50TT	R62TT	R72TT	R72TTCE
R50TT	R62TT	R72TT				
R72TTCE	R72TT1.3	R85TT1.0				

299.017.00 (Alutec)		Kit distanziali da 17 a 26 mm per profili T.T. apertura esterna Kit spacers from mm 17 to 26 for T.B. profiles external opening				
		<table border="1"> <tr> <td>R50TT</td> <td>R62TT</td> <td></td> </tr> <tr> <td></td> <td></td> <td></td> </tr> </table>	R50TT	R62TT		
R50TT	R62TT					

CERNIERE E CARDINI
HINGES AND PIVOTS

CERNIERE E CARDINI
HINGES AND PIVOTS

Articolo <i>Item</i>	Immagine <i>Picture</i>	Descrizione <i>Description</i>				
401.024.XX (Alutec)		Cerniera STOPPER portata max 100 Kg <i>Hinge STOPPER capacity max kg 100</i>				
		<table border="1"> <tr> <td>R50TT</td> <td>R62TT</td> <td>R72TT</td> </tr> <tr> <td></td> <td>R72TT1.3</td> <td>R85TT1.0</td> </tr> </table>	R50TT	R62TT	R72TT	
R50TT	R62TT	R72TT				
	R72TT1.3	R85TT1.0				

Articolo <i>Item</i>	Immagine <i>Picture</i>	Descrizione <i>Description</i>				
501.340.XX (Alutec)		Cerniera sfilabile per 3a anta da 50 mm. <i>Slip-off 3rd leaf hinge mm 50</i>				
		<table border="1"> <tr> <td>R50TT</td> <td>R62TT</td> <td>R72TT</td> </tr> <tr> <td></td> <td>R72TT1.3</td> <td>R85TT1.0</td> </tr> </table>	R50TT	R62TT	R72TT	
R50TT	R62TT	R72TT				
	R72TT1.3	R85TT1.0				

401.124.XX (Alutec)		Cerniera STOPPER 3a anta portata max 100 Kg <i>Hinge STOPPER 3rd leaf capacity max kg 100</i>				
		<table border="1"> <tr> <td>R50TT</td> <td>R62TT</td> <td>R72TT</td> </tr> <tr> <td></td> <td>R72TT1.3</td> <td>R85TT1.0</td> </tr> </table>	R50TT	R62TT	R72TT	
R50TT	R62TT	R72TT				
	R72TT1.3	R85TT1.0				

501.342.XX (Alutec)		Cerniera sfilabile maggiorata con contropietra in acciaio inox. <i>Slip-off oversized hinge with stainless steel counterplate.</i>				
		<table border="1"> <tr> <td>R50TT</td> <td>R62TT</td> <td>R72TT</td> </tr> <tr> <td></td> <td>R72TT1.3</td> <td>R85TT1.0</td> </tr> </table>	R50TT	R62TT	R72TT	
R50TT	R62TT	R72TT				
	R72TT1.3	R85TT1.0				

501.013.55 (Alutec)		Rondella spessoramento cerniere sfilabili. <i>Spacing washer for slip off hinges.</i>				
		<table border="1"> <tr> <td>R50TT</td> <td>R62TT</td> <td>R72TT</td> </tr> <tr> <td></td> <td>R72TT1.3</td> <td>R85TT1.0</td> </tr> </table>	R50TT	R62TT	R72TT	
R50TT	R62TT	R72TT				
	R72TT1.3	R85TT1.0				

501.349.XX (Alutec)		Cerniera sfilabile su profili complanari I.E. monoblocco a cinghia da 40 mm <i>Slip-off hinge on coplanar profile I.E. beltshutter winding system mm 40</i>				
		<table border="1"> <tr> <td>R50TT</td> <td>R62TT</td> <td>R72TT</td> </tr> <tr> <td></td> <td>R72TT1.3</td> <td>R85TT1.0</td> </tr> </table>	R50TT	R62TT	R72TT	
R50TT	R62TT	R72TT				
	R72TT1.3	R85TT1.0				

401.002.XX (Alutec)		Cerniera sfilabile con contropietra in acciaio inox. <i>Slip-off hinge with stainless steel counterplate.</i>				
		<table border="1"> <tr> <td>R50TT</td> <td>R62TT</td> <td>R72TT</td> </tr> <tr> <td></td> <td>R72TT1.3</td> <td>R85TT1.0</td> </tr> </table>	R50TT	R62TT	R72TT	
R50TT	R62TT	R72TT				
	R72TT1.3	R85TT1.0				

501.370.XX (Alutec)		Cerniera a pettine a 5 ali <i>R50 Special 5 wings hing</i>				
		<table border="1"> <tr> <td>R50TT</td> <td>R62TT</td> <td>R72TT</td> </tr> <tr> <td></td> <td>R72TT1.3</td> <td>R85TT1.0</td> </tr> </table>	R50TT	R62TT	R72TT	
R50TT	R62TT	R72TT				
	R72TT1.3	R85TT1.0				









501.240.XX (Alutec)		Cerniera sfilabile 3a anta con contropietra in acciaio inox. <i>Slip-off hinge 3rd leaf with stainless steel counterplate.</i>				
		<table border="1"> <tr> <td>R50TT</td> <td>R62TT</td> <td>R72TT</td> </tr> <tr> <td></td> <td>R72TT1.3</td> <td>R85TT1.0</td> </tr> </table>	R50TT	R62TT	R72TT	
R50TT	R62TT	R72TT				
	R72TT1.3	R85TT1.0				











501.310.XX (Alutec)		Cerniera a pettine <i>Special hinge</i>				
		<table border="1"> <tr> <td>R50TT</td> <td>R62TT</td> <td>R72TT</td> </tr> <tr> <td></td> <td>R72TT1.3</td> <td>R85TT1.0</td> </tr> </table>	R50TT	R62TT	R72TT	
R50TT	R62TT	R72TT				
	R72TT1.3	R85TT1.0				

501.330.XX (Alutec)		Cerniera sfilabile da 50 mm. <i>Slip-off hinge mm 50</i>				
		<table border="1"> <tr> <td>R50TT</td> <td>R62TT</td> <td>R72TT</td> </tr> <tr> <td></td> <td>R72TT1.3</td> <td>R85TT1.0</td> </tr> </table>	R50TT	R62TT	R72TT	
R50TT	R62TT	R72TT				
	R72TT1.3	R85TT1.0				

SQUADRETTE D'ANGOLO
CORNER JOINTS

SQUADRETTE D'ANGOLO
CORNER JOINTS

Articolo Item	Immagine Picture	Descrizione Description						
A.2919.NN		Squadretta d'allineamento in nylon su aletta. <i>Nylon alignment corner joint on fin.</i> <table border="1"><tr><td>R50TT</td><td>R62TT</td><td>R72TT</td></tr><tr><td>R72TTCE</td><td>R72TT1.3</td><td>R85TT1.0</td></tr></table>	R50TT	R62TT	R72TT	R72TTCE	R72TT1.3	R85TT1.0
R50TT	R62TT	R72TT						
R72TTCE	R72TT1.3	R85TT1.0						
A.2920.NN		Squadretta d'allineamento in nylon per profili coplanari ed arrotondati. <i>Nylon alignment corner joint for coplanar and rounded profiles.</i> <table border="1"><tr><td>R50TT</td><td>R62TT</td><td>R72TT</td></tr><tr><td>R72TTCE</td><td>R72TT1.3</td><td>R85TT1.0</td></tr></table>	R50TT	R62TT	R72TT	R72TTCE	R72TT1.3	R85TT1.0
R50TT	R62TT	R72TT						
R72TTCE	R72TT1.3	R85TT1.0						
A.5624.AA		Squadretta d'allineamento a cianfrinare in alluminio per tubolarità 27x6.8 <i>Aluminium alignment corner joint for caulking for piping 27x6.8</i> <table border="1"><tr><td>R50TT</td><td>R62TT</td><td>R72TT</td></tr><tr><td>R72TTCE</td><td>R72TT1.3</td><td>R85TT1.0</td></tr></table>	R50TT	R62TT	R72TT	R72TTCE	R72TT1.3	R85TT1.0
R50TT	R62TT	R72TT						
R72TTCE	R72TT1.3	R85TT1.0						
A.5662.AA		Squadretta a cianfrinare per profili con tubolarità 6,7x7,5 <i>Crimped corner joint for profiles piping 6.7x7.5</i> <table border="1"><tr><td>R50TT</td><td>R62TT</td><td>R72TT</td></tr><tr><td>R72TTCE</td><td>R72TT1.3</td><td>R85TT1.0</td></tr></table>	R50TT	R62TT	R72TT	R72TTCE	R72TT1.3	R85TT1.0
R50TT	R62TT	R72TT						
R72TTCE	R72TT1.3	R85TT1.0						
2020 (Monticelli)		Squadretta d'allineamento aletta esterna "FUJI" <i>Alignment corner joint for external rabbet "FUJI"</i> <table border="1"><tr><td>R50TT</td><td>R62TT</td><td>R72TT</td></tr><tr><td>R72TTCE</td><td>R72TT1.3</td><td>R85TT1.0</td></tr></table>	R50TT	R62TT	R72TT	R72TTCE	R72TT1.3	R85TT1.0
R50TT	R62TT	R72TT						
R72TTCE	R72TT1.3	R85TT1.0						
2006 (Monticelli)		Squadretta d'allineamento profilati coplanari "FUJI" <i>Alignment corner joint profiles coplanarities "FUJI"</i> <table border="1"><tr><td>R50TT</td><td>R62TT</td><td>R72TT</td></tr><tr><td>R72TTCE</td><td>R72TT1.3</td><td>R85TT1.0</td></tr></table>	R50TT	R62TT	R72TT	R72TTCE	R72TT1.3	R85TT1.0
R50TT	R62TT	R72TT						
R72TTCE	R72TT1.3	R85TT1.0						
2013 (Monticelli)		Squadretta d'allineamento aletta interna "FUJI" <i>Alignment corner joint for internal rabbet "FUJI"</i> <table border="1"><tr><td>R50TT</td><td>R62TT</td><td>R72TT</td></tr><tr><td>R72TTCE</td><td>R72TT1.3</td><td>R85TT1.0</td></tr></table>	R50TT	R62TT	R72TT	R72TTCE	R72TT1.3	R85TT1.0
R50TT	R62TT	R72TT						
R72TTCE	R72TT1.3	R85TT1.0						
5033 (Monticelli)		Squadretta d'angolo interno profilato R62C62 <i>Corner joint for internal profile R62C62</i> <table border="1"><tr><td>R50TT</td><td>R62TT</td><td>R72TT</td></tr><tr><td></td><td>R72TT1.3</td><td></td></tr></table>	R50TT	R62TT	R72TT		R72TT1.3	
R50TT	R62TT	R72TT						
	R72TT1.3							
0133 (Monticelli)		Squadretta a cianfrinare, spinare e avvitare per profili con tubolarità 6,7x7,5mm <i>Corner joint for piping, crimped and screw to profiles 6,7x7,5mm</i> <table border="1"><tr><td>R50TT</td><td>R62TT</td><td>R72TT</td></tr><tr><td>R72TTCE</td><td>R72TT1.3</td><td>R85TT1.0</td></tr></table>	R50TT	R62TT	R72TT	R72TTCE	R72TT1.3	R85TT1.0
R50TT	R62TT	R72TT						
R72TTCE	R72TT1.3	R85TT1.0						

Articolo Item	Immagine Picture	Descrizione Description						
A.3102.AA		Squadretta d'allineamento profilati mostra <i>Alignment corner joint profiles cornice</i> <table border="1"><tr><td>R50TT</td><td>R62TT</td><td>R72TT</td></tr><tr><td>R72TTCE</td><td>R72TT1.3</td><td>R85TT1.0</td></tr></table>	R50TT	R62TT	R72TT	R72TTCE	R72TT1.3	R85TT1.0
R50TT	R62TT	R72TT						
R72TTCE	R72TT1.3	R85TT1.0						
A.4411.AA		Squadretta in alluminio estruso per tubolarità 10,4x42 <i>Extruded aluminium corner joint piping 10,4x42</i> <table border="1"><tr><td>R50TT</td><td>R62TT</td><td>R72TT</td></tr><tr><td>R72TTCE</td><td>R72TT1.3</td><td>R85TT1.0</td></tr></table>	R50TT	R62TT	R72TT	R72TTCE	R72TT1.3	R85TT1.0
R50TT	R62TT	R72TT						
R72TTCE	R72TT1.3	R85TT1.0						
A.5411.AA		Squadretta in alluminio estruso per tubolarità 15 x 25 <i>Extruded aluminium corner joint piping 15 x 25</i> <table border="1"><tr><td>R50TT</td><td>R62TT</td><td>R72TT</td></tr><tr><td>R72TTCE</td><td>R72TT1.3</td><td>R85TT1.0</td></tr></table>	R50TT	R62TT	R72TT	R72TTCE	R72TT1.3	R85TT1.0
R50TT	R62TT	R72TT						
R72TTCE	R72TT1.3	R85TT1.0						
A.5429.AA		Squadretta in alluminio estruso per profili maggiorati 38.8x29.2 <i>Extruded aluminium corner joint for oversized profiles piping 38.8x29.2</i> <table border="1"><tr><td>R50TT</td><td>R62TT</td><td>R72TT</td></tr><tr><td></td><td>R72TT1.3</td><td>R85TT1.0</td></tr></table>	R50TT	R62TT	R72TT		R72TT1.3	R85TT1.0
R50TT	R62TT	R72TT						
	R72TT1.3	R85TT1.0						
A.5441.AA		Squadretta in alluminio estruso con inserto unificato per tubolarità 15x29,2 <i>Extruded aluminium corner joint with unified ins. piping 15x29.2</i> <table border="1"><tr><td>R50TT</td><td>R62TT</td><td>R72TT</td></tr><tr><td></td><td>R72TT1.3</td><td>R85TT1.0</td></tr></table>	R50TT	R62TT	R72TT		R72TT1.3	R85TT1.0
R50TT	R62TT	R72TT						
	R72TT1.3	R85TT1.0						
A.2921.AA		Squadretta esterna a cianfrinare per tubolarità 16,8x7 <i>External corner joint for crimped 16,8x7</i> <table border="1"><tr><td>R50TT</td><td>R62TT</td><td>R72TT</td></tr><tr><td>R72TTCE</td><td>R72TT1.3</td><td>R85TT1.0</td></tr></table>	R50TT	R62TT	R72TT	R72TTCE	R72TT1.3	R85TT1.0
R50TT	R62TT	R72TT						
R72TTCE	R72TT1.3	R85TT1.0						
A.2906.AA		Squadretta a cianfrinare per profili con tubolarità 15x29,5mm <i>Crimped corner joint for profiles piping 15x29,5mm</i> <table border="1"><tr><td>R50TT</td><td>R62TT</td><td>R72TT</td></tr><tr><td>R72TTCE</td><td>R72TT1.3</td><td>R85TT1.0</td></tr></table>	R50TT	R62TT	R72TT	R72TTCE	R72TT1.3	R85TT1.0
R50TT	R62TT	R72TT						
R72TTCE	R72TT1.3	R85TT1.0						
A.2915.AA		Squadretta d'angolo per profilato R62C115 (tubolarità 15x24,7) <i>Corner joint for profile R62C115 (piping mm 15x24,7)</i> <table border="1"><tr><td>R50TT</td><td>R62TT</td><td>R72TT</td></tr><tr><td></td><td>R72TT1.3</td><td></td></tr></table>	R50TT	R62TT	R72TT		R72TT1.3	
R50TT	R62TT	R72TT						
	R72TT1.3							
VILM 5x14_D8 (Monticelli)		Vite per squadrette 5033,5043,5034 <i>Screw for corner joint 5033,5043,5034</i>						
VILM 5x14_0088 (Monticelli)		Spina per squadrette 5043,5034 <i>Pinned for corner joint 5043,5034</i> <table border="1"><tr><td>R50TT</td><td>R62TT</td><td>R72TT</td></tr><tr><td></td><td>R72TT1.3</td><td>R85TT1.0</td></tr></table>	R50TT	R62TT	R72TT		R72TT1.3	R85TT1.0
R50TT	R62TT	R72TT						
	R72TT1.3	R85TT1.0						

SQUADRETTE D'ANGOLO
CORNER JOINTS

SQUADRETTE D'ANGOLO
CORNER JOINTS

Articolo Item	Immagine Picture	Descrizione Description						
5043 (Monticelli)		Squadretta in alluminio estruso a cianfrinare, spinare e avvitare per profili maggiorati 38,8x29,2mm <i>Extruded aluminium corner joint for piping, crimped and screw to profiles 38,8x29,2mm</i>						
		<table border="1"> <tr> <td>R50TT</td> <td>R62TT</td> <td>R72TT</td> </tr> <tr> <td></td> <td>R72TT1.3</td> <td>R85TT1.0</td> </tr> </table>	R50TT	R62TT	R72TT		R72TT1.3	R85TT1.0
R50TT	R62TT	R72TT						
	R72TT1.3	R85TT1.0						

Articolo Item	Immagine Picture	Descrizione Description						
5034 (Monticelli)		Squadretta in alluminio estruso a cianfrinare, spinare e avvitare con inserto unificato per tubolarità 15x29,2mm <i>Extruded aluminium corner joint for piping, crimped and screw to profiles 15x29,2mm</i>						
		<table border="1"> <tr> <td>R50TT</td> <td>R62TT</td> <td>R72TT</td> </tr> <tr> <td></td> <td>R72TT1.3</td> <td>R85TT1.0</td> </tr> </table>	R50TT	R62TT	R72TT		R72TT1.3	R85TT1.0
R50TT	R62TT	R72TT						
	R72TT1.3	R85TT1.0						

0092 (Monticelli)		Spina in acciaio inox per squadrette <i>Pinned stainless to corner joints</i>						
		<table border="1"> <tr> <td>R50TT</td> <td>R62TT</td> <td>R72TT</td> </tr> <tr> <td>R72TTCE</td> <td>R72TT1.3</td> <td>R85TT1.0</td> </tr> </table>	R50TT	R62TT	R72TT	R72TTCE	R72TT1.3	R85TT1.0
R50TT	R62TT	R72TT						
R72TTCE	R72TT1.3	R85TT1.0						

ACCESSORI COMPLEMENTARI
COMPLEMENTARY ACCESSORIES

ACCESSORI COMPLEMENTARI
COMPLEMENTARY ACCESSORIES

Articolo Item	Immagine Picture	Descrizione Description						
502.002.XX (Alutec)		Angolo stampato per fermavetro arrotondato. <i>Moulded corner for snap-on rounded glass beading.</i>						
		<table border="1"> <tr> <td>R50TT</td> <td>R62TT</td> <td>R72TT</td> </tr> <tr> <td></td> <td>R72TT1.3</td> <td>R85TT1.0</td> </tr> </table>	R50TT	R62TT	R72TT		R72TT1.3	R85TT1.0
R50TT	R62TT	R72TT						
	R72TT1.3	R85TT1.0						

Articolo Item	Immagine Picture	Descrizione Description						
R950.001		Aggancio fermavetri arrotondati. <i>Rounded glass beading coupling.</i>						
		<table border="1"> <tr> <td>R50TT</td> <td>R62TT</td> <td>R72TT</td> </tr> <tr> <td></td> <td>R72TT1.3</td> <td>R85TT1.0</td> </tr> </table>	R50TT	R62TT	R72TT		R72TT1.3	R85TT1.0
R50TT	R62TT	R72TT						
	R72TT1.3	R85TT1.0						

GIUNTI
JOINTS

GIUNTI
JOINTS

Articolo Item	Immagine Picture	Descrizione Description						
A.3204.ZA		Cavallotto di giunzione telai-traversi. <i>Tjoint for frames and transoms</i>						
		<table border="1"> <tr> <td>R50TT</td> <td>R62TT</td> <td>R72TT</td> </tr> <tr> <td>R72TTCE</td> <td>R72TT1.3</td> <td>R85TT1.0</td> </tr> </table>	R50TT	R62TT	R72TT	R72TTCE	R72TT1.3	R85TT1.0
R50TT	R62TT	R72TT						
R72TTCE	R72TT1.3	R85TT1.0						

Articolo Item	Immagine Picture	Descrizione Description						
505.267.01 (Alutec)		Giunto in alluminio estruso. <i>Extruded aluminium joint.</i>						
		<table border="1"> <tr> <td>R50TT</td> <td>R62TT</td> <td>R72TT</td> </tr> <tr> <td></td> <td>R72TT1.3</td> <td>R85TT1.0</td> </tr> </table>	R50TT	R62TT	R72TT		R72TT1.3	R85TT1.0
R50TT	R62TT	R72TT						
	R72TT1.3	R85TT1.0						

MANIGLIE, CREMONESI, ETC.
HANDLES, CREMONE BOLTS, ETC.

MANIGLIE, CREMONESI, ETC.
HANDLES, CREMONE BOLTS, ETC.

Articolo Item	Immagine Picture	Descrizione Description
------------------	---------------------	----------------------------

Articolo Item	Immagine Picture	Descrizione Description
------------------	---------------------	----------------------------

A.4003.ZX.(xx)		Cremonese reversibile per aperture interne interasse 84-100 <i>Reversible cremone bolt for internal opening distance between centers 84-100</i>	R50TT	R62TT	R72TT
				R72TT1.3	R85TT1.0

A.4011.ZX.(xx)		Cremonese reversibile con chiave per anta ribalta interasse 84-100 <i>Reversible cremone bolt with key for tilt and turn distance between centers 84-100</i>	R50TT	R62TT	R72TT
				R72TT1.3	R85TT1.0

A.4004.ZX.(xx)		Cremonese reversibile per anta ribalta interasse 84-100 <i>Reversible cremone bolt for tilt and turn distance between centers 84-100</i>	R50TT	R62TT	R72TT
				R72TT1.3	R85TT1.0

503.463.XX (Alutec)		Maniglia a tavellino VELA reversibile, per apertura esterna con battuta 8 mm, manico smontabile e meccanismo a scatto a 90° <i>VELA flat catch, reversible, for external opening with mm 8 rabbet and removable handle and snap mechanism at 90°</i>	R50TT	R62TT	R72TT
				R72TTCE	R85TT1.0

A.4005.ZX.(xx)		Cremonese reversibile con chiave per apertura interna interasse 84-100 <i>Reversible cremone bolt with key for internal opening distance between centers 84-100</i>	R50TT	R62TT	R72TT
				R72TT1.3	R85TT1.0

503.464.XX (Alutec)		Maniglia a tavellino VELA reversibile, per apertura esterna con battuta 8 mm, manico smontabile e meccanismo a scatto a 90°. Manico in zama <i>VELA flat catch, reversible, for external opening with mm 8 rabbet and removable handle and snap mechanism at 90°. Zamak handle</i>	R50TT	R62TT	R72TT
				R72TTCE	R85TT1.0

A.4006.ZX.(xx)		Cremonese reversibile per apertura esterna interasse 104-108 <i>Reversible cremone bolt for external opening distance between centers 104-108</i>	R50TT	R62TT	R72TT
				R72TT1.3	R85TT1.0

503.963.XX (Alutec)		Maniglia a tavellino linea "600" per sporgere e bilico. <i>"600" flatcatch handle for projecting and pivoting windows.</i>	R50TT	R62TT	R72TT
				R72TT1.3	R85TT1.0

A.4008.ZX.(xx)		Cremonese reversibile aperture interne senza manico interasse 84-100. <i>Reversible cremone bolt without handle for internal opening distance between centers 84-100</i>	R50TT	R62TT	R72TT
				R72TT1.3	R85TT1.0

280.002.XX (Alutec)		Cricchetto universale UNIV. carter, gancio e riscontro in alluminio, particolari di scorrimento in nylon caricato <i>Universal spring latch aluminium carter, hook and striker, nylon sliding parts</i>	R50TT	R62TT	R72TT
				R72TTCE	R85TT1.0

A.4009.ZX.(xx)		Cremonese reversibile per anta ribalta interasse 84-100 senza manico <i>Reversible cremone bolt for tilt and turn without handle distance between centers 84-100</i>	R50TT	R62TT	R72TT
				R72TT1.3	R85TT1.0

503.641.XX (Alutec)		Chiusura a cricchetto regolabile per vasistas <i>Adjustable spring catch for hopper windows</i>	R50TT	R62TT	R72TT
				R72TT1.3	R85TT1.0

A.4010.ZN		Manico estraibile per cremonese <i>Detachable handle cremone bolt</i>	R50TT	R62TT	R72TT
				R72TT1.3	R85TT1.0

503.642.XX (Alutec)		Chiusura a cricchetto per vasistas. <i>Spring latch locking for hopper windows.</i>	R50TT	R62TT	R72TT
				R72TT1.3	R85TT1.0

CHIUSURE
LOCKINGS

CHIUSURE
LOCKINGS

Articolo Item	Immagine Picture	Descrizione Description						
403.801.55 (Alutec)		Manovra per puntali 404.145.05 - 404.141.55 in abbinamento all'asta 900221 <i>Deadlatch for terminals 404.145.05 - 404.141.55 to pair with rod 900221</i>						
		<table border="1"> <tr> <td>R50TT</td> <td>R62TT</td> <td>R72TT</td> </tr> <tr> <td></td> <td>R72TT1.3</td> <td>R85TT1.0</td> </tr> </table>	R50TT	R62TT	R72TT		R72TT1.3	R85TT1.0
R50TT	R62TT	R72TT						
	R72TT1.3	R85TT1.0						

Articolo Item	Immagine Picture	Descrizione Description						
503.160.69 (Alutec)		Serratura con cilindro in zama con perno in acciaio inox. <i>Looking with zamak cylinder with stainless steel pivot.</i>						
		<table border="1"> <tr> <td>R50TT</td> <td>R62TT</td> <td>R72TT</td> </tr> <tr> <td></td> <td>R72TT1.3</td> <td>R85TT1.0</td> </tr> </table>	R50TT	R62TT	R72TT		R72TT1.3	R85TT1.0
R50TT	R62TT	R72TT						
	R72TT1.3	R85TT1.0						

Articolo Item	Immagine Picture	Descrizione Description						
403.806.05 (Alutec)		Manovra a leva con blocchetto di collegamento per puntali 404.145.05 <i>Lever deadlatch with junction block for terminals 404.145.05</i>						
		<table border="1"> <tr> <td>R50TT</td> <td>R62TT</td> <td>R72TT</td> </tr> <tr> <td></td> <td>R72TT1.3</td> <td>R85TT1.0</td> </tr> </table>	R50TT	R62TT	R72TT		R72TT1.3	R85TT1.0
R50TT	R62TT	R72TT						
	R72TT1.3	R85TT1.0						

INCONTRI SERRATURA
LOCK JUNCTION













Articolo Item	Immagine Picture	Descrizione Description						
417.250.55 (Alutec)		Incontro serratura. <i>Lock junction.</i>						
		<table border="1"> <tr> <td>R50TT</td> <td>R62TT</td> <td>R72TT</td> </tr> <tr> <td></td> <td>R72TT1.3</td> <td>R85TT1.0</td> </tr> </table>	R50TT	R62TT	R72TT		R72TT1.3	R85TT1.0
R50TT	R62TT	R72TT						
	R72TT1.3	R85TT1.0						

Articolo Item	Immagine Picture	Descrizione Description						
403.852.05 (Alutec)		Asta di prolunga <i>Extension rod f</i> L = 1000 mm						
		<table border="1"> <tr> <td>R50TT</td> <td>R62TT</td> <td>R72TT</td> </tr> <tr> <td></td> <td>R72TT1.3</td> <td>R85TT1.0</td> </tr> </table>	R50TT	R62TT	R72TT		R72TT1.3	R85TT1.0
R50TT	R62TT	R72TT						
	R72TT1.3	R85TT1.0						

Articolo Item	Immagine Picture	Descrizione Description						
503.094.55 (Alutec)		Chiusura a scatto per anta semifissa. <i>Snap release locking for semi-fixed leaf.</i>						
		<table border="1"> <tr> <td>R50TT</td> <td>R62TT</td> <td>R72TT</td> </tr> <tr> <td></td> <td>R72TT1.3</td> <td>R85TT1.0</td> </tr> </table>	R50TT	R62TT	R72TT		R72TT1.3	R85TT1.0
R50TT	R62TT	R72TT						
	R72TT1.3	R85TT1.0						

INNESTI - PUNTALI - RICONTRI
COUPLINGS - TERMINALS - STRIKERS

INNESTI - PUNTALI - RICONTRI
COUPLINGS - TERMINALS - STRIKERS

Articolo <i>Item</i>	Immagine <i>Picture</i>	Descrizione <i>Description</i>	Articolo <i>Item</i>	Immagine <i>Picture</i>	Descrizione <i>Description</i>												
404.100.02 (Alutec)		Nottolino di chiusura supplementare su astina <i>Rivetting additional locking point on the rod</i>	504.091.05 (Alutec)		Riscontro regolabile per puntali: <i>Adjustable striker for terminals:</i>												
		<table border="1"><tr><td>R50TT</td><td>R62TT</td><td>R72TT</td></tr><tr><td></td><td>R72TT1.3</td><td>R85TT1.0</td></tr></table>	R50TT	R62TT	R72TT		R72TT1.3	R85TT1.0			<table border="1"><tr><td>R50TT</td><td>R62TT</td><td>R72TT</td></tr><tr><td></td><td>R72TT1.3</td><td>R85TT1.0</td></tr></table>	R50TT	R62TT	R72TT		R72TT1.3	R85TT1.0
R50TT	R62TT	R72TT															
	R72TT1.3	R85TT1.0															
R50TT	R62TT	R72TT															
	R72TT1.3	R85TT1.0															
404.101.02 (Alutec)		Incontro di chiusura supplementare su telaio <i>Additional locking point on the sash</i>	504.103.01 (Alutec)		Riscontro per terza chiusura su innesti cremonese: 404.110.55 <i>Striker for 3rd locking on couplings: 404.110.55</i>												
		<table border="1"><tr><td>R50TT</td><td>R62TT</td><td>R72TT</td></tr><tr><td></td><td>R72TT1.3</td><td>R85TT1.0</td></tr></table>	R50TT	R62TT	R72TT		R72TT1.3	R85TT1.0			<table border="1"><tr><td>R50TT</td><td>R62TT</td><td>R72TT</td></tr><tr><td></td><td>R72TT1.3</td><td>R85TT1.0</td></tr></table>	R50TT	R62TT	R72TT		R72TT1.3	R85TT1.0
R50TT	R62TT	R72TT															
	R72TT1.3	R85TT1.0															
R50TT	R62TT	R72TT															
	R72TT1.3	R85TT1.0															
404.110.55 (Alutec)		Coppia innesti cremonese apertura interna su profilo 900221, in nylon <i>Nylon pair of couplings internal opening for profile 900221</i>	504.120.01 (Alutec)		Riscontro con rullino in acciaio inox per chiusure supplementari, apertura interna e anta ribalta. <i>Striker with stainless steel roller for additional lockings internal opening and tilt and turn</i>												
		<table border="1"><tr><td>R50TT</td><td>R62TT</td><td>R72TT</td></tr><tr><td></td><td>R72TT1.3</td><td>R85TT1.0</td></tr></table>	R50TT	R62TT	R72TT		R72TT1.3	R85TT1.0			<table border="1"><tr><td>R50TT</td><td>R62TT</td><td>R72TT</td></tr><tr><td></td><td>R72TT1.3</td><td>R85TT1.0</td></tr></table>	R50TT	R62TT	R72TT		R72TT1.3	R85TT1.0
R50TT	R62TT	R72TT															
	R72TT1.3	R85TT1.0															
R50TT	R62TT	R72TT															
	R72TT1.3	R85TT1.0															
404.141.55 (Alutec)		Coppia puntali in nylon su profilo 900221 <i>Pair of terminals on profile 900221</i>	404.133.01 (Alutec)		Innesti guida apertura esterna per profilato R62C62. <i>Couplings for external opening for profile R62C62.</i>												
		<table border="1"><tr><td>R50TT</td><td>R62TT</td><td>R72TT</td></tr><tr><td></td><td>R72TT1.3</td><td>R85TT1.0</td></tr></table>	R50TT	R62TT	R72TT		R72TT1.3	R85TT1.0			<table border="1"><tr><td></td><td>R62TT</td><td></td></tr><tr><td></td><td></td><td></td></tr></table>		R62TT				
R50TT	R62TT	R72TT															
	R72TT1.3	R85TT1.0															
	R62TT																
404.121.05 (Alutec)		Kit chiusura supplementare per apertura interna ed esterna. <i>Additional lock kit for internal and external opening.</i>	504.132.01 (Alutec)		Innesti guida apertura esterna. <i>Couplings for external opening.</i>												
		<table border="1"><tr><td>R50TT</td><td>R62TT</td><td>R72TT</td></tr><tr><td></td><td>R72TT1.3</td><td>R85TT1.0</td></tr></table>	R50TT	R62TT	R72TT		R72TT1.3	R85TT1.0			<table border="1"><tr><td>R50TT</td><td>R62TT</td><td>R72TT</td></tr><tr><td></td><td>R72TT1.3</td><td>R85TT1.0</td></tr></table>	R50TT	R62TT	R72TT		R72TT1.3	R85TT1.0
R50TT	R62TT	R72TT															
	R72TT1.3	R85TT1.0															
R50TT	R62TT	R72TT															
	R72TT1.3	R85TT1.0															
404.145.05 (Alutec)		Coppia puntali in zama, su profilo 900221 <i>Pair of zamak terminals on profile 900221</i>	504.206.05 (Alutec)		Incontro di chiusura supplementare lato cerniere. <i>U-Bolt for additional locking hinge side</i>												
		<table border="1"><tr><td>R50TT</td><td>R62TT</td><td>R72TT</td></tr><tr><td></td><td>R72TT1.3</td><td>R85TT1.0</td></tr></table>	R50TT	R62TT	R72TT		R72TT1.3	R85TT1.0			<table border="1"><tr><td>R50TT</td><td>R62TT</td><td>R72TT</td></tr><tr><td></td><td>R72TT1.3</td><td>R85TT1.0</td></tr></table>	R50TT	R62TT	R72TT		R72TT1.3	R85TT1.0
R50TT	R62TT	R72TT															
	R72TT1.3	R85TT1.0															
R50TT	R62TT	R72TT															
	R72TT1.3	R85TT1.0															
504.081.55 (Alutec)		Riscontro in nylon con rullino per puntali <i>Nylon striker with roller for terminals</i>															
		<table border="1"><tr><td>R50TT</td><td>R62TT</td><td>R72TT</td></tr><tr><td></td><td>R72TT1.3</td><td>R85TT1.0</td></tr></table>	R50TT	R62TT	R72TT		R72TT1.3	R85TT1.0									
R50TT	R62TT	R72TT															
	R72TT1.3	R85TT1.0															

COMPASSI
ARMS

COMPASSI
ARMS

Articolo Item	Immagine Picture	Descrizione Description
------------------	---------------------	----------------------------

Articolo Item	Immagine Picture	Descrizione Description
------------------	---------------------	----------------------------

A.1812.VV



Braccio limitatore di apertura DX
Opening limiter arm DX

R50TT	R62TT	R72TT
	R72TT1.3	R85TT1.0

406.499.05
(Alutec)



Gruppo articolazione per sporgere rinforzato completo di bracci, portata max kg. 90
Kit for stiffened projecting windows with arms capacity max 90 kg.

L = mm 300

R50TT	R62TT	R72TT
	R72TT1.3	R85TT1.0

A.1813.VV



Braccio limitatore di apertura SX
Opening limiter arm SX

R50TT	R62TT	R72TT
	R72TT1.3	R85TT1.0

406.500.05
(Alutec)



Coppia aste a sporgere portata max 50 kg.
Pair of projecting rods capacity max 50 kg.

L = mm 500

R50TT	R62TT	R72TT
	R72TT1.3	R85TT1.0

A.3905.IA



Coppia bracci ammortizzati sganciabili in acciaio inox per vasistas
Pair of detachable amortized stainless steel arms for hopper windows

250 ≤ H_{ANTA} ≤ 500 mm

R50TT	R62TT	R72TT
	R72TT1.3	R85TT1.0

A.3906.IA



Coppia bracci ammortizzati sganciabili in acciaio inox per vasistas
Pair of detachable amortized stainless steel arms for hopper windows

350 ≤ H_{ANTA} ≤ 1600 mm

R50TT	R62TT	R72TT
	R72TT1.3	R85TT1.0

A.3907.IA



Coppia bracci ammortizzati sganciabili in acciaio inox per vasistas
Pair of detachable amortized stainless steel arms for hopper windows

1000 ≤ H_{ANTA} ≤ 2000 mm

R50TT	R62TT	R72TT
	R72TT1.3	R85TT1.0

506.300.05
(Alutec)



Gruppo articolazione per sporgere comprensivo di coppie di rinforzo in acciaio inox portata max. kg. 75
Kit for projecting windows inclusive of stiffened stainless steel torques capacity max 75 kg.

R50TT	R62TT	R72TT
	R72TT1.3	R85TT1.0

406.300.05
(Alutec)



Coppia aste a sporgere portata max 50 kg.
Pair of projecting rods capacity max 50 kg.

L = mm 300

R50TT	R62TT	R72TT
	R72TT1.3	R85TT1.0

ANTA RIBALTA **R**balta 150
TILT AND TURN

R50TT	R62TT	R72TT
	R72TT1.3	R85TT1.0

ANTA RIBALTA **R**balta 150
TILT AND TURN

R50TT	R62TT	R72TT
	R72TT1.3	R85TT1.0

Articolo Item	Immagine Picture	Descrizione Description
------------------	---------------------	----------------------------

A.1800.VV		<p>Kit base anta ribalta "Rbalta 150" composto da:</p> <ul style="list-style-type: none"> • Rinvio d'angolo in zama con perno di chiusura integrale • Riscontro per chiusura su rinvio d'angolo • innesto cremonese personalizzato • Meccanismo anti falsa manovra • Puntale inferiore dx • Puntale inferiore sx • Perno di chiusura per puntale inferiore • Riscontro per chiusura su puntale • Riscontro orizzontale per puntale inferiore
		<p>"Rbalta 150" tilt and turn basic kit, consisting of :</p> <ul style="list-style-type: none"> • with zama corner locking pin integral • lock striker to corner drive • custom couplings cremone • lock movement • lower terminals dx • lower terminals sx • lock pin for lower terminals • lock striker on terminals • orizontal striker on lower terminals

Articolo Item	Immagine Picture	Descrizione Description
------------------	---------------------	----------------------------

A.1805.VX.(xx)		<p>Kit completo anta ribalta "Rbalta 150" con braccio medio, composto da:</p> <ul style="list-style-type: none"> • Kit base - A.1800.VV • Kit cerniere verniciate - A.1801.VX • Cremonese anta ribalta - A.4004.ZX • Braccio medio (L=550 / 1700) - A.1802.VV <p>"Rbalta 150" tilt and turn complete with standard arm:</p> <ul style="list-style-type: none"> • Kit base - A.1800.VV • Kit hinge painted - A.1801.VX • Tilt and turn cremone - A.4004.ZX • Standard arm (L=550/1700) A.1802.VV
		<p>Kit completo anta ribalta "Rbalta 150" con braccio corto, composto da:</p> <ul style="list-style-type: none"> • Kit base - A.1800.VV • Kit cerniere verniciate - A.1801.VX • Cremonese anta ribalta - A.4004.ZX • Braccio corto (L=350 / 549) - A.1803.VV <p>"Rbalta 150" tilt and turn complete with short arm:</p> <ul style="list-style-type: none"> • Kit base - A.1800.VV • Kit hinge painted - A.1801.VX • Tilt and turn cremone - A.4004.ZX • Short arm (L=350/549) A.1803.VV

Accessori supplementari
Additional accessories

R50TT	R62TT	R72TT
	R72TT1.3	R85TT1.0

Articolo Item	Descrizione Description
A.1801.VX.(xx)	Kit cerniere verniciate portata 150 Kg Hinges kit painted loaded 150 Kg
A.1802.VV	Braccio medio (L=550 / 1700mm) Standard arm (L=550 / 1700mm)
A.1803.VV	Braccio corto (L=350 / 549mm) Short arm (L=350 / 549mm)
A.1804.VV	Braccio supplementare (L>1200mm) Supplementary arm (L>1200mm)
A.1807.VV	Kit chiusura supplementare su asta Supplementary closure point
A.1808.VV	Rinvio d'angolo supplementare inferiore e superiore Supplementary corner drive upper and lower

Accessori supplementari
Additional accessories

R50TT	R62TT	R72TT
	R72TT1.3	R85TT1.0

Articolo Item	Descrizione Description
A.1809.VX.(xx)	Kit cerniere anta affiancata Hinge kit to side leaf
A.1810.VV	Kit paletti anta semifissa Kit of latches for semi-fixed leaf
A.1811.VV	Kit paletti anta semifissa a manovra e leva Kit of latches lever bolt for semi-fixed leaf
A.1812.VV	Braccio limitatore di apertura DX Opening limitator arm DX
A.1813.VV	Braccio limitatore di apertura SX Opening limitator arm SX
A.4004.ZX.(xx)	Cremonese anta ribalta Tilt and turn cremone

MECCANISMI RIBALTA SCORREVOLE

SLIDING TILT MECHANISMS

SCHEMA CON ANTE AFFIANCATE FISSE - SCHEME WITH FIXED SIDE BY SIDE LEAFS

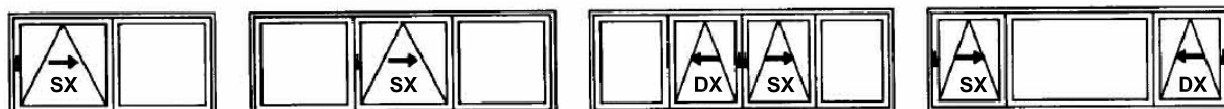

SCHEMA CON ANTE AFFIANCATE APRIBILI - SCHEME WITH OPENABLE SIDE BY SIDE LEAFS

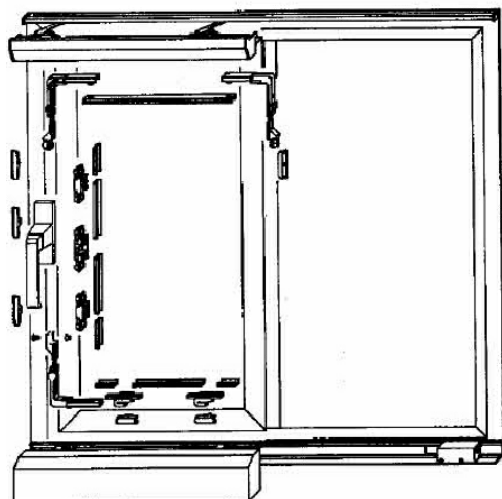
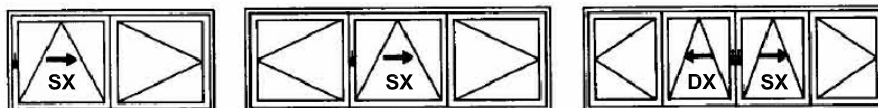

ESEMPIO D'ORDINE SU PROFILI Per anta ribalta scorrevole sinistra con anta fissa avente larghezza telaio 2.700 mm, larghezza anta scorrevole 1.250 mm con finitura bianco RAL 9010 e cremonese .
SI ordina così:
1 confezione base sinistra **419.001.00**
1 confezione di carter e guida **419.007.60**
1 kit di chiusura **419.030.05**
1 cremonese VELA **503.410.60**

EXAMPLE OF ORDER ON PROFILES For sliding left tilt and turn with fixed leaf having a frame width of mm 2.700, sliding leaf width of mm 1.250 with white 9010 finishing and cremone bolt.
You order as follows:
1 left standard kit **419.001.00**
1 coverplate and guide kit **419.007.60**
1 locking mechanism kit **419.030.05**
1 VELA cremone bolt **503.410.60**

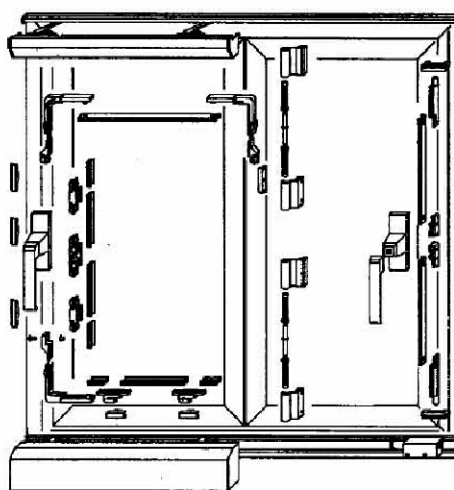

GLI ACCESSORI DELL'ANTA APRIBILE SONO QUELLI STANDARD
THE OPENABLE LEAF STANDARD ACCESSORIES

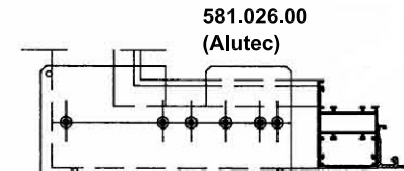
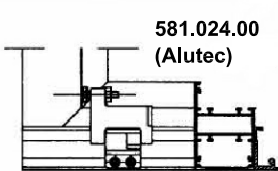
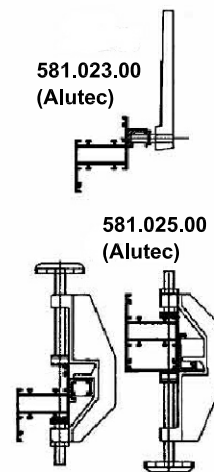

R50TT	R62TT	R72TT
	R72TT1.3	R85TT1.0

Articolo Item	Descrizione Description
------------------	----------------------------

419.001.00 (Alutec)	Confezione base sinistra Left standard kit
419.002.00 (Alutec)	Confezione base destra Right standard kit
419.005.XX (Alutec)	Carter e guide per anta L max 870 mm e telaio L max 2.000 mm Coverplate and guide for leaf L max. mm 870 and frame L max mm 2.000
419.006.XX (Alutec)	Carter e guide per anta L max 1.070 mm e telaio L max 2.400 mm Coverplate and guide for leaf L max 1.070 and frame L max mm 2.400
419.007.XX (Alutec)	Carter e guide per anta L max 1.300 mm e telaio L max 2.860 mm Coverplate and guide for leaf L max 1.300 and frame L max mm 2.860
419.008.XX (Alutec)	Carter e guide per anta L max 1.600 mm e telaio L max 3.460 mm Coverplate and guide for leaf L max 1.600 and frame L max mm 3.460

Articolo Item	Descrizione Description
------------------	----------------------------

419.030.05 (Alutec)	Kit meccanismo di chiusura Locking mechanism kit
503.410.XX (Alutec)	Cremonese VELA reversibile per anta ribalta - interasse 84-100-104 Reversible VELA cremone bolt for tilt and turn - distance between centers 84-100-104
503.411.XX (Alutec)	Cremonese VELA reversibile senza manico per anta ribalta - interasse 84-100-104 Reversible VELA cremone bolt without arm for tilt and turn - distance between centers 84-100-104
503.412.XX (Alutec)	Cremonese VELA reversibile con chiave per anta ribalta - interasse 84-100-104 Reversible VELA cremone bolt with key for tilt and turn - distance between centers 84-100-104
503.847.05 (Alutec)	Manico estraibile per cremonese pressofusa ed estrusa □ 8 mm Detachable handle for die-casting and extruded cremone bolt mm 8 □

MONOBLOCCO
SHUTTER WINDING SYSTEM

Articolo Item	Immagine Picture	Descrizione Description						
402.200.55 (Alutec)		Angolare assiemaggio cassonetto in nylon su profilo 900297 <i>Nylon angle for shutter box assembling on profile 900297</i>						
402.201.55 (Alutec)		- Nero - Black - Bianco - White						
		<table border="1"> <tr> <td>R50TT</td> <td>R62TT</td> <td>R72TT</td> </tr> <tr> <td></td> <td>R72TT1.3</td> <td></td> </tr> </table>	R50TT	R62TT	R72TT		R72TT1.3	
R50TT	R62TT	R72TT						
	R72TT1.3							
410.485.55 (Alutec)		Distanziale per fissaggio stipite monoblocco in nylon su profilo 900274 <i>Nylon spacer for fixing door frame shutter winding system on profile 900274</i>						
		<table border="1"> <tr> <td>R50TT</td> <td>R62TT</td> <td>R72TT</td> </tr> <tr> <td></td> <td>R72TT1.3</td> <td></td> </tr> </table>	R50TT	R62TT	R72TT		R72TT1.3	
R50TT	R62TT	R72TT						
	R72TT1.3							
425.010.00 (Alutec)		Kit manovra a cinghia con avvolgitore da 5,5 m <i>Kit for belt deadlatch coiler with 5,5 m</i>						
425.011.00 (Alutec)		Kit manovra a cinghia con avvolgitore da 10 m <i>Kit for belt deadlatch coiler with 10 m</i>						
		<table border="1"> <tr> <td>R50TT</td> <td>R62TT</td> <td>R72TT</td> </tr> <tr> <td></td> <td>R72TT1.3</td> <td></td> </tr> </table>	R50TT	R62TT	R72TT		R72TT1.3	
R50TT	R62TT	R72TT						
	R72TT1.3							
425.012.00 (Alutec)		Kit manovra ad asta con arganello reversibile <i>Kit for reversible winch road deadlatch</i>						
425.310.00 (Alutec)		Asta per arganello con snodo a 45° <i>Swinging winch rod at 45°</i>						
		<table border="1"> <tr> <td>R50TT</td> <td>R62TT</td> <td>R72TT</td> </tr> <tr> <td></td> <td>R72TT1.3</td> <td></td> </tr> </table>	R50TT	R62TT	R72TT		R72TT1.3	
R50TT	R62TT	R72TT						
	R72TT1.3							
425.112.55 (Alutec)		Coppia mensole in nylon di guida cinghia <i>Pair of nylon guide brackets</i>						
		<table border="1"> <tr> <td>R50TT</td> <td>R62TT</td> <td>R72TT</td> </tr> <tr> <td></td> <td>R72TT1.3</td> <td></td> </tr> </table>	R50TT	R62TT	R72TT		R72TT1.3	
R50TT	R62TT	R72TT						
	R72TT1.3							
425.560.55 (Alutec)		Pannello isolante cassonetto in polistirolo espanso su profili 900297 <i>Nylon bi-hole upper rabbet on profile 900297</i>						
		<table border="1"> <tr> <td>R50TT</td> <td>R62TT</td> <td>R72TT</td> </tr> <tr> <td></td> <td>R72TT1.3</td> <td></td> </tr> </table>	R50TT	R62TT	R72TT		R72TT1.3	
R50TT	R62TT	R72TT						
	R72TT1.3							
507.001.55 (Alutec)		Inviti tapparella. <i>Shutter guides.</i>						
		<table border="1"> <tr> <td>R50TT</td> <td>R62TT</td> <td>R72TT</td> </tr> <tr> <td></td> <td>R72TT1.3</td> <td></td> </tr> </table>	R50TT	R62TT	R72TT		R72TT1.3	
R50TT	R62TT	R72TT						
	R72TT1.3							

MONOBLOCCO
SHUTTER WINDING SYSTEM

Articolo Item	Immagine Picture	Descrizione Description						
510.020.00 (Alutec)		Molla tenuta cassonetto (900297) <i>Clip for shutter box fastening (Prof. 900297)</i>						
		<table border="1"> <tr> <td>R50TT</td> <td>R62TT</td> <td>R72TT</td> </tr> <tr> <td></td> <td>R72TT1.3</td> <td></td> </tr> </table>	R50TT	R62TT	R72TT		R72TT1.3	
R50TT	R62TT	R72TT						
	R72TT1.3							

BILICO
PIVOTING WINDOW

Articolo Item	Immagine Picture	Descrizione Description			
408.213.XX (Alutec)		CONFEZIONE COMPLETA Kit bilico orizzontale a chiusura multiple con cremonese pressofusa <i>COMPLETE KIT Multi-point lockings horizontal pivoting window with die-casting cremone bolt</i>			
		<table border="1"> <tr> <td>R50TT</td> <td>R62TT</td> <td></td> </tr> </table>	R50TT	R62TT	
R50TT	R62TT				
408.214.XX (Alutec)		CONFEZIONE COMPLETA Kit bilico verticale a chiusura multiple con cuscinetto reggispira e cremonese pressofusa. <i>COMPLETE KIT Multi-point locking kit for vertical pivot windows with thrust bearing with die-cast cremone bolt handle</i>			
		<table border="1"> <tr> <td>R50TT</td> <td>R62TT</td> <td></td> </tr> </table>	R50TT	R62TT	
R50TT	R62TT				
408.124.05 (Alutec)		CONFEZIONE COMPLETA Kit bilico verticale a chiusure multiple senza cremonese. <i>COMPLETE KIT Multi-point locking kit for vertical pivot windows without cremone bolt handle</i>			
		<table border="1"> <tr> <td>R50TT</td> <td>R62TT</td> <td></td> </tr> </table>	R50TT	R62TT	
R50TT	R62TT				
508.025.01 (Alutec)		Distanziale fissaggio profilo inversione bilico <i>Spacer for fixing profile inversion pivoting window</i>			
		<table border="1"> <tr> <td>R50TT</td> <td>R62TT</td> <td></td> </tr> </table>	R50TT	R62TT	
R50TT	R62TT				
508.080.XX (Alutec)		Coppia di frizioni per bilico. <i>Pair of clutches for pivoting window.</i>			
		<table border="1"> <tr> <td>R50TT</td> <td>R62TT</td> <td></td> </tr> </table>	R50TT	R62TT	
R50TT	R62TT				
508.081.XX (Alutec)		Coppia di frizioni per bilico verticale con cuscinetto reggispira. <i>Pair of clutches for vertical pivoting windows with thrust bearing.</i>			
		<table border="1"> <tr> <td>R50TT</td> <td>R62TT</td> <td></td> </tr> </table>	R50TT	R62TT	
R50TT	R62TT				

TAPPI
PLUGS

SCARICHI ACQUA
WATER DRAINAGES

Articolo Item	Immagine Picture	Descrizione Description
------------------	---------------------	----------------------------

A.2131.TN^(AP)  Coppia tappi per battuta centrale su profilo R62C07.
Pair of plugs for central rabbet on profile R62C07.

	R62TT	

A.2143.NN^(AP)  Tappo aggiuntivo in nylon per profilo R62C40 in abbinamento con tappo A.2131.TN
Nylon additional plug for profile R62C40 to combine to cod. A.2131.TN

A.2143.NB^(AP)  Nero RAL 9005 / Black RAL 9005
Bianco RAL 9010/ White RAL 9010

R50TT	R62TT	R72TT
	R72TT1.3	R85TT1.0

A.2116.TN  Tappo aggiuntivo in nylon su profilo R62C48 in abbinamento con i tappi cod. A.2131.TN
Nylon additional plug for section R62C48 to combine to cod. A.2131.TN

R50TT	R62TT	R72TT
	R72TT1.3	R85TT1.0

A.2132.NN^(AP)  Coppia tappi per battuta centrale per apertura esterna su profilo R62C52.
Pair of plugs for central rabbet for external opening on profile R62C52.

	R62TT	R72TT
	R72TT1.3	

SPESSORAMENTO VETRI
SHIM FOR GLASSES

Articolo Item	Immagine Picture	Descrizione Description
------------------	---------------------	----------------------------

507.704.55
(Alutec) Tassello spessoramento vetri da:
Shim for glasses:

507.705.55
(Alutec) S = mm 4 marrone - brown

507.706.55
(Alutec)  S = mm 5 nero - black

507.707.55
(Alutec) S = mm 6 grigio - grey

507.708.55
(Alutec) S = mm 7 rosso - red

S = mm 8 verde - green

R50TT	R62TT	

507.709.55
(Alutec)  Tassello spessoramento vetri regolabile con vite.
Adjustable shim for glasses with screw.

R50TT	R62TT	

Articolo Item	Immagine Picture	Descrizione Description
------------------	---------------------	----------------------------

509.270.55
(Alutec)  Valvola scarico acqua in nylon.
Nylon water drainage valve.

R50TT	R62TT	R72TT
R72TTCE	R72TT1.3	R85TT1.0

509.260.55
(Alutec)  Paratempesta in nylon.
Water drain cover of nylon.

- nero - black

- bianco - white

R50TT	R62TT	R72TT
R72TTCE	R72TT1.3	R85TT1.0

509.261.55
(Alutec)  Paratempesta in nylon.
Water drain cover of nylon.

- nero - black

- bianco - white

R50TT	R62TT	R72TT
R72TTCE	R72TT1.3	R85TT1.0

509.264.55
(Alutec)  Paratempesta in nylon.
Water drain cover of nylon.

- nero - black

- bianco - white

R50TT	R62TT	R72TT
R72TTCE	R72TT1.3	R85TT1.0

ATTACCHI ALLA MURATURA
WALL FASTENERS

ATTACCHI ALLA MURATURA
WALL FASTENERS

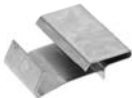
Articolo <i>Item</i>	Immagine <i>Picture</i>	Descrizione <i>Description</i>						
410.100.00 (Alutec)		Molla in acciaio zincato per coprifilo angolare <i>Galvanized steel spring for angular coverwire</i>						
		<table border="1"> <tr> <td>R50TT</td> <td>R62TT</td> <td>R72TT</td> </tr> <tr> <td></td> <td>R72TT1.3</td> <td>R85TT1.0</td> </tr> </table>	R50TT	R62TT	R72TT		R72TT1.3	R85TT1.0
R50TT	R62TT	R72TT						
	R72TT1.3	R85TT1.0						

Articolo <i>Item</i>	Immagine <i>Picture</i>	Descrizione <i>Description</i>						
510.490.55 (Alutec)		Tappo rettangolare copriforo Ø 12 mm in polietilene <i>Rectangular coverhole plug Ø mm 12 made of polyethylene</i>						
510.490.60 (Alutec)		- colore nero - <i>black color</i> - colore bianco - <i>white color</i>						
		<table border="1"> <tr> <td>R50TT</td> <td>R62TT</td> <td>R72TT</td> </tr> <tr> <td></td> <td>R72TT1.3</td> <td>R85TT1.0</td> </tr> </table>	R50TT	R62TT	R72TT		R72TT1.3	R85TT1.0
R50TT	R62TT	R72TT						
	R72TT1.3	R85TT1.0						

410.330.55 (Alutec)		Clip ad infilare per profili angolari. <i>Insert clip for angular profiles.</i>						
		<table border="1"> <tr> <td>R50TT</td> <td>R62TT</td> <td>R72TT</td> </tr> <tr> <td></td> <td>R72TT1.3</td> <td>R85TT1.0</td> </tr> </table>	R50TT	R62TT	R72TT		R72TT1.3	R85TT1.0
R50TT	R62TT	R72TT						
	R72TT1.3	R85TT1.0						

510.481.55 (Alutec)		Distanziale per fissaggio profili 900318 e 900319 <i>Fixing 900318 and 900319</i>						
		<table border="1"> <tr> <td>R50TT</td> <td>R62TT</td> <td>R72TT</td> </tr> <tr> <td>R72TTCE</td> <td>R72TT1.3</td> <td></td> </tr> </table>	R50TT	R62TT	R72TT	R72TTCE	R72TT1.3	
R50TT	R62TT	R72TT						
R72TTCE	R72TT1.3							

410.405.01 (Alutec)		Basetta unificata per regolo mobile in zama pressofusa. <i>Unified plate for adjustable block made of die-casting zamak.</i>						
		<table border="1"> <tr> <td>R50TT</td> <td>R62TT</td> <td>R72TT</td> </tr> <tr> <td></td> <td>R72TT1.3</td> <td>R85TT1.0</td> </tr> </table>	R50TT	R62TT	R72TT		R72TT1.3	R85TT1.0
R50TT	R62TT	R72TT						
	R72TT1.3	R85TT1.0						







510.480.01 (Alutec)		Fissaggio a muro laterale in alluminio estruso. <i>Extruded aluminium lateral wall fastener.</i>						
		<table border="1"> <tr> <td>R50TT</td> <td>R62TT</td> <td>R72TT</td> </tr> <tr> <td></td> <td>R72TT1.3</td> <td>R85TT1.0</td> </tr> </table>	R50TT	R62TT	R72TT		R72TT1.3	R85TT1.0
R50TT	R62TT	R72TT						
	R72TT1.3	R85TT1.0						







510.491.55 (Alutec)		Tappo rotondo copriforo Ø 12 mm in polietilene. <i>Circular coverhole plug Ø mm 12 made of polyethylene.</i>						
		<table border="1"> <tr> <td>R50TT</td> <td>R62TT</td> <td>R72TT</td> </tr> <tr> <td></td> <td>R72TT1.3</td> <td>R85TT1.0</td> </tr> </table>	R50TT	R62TT	R72TT		R72TT1.3	R85TT1.0
R50TT	R62TT	R72TT						
	R72TT1.3	R85TT1.0						

510.415.01 (Alutec)		Regolo mobile. <i>Adjustable block.</i>						
		L = mm 15						
510.420.01 (Alutec)		L = mm 20						
510.430.01 (Alutec)		L = mm 30						
510.445.01 (Alutec)		L = mm 45						
510.460.01 (Alutec)		L = mm 60						
		<table border="1"> <tr> <td>R50TT</td> <td>R62TT</td> <td>R72TT</td> </tr> <tr> <td></td> <td>R72TT1.3</td> <td>R85TT1.0</td> </tr> </table>	R50TT	R62TT	R72TT		R72TT1.3	R85TT1.0
R50TT	R62TT	R72TT						
	R72TT1.3	R85TT1.0						

ATTREZZATURE
TOOLS

ATTREZZATURE
TOOLS

Articolo Item	Immagine Picture	Descrizione Description						
581.021.00 (Alutec)		Attrezzo per posizionamento contropiastra cerniere pesanti e cardini <i>Tool for positioning counterplate for heavy hinges and</i>						
		<table border="1"> <tr> <td>R50TT</td> <td>R62TT</td> <td>R72TT</td> </tr> <tr> <td></td> <td>R72TT1.3</td> <td>R85TT1.0</td> </tr> </table>	R50TT	R62TT	R72TT		R72TT1.3	R85TT1.0
R50TT	R62TT	R72TT						
	R72TT1.3	R85TT1.0						
581.023.00 (Alutec)		Boccola per foratura con impugnatura <i>Drilling bushing with handgrip</i>						
		<table border="1"> <tr> <td>R50TT</td> <td>R62TT</td> <td>R72TT</td> </tr> <tr> <td></td> <td>R72TT1.3</td> <td>R85TT1.0</td> </tr> </table>	R50TT	R62TT	R72TT		R72TT1.3	R85TT1.0
R50TT	R62TT	R72TT						
	R72TT1.3	R85TT1.0						
581.024.00 (Alutec)		Maschera piazzamento slitta rientro anta <i>Leaf retracting slide positioning template</i>						
		<table border="1"> <tr> <td>R50TT</td> <td>R62TT</td> <td>R72TT</td> </tr> <tr> <td></td> <td>R72TT1.3</td> <td>R85TT1.0</td> </tr> </table>	R50TT	R62TT	R72TT		R72TT1.3	R85TT1.0
R50TT	R62TT	R72TT						
	R72TT1.3	R85TT1.0						
581.025.00 (Alutec)		Morsetto di piazzamento guide scorrevoli <i>Sliding guides positioning clamp</i>						
		<table border="1"> <tr> <td>R50TT</td> <td>R62TT</td> <td>R72TT</td> </tr> <tr> <td></td> <td>R72TT1.3</td> <td>R85TT1.0</td> </tr> </table>	R50TT	R62TT	R72TT		R72TT1.3	R85TT1.0
R50TT	R62TT	R72TT						
	R72TT1.3	R85TT1.0						
581.026.00 (Alutec)		Maschera di foratura piazzamento carrelli <i>Rollers positioning drilling template</i>						
		<table border="1"> <tr> <td>R50TT</td> <td>R62TT</td> <td>R72TT</td> </tr> <tr> <td></td> <td>R72TT1.3</td> <td>R85TT1.0</td> </tr> </table>	R50TT	R62TT	R72TT		R72TT1.3	R85TT1.0
R50TT	R62TT	R72TT						
	R72TT1.3	R85TT1.0						
581.030.00 (Alutec)		Dima foratura per cerniere pesanti per montante ridotto interasse 60 mm <i>Drilling template for heavy hinges for small stile distance between centers mm 60</i>						
		<table border="1"> <tr> <td>R50TT</td> <td>R62TT</td> <td>R72TT</td> </tr> <tr> <td></td> <td>R72TT1.3</td> <td>R85TT1.0</td> </tr> </table>	R50TT	R62TT	R72TT		R72TT1.3	R85TT1.0
R50TT	R62TT	R72TT						
	R72TT1.3	R85TT1.0						
581.033.00 (Alutec)		Dima universale per tavellino. <i>Universal template for flat catch.</i>						
		<table border="1"> <tr> <td>R50TT</td> <td>R62TT</td> <td>R72TT</td> </tr> <tr> <td></td> <td>R72TT1.3</td> <td>R85TT1.0</td> </tr> </table>	R50TT	R62TT	R72TT		R72TT1.3	R85TT1.0
R50TT	R62TT	R72TT						
	R72TT1.3	R85TT1.0						

Articolo Item	Immagine Picture	Descrizione Description						
581.034.00 (Alutec)		Punzonatrice lavorazione astine <i>Punching machine for rods processing</i>						
		<table border="1"> <tr> <td>R50TT</td> <td>R62TT</td> <td>R72TT</td> </tr> <tr> <td></td> <td>R72TT1.3</td> <td>R85TT1.0</td> </tr> </table>	R50TT	R62TT	R72TT		R72TT1.3	R85TT1.0
R50TT	R62TT	R72TT						
	R72TT1.3	R85TT1.0						
581.041.00 (Alutec)		Dima foratura per cerniere ad elevata portata <i>Drilling template for heavy hinges</i>						
		<table border="1"> <tr> <td>R50TT</td> <td>R62TT</td> <td>R72TT</td> </tr> <tr> <td></td> <td>R72TT1.3</td> <td>R85TT1.0</td> </tr> </table>	R50TT	R62TT	R72TT		R72TT1.3	R85TT1.0
R50TT	R62TT	R72TT						
	R72TT1.3	R85TT1.0						
581.171.00 (Alutec)		Cesoia taglia guarnizioni in metallo UNIV. <i>Metal shear for weatherstrips cutting</i>						
		<table border="1"> <tr> <td>R50TT</td> <td>R62TT</td> <td>R72TT</td> </tr> <tr> <td>R72TTCE</td> <td>R72TT1.3</td> <td>R85TT1.0</td> </tr> </table>	R50TT	R62TT	R72TT	R72TTCE	R72TT1.3	R85TT1.0
R50TT	R62TT	R72TT						
R72TTCE	R72TT1.3	R85TT1.0						
M.2001.00		Cianfrinatrice manuale <i>Manual crimping tool</i>						
		<table border="1"> <tr> <td>R50TT</td> <td>R62TT</td> <td>R72TT</td> </tr> <tr> <td>R72TTCE</td> <td>R72TT1.3</td> <td>R85TT1.0</td> </tr> </table>	R50TT	R62TT	R72TT	R72TTCE	R72TT1.3	R85TT1.0
R50TT	R62TT	R72TT						
R72TTCE	R72TT1.3	R85TT1.0						
U.9801.VV		Chiave esagonale doppia da 4-5-6 UNIV. <i>Double exagonal wrench of 4-5-6</i>						
		<table border="1"> <tr> <td>R50TT</td> <td>R62TT</td> <td>R72TT</td> </tr> <tr> <td>R72TTCE</td> <td>R72TT1.3</td> <td>R85TT1.0</td> </tr> </table>	R50TT	R62TT	R72TT	R72TTCE	R72TT1.3	R85TT1.0
R50TT	R62TT	R72TT						
R72TTCE	R72TT1.3	R85TT1.0						
U.9802.VV		Chiave esagonale doppia da 2.5-3 UNIV. <i>Double exagonal wrench of 2.5-3</i>						
		<table border="1"> <tr> <td>R50TT</td> <td>R62TT</td> <td>R72TT</td> </tr> <tr> <td>R72TTCE</td> <td>R72TT1.3</td> <td>R85TT1.0</td> </tr> </table>	R50TT	R62TT	R72TT	R72TTCE	R72TT1.3	R85TT1.0
R50TT	R62TT	R72TT						
R72TTCE	R72TT1.3	R85TT1.0						

GUARNIZIONI
WEATHERSTRIPS

GUARNIZIONI
WEATHERSTRIPS

Articolo Item	Immagine Picture	Descrizione Description						
G.0119.EN		Guarnizione di battuta per bilico <i>Pivoting weatherstrip of rabbet</i> E.P.D.M. <table border="1"> <tr> <td>R50TT</td> <td>R62TT</td> <td></td> </tr> <tr> <td></td> <td>R72TT1.3</td> <td></td> </tr> </table>	R50TT	R62TT			R72TT1.3	
R50TT	R62TT							
	R72TT1.3							

Articolo Item	Immagine Picture	Descrizione Description						
G.0130.EN		Guarnizione per coprigiunto - 5mm <i>Coverjoint weatherstrip - 5mm</i> E.P.D.M. <table border="1"> <tr> <td>R50TT</td> <td>R62TT</td> <td></td> </tr> <tr> <td></td> <td></td> <td></td> </tr> </table>	R50TT	R62TT				
R50TT	R62TT							

G.0120.EN ^(ABP)		Guarnizione di precamera. <i>Central weatherstrip.</i> <table border="1"> <tr> <td></td> <td>R62TT</td> <td></td> </tr> <tr> <td></td> <td></td> <td></td> </tr> </table>		R62TT				
	R62TT							

G.0131.EN ^(ABP)		Guarnizione di battuta ad inserimento a scatto <i>Released insertion weatherstrip on rabbet</i> E.P.D.M. <table border="1"> <tr> <td>R50TT</td> <td>R62TT</td> <td>R72TT</td> </tr> <tr> <td></td> <td>R72TT1.3</td> <td>R85TT1.0</td> </tr> </table>	R50TT	R62TT	R72TT		R72TT1.3	R85TT1.0
R50TT	R62TT	R72TT						
	R72TT1.3	R85TT1.0						

G.0123.EN		Guarnizione da 4-6 mm su f.vetro <i>mm 4-6 glass support weatherstrip</i> <table border="1"> <tr> <td>R50TT</td> <td>R62TT</td> <td>R72TT</td> </tr> <tr> <td>R72TTCE</td> <td>R72TT1.3</td> <td>R85TT1.0</td> </tr> </table>	R50TT	R62TT	R72TT	R72TTCE	R72TT1.3	R85TT1.0
R50TT	R62TT	R72TT						
R72TTCE	R72TT1.3	R85TT1.0						

G.0133.EN		Guarnizione copri giunto. <i>Edge trim gasket for thermal break profiles.</i> <table border="1"> <tr> <td></td> <td>R62TT</td> <td></td> </tr> <tr> <td></td> <td></td> <td>R85TT1.0</td> </tr> </table>		R62TT				R85TT1.0
	R62TT							
		R85TT1.0						

G.0124.EN		Guarnizione da 2,5-3,5 mm su f.vetro <i>mm 2,5-3,5 glass support weatherstrip</i> <table border="1"> <tr> <td>R50TT</td> <td>R62TT</td> <td>R72TT</td> </tr> <tr> <td>R72TTCE</td> <td>R72TT1.3</td> <td>R85TT1.0</td> </tr> </table>	R50TT	R62TT	R72TT	R72TTCE	R72TT1.3	R85TT1.0
R50TT	R62TT	R72TT						
R72TTCE	R72TT1.3	R85TT1.0						

G.0134.EN ^(ABP)		Guarnizione esterna vetro <i>External weatherstrips on glass</i> E.P.D.M. <table border="1"> <tr> <td>R50TT</td> <td>R62TT</td> <td>R72TT</td> </tr> <tr> <td>R72TTCE</td> <td>R72TT1.3</td> <td>R85TT1.0</td> </tr> </table>	R50TT	R62TT	R72TT	R72TTCE	R72TT1.3	R85TT1.0
R50TT	R62TT	R72TT						
R72TTCE	R72TT1.3	R85TT1.0						

G.0126.EN ^(ABP)		Guarnizione di battuta <i>Weatherstrip of rabbet</i>						
G.0138.RN ^(ABP)		EN = E.P.D.M.						
G.0155.TN ^(BP)		RN = PVC coestruso <i>Coextruded P.V.C.</i>						
G.0156.FN ^(BP)		TN = Termoplastica <i>T.P.R.</i> FN = E.P.D.M. coestruso <i>Coextruded E.P.D.M.</i>						
		<table border="1"> <tr> <td>R50TT</td> <td>R62TT</td> <td>R72TT</td> </tr> <tr> <td></td> <td>R72TT1.3</td> <td>R85TT1.0</td> </tr> </table>	R50TT	R62TT	R72TT		R72TT1.3	R85TT1.0
R50TT	R62TT	R72TT						
	R72TT1.3	R85TT1.0						

G.0139.RN ^(ABP)		Guarnizione appoggio vetri 1.5 mm <i>Weatherstrip on glass support mm 1,5</i> <table border="1"> <tr> <td>R50TT</td> <td>R62TT</td> <td>R72TT</td> </tr> <tr> <td>R72TTCE</td> <td>R72TT1.3</td> <td>R85TT1.0</td> </tr> </table>	R50TT	R62TT	R72TT	R72TTCE	R72TT1.3	R85TT1.0
R50TT	R62TT	R72TT						
R72TTCE	R72TT1.3	R85TT1.0						

G.0140.RN ^(ABP)		Guarnizione appoggio vetri da 3 mm <i>mm 3 glass support weatherstrip</i> <table border="1"> <tr> <td>R50TT</td> <td>R62TT</td> <td>R72TT</td> </tr> <tr> <td>R72TTCE</td> <td>R72TT1.3</td> <td>R85TT1.0</td> </tr> </table>	R50TT	R62TT	R72TT	R72TTCE	R72TT1.3	R85TT1.0
R50TT	R62TT	R72TT						
R72TTCE	R72TT1.3	R85TT1.0						

G.0127.EN ^(ABP)		Guarnizione su fermavetro spessore 2 mm <i>Weatherstrip on glazing bead shim 2 mm</i> E.P.D.M. <table border="1"> <tr> <td>R50TT</td> <td>R62TT</td> <td>R72TT</td> </tr> <tr> <td>R72TTCE</td> <td>R72TT1.3</td> <td>R85TT1.0</td> </tr> </table>	R50TT	R62TT	R72TT	R72TTCE	R72TT1.3	R85TT1.0
R50TT	R62TT	R72TT						
R72TTCE	R72TT1.3	R85TT1.0						

G.0149.EN ^(BP)		Guarnizione su fermavetro spessore 4 mm <i>Weatherstrip on glazing bead shim 4 mm</i> E.P.D.M. <table border="1"> <tr> <td>R50TT</td> <td>R62TT</td> <td>R72TT</td> </tr> <tr> <td>R72TTCE</td> <td>R72TT1.3</td> <td>R85TT1.0</td> </tr> </table>	R50TT	R62TT	R72TT	R72TTCE	R72TT1.3	R85TT1.0
R50TT	R62TT	R72TT						
R72TTCE	R72TT1.3	R85TT1.0						

G.0128.EN ^(ABP)		Guarnizione su fermavetro spessore 3 mm <i>Weatherstrip on glazing bead shim 3 mm</i> E.P.D.M. <table border="1"> <tr> <td>R50TT</td> <td>R62TT</td> <td>R72TT</td> </tr> <tr> <td>R72TTCE</td> <td>R72TT1.3</td> <td>R85TT1.0</td> </tr> </table>	R50TT	R62TT	R72TT	R72TTCE	R72TT1.3	R85TT1.0
R50TT	R62TT	R72TT						
R72TTCE	R72TT1.3	R85TT1.0						

G.0150.EN ^(BP)		Guarnizione su fermavetro spessore 5 mm <i>Weatherstrip on glazing bead shim 5 mm</i> E.P.D.M. <table border="1"> <tr> <td>R50TT</td> <td>R62TT</td> <td>R72TT</td> </tr> <tr> <td>R72TTCE</td> <td>R72TT1.3</td> <td>R85TT1.0</td> </tr> </table>	R50TT	R62TT	R72TT	R72TTCE	R72TT1.3	R85TT1.0
R50TT	R62TT	R72TT						
R72TTCE	R72TT1.3	R85TT1.0						

G.0129.EN ^(ABP)		Guarnizione su fermavetro spessore 6 mm <i>Weatherstrip on glazing bead shim 6 mm</i> E.P.D.M. <table border="1"> <tr> <td>R50TT</td> <td>R62TT</td> <td>R72TT</td> </tr> <tr> <td>R72TTCE</td> <td>R72TT1.3</td> <td>R85TT1.0</td> </tr> </table>	R50TT	R62TT	R72TT	R72TTCE	R72TT1.3	R85TT1.0
R50TT	R62TT	R72TT						
R72TTCE	R72TT1.3	R85TT1.0						

G.0152.EN		Guarnizione appoggio esterno vetri da 3 mm <i>mm 3 glass support weatherstrip</i> <table border="1"> <tr> <td>R50TT</td> <td>R62TT</td> <td>R72TT</td> </tr> <tr> <td>R72TTCE</td> <td>R72TT1.3</td> <td>R85TT1.0</td> </tr> </table>	R50TT	R62TT	R72TT	R72TTCE	R72TT1.3	R85TT1.0
R50TT	R62TT	R72TT						
R72TTCE	R72TT1.3	R85TT1.0						

GUARNIZIONI
WEATHERSTRIPS

GUARNIZIONI
WEATHERSTRIPS

Articolo Item	Immagine Picture	Descrizione Description
------------------	---------------------	----------------------------

Articolo Item	Immagine Picture	Descrizione Description
------------------	---------------------	----------------------------

G.0168.EN

Guarnizione isolamento termico
telaio-muro
Weatherstrip thermal insulation
frame-wall



R50TT	R62TT	R72TT
R72TTCE	R72TT1.3	R85TT1.0

G.0314.RN^(AP)



Guarnizione di tenuta su profili
800780
Sealing weatherstrip on profile
800780

R50TT	R62TT	R72TT
R72TTCE	R72TT1.3	R85TT1.0

G.0316.QN



Guarnizione porta spazzolino
Weatherstrip woolpile holder

R50TT	R62TT	R72TT
	R72TT1.3	R85TT1.0

G.0317.RN



Guarnizione per collegamento
profili
Profile connection gasket
P.V.C. coestruso
Coextruded P.V.C.

R50TT	R62TT	R72TT
	R72TT1.3	R85TT1.0

ANGOLI STAMPATI IN EPDM
EPDM MOULDED CORNERS

Articolo Item	Immagine Picture	Descrizione Description
------------------	---------------------	----------------------------

A.0225.EN

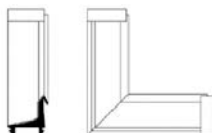

Angolo stampato per guarnizione
G.0120.EN.
Moulded corner for weatherstrip
G.0120.EN.

A.0225.TN^(AP)

EN = E.P.D.M.
TN = Termoplastica/T.P.R.

	R62TT	
--	-------	--

DIAGRAMMI PER IL DIMENSIONAMENTO STATICO DELLE ANTE STATIC WING-SIZING DIAGRAMS

I grafici di seguito riportati sono stati ottenuti con la seguente formula:
The graphs below were created using the following formula:

$$J(\text{cm}^4) = \frac{q(\text{Kg}/\text{cm}^2) \times H^4 (\text{cm}) \times A(\text{cm})}{1920 \times E(\text{Kg}/\text{cm}^2) \times f(\text{cm})} \times \left[25 \cdot 40 \times \left(\frac{A}{H} \right)^2 + 16 \times \left(\frac{A}{H} \right)^4 \right]$$

Dove:

Jx = Momento d'inerzia (cm⁴) A = Larghezza anta : 2 (cm)
q = Carico del vento (Kg/cm²) E = Modulo di elasticità (Kg/cm²)
H = Altezza anta (cm) f = Freccia (cm)

Essa è riferita al dimensionamento delle ante rispetto all'inerzia del profilato, per cui verificare sempre che il peso delle ante sia compatibile con la portata degli accessori impiegati, cerniere ecc. Inoltre verificare, sempre che la freccia dei profilati sia compatibile con il vetro impiegato.

Were:

Jx = Moment of inertia (cm⁴) A = Wing/2 width (cm)
q = Wind load (Kg/cm²) E = Coefficient of elasticity (Kg/cm²)
H = Wing height (cm) f = Camber (cm)

This refers to the size of the wings compared with the section inertia so always make sure the weight of the wings is compatible with the load of accessories hinge etc. used. Also always check that the section camber is suitable for the glass used.

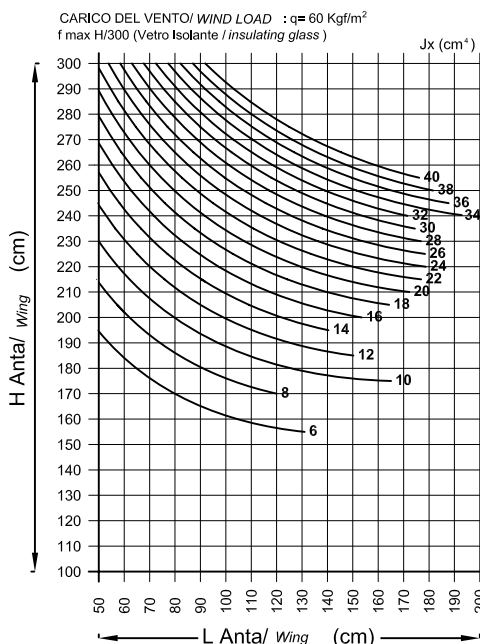
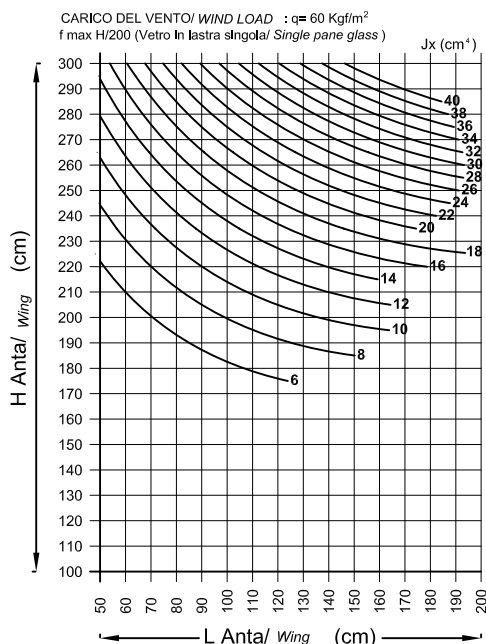
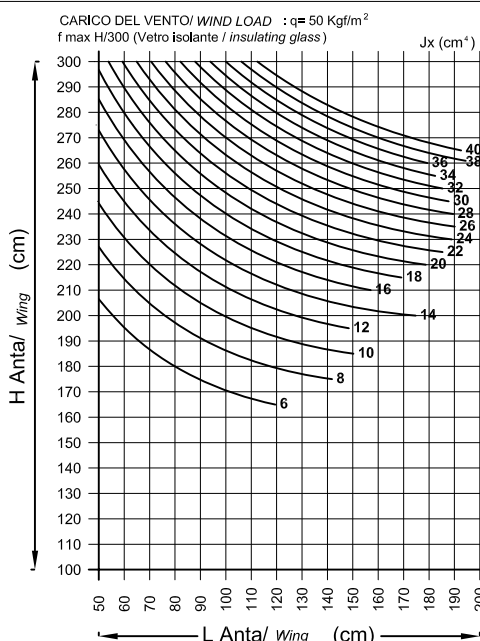
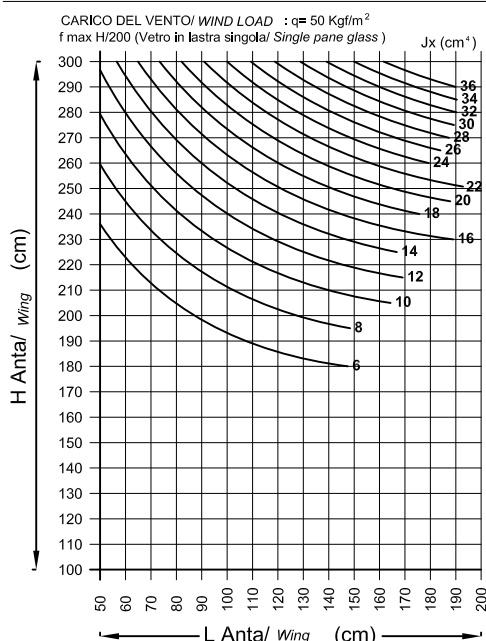
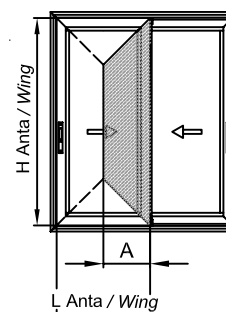
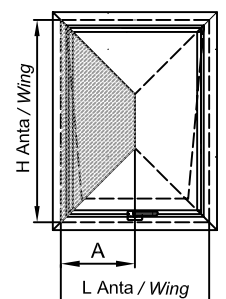
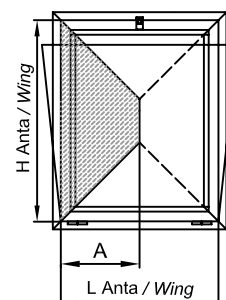
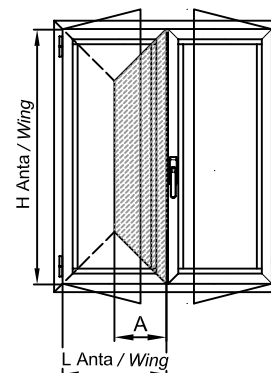
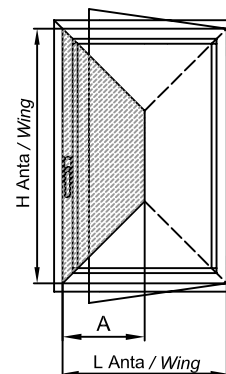

DIAGRAMMI PER IL DIMENSIONAMENTO STATICO DELLE ANTE

STATIC WING-SIZING DIAGRAMS

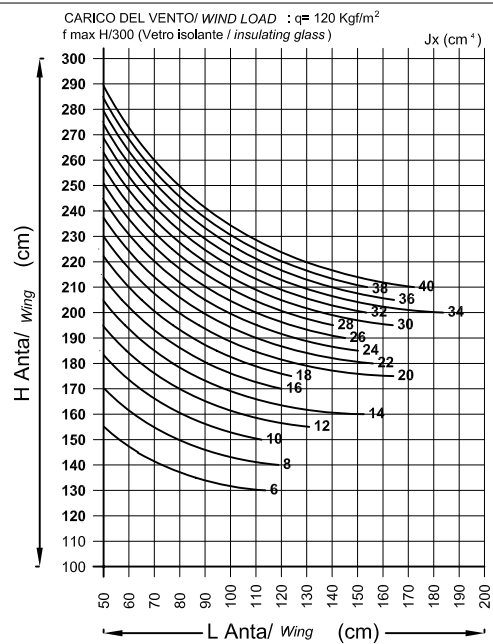
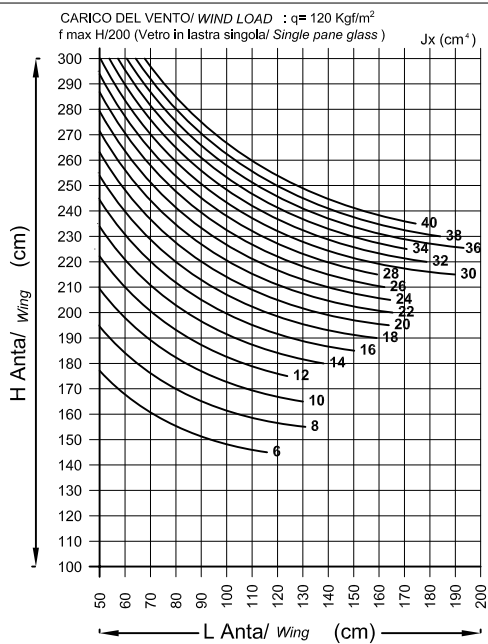
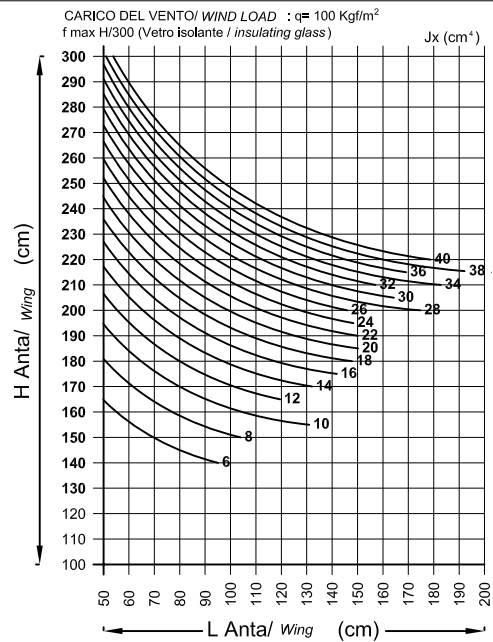
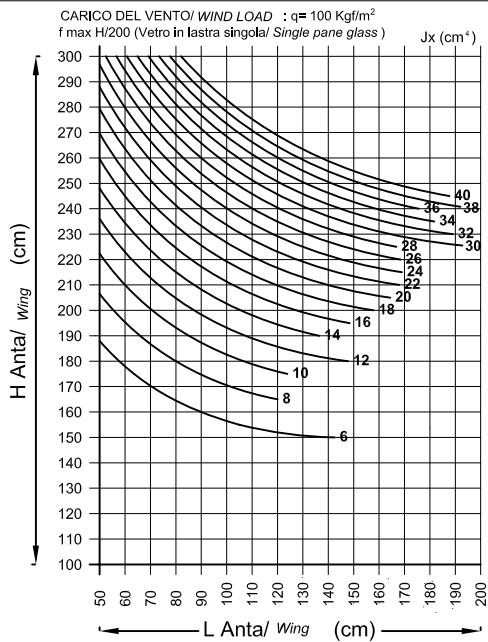
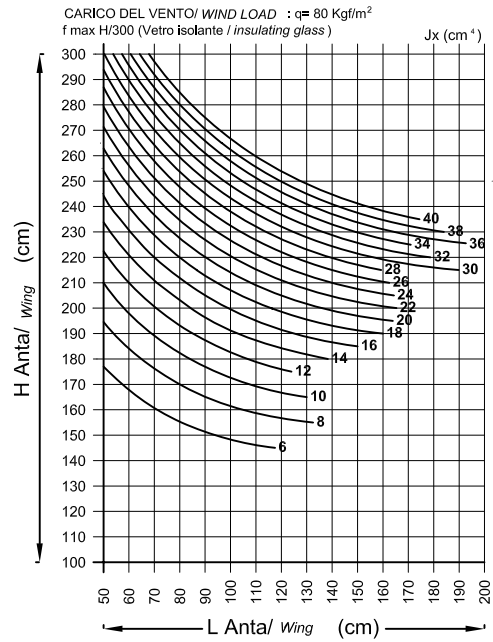
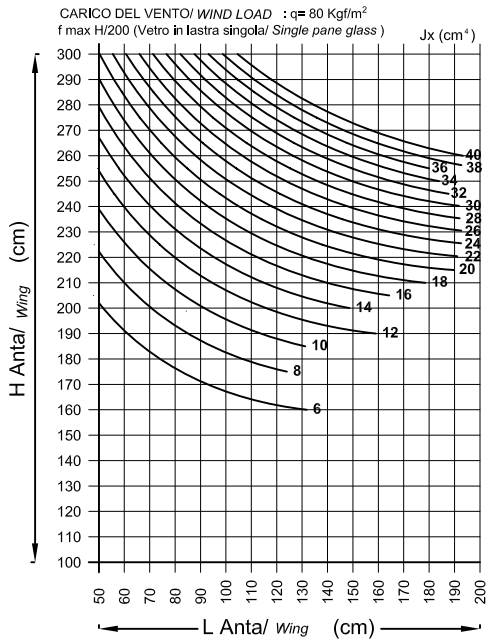

INSERIMENTO GUARNIZIONI, VETRI E FERMAVETRI WEATHERSTRIPS. GLASS AND GLASS BEADINGS INSERTION

R 62^{TT}
SYSTEM

Articolo <i>Item</i>	Guarnizioni esterne <i>External weatherstrips</i>	Sezione <i>Section</i>	Articolo <i>Item</i>	Guarnizioni interne <i>Internal weatherstrips</i>	Sezione <i>Section</i>
G.0139.RN	A = 1,5 mm		G.0127.EN	D = 2 mm	
G.0134.EN	B = 3 mm		G.0128.EN	E = 3 mm	
G.0140.RN	C = 3 mm		G.0129.EN	F = 5/6 mm	

Spessore vetri <i>Glass thickness</i>	Guarnizioni <i>Weatherstrips</i>	Dimensione fermavetri <i>Glass beading size</i>	Vetro ad infilare <i>Glass to insert</i>				
5/6 7/8 8 9 9 10	B/C + F A + F B/C + E B/C + D A + E A + D	35 mm					
10/11 11/12 11 14 14 15	B/C + F A + F B/C + E B/C + D A + F A + D	30 mm					
12/13 13/14 13 16 16 17	B/C + F A + F B/C + E B/C + D A + F A + D	28 mm					
14/15 15/16 17 18 18 19	B/C + F A + F B/C + E B/C + D A + E A + D	26 mm					
17/18 19/20 20 21 22 23	B/C + F A + F B/C + E B/C + D A + E A + D	22,5 mm					
18/19 19/20 21 22 22 23	B/C + F A + F B/C + E B/C + D A + E A + D	22 mm					
21/22 22/23 24 25 25 26	B/C + F A + F B/C + E B/C + D A + E A + D	19 mm					
22/23 23/24 25 26 26 27	B/C + F A + F B/C + E B/C + D A + E A + D	18 mm					
23/24 24/25 26 27 27 28	B/C + F A + F B/C + E B/C + D A + E A + D	17 mm					
26/27 27/28 29 30 30 31	B/C + F A + F B/C + E B/C + D A + E A + D	14 mm					
29/30 30/31 32 33 33 34	B/C + F A + F B/C + E B/C + D A + F A + D	11 mm					
30/31 31/32 33 34 34 35	B/C + F A + F B/C + E B/C + D A + E A + D	10 mm					
● 31/32 ● 32/33 ● 34 ● 35 ● 35 ● 36	B/C + F A + F B/C + E B/C + D A + E A + D	9 mm					
● 35/36 ● 36/37 ● 38 ● 39 ● 39 ● 40	B/C + F A + F B/C + E B/C + D A + E A + D	5 mm					
● 38/39 ● 39/40 ● 41 ● 42 ● 42 ● 43	B/C + F A + F B/C + E B/C + D A + E A + D	2 mm					
22/23 23/24 25 26 26 27/28	B/C + F A + F B/C + E B/C + D A + E A + D	X = 31 mm					

N.B.: Le combinazioni sopra indicate sono state ottenute considerando le quote teoriche. Si consiglia sempre di verificare le tolleranze per applicare vetri, fermavetri e guarnizioni ottimali.

● Spessore pannelli /

Panel thickness

The above combinations were obtained considering the theoretic heights. It is always best to check tolerances to apply correct glass, glass beadings and weatherstrips.

POSIZIONAMENTO ACCESSORIO FERMAVETRO ARROTONDATO
ROUNDED GLASSES BEADING ACCESSORY POSITIONING

Sezione Fermavetri Glass Beading Section		Dimensione Size
F	G	
		30 mm
900614	900617	
		30 mm
800681	800682	
		26 mm
800677	800678	
		22,5 mm
900607	600027	
		19 mm
800303	800339	
		18 mm
800679	800680	
		14 mm
800307	800313	
		14 mm
800661	800662	

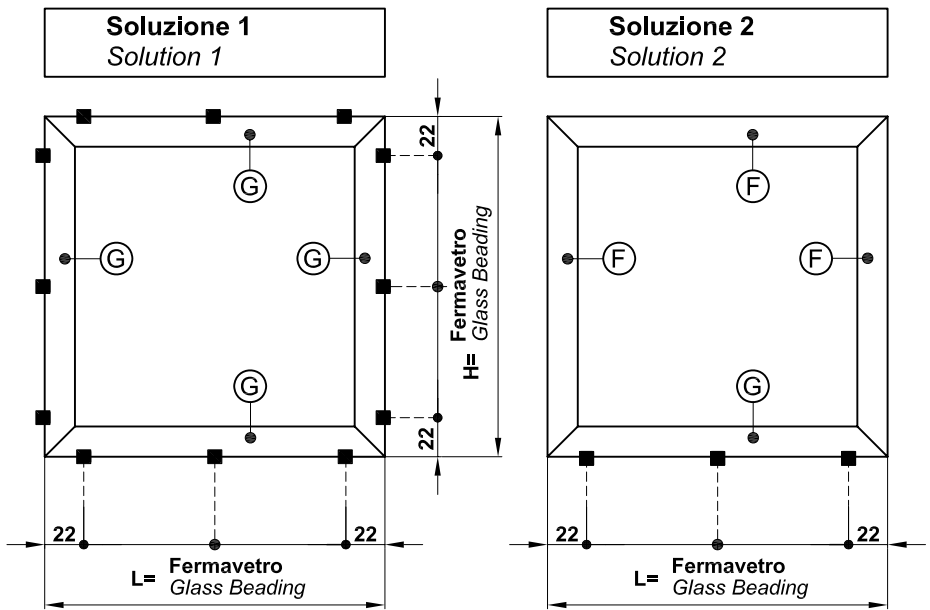



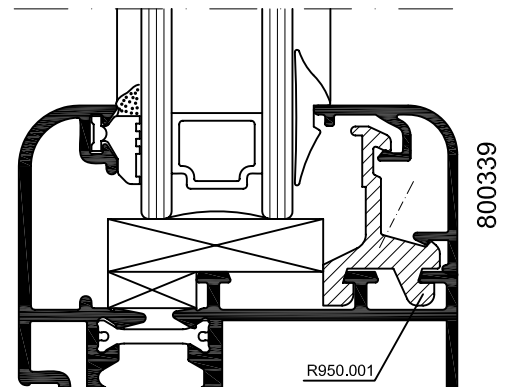
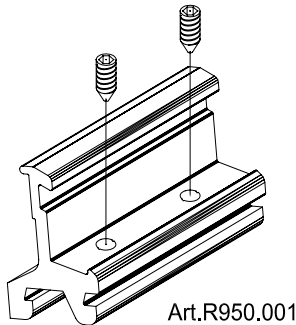



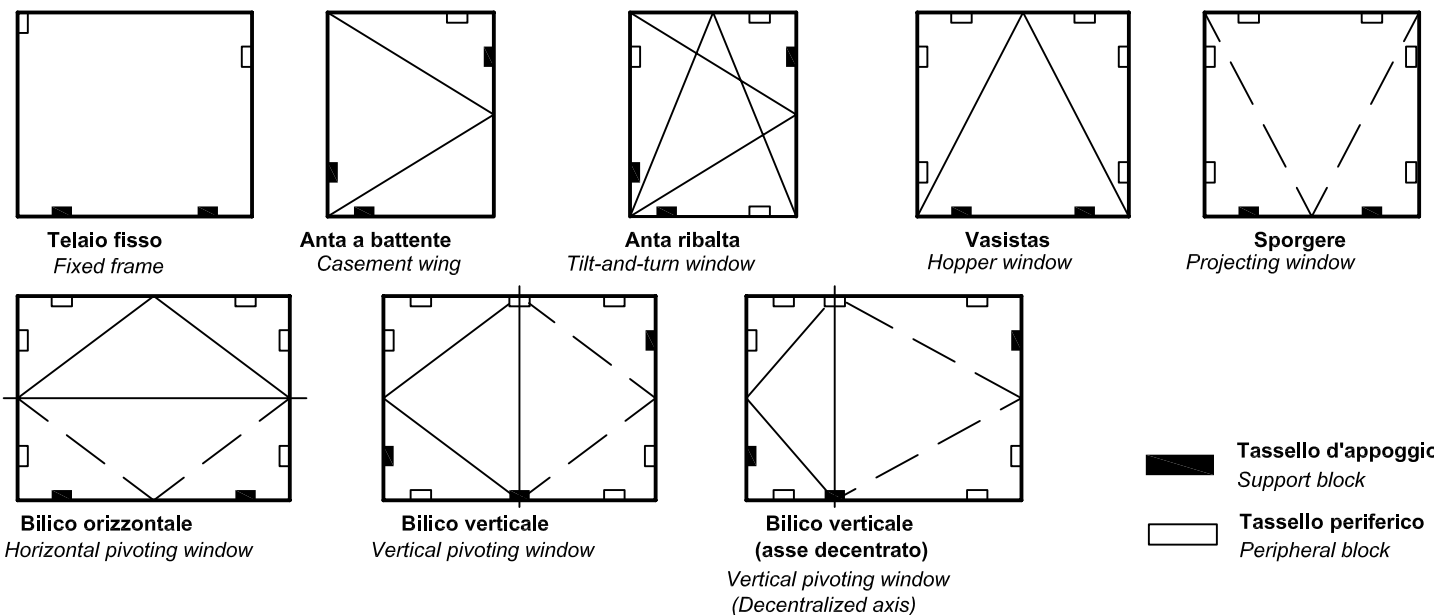









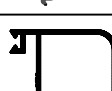
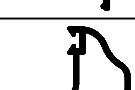
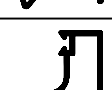

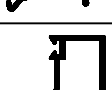





- F** = Fermavetro arr. a scatto
Radiused glass beading snap
- G** = Fermavetro arr. con accessorio R950.001
Radiused glass beading with accessorire R950.001
- = Art. R950.001
Per L/H ≤ 1000mm n°3pz
Per L/H < 1000mm ≤ 1500mm n°4pz
Per L/H > 1500mm n°5pz



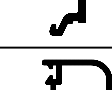
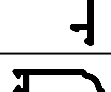

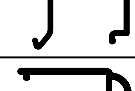
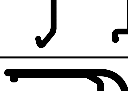
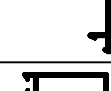
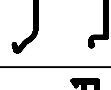
SPESSORAMENTO VETRI
GLASS SHIM



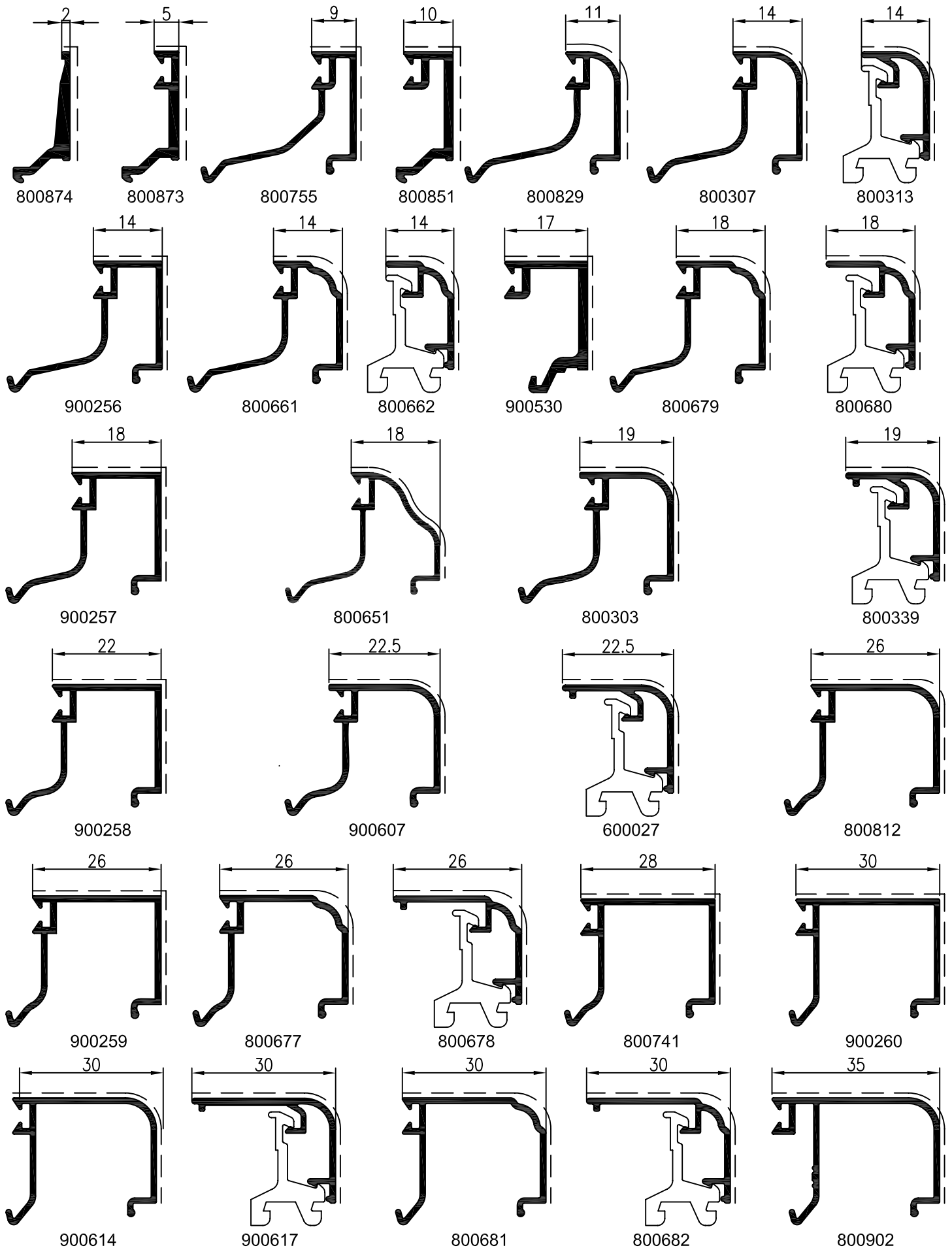

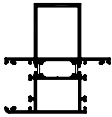
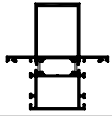
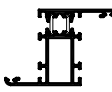
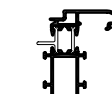
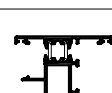
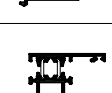
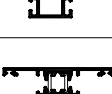
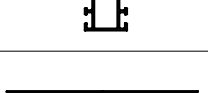
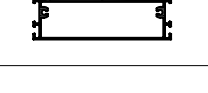
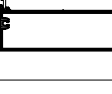

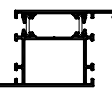
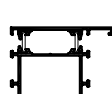



Profilato Section	Sezione Cross section	Peso Weight Kg/m	Perlm. Perim. mm	Sup. in vista Expose surface m /m ²	Profilato Section	Sezione Cross section	Peso Weight Kg/m	Perlm. Perim. mm	Sup. in vista Expose surface m /m ²
600027		0,181	115	0,042	800829		0,253	167	0,030
800303		0,271	173	0,041	800851		0,231	109	0,035
800307		0,256	169	0,040	800873		0,186	87	0,029
800313		0,145	93	0,040	800874		0,183	71	0,026
800339		0,170	108	0,044	800902		0,322	203	0,056
800651		0,251	161	0,033	900256		0,270	173	0,036
800661		0,259	167	0,032	900257		0,275	175	0,040
800662		0,140	90	0,031	900258		0,278	177	0,044
800677		0,273	173	0,044	900259		0,283	179	0,048
800678		0,184	117	0,044	900260		0,286	185	0,052
800679		0,265	169	0,036	900530		0,276	126	0,039
800680		0,154	99	0,036	900607		0,273	174	0,038
800681		0,281	178	0,048	900614		0,278	180	0,050
800682		0,197	125	0,048	900617		0,219	129	0,052
800741		0,289	183	0,050					
800755		0,262	167	0,032					
800812		0,275	174	0,040					

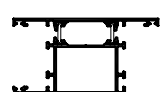
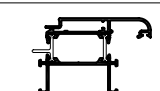

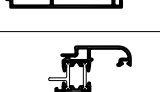
Profilato Section	Comp.ne Composition	Sezione Cross section 	Peso Weight Kg/m	Perimetro Perimeter mm	Superficie in vista Exposed surface m ² /m	Jx cm ⁴	Wx cm ³	Jy cm ⁴	Wy cm ³
R62C02 R62D02	800617 A.0320.LN A.0320.LN 800591		2,418	620	0,283	91,95	16,72	41,99	8,42
R62C03 R62D03	800617 A.0320.LN A.0320.LN 800592		2,305	558	0,258	82,16	15,63	36,07	7,52
R62C05 R62D05	800504 A.0320.LN A.0320.LN 800585		1,254	408	0,109	17,23	6,08	8,83	2,44
R62C06 R62D06	800507 A.0320.LN A.0319.LN 800585		1,389	459	0,114	22,56	7,09	10,52	2,79
R62C07 R62D07	800587 A.0320.LN A.0320.LN 800586		1,277	413	0,107	17,07	4,88	8,20	2,31
R62C08 R62D08	800504 A.0320.LN A.0320.LN 800588		1,142	346	0,083	13,99	4,48	5,42	1,64
R62C09 R62D09	800508 A.0320.LN A.0320.LN 800588		1,258	410	0,110	15,76	4,72	9,05	2,51
R62C10 R62D10	800511 A.0320.LN A.0320.LN 800589		2,549	582	0,282	36,24	11,68	174,59	22,10
R62C11 R62D11	800511 A.0320.LN A.0320.LN 800590		2,667	646	0,309	39,86	13,41	194,88	23,75
R62C12 R62D12	800508 A.0320.LN A.0320.LN 800585		1,370	472	0,136	19,60	6,40	1,82	3,08
R62C13 R62D13	800514 A.0320.LN A.0320.LN 800591		1,554	456	0,156	22,54	7,82	27,14	5,63
R62C14 R62D14	800514 A.0320.LN A.0320.LN 800592		1,441	394	0,131	19,20	6,17	20,34	4,56
R62C15 R62D15	800516 A.0320.LN A.0320.LN 800592		1,561	458	0,158	21,03	6,40	27,60	5,75

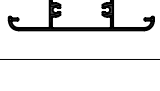
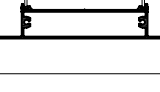
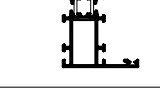
Le lettere C e D presenti nei codici sopra riportati stanno ad indicare rispettivamente:
C = profili interno ed esterno più barrette assemblati - es. R62C41
D = profili interno ed esterno più barrette non assemblati - es. R62D41
N.B.: I profilati sono forniti in lunghezza di 6800 mm

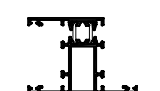
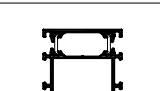
The letters C and D in the above codes indicate respectively:
C = Assembled internal and external sections with bars - ex. R62C41
D = Non assembled internal and external sections with bars - ex. R62D41
The sections are supplied with length of 6800 mm

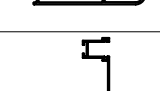
Profilato Section	Comp.ne Composition	Sezione Cross section 	Peso Weight Kg/m	Perimetro Perimeter mm	Superficie in vista Exposed surface m ² /m	Jx cm ⁴	Wx cm ³	Jy cm ⁴	Wy cm ³
R62C16 R62D16	800516 A.0320.LN A.0320.LN 800591		1,674	520	0,183	24,79	8,10	33,38	6,58
R62C17 R62D17	800517 A.0320.LN A.0319.LN 800591		1,790	507	0,161	30,73	9,22	31,24	6,24
R62C18 R62D18	800514 A.0320.LN A.0320.LN 800593		1,760	410	0,153	23,47	8,55	36,90	7,40
R62C19 R50D19	800507 A.0320.LN A.0319.LN 800596		1,490	504	0,150	22,56	7,09	10,52	2,79
R62C20 R62D20	800516 A.0320.LN A.0320.LN 800594		1,817	495	0,214	19,22	8,54	41,61	8,67
R62C21 R62D21	800511 A.0320.LN A.0320.LN 800595		2,676	619	0,338	28,74	12,52	199,20	25,21
R62C23 R62D23	800538 A.0320.LN A.0320.LN 800608		1,141	346	0,083	14,50	5,08	5,41	1,64
R62C24 R62D24	800538 A.0320.LN A.0320.LN 800597		1,258	410	0,110	14,61	5,24	9,05	2,51
R62C25 R62D25	800504 A.0320.LN A.0320.LN 800597		1,376	474	0,137	20,27	7,19	12,01	3,12
R62C26 R62D26	800540 A.0320.LN A.0320.LN 800598		1,558	458	0,158	22,52	7,65	27,54	5,74
R62C27 R62D27	800514 A.0320.LN A.0320.LN 800599		1,514	381	0,159	15,13	6,56	24,30	5,97
R62C28 R62D28	800547 A.0320.LN A.0320.LN 800585		1,999	726	0,126	140,76	17,97	22,42	4,87
R62C29 R62D29	800548 A.0320.LN A.0320.LN 800585		1,852	657	0,094	71,01	12,28	18,70	4,25

Le lettere C e D presenti nei codici sopra riportati stanno ad indicare rispettivamente:
C = profili interno ed esterno più barrette assemblati - es. R62C41
D = profili interno ed esterno più barrette non assemblati - es. R62D41
N.B.: I profilati sono forniti in lunghezza di 6800 mm

The letters C and D in the above codes indicate respectively:
C = Assembled internal and external sections with bars - ex. R62C41
D = Non assembled internal and external sections with bars - ex. R62D41
The sections are supplied with length of 6800 mm

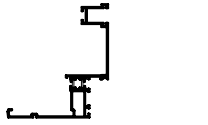
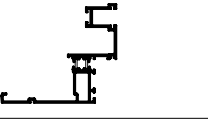
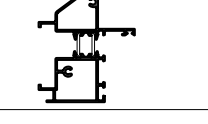
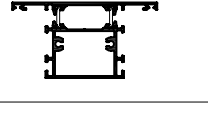
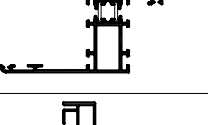
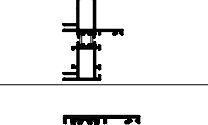
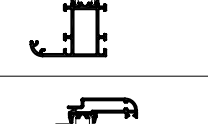
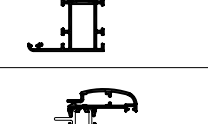
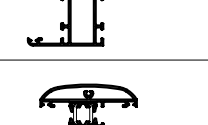
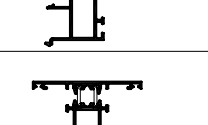
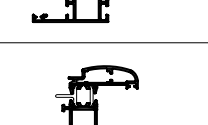
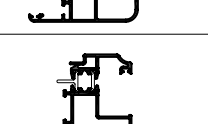
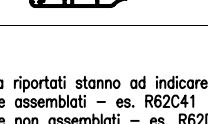
Profilato Section	Comp.ne Composition	Sezione Cross section	Peso Weight Kg/m	Perimetro Perimeter mm	Superficie in vista Exposed surface m ² /m	Jx cm ⁴	Wx cm ³	Jy cm ⁴	Wy cm ³
R62C30 R62D30	800547 A.0320.LN A.0320.LN 800705		2,181	802	0,166	164,70	19,62	68,70	8,08
R62C31 R62D31	800548 A.0320.LN A.0320.LN 800705		2,034	738	0,134	86,56	13,79	62,24	7,54
R62C32 R62D32	800804 A.0320.LN A.0320.LN 800601		1,715	457	0,102	34,41	8,20	14,63	3,70
R62C33 R62D33	800516 A.0320.LN A.0320.LN 800603		1,719	458	0,158	21,65	6,81	29,38	6,12
R62C34 R62D34	800504 A.0320.LN A.0320.LN 800604		1,445	500	0,143	21,73	7,38	28,08	4,44
R62C35 R62D35	800575 A.0320.LN A.0320.LN 800605		2,134	623	0,162	104,84	17,99	11,18	2,98
R62C36 R62D36	800504 A.0320.LN A.0320.LN 800607		1,286	417	0,114	17,78	6,39	9,99	2,72
R62C37 R62D37	800618 A.0320.LN A.0319.LN 800585		1,407	422	0,114	22,41	7,03	11,05	2,88
R62C39 R62D39	800621 A.0320.LN A.0319.LN 800585		1,461	426	0,116	24,02	7,28	11,37	2,93
R62C40 R62D40	800622 A.0320.LN A.0320.LN 800586		1,605	425	0,114	25,32	6,12	12,05	3,47
R62C41 R62D41	800508 A.0320.LN A.0320.LN 800608		1,375	479	0,137	19,76	6,49	12,03	3,13
R62C43 R62D43	800621 A.0320.LN A.0319.LN 800596		1,562	465	0,152	27,68	8,26	15,41	3,71
R62C44 R62D44	800628 A.0320.LN A.0319.LN 800627		1,424	435	0,138	22,87	7,02	11,60	2,97





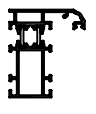
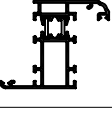
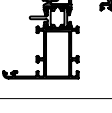
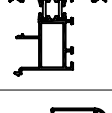
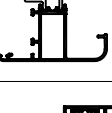
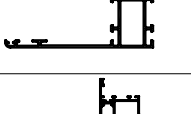
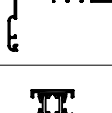
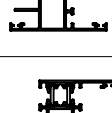
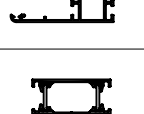
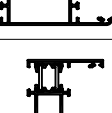
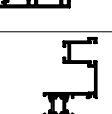
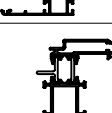
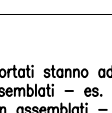

Le lettere C e D presenti nei codici sopra riportati stanno ad indicare rispettivamente:
C = profili interno ed esterno più barrette assemblati - es. R62C41
D = profili interno ed esterno più barrette non assemblati - es. R62D41
N.B.: I profilati sono forniti in lunghezza di 6800 mm

The letters C and D in the above codes indicate respectively:
C = Assembled internal and external sections with bars - ex. R62C41
D = Non assembled internal and external sections with bars - ex. R62D41
The sections are supplied with length of 6800 mm

Profilato Section	Comp.ne Composition	Sezione Cross section 	Peso Weight Kg/m	Perimetro Perimeter mm	Superficie in vista Exposed surface m ² /m	Jx cm ⁴	Wx cm ³	Jy cm ⁴	Wy cm ³
R62C45 R62D45	800648 A.0320.LN A.0320.LN 800588		1,357	403	0,088	20,07	5,51	7,48	2,33
R62C46 R62D46	800648 A.0320.LN A.0320.LN 800585		1,469	465	0,114	24,69	7,36	11,10	2,96
R62C47 R62D47	800649 A.0320.LN A.0319.LN 800585		1,397	455	0,115	22,72	7,13	10,48	2,77
R62C48 R62D48	800650 A.0320.LN A.0320.LN 800586		1,618	423	0,117	25,47	6,14	12,48	3,60
R62C49 R62D49	800618 A.0320.LN A.0319.LN 800596		1,508	466	0,150	25,76	7,89	15,18	3,69
R62C50 R62D50	800504 A.0320.LN A.0320.LN 800659		1,500	526	0,156	22,86	7,52	40,56	5,56
R62C51 R62D51	800690 A.0320.LN A.0320.LN 800689		2,725	987	0,267	77,94	10,27	174,01	20,36
R62C52 R62D52	800538 A.0320.LN A.0320.LN 800613		1,289	425	0,102	16,13	5,35	8,54	2,36
R62C53 R62D53	800504 A.0320.LN A.0320.LN 800701		1,340	448	0,127	19,26	7,04	15,43	3,02
R62C54 R62D54	800540 A.0320.LN A.0320.LN 800591		1,437	392	0,129	22,52	7,65	27,54	5,74
R62C55 R62D55	800504 A.0320.LN A.0320.LN 800608		1,259	410	0,110	17,23	6,08	8,83	2,44
R62C56 R62D56	800548 A.0320.LN A.0320.LN 800701		1,938	696	0,112	71,01	12,28	18,70	4,25
R62C57 R62D57	800585 A.0320.LN A.0319.LN 800722		1,405	422	0,115	22,28	7,01	10,96	2,86

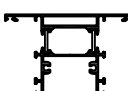
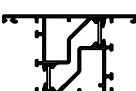
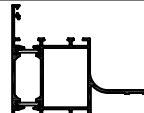
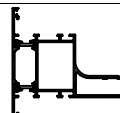
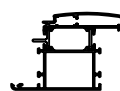

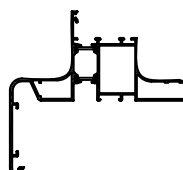
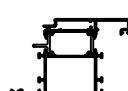
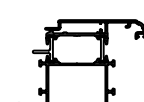
Le lettere C e D presenti nei codici sopra riportati stanno ad indicare rispettivamente:
C = profili interno ed esterno più barrette assemblati - es. R62C41
D = profili interno ed esterno più barrette non assemblati - es. R62D41
N.B.: I profilati sono forniti in lunghezza di 6800 mm

The letters C and D in the above codes indicate respectively:
C = Assembled internal and external sections with bars - ex. R62C41
D = Non assembled internal and external sections with bars - ex. R62D41
The sections are supplied with length of 6800 mm

Profilato Section	Comp.ne Composition	Sezione Cross section	Peso Weight Kg/m	Perimetro Perimeter mm	Superficie in vista Exposed surface m ² /m	Jx cm ⁴	Wx cm ³	Jy cm ⁴	Wy cm ³
R62C59 R62D59	800730 A.0320.LN 800731		0,847	320	0,016	11,30	3,29	0,62	0,41
R62C60 R62D60	800788 A.0320.LN A.0319.LN 800591		1,783	600	0,157	31,19	9,32	27,89	5,70
R62C61 R62D61	800789 A.0320.LN A.0320.LN 800603		1,911	473	0,154	30,98	8,49	31,49	6,60
R62C62 R62D62	800797 A.0320.LN A.0320.LN 800796		1,871	458	0,158	24,91	8,19	28,40	5,92
R62C63 R62D63	800727 A.0320.LN A.0320.LN 800514		1,927	553	0,150	26,63	5,35	53,48	9,27
R62C64 R62D64	800727 A.0320.LN A.0320.LN 800516		2,047	618	0,177	32,41	6,23	58,29	9,75
R62C65 R62D65	800770 A.0320.LN A.0319.LN 800591		1,837	477	0,164	31,93	9,39	32,72	6,45
R62C66 R62D66	800802 A.0320.LN A.0319.LN 800585		1,399	460	0,119	23,03	7,16	11,05	2,90
R62C67 R62D67	800806 A.0320.LN A.0320.LN 800689		2,871	863	0,261	82,73	10,99	177,96	20,41
R62C68 R62D68	800805 A.0320.LN A.0319.LN 800591		1,798	507	0,161	31,08	9,28	31,86	6,32
R62C69 R62D69	800827 A.0320.LN A.0319.LN 800591		1,800	514	0,161	31,00	9,25	31,49	6,26
R62C70 R62D70	800827 A.0320.LN A.0320.LN 800828		2,393	725	0,166	30,77	5,84	96,40	14,03

Le lettere C e D presenti nei codici sopra riportati stanno ad indicare rispettivamente:
C = profili interno ed esterno più barrette assemblati - es. R62C41
D = profili interno ed esterno più barrette non assemblati - es. R62D41
N.B.: I profilati sono forniti in lunghezza di 6800 mm

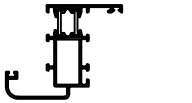
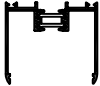
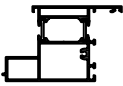
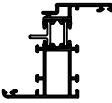
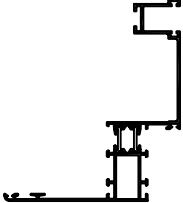
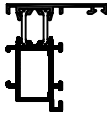

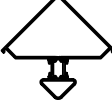
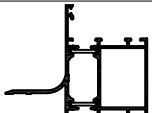
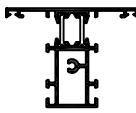
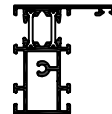
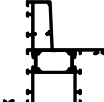
The letters C and D in the above codes indicate respectively:
C = Assembled internal and external sections with bars - ex. R62C41
D = Non assembled internal and external sections with bars - ex. R62D41
The sections are supplied with length of 6800 mm

Profilato Section	Comp.ne Composition	Sezione Cross section	Peso Weight Kg/m	Perimetro Perimeter mm	Superficie in vista Exposed surface m ² /m	Jx cm ⁴	Wx cm ³	Jy cm ⁴	Wy cm ³
R62C71 R62D71	800825 A.0320.LN A.0320.LN 800504		1,395	482	0,120	23,38	7,19	13,82	3,57
R62C111 R62D111	800830 A.0320.LN A.0320.LN 800830		1,096	417	0,108	8,26	2,26	19,03	6,28
R62C112 R62D112	800832 A.0320.LN A.0320.LN 800593		1,973	430	0,159	33,97	10,61	39,07	7,90
R62C113 R62D113	800831 A.0319.LN A.0320.LN 800585		1,347	444	0,109	22,33	7,14	8,87	2,42
R62C114 R62D114	800547 A.0320.LN A.0320.LN 800659		2,245	846	0,173	168,74	19,81	67,77	7,92
R62C115 R62D115	800504 A.0320.LN A.0320.LN 800835		1,087	324	0,061	11,59	3,51	4,97	1,55
R62C116 R62D116	800837 A.0320.LN A.0320.LN 800610		1,651	360	0,194	23,63	6,07	38,20	7,16
R62C117 R62D117	800838 A.0320.LN A.0320.LN 800610		1,774	387	0,221	40,31	7,56	40,27	7,55
R62C119 R62D119	800828 A.0320.LN A.0320.LN 800592		1,907	566	0,147	26,55	5,35	43,50	8,38
R62C121 R62D121	800508 A.0320.LN A.0320.LN 800852		1,340	415	0,112	16,11	4,92	9,11	2,52
R62C122 R62D122	800504 A.0320.LN A.0320.LN 800852		1,224	356	0,085	14,18	4,63	5,47	1,65
R62C123 R62D123	800859 A.0320.LN A.0320.LN 800591		2,111	598	0,187	66,05	11,63	31,66	6,13

Le lettere C e D presenti nei codici sopra riportati stanno ad indicare rispettivamente:
C = profili interno ed esterno più barrette assemblati - es. R62C41
D = profili interno ed esterno più barrette non assemblati - es. R62D41
N.B.: I profilati sono forniti in lunghezza di 6800 mm

The letters C and D in the above codes indicate respectively:
C = Assembled internal and external sections with bars - ex. R62C41
D = Non assembled internal and external sections with bars - ex. R62D41
The sections are supplied with length of 6800 mm

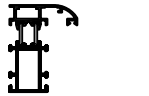
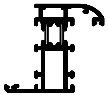
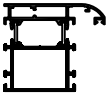
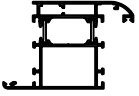
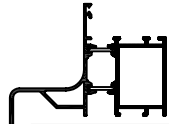
ELENCO PROFILATI
LIST OF SECTIONS

Profilato Section	Comp.ne Composition	Sezione Cross section	Peso Weight Kg/m	Perimetro Perimeter mm	Superficie in vista Exposed surface m ² /m	Jx cm ⁴	Wx cm ³	Jy cm ⁴	Wy cm ³
R62C144 R62D144	800917 A.0320.LN A.0320.LN 800588		1,403	413	0,093	21,26	5,75	7,57	2,34
R62C145 R62D145	800917 A.0320.LN A.0320.LN 800585		1,515	475	0,119	26,65	7,66	11,19	3,00
R62C146 R62D146	800918 A.0320.LN A.0320.LN 800592		1,816	464	0,140	30,04	7,89	26,90	6,10
R62C147 R62D147	800918 A.0320.LN A.0320.LN 800591		1,929	526	0,165	35,24	9,82	33,95	6,88
R62C153 R62D153	800690 A.0320.LN A.0320.LN 800925		2,352	702	0,248	76,51	10,00	104,07	18,40
R62C157 R62D157	800944 A.0320.LN A.0320.LN 800944		1,452	416	0,210	5,89	4,71	43,41	8,04

Le lettere C e D presenti nei codici sopra riportati stanno ad indicare rispettivamente:
C = profili interno ed esterno più barrette assemblati – es. R62C41
D = profili interno ed esterno più barrette non assemblati – es. R62D41
N.B.: I profilati sono forniti in lunghezza di 6800 mm

The letters C and D in the above codes indicate respectively:
C = Assembled internal and external sections with bars – ex. R62C41
D = Non assembled internal and external sections with bars – ex. R62D41
The sections are supplied with length of 6800 mm

ELENCO PROFILATI
LIST OF SECTIONS



Profilato Section	Sezione Cross section	Peso Weight Kg/m	Perim. Perim. mm	Sup. in vista Expose surface m /m ²	Profilato Section	Sezione Cross section	Peso Weight Kg/m	Perim. Perim. mm	Sup. in vista Expose surface m /m ²
100009		0,234	82	0,029	800585		0,758	284	0,054
100342		0,143	64	0,025	800586		0,710	247	0,034
800129		0,324	182	0,074	800587		0,461	213	0,073
800291		0,629	231	0,080	800588		0,646	221	0,028
800504		0,390	172	0,055	800589		1,519	395	0,114
800507		0,497	193	0,060	800590		1,637	459	0,141
800508		0,506	236	0,082	800591		0,942	333	0,077
800511		0,924	409	0,168	800592		0,829	271	0,052
800514		0,506	221	0,079	800593		1,148	285	0,074
800516		0,623	285	0,106	800594		1,085	308	0,108
800517		0,714	239	0,084	800595		1,609	432	0,170
800538		0,272	108	0,028	800596		0,859	328	0,090
800540		0,389	157	0,052	800597		0,880	350	0,082
800547		1,135	485	0,072	800598		1,063	399	0,106
800548		0,988	420	0,040	800599		0,902	257	0,080
800575		1,315	416	0,125	800601		0,830	241	0,043
800581		0,314	163	0,015	800603		0,987	271	0,052

ELENCO PROFILATI
LIST OF SECTIONS

Profilato Section	Sezione Cross section	Peso Weight Kg/m	Perlm. Perim. mm	Sup. in vista Expose surface m /m ²	Profilato Section	Sezione Cross section	Peso Weight Kg/m	Perlm. Perim. mm	Sup. in vista Expose surface m /m ²
800604		0,949	376	0,088	800701		0,834	324	0,072
800605		0,713	258	0,037	800705		0,940	366	0,094
800607		0,790	292	0,059	800722		0,513	164	0,061
800608		0,763	285	0,055	800727		1,315	431	0,071
800613		0,911	363	0,074	800728		0,297	122	0,042
800617		1,370	381	0,206	800729		0,383	159	0,058
800618		0,515	163	0,060	800730		0,313	131	0,000
800621		0,569	162	0,062	800731		0,502	197	0,016
800622		0,789	219	0,080	800737		0,980	333	0,105
800627		0,826	278	0,083	800738		0,170	92	0,027
800628		0,464	176	0,055	800739		0,899	291	0,090
800648		0,602	229	0,060	800759		1,370	469	0,185
800649		0,505	197	0,061	800760		1,043	354	0,185
800650		0,802	222	0,083	800761		1,193	389	0,165
800659		1,004	518	0,156	800762		1,542	540	0,222
800689		1,188	423	0,071	800770		0,761	210	0,087
800690		1,431	531	0,196	800780		0,432	216	0,027

ELENCO PROFILATI
LIST OF SECTIONS

Profilato Section	Sezione Cross section	Peso Weight Kg/m	Perlm. Perim. mm	Sup. in vista Expose surface m /m ²	Profilato Section	Sezione Cross section	Peso Weight Kg/m	Perlm. Perim. mm	Sup. in vista Expose surface m /m ²
800788		0,707	229	0,080	800838		1,218	304	0,164
800789		0,818	300	0,102	800839		0,498	188	0,080
800796		0,769	235	0,052	800852		0,728	222	0,030
800797		0,996	362	0,106	800859		1,063	356	0,110
800802		0,507	197	0,065	800917		0,651	234	0,065
800804		0,779	263	0,059	800918		0,881	286	0,088
800805		0,722	245	0,084	800925		0,815	259	0,052
800806		1,577	101	0,190	800944		0,673	267	0,100
800822		0,228	128	0,062	900106		0,262	152	0,062
800825		0,899	349	0,065	900162		0,370	202	0,070
800827		0,724	246	0,084	900221		0,167	57	0,015
800828		0,972	383	0,095	900316		0,213	133	0,068
800830		0,495	221	0,054	900317		0,850	312	0,055
800831		0,455	175	0,055	900318		0,786	285	0,052
800832		0,719	236	0,085	900319		0,413	138	0,000
800835		0,591	201	0,006	900362		0,440	187	0,000
800837		1,095	278	0,137	900390		0,286	104	0,030

Codice Code	Sezione Cross section	Peso Weight Kg/m
A.0319.LN		0,078
A.0320.LN		0,052

Scala 1:1
Scale 1:1

A.0319.LN

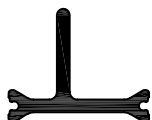

A.0320.LN



N.B.: I profilati sono forniti in lunghezza di 6800 mm

The sections are supplied with length of 6800 mm

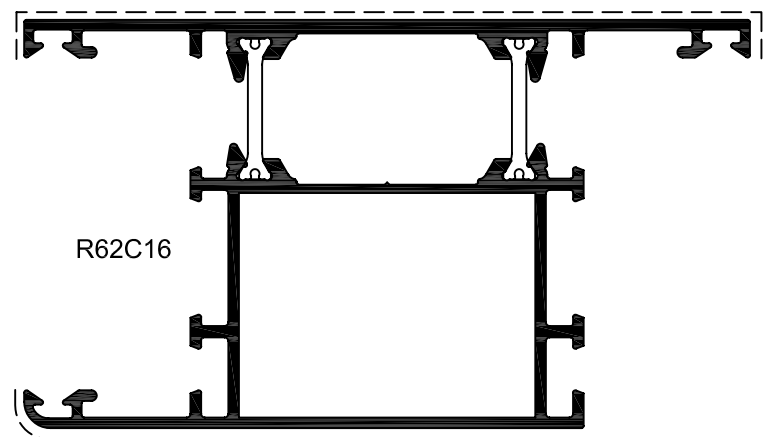
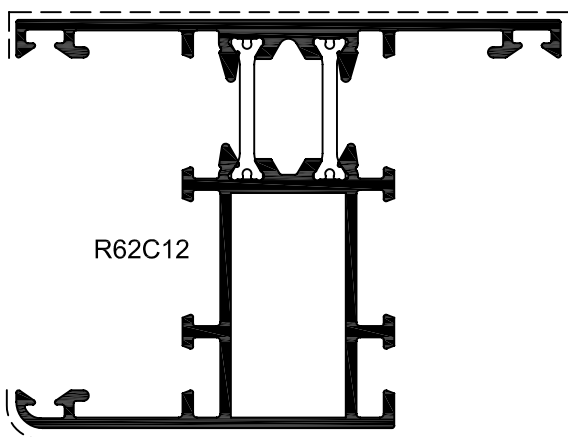
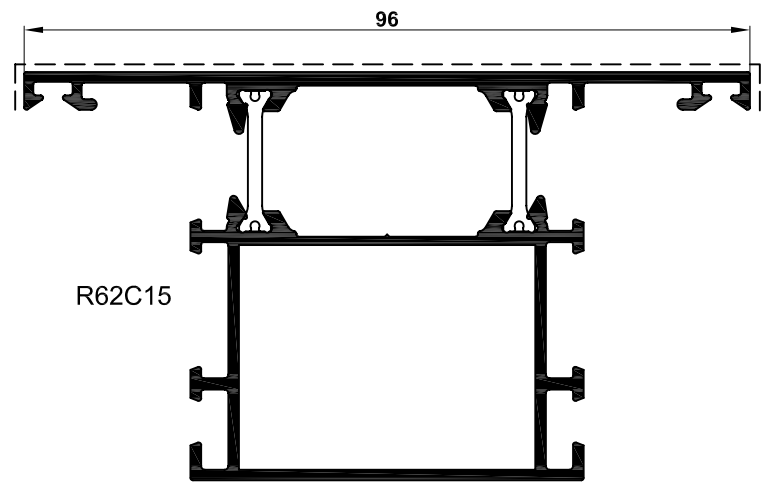
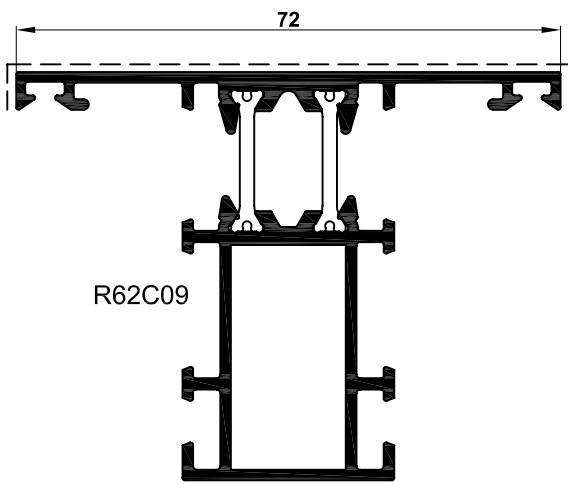
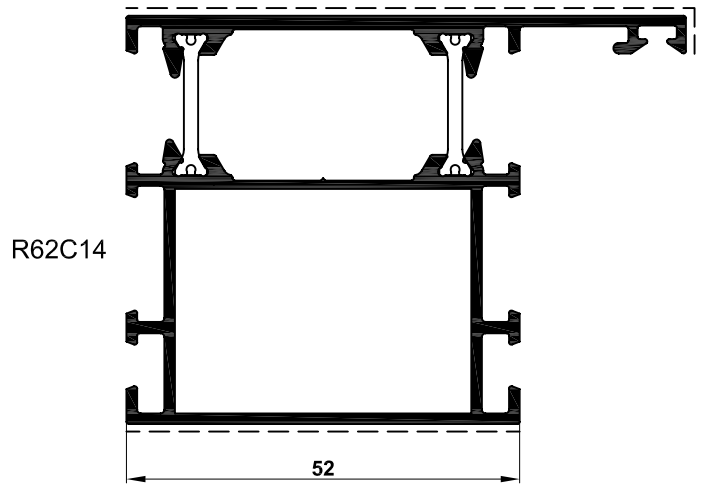
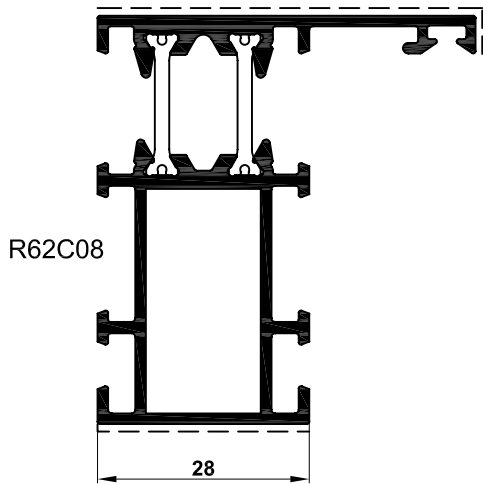
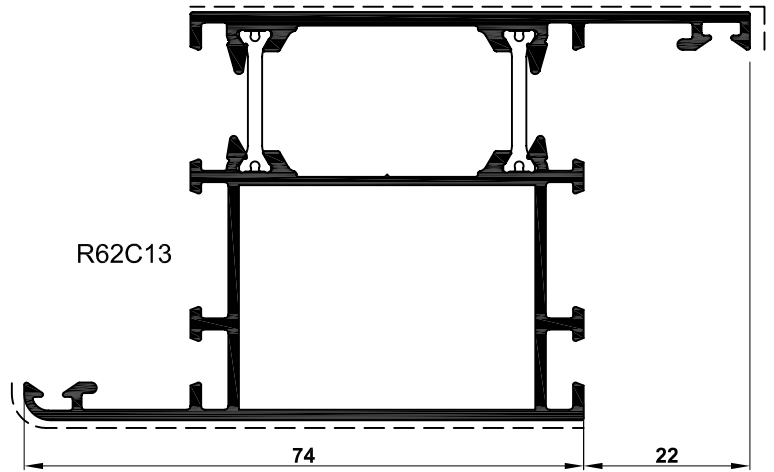
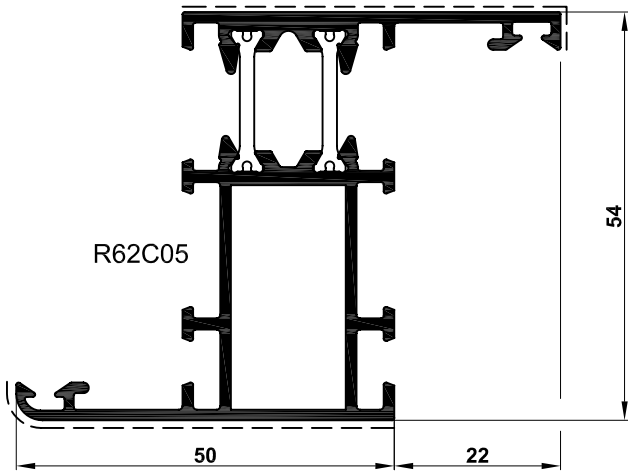

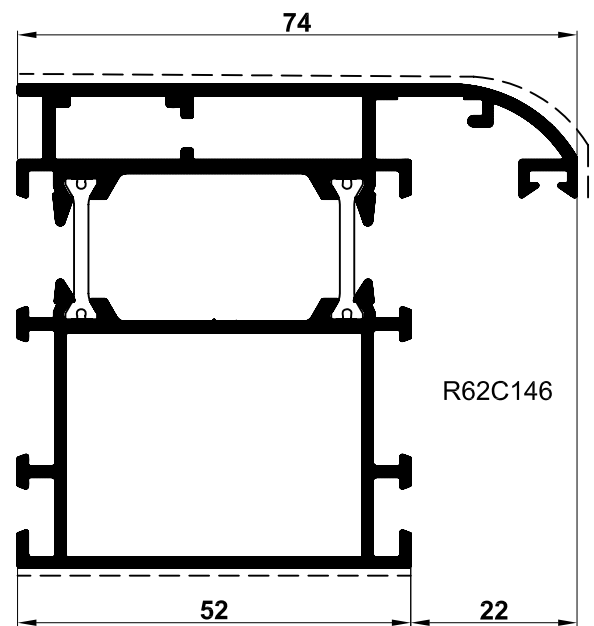
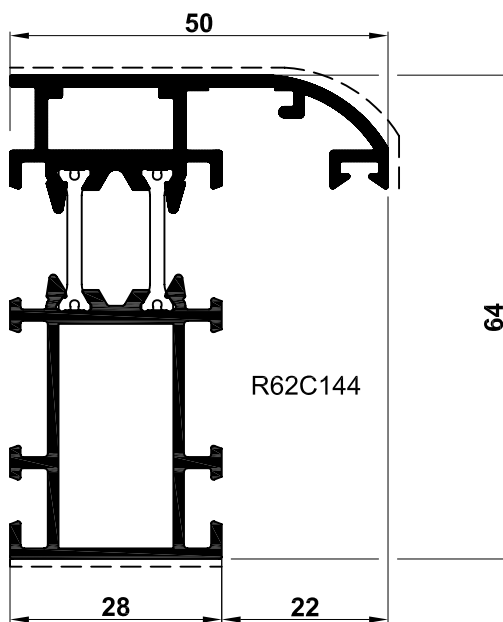
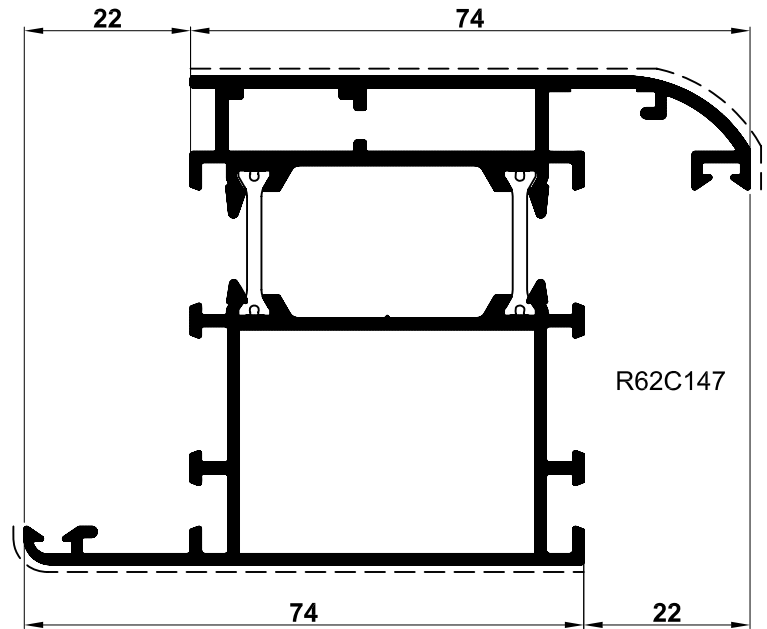
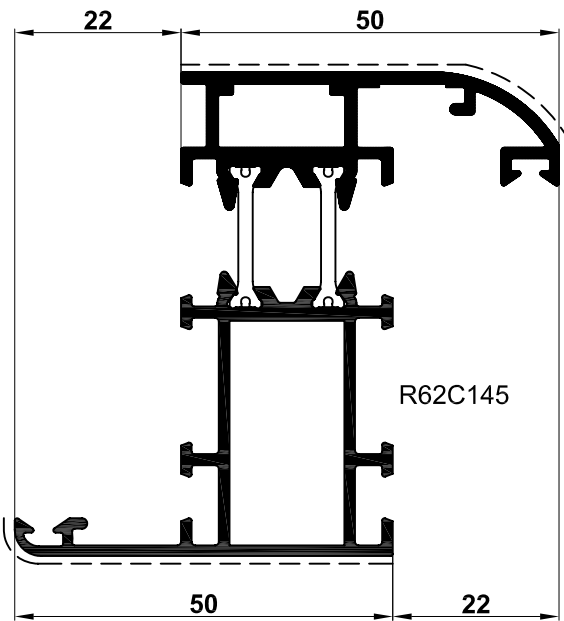
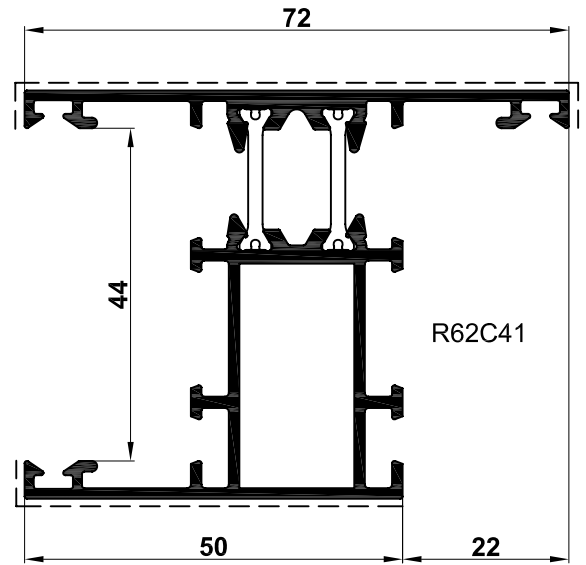
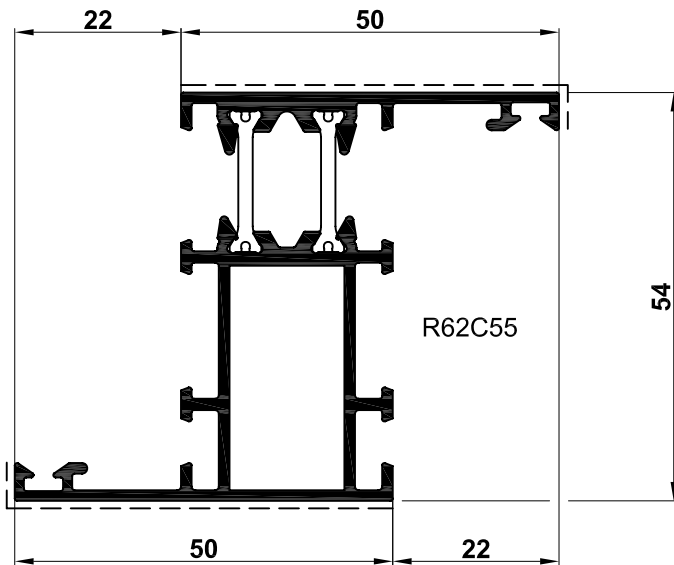

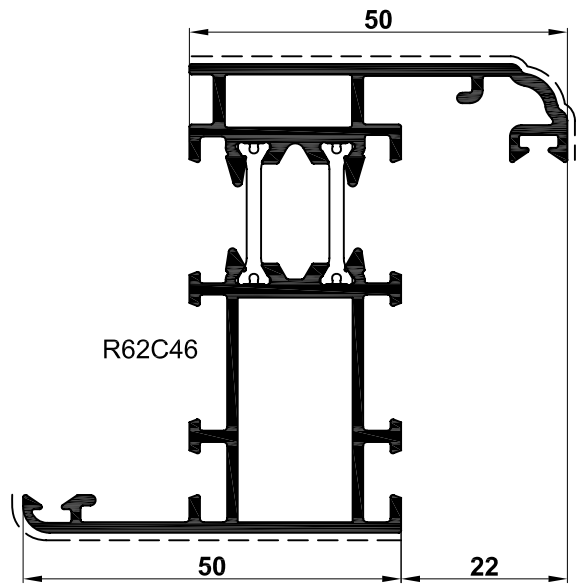
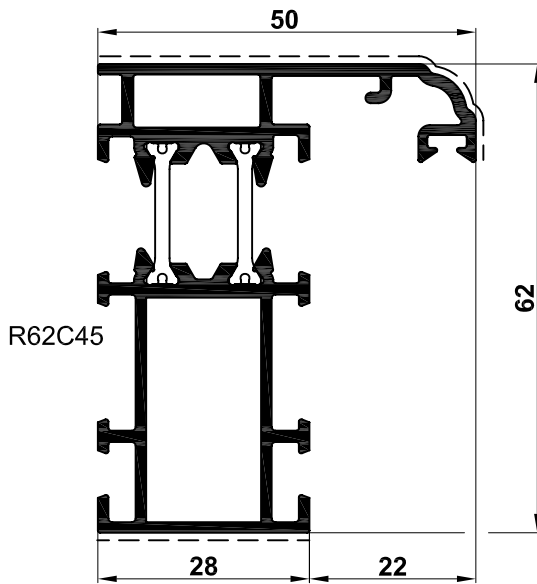

TELAI SPECIALI
SPECIAL FRAMES

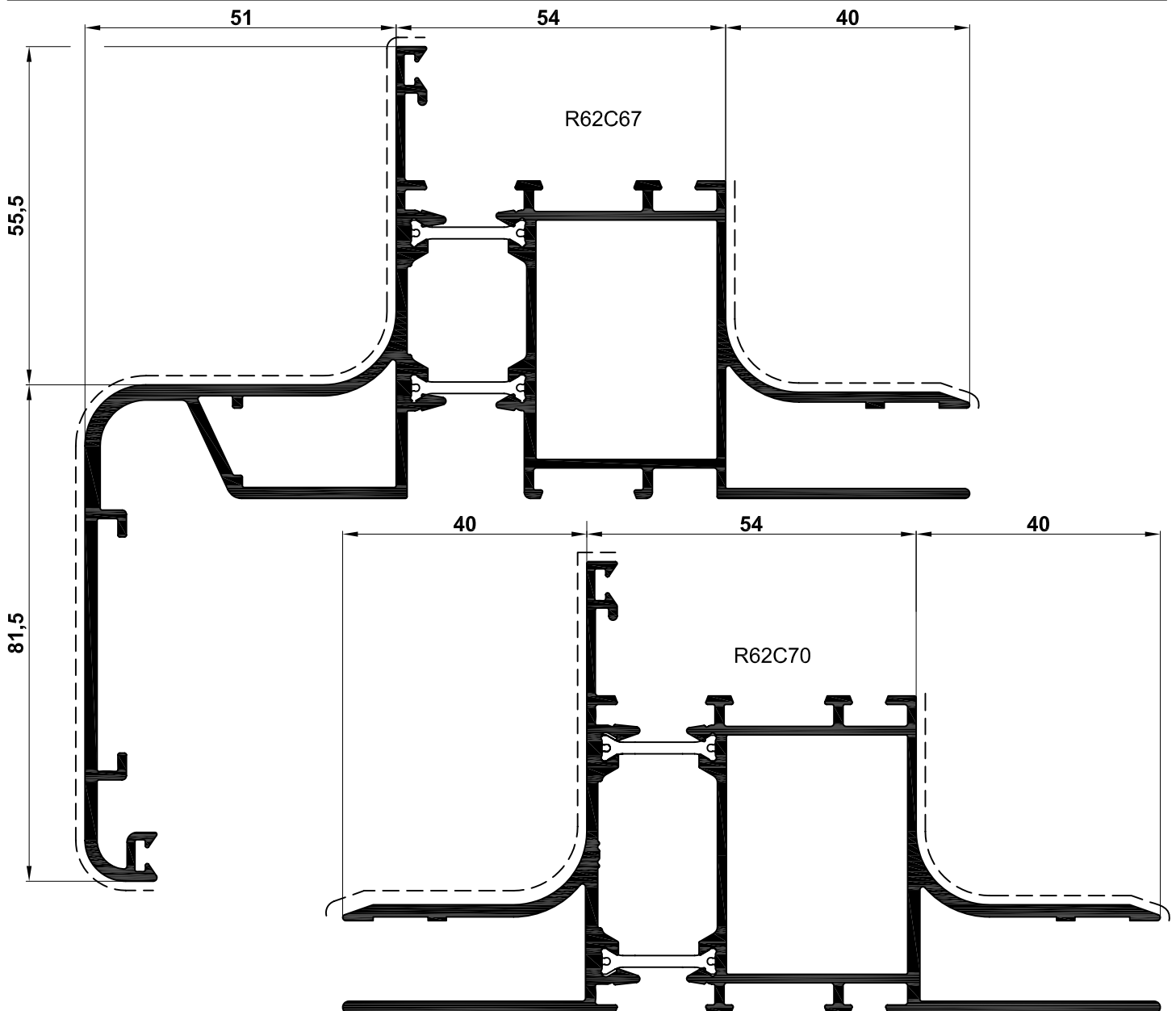

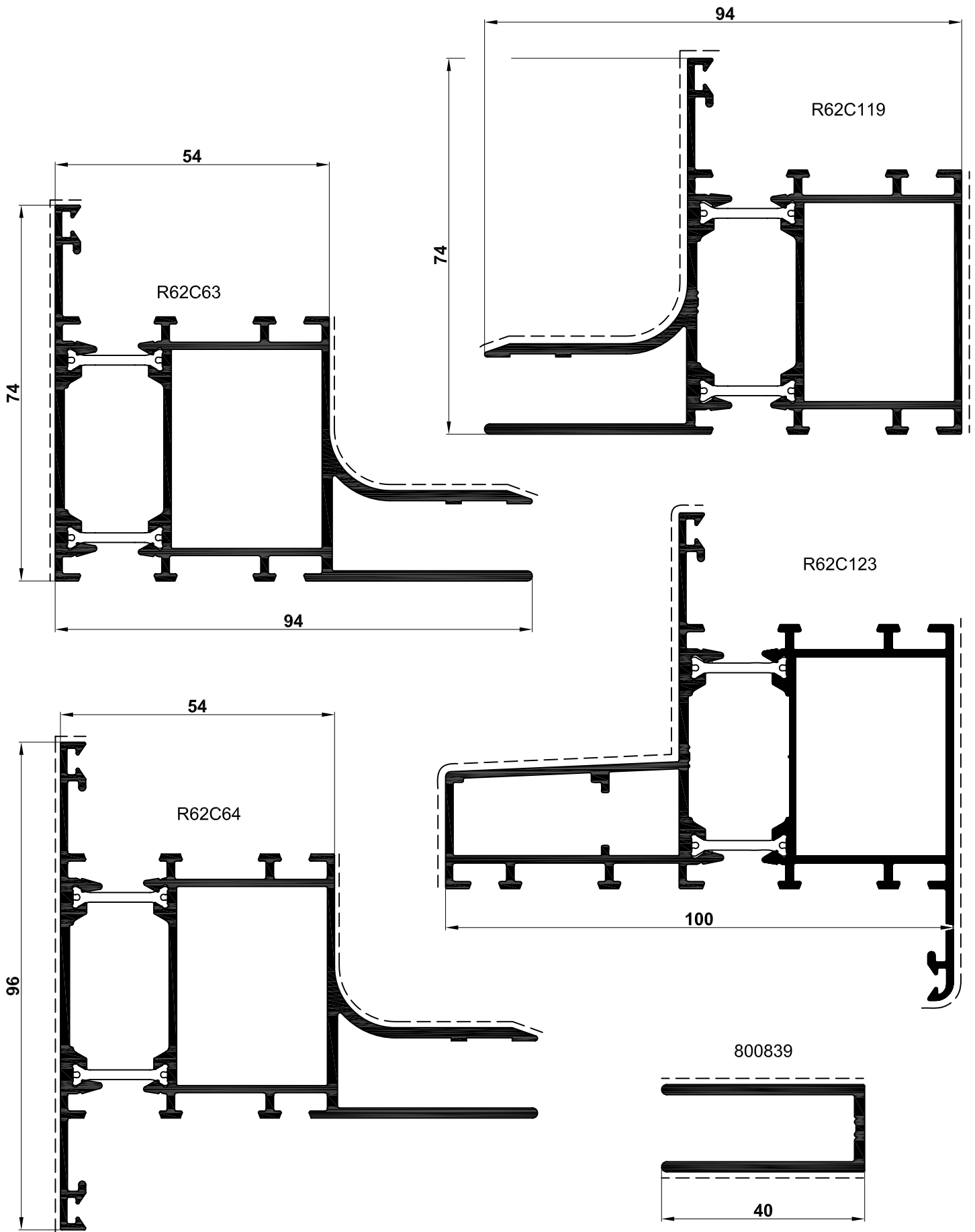

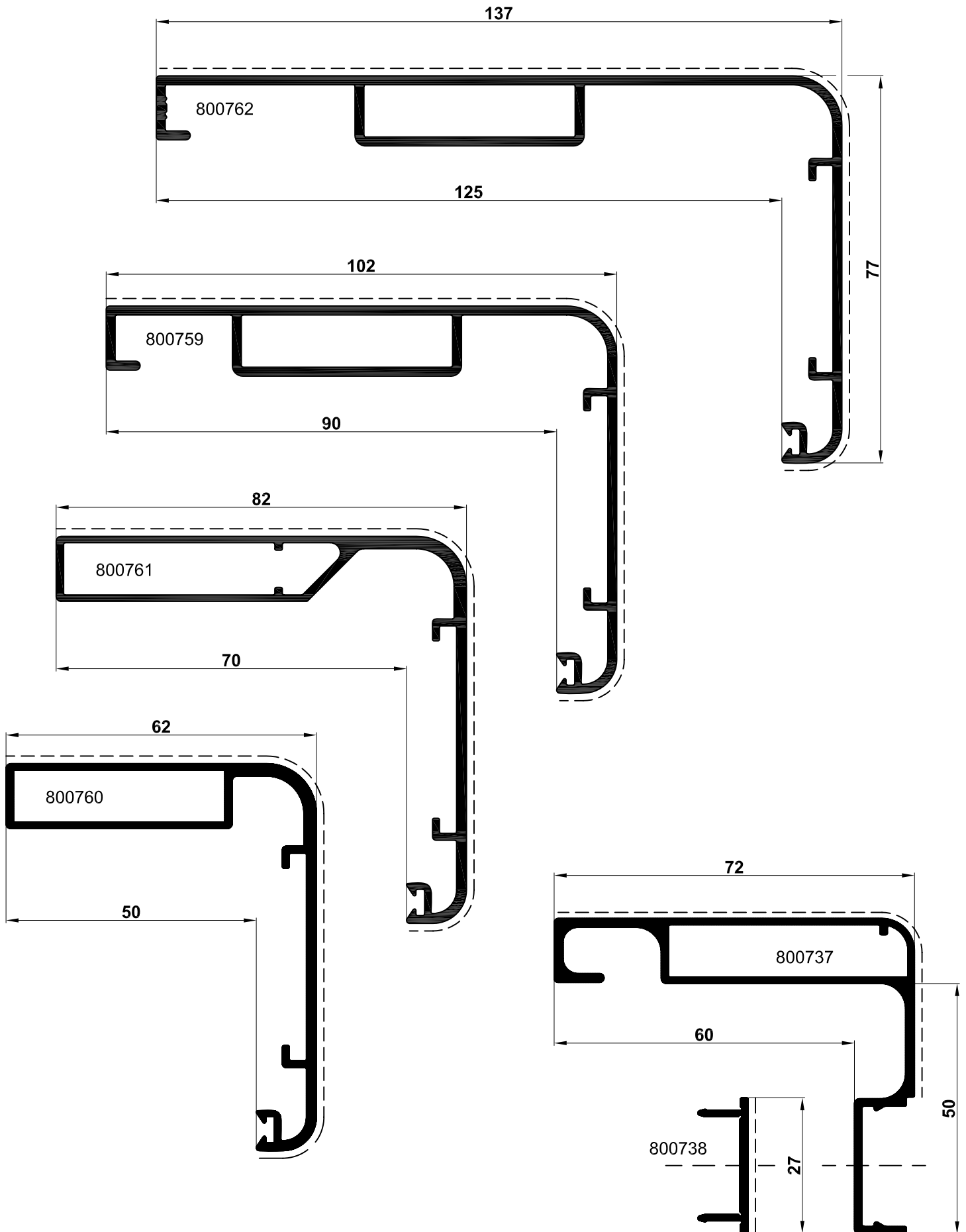

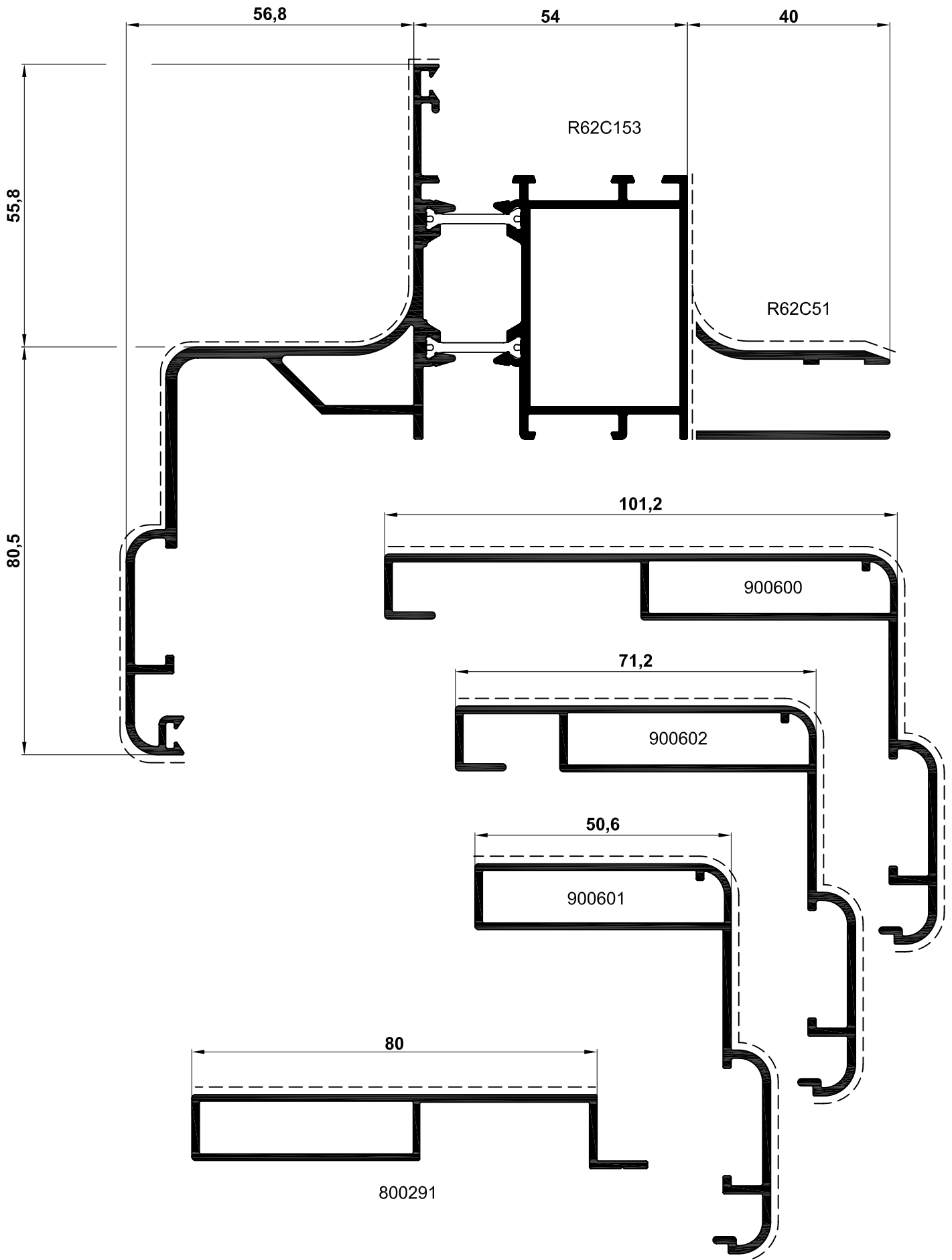



PROFILATI PER SOGLIA
FRAME SECTIONS

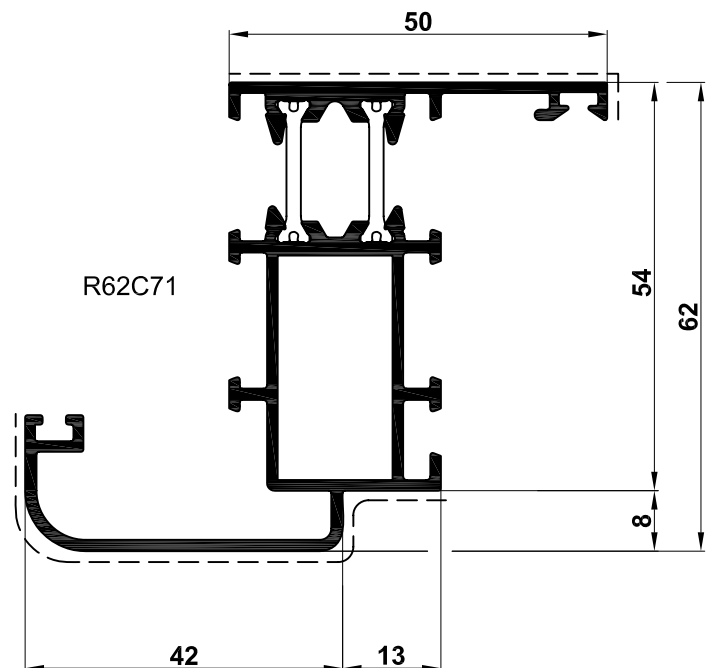
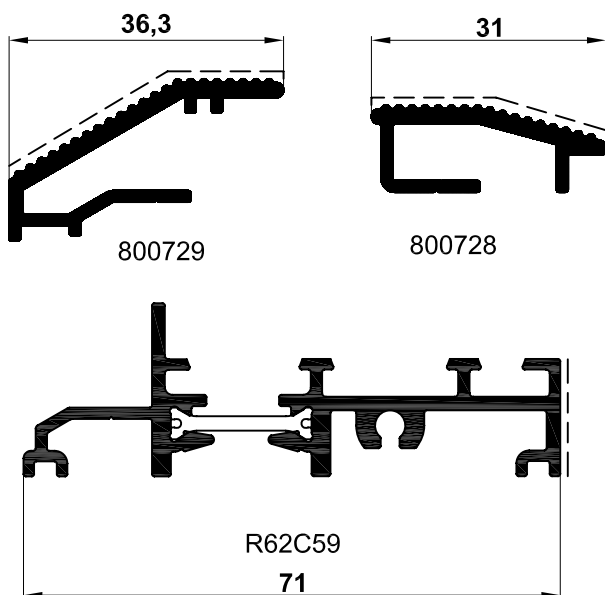

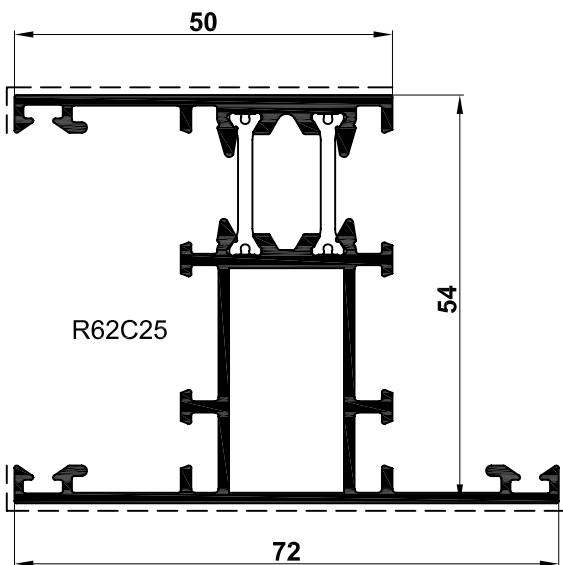
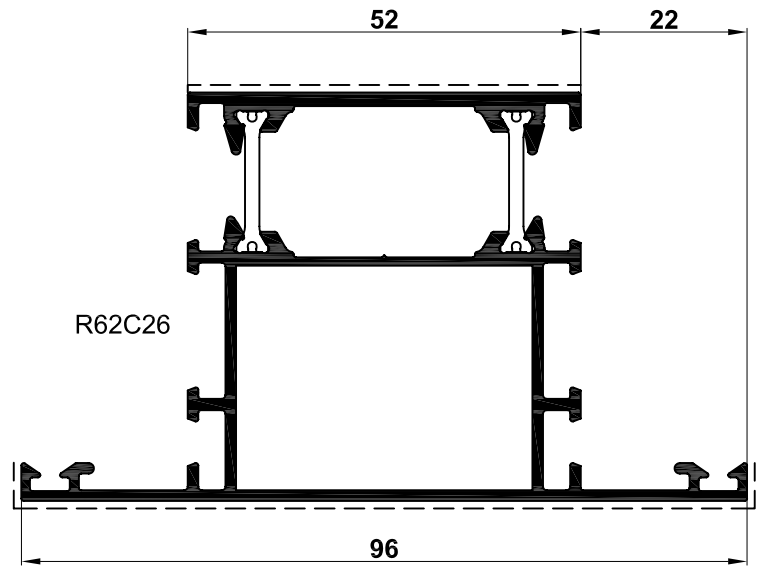
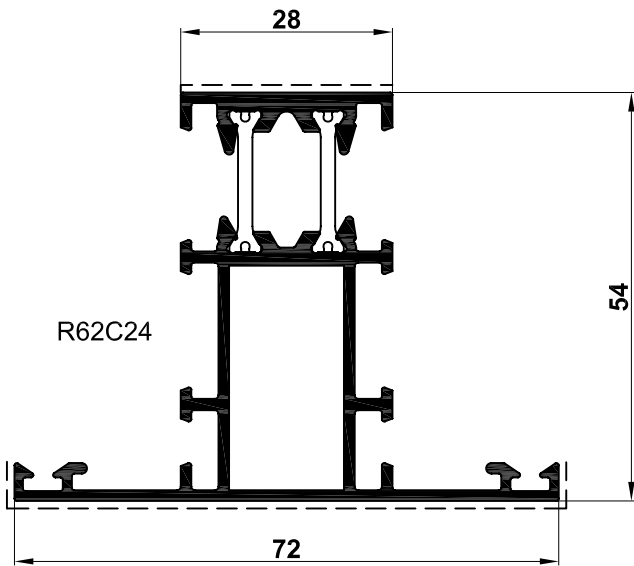
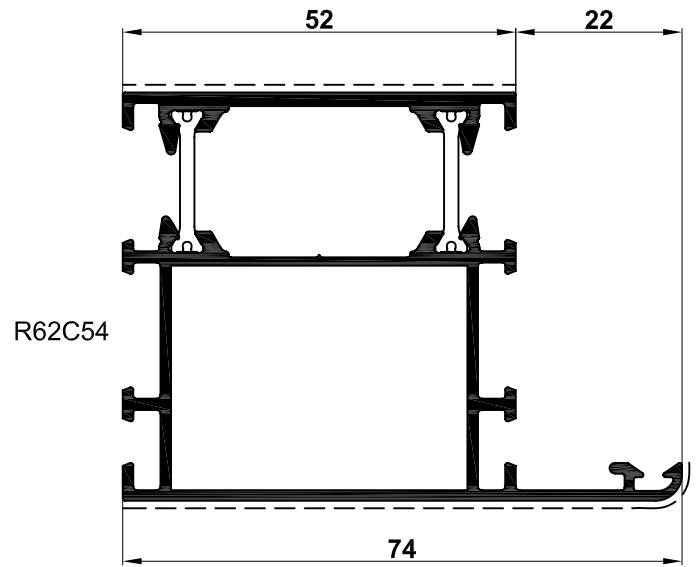
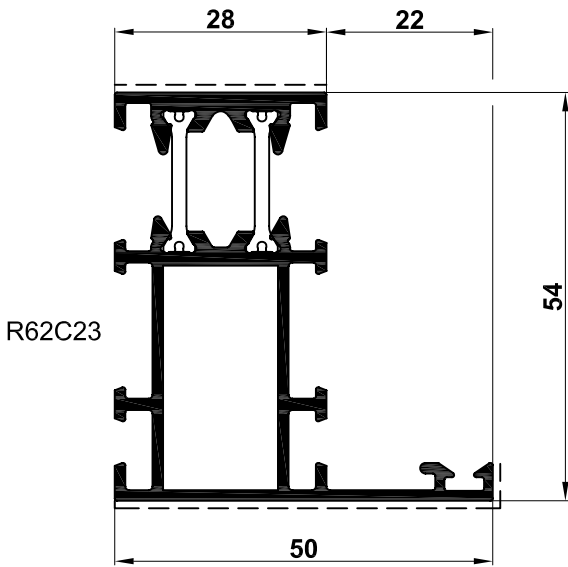

ANTA PER APERTURE ESTERNE
WING FOR OUTWARD OPENING

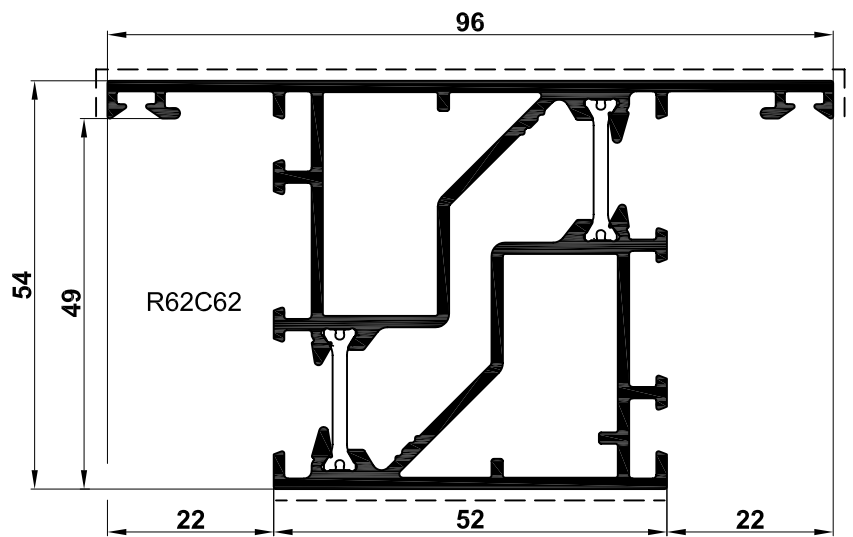

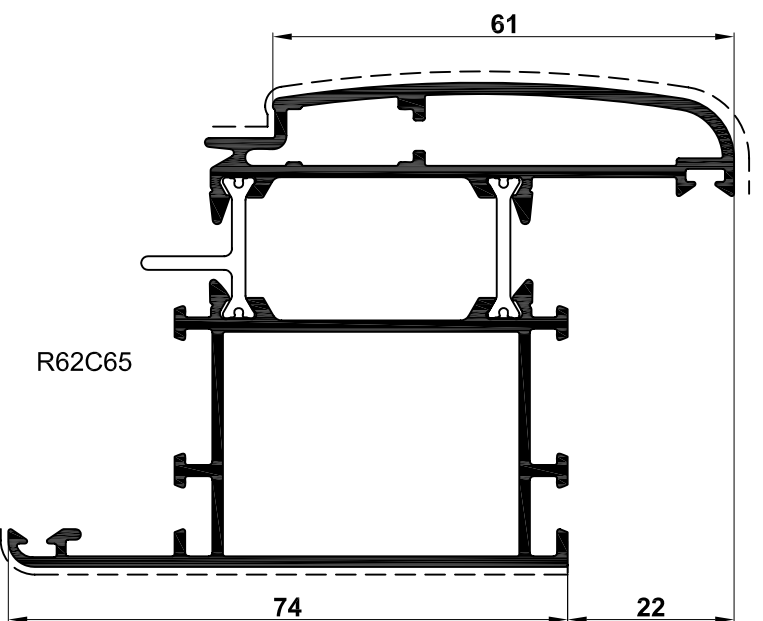
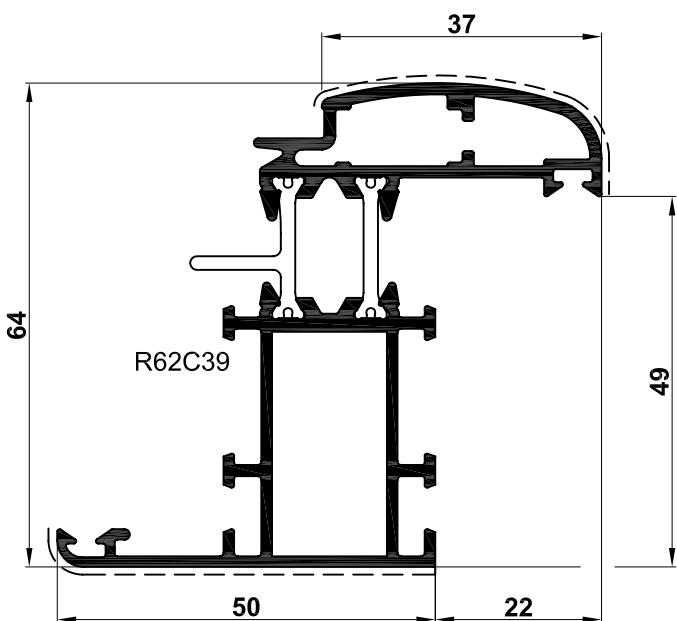
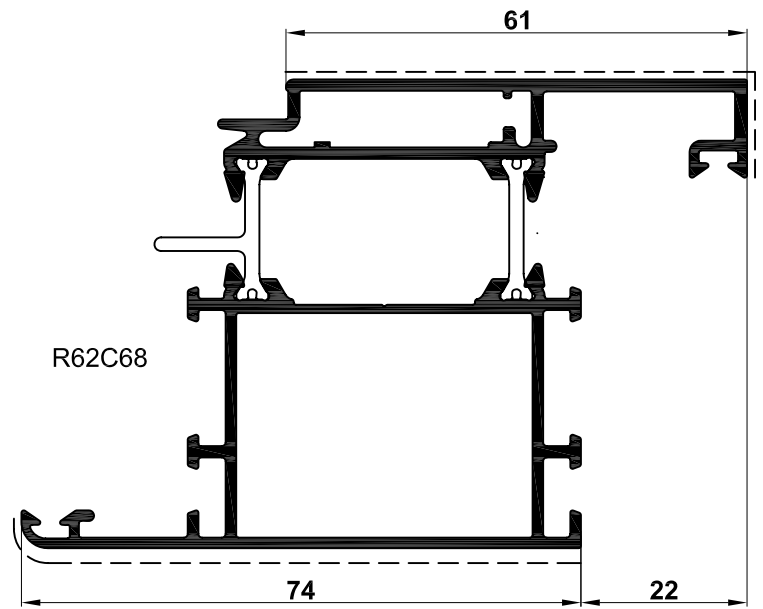
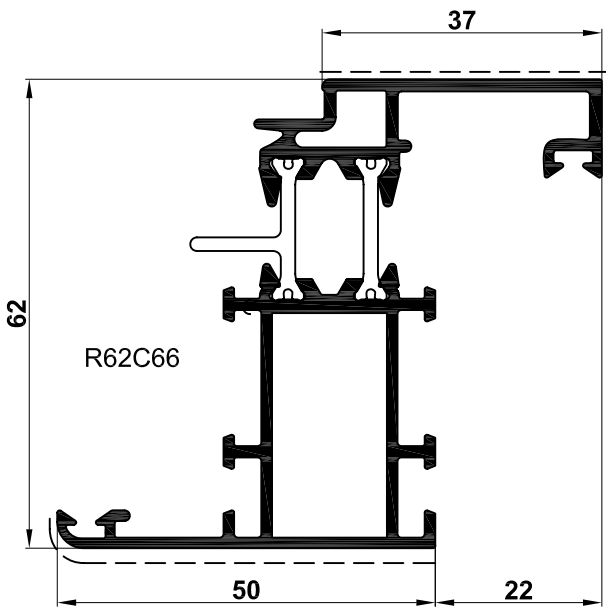
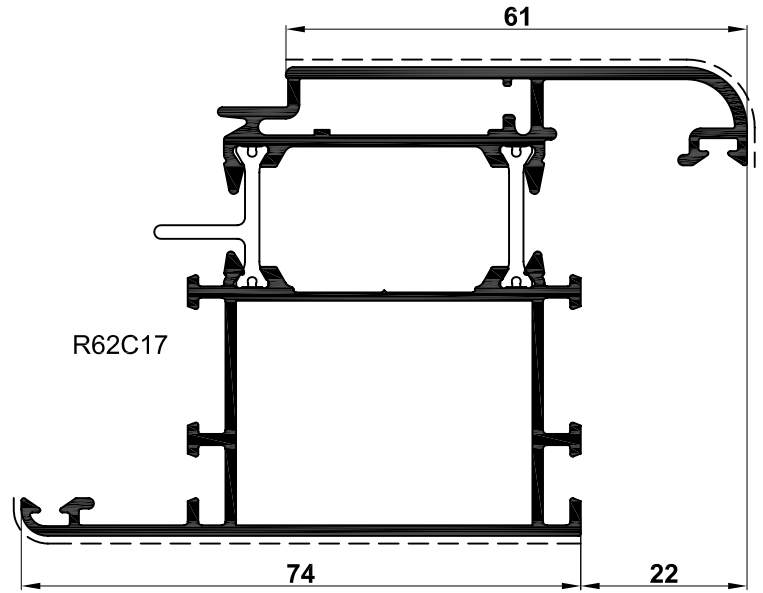
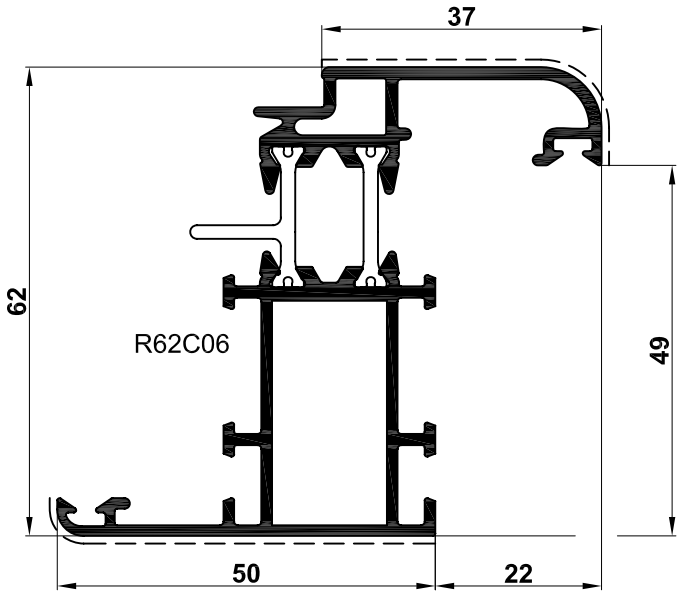

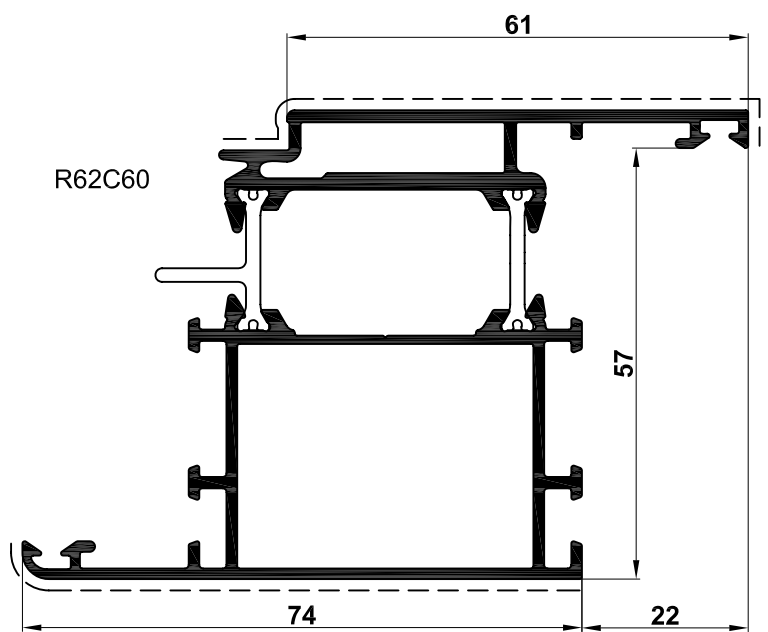
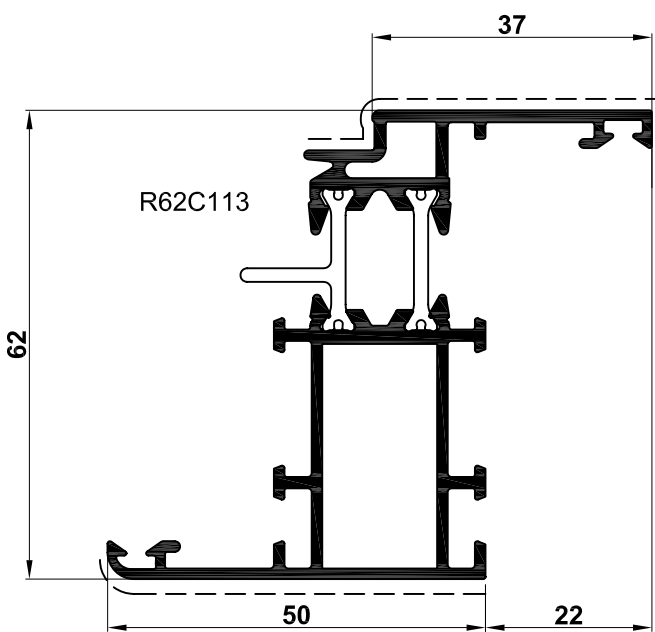
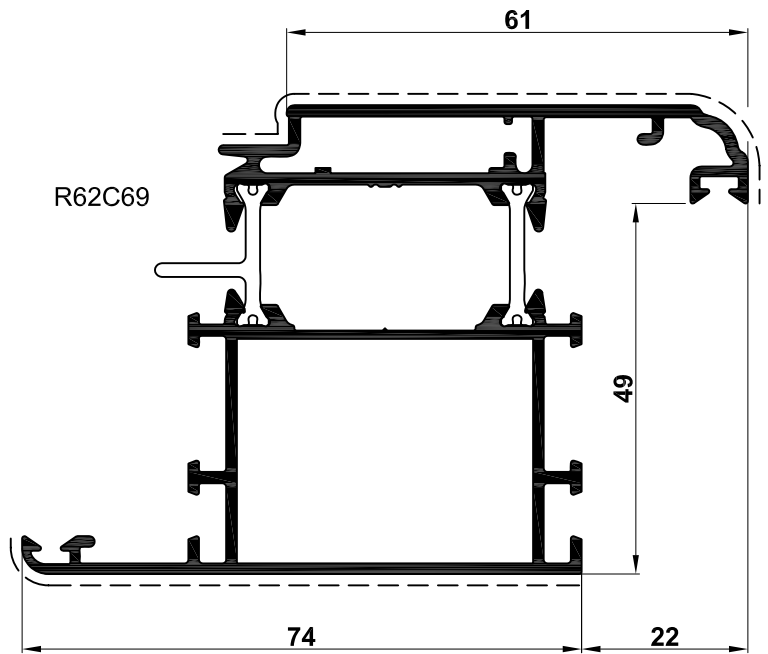
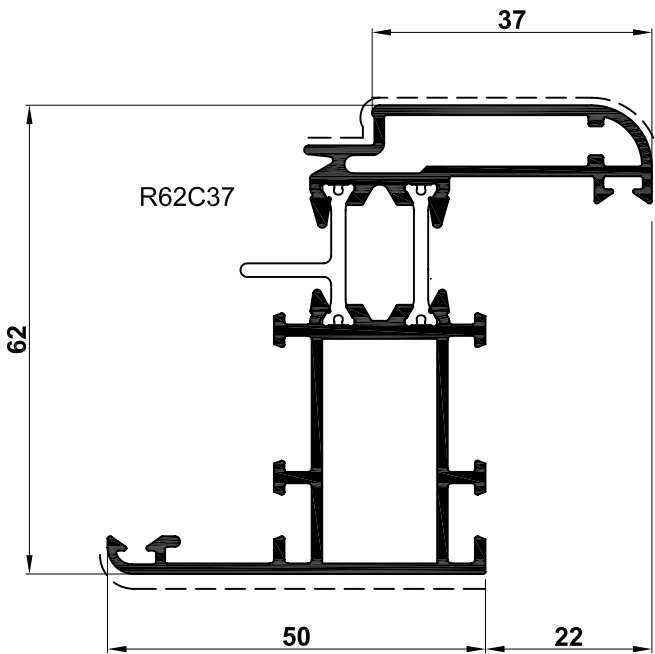
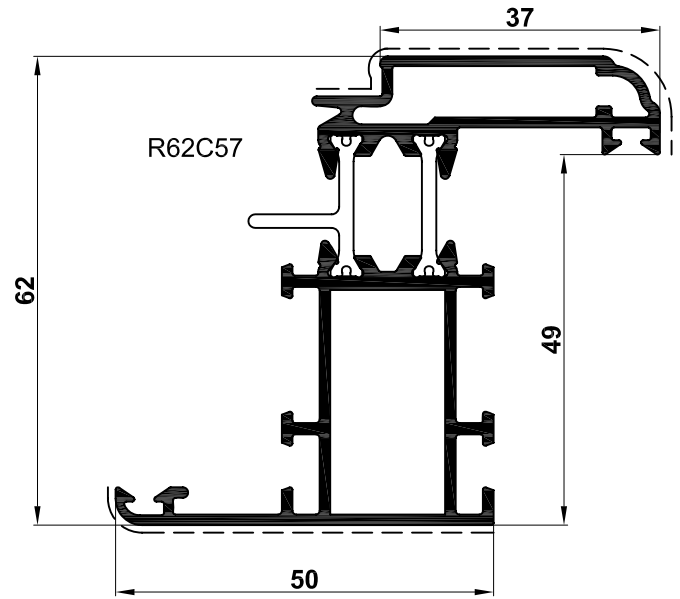
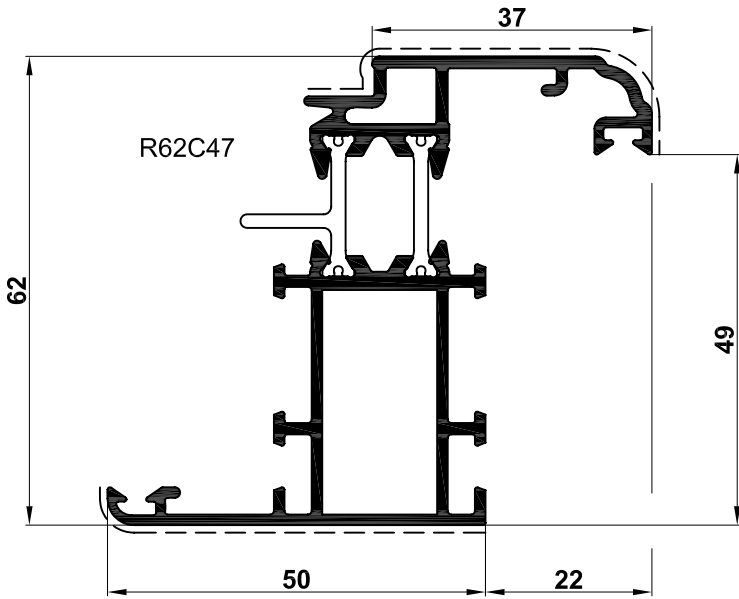

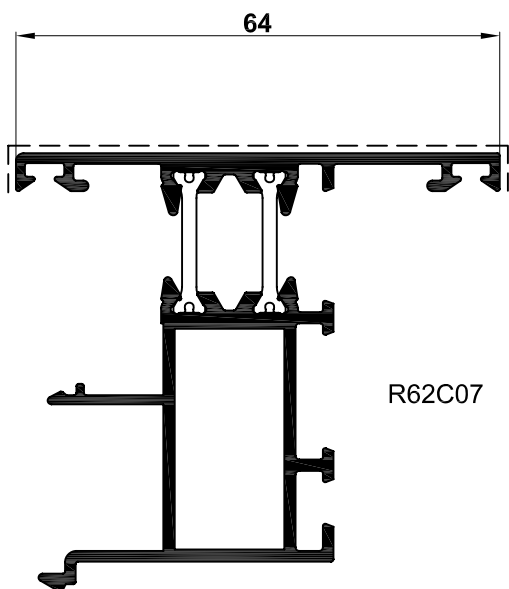

R62C07

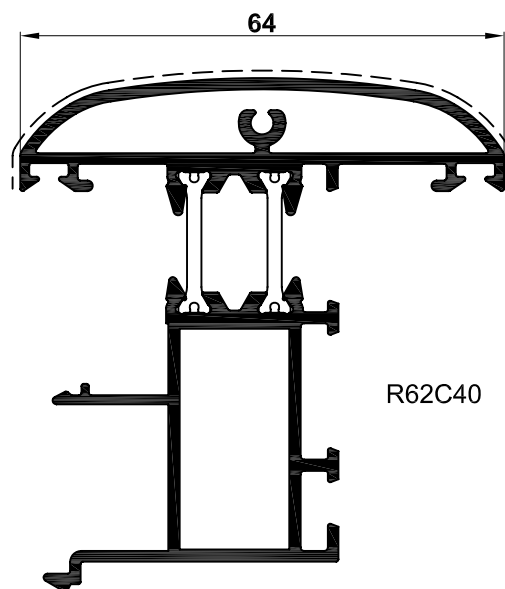

R62C40

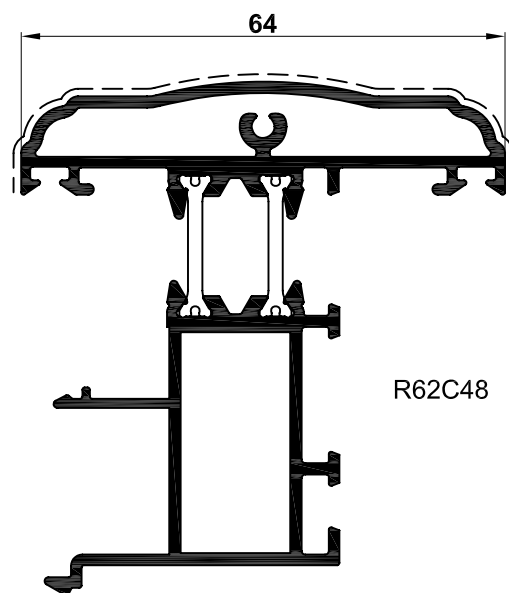

R62C48

RIPORTO CENTRALE - APERTURE ESTERNE
CENTRAL FILLING - OUTWARD OPENING

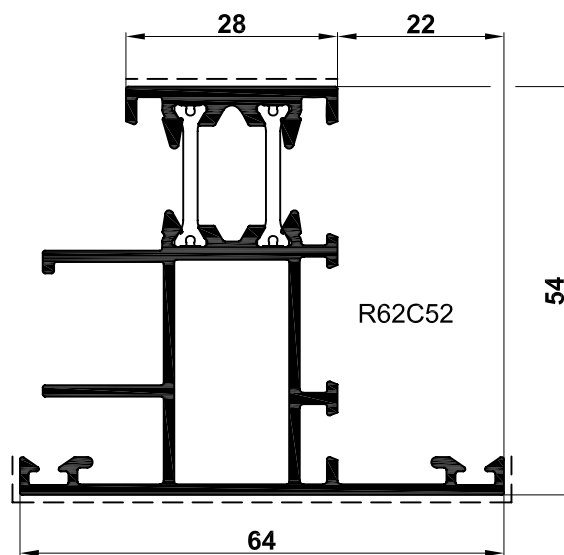

R62C52

INVERSIONE PER BILICO
INVERSION FOR PIVOTING WINDOW

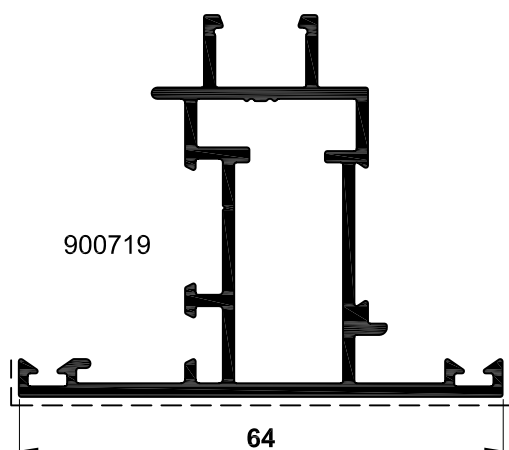

900719

INVERSIONE DI BATTUTA
RABBIT INVERSION

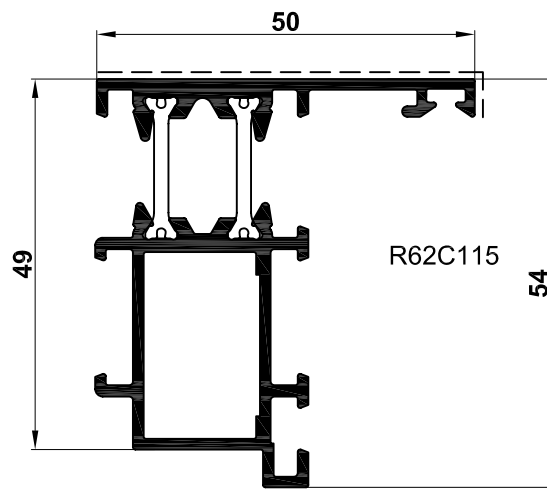

R62C115

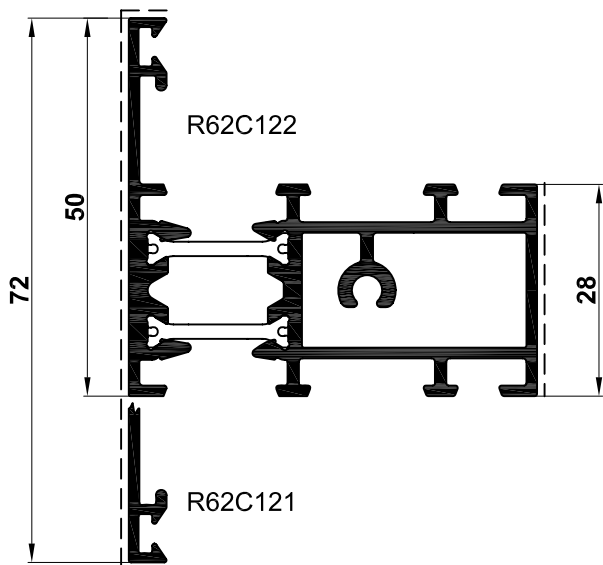
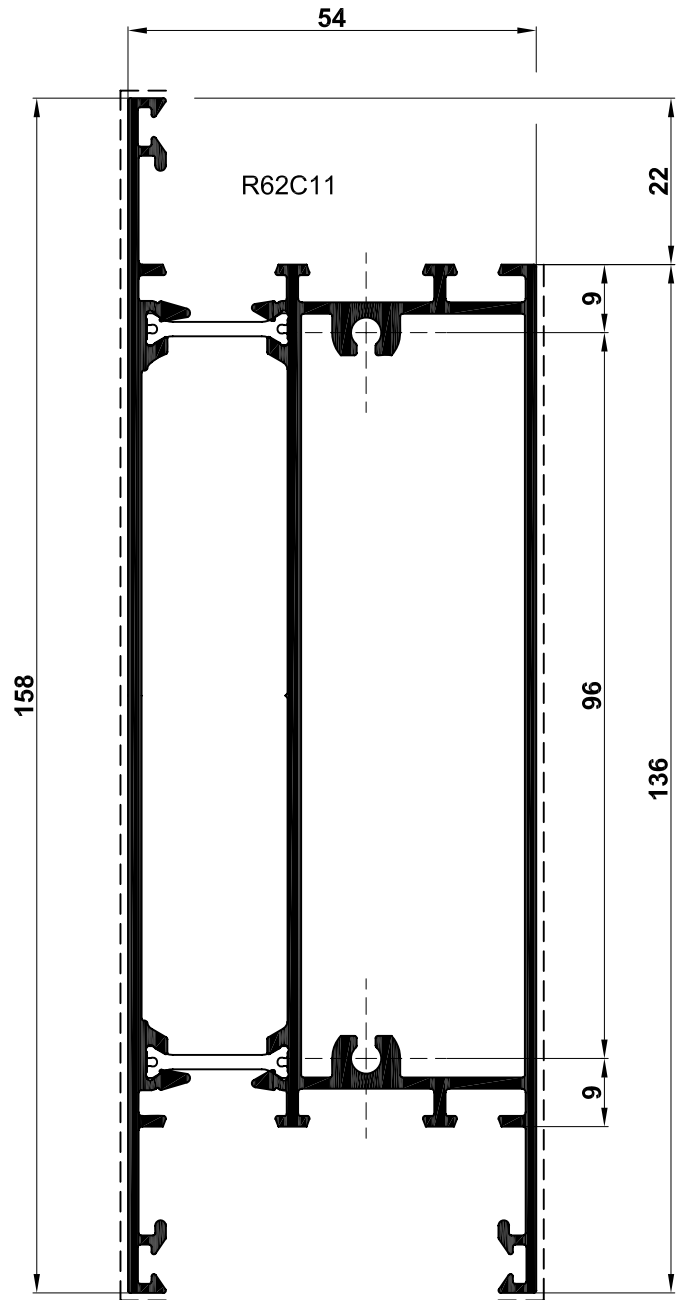
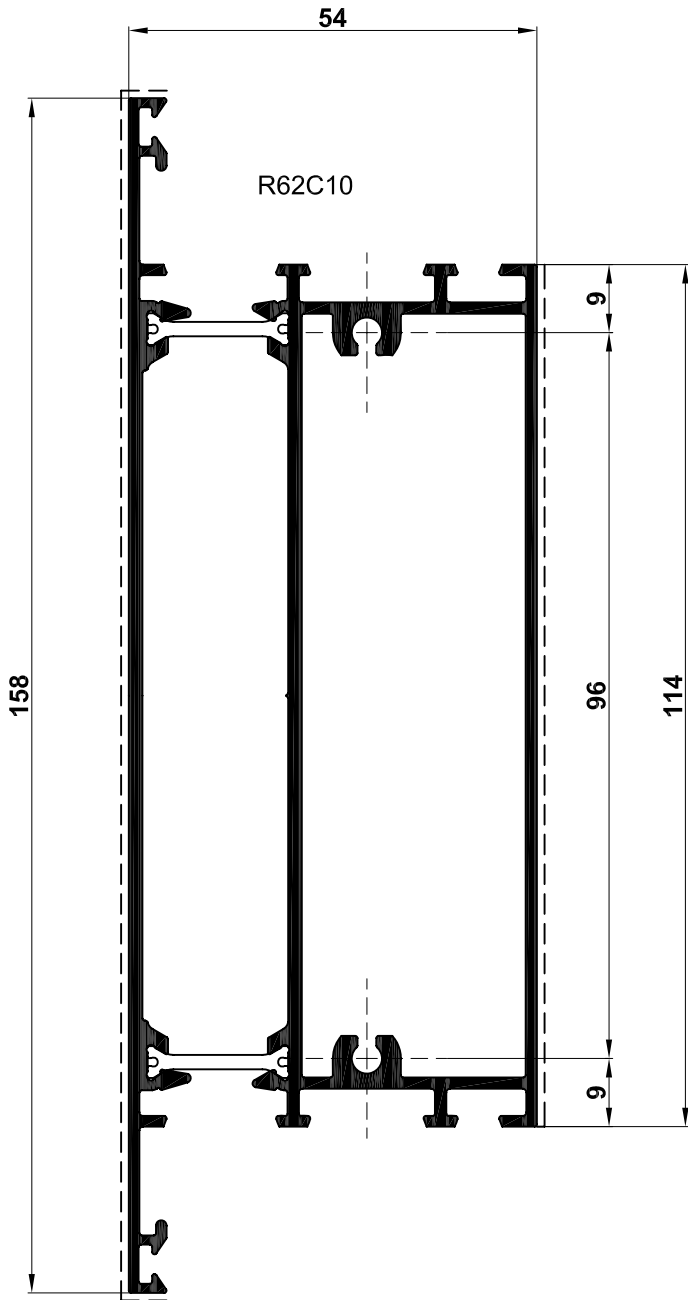

BATTUTA SOGLIA SOTTOZOCICOLO
THRESHOLD RABBET UNDER SKIRTING BOARD

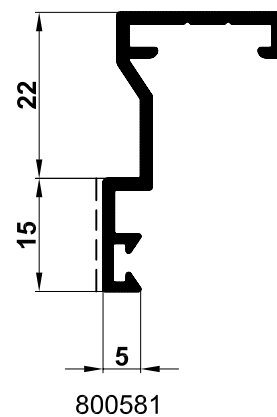

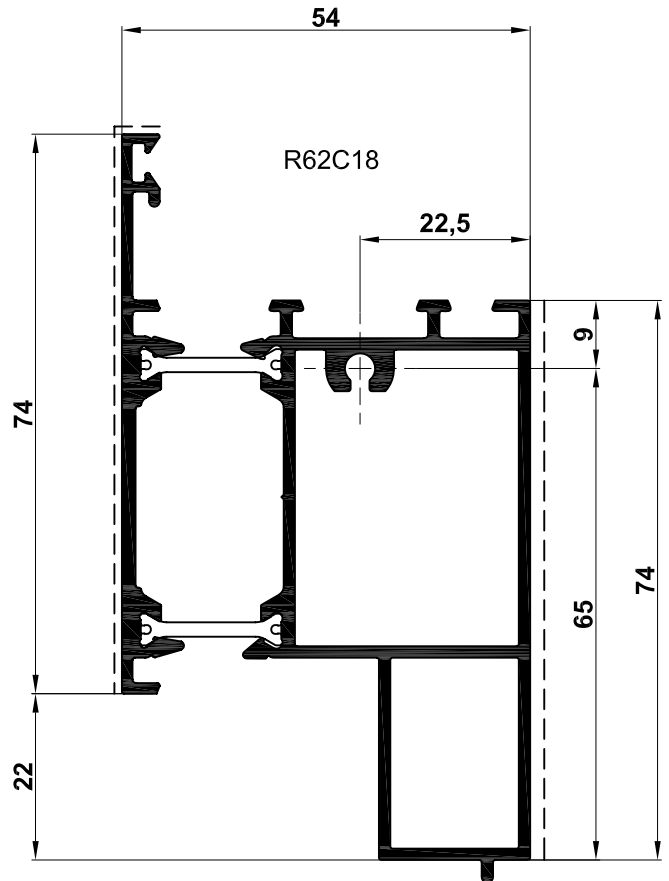
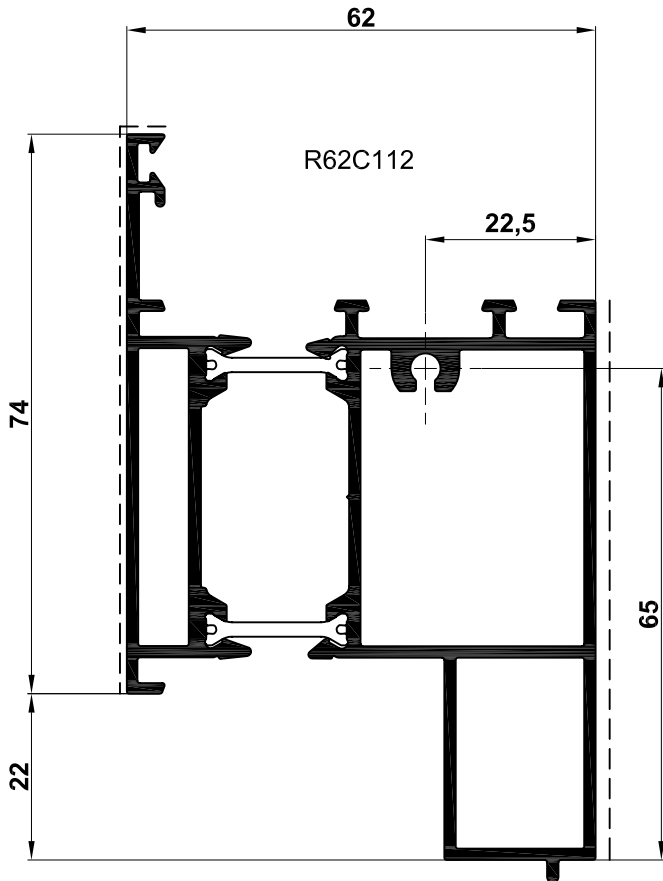
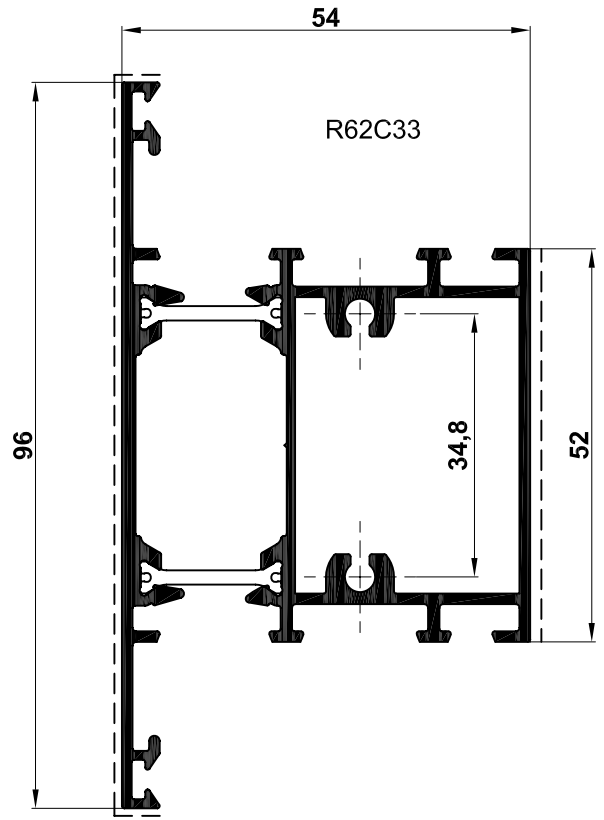
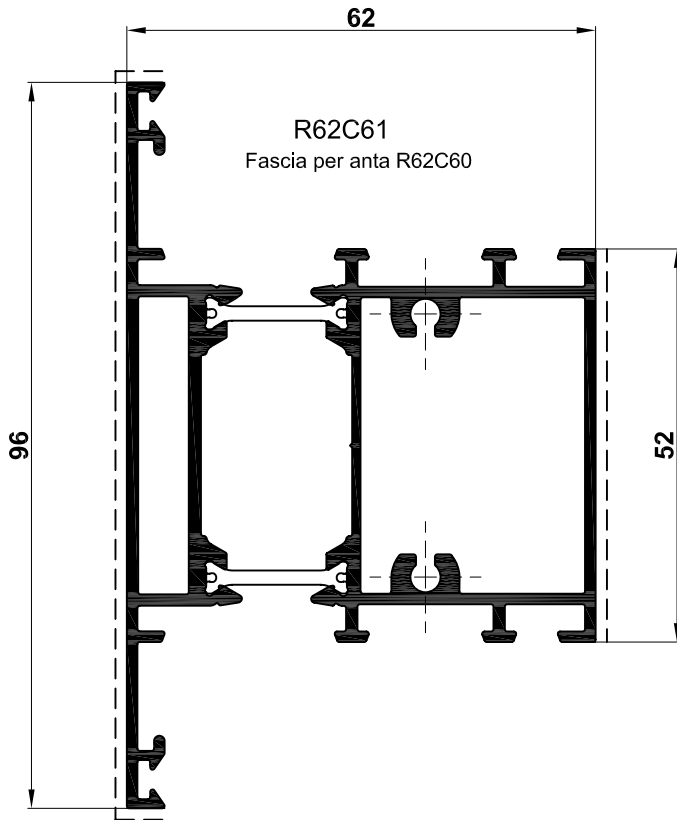

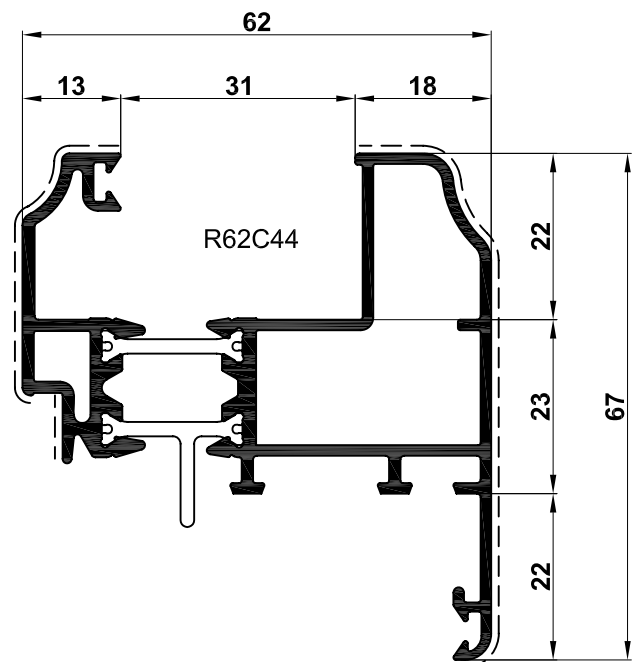
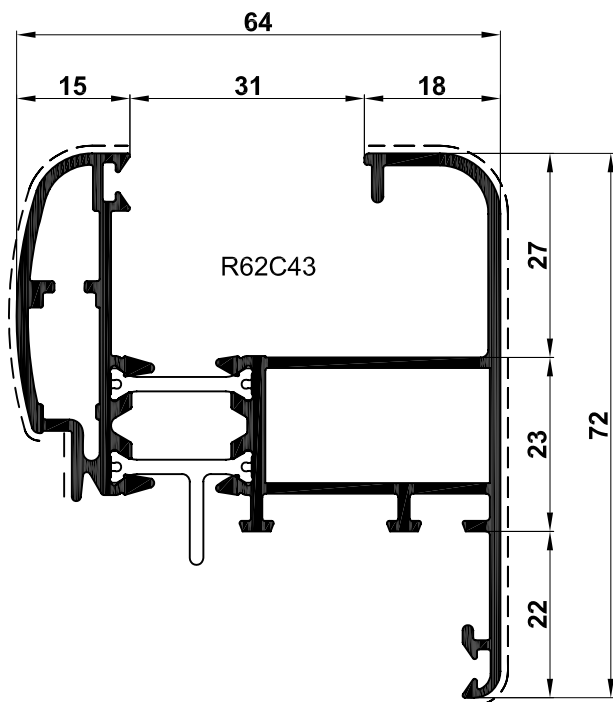
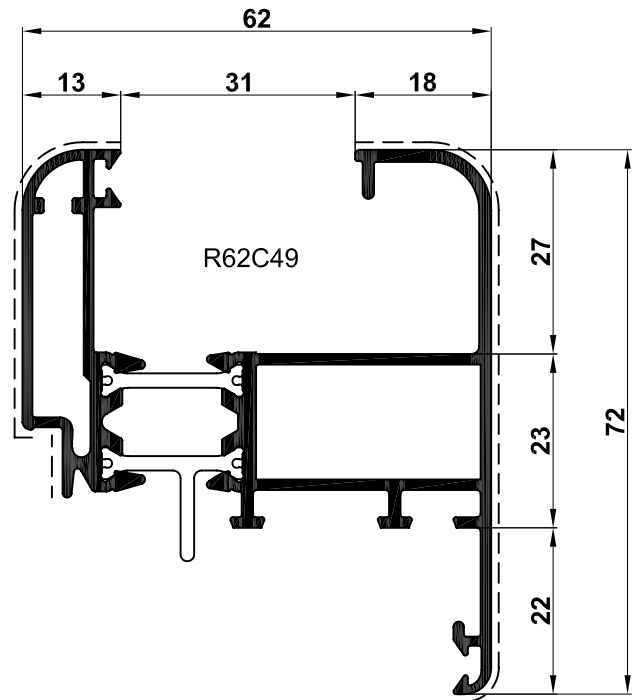
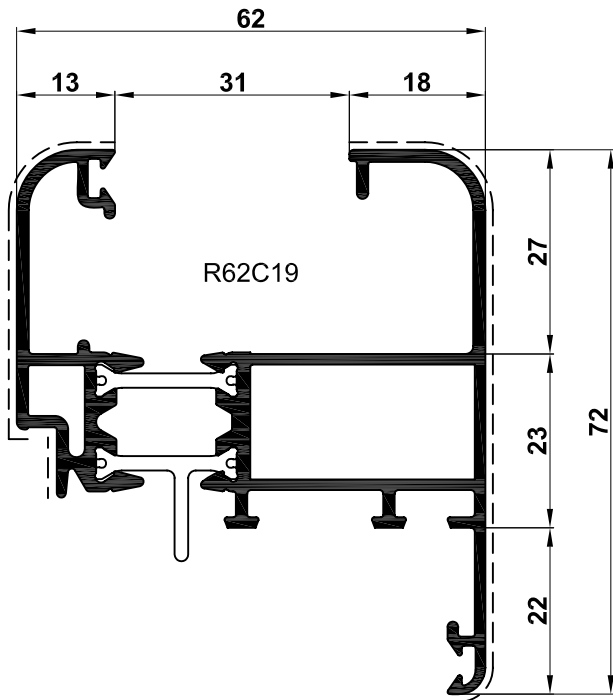

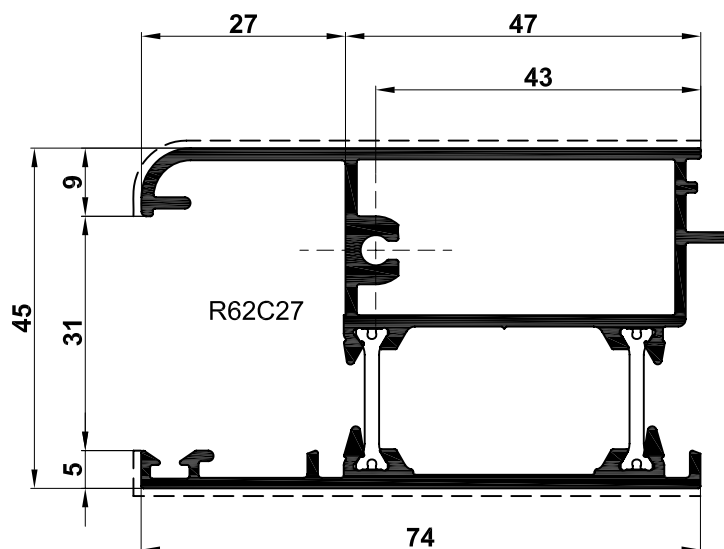
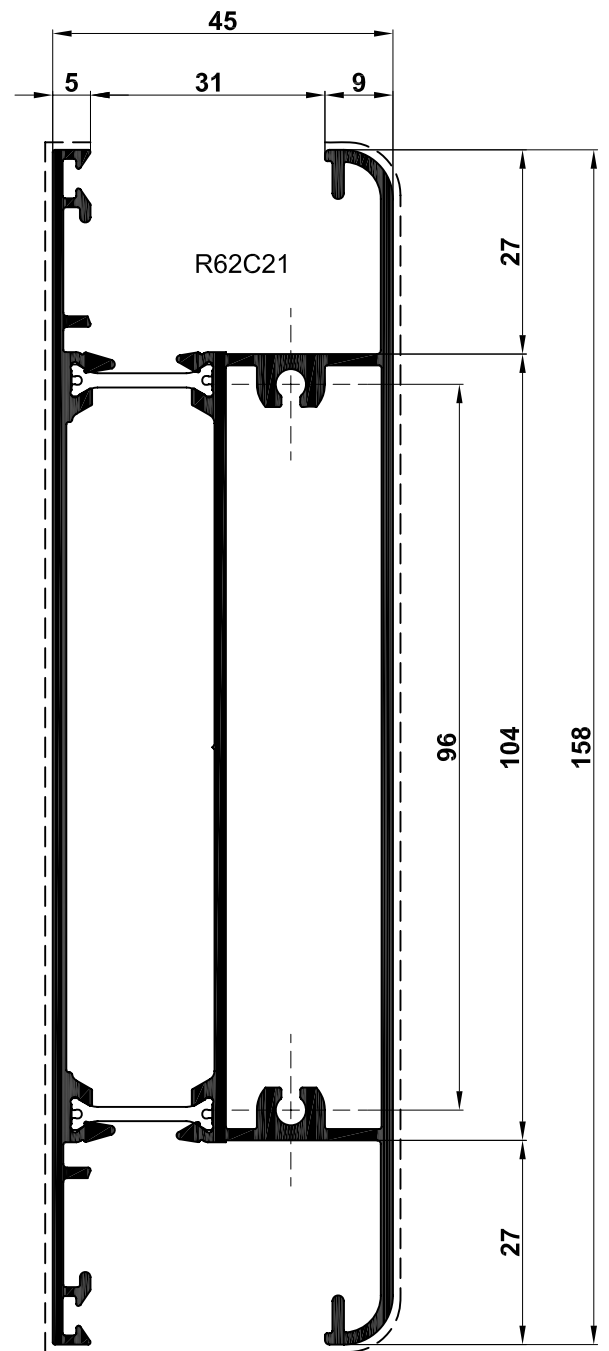
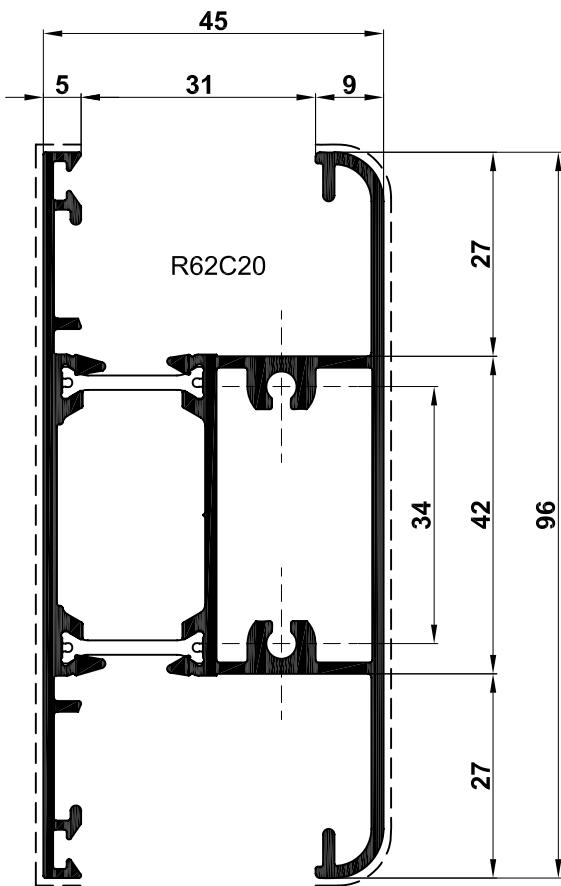

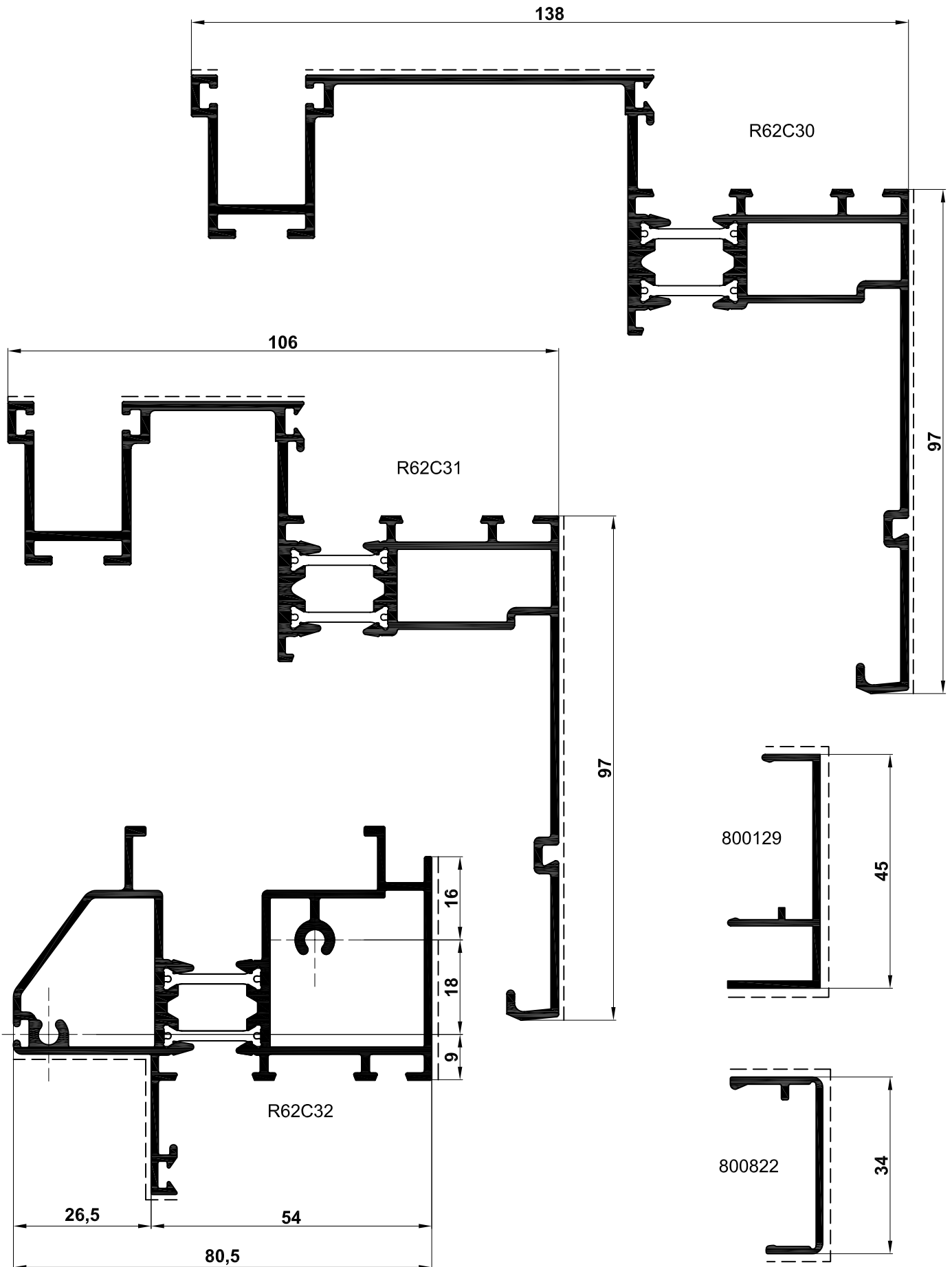

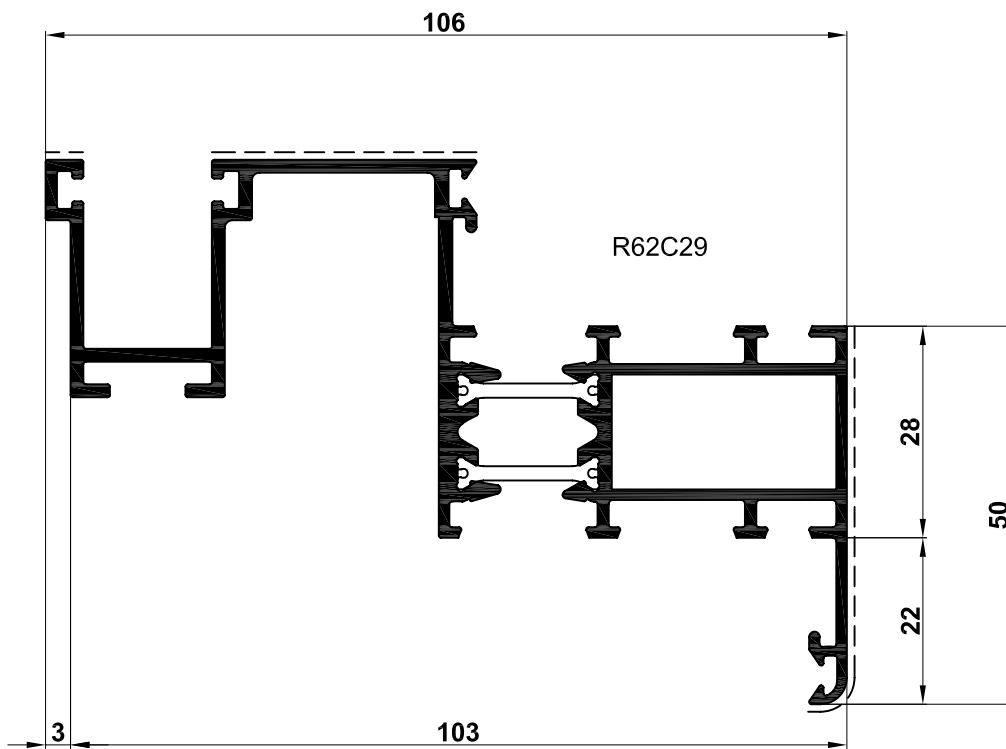
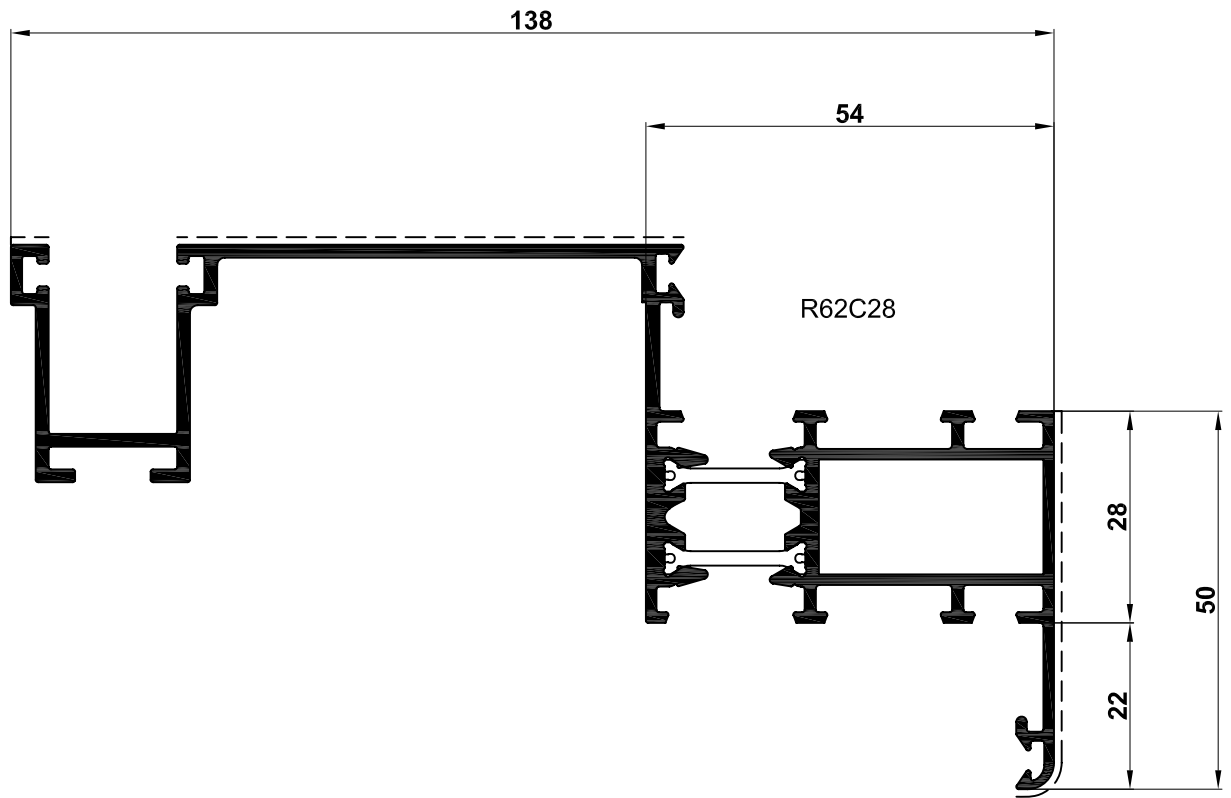

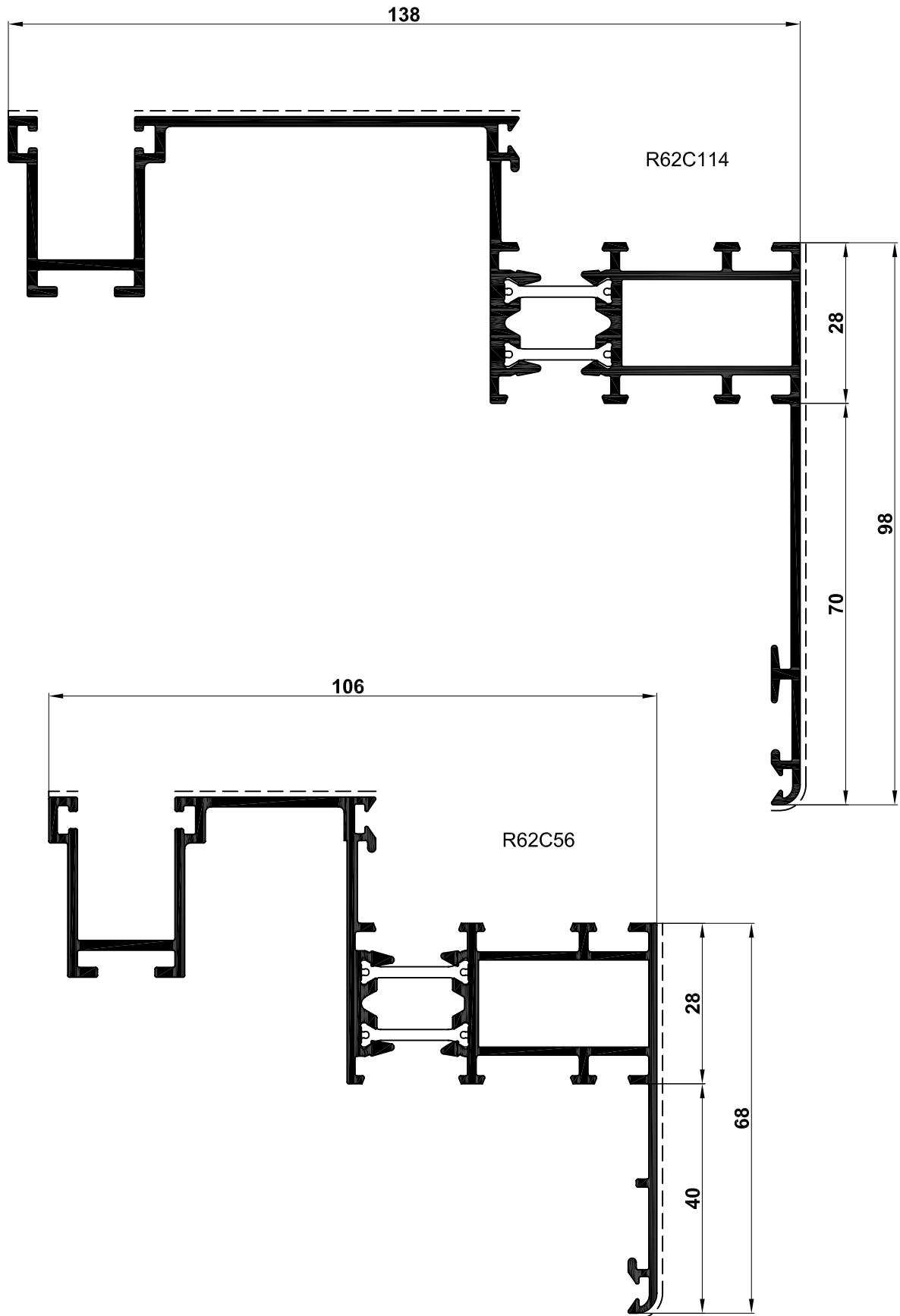

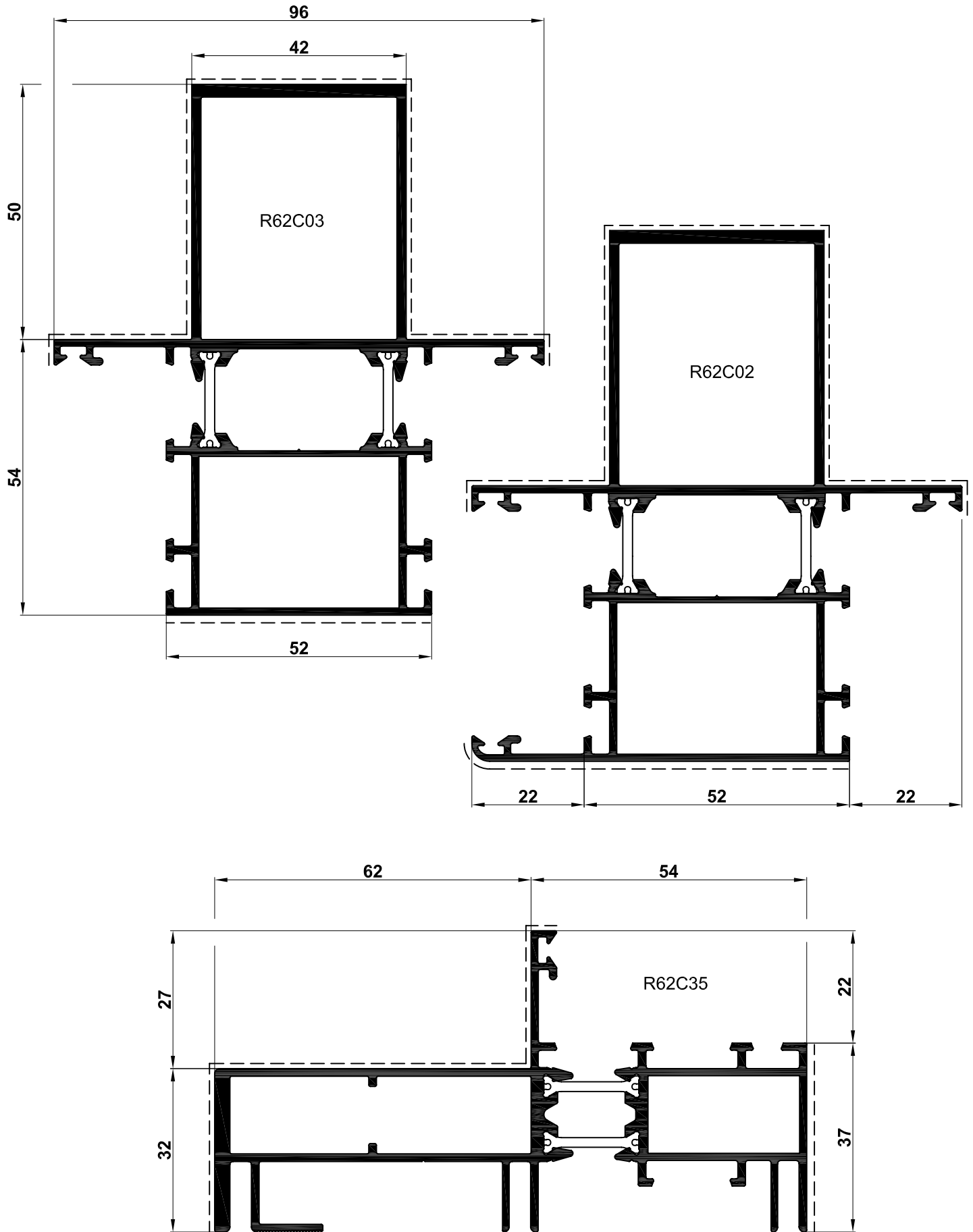

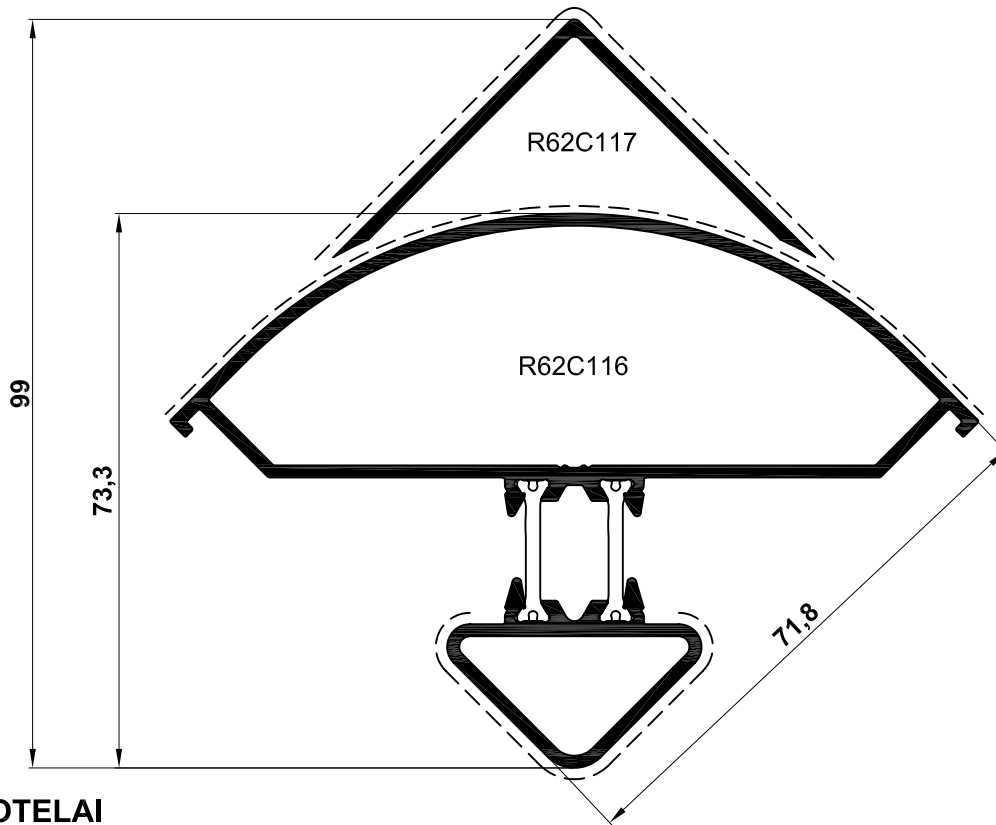

CONTROTELAI
COUNTER FRAMES

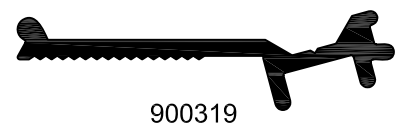
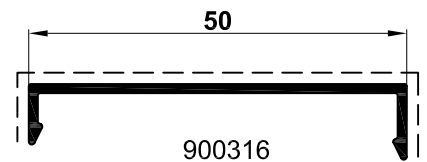
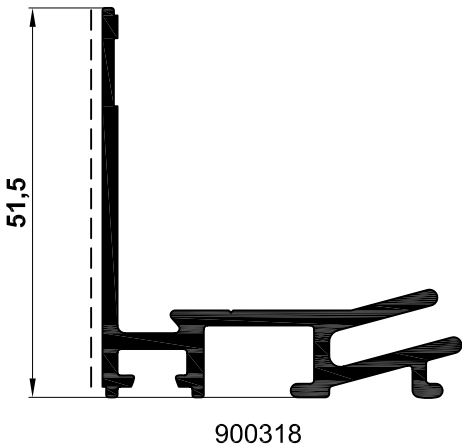
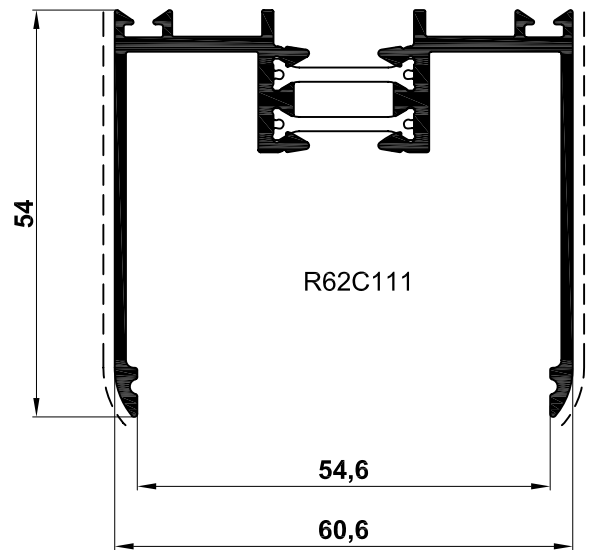
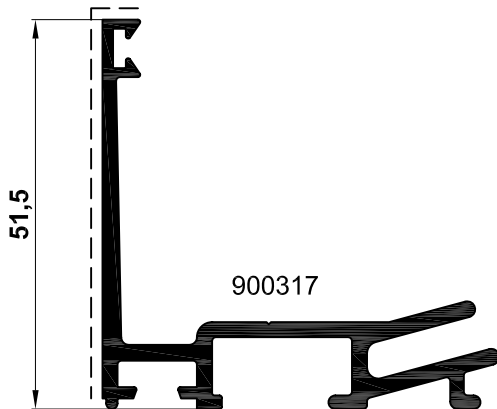

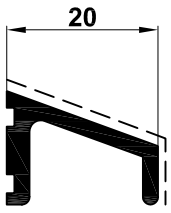

100009

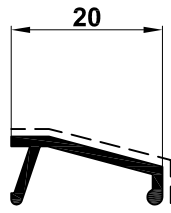

100342

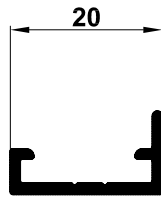

1F14042

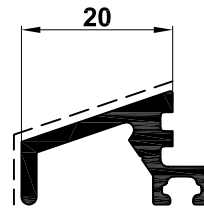

900390

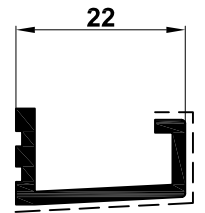

900424

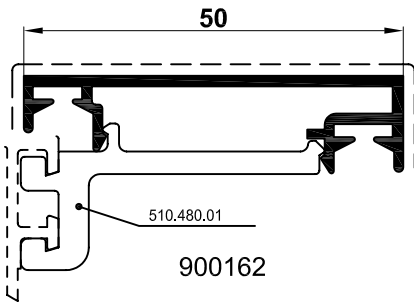

900162

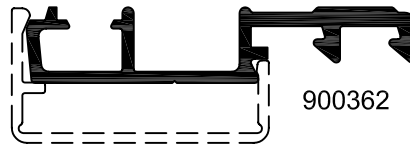

800822

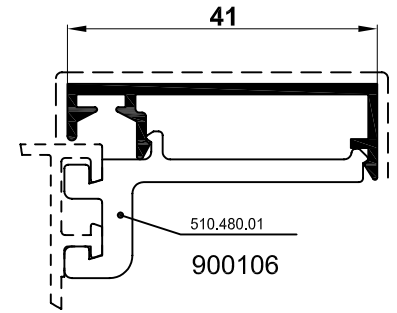

900106

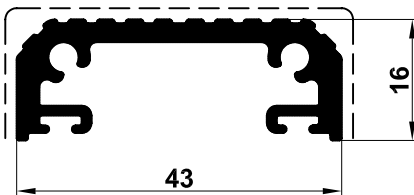

1F14041

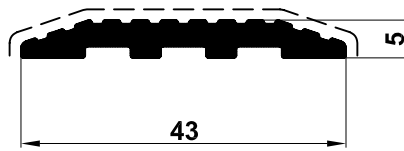

1F14039

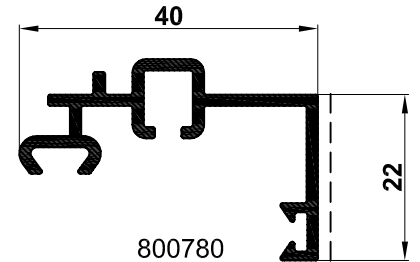

800780

**DOGA
STAVE**

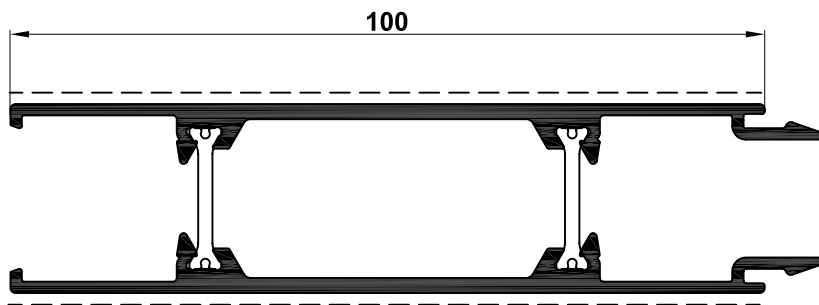

R62C157

**ASTA
BAR**



900221

Peso Kg/ml 0.167
Perimetro mm 57
Lunghezza Standard Barre = 6500 mm
Standard length = 6500 mm

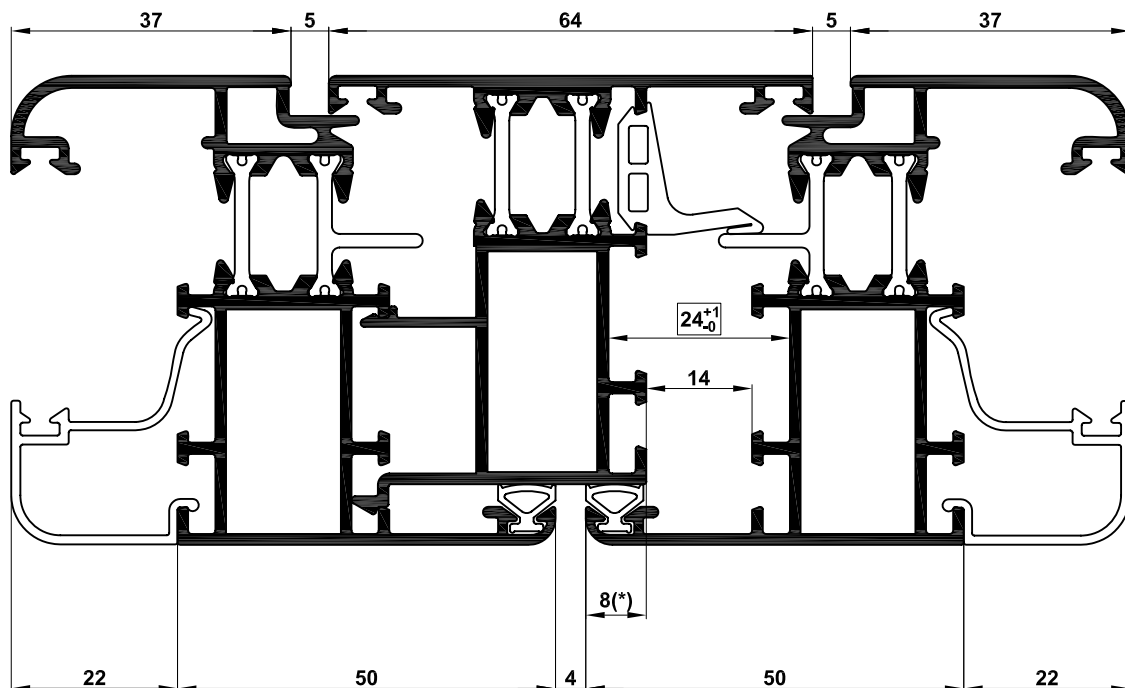
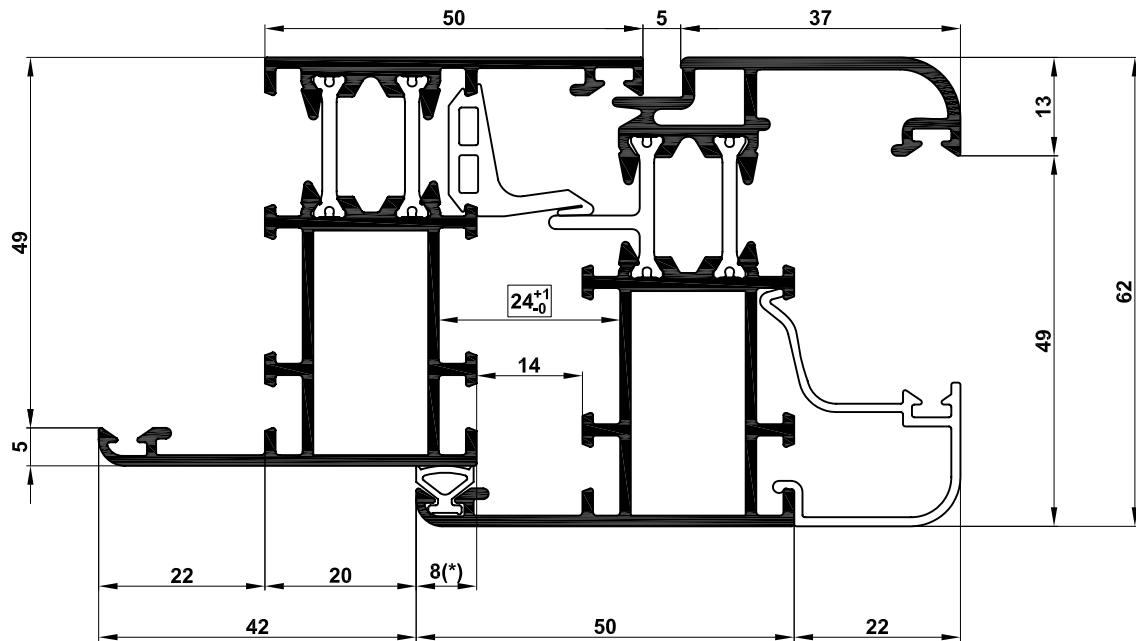

Dimensione Minima Larghezza Anta 500mm

Nel caso si debbano realizzare ante aventi dimensioni ridotte (vedi nota riportata) si consiglia di diminuire la quota di battuta da 8 mm a 7,5 mm

N.B.:

- Le dimensioni indicate sono state ottenute considerando le quote teoriche.

Minimum wing width 500mm

In case you need to realize small wings (see note). We suggest to decrease the closure dimension from 8mm to 7,5mm

N.B.:

- The dimensions indicated, are obtained considering theoretical values.

- Sezioni tipiche finestra, porta a battente e anta ribalta.
Typical sections of window, door and tilt and turn.

- Per distinte di taglio e inserimento accessori, tenere presente questo schema
Take this diagram into consideration for cut and accessories

*Per anta ribalta "Rbalta 150", considerare 7,5 mm
For "Rbalta 150" tilt and turn, have to consider 7,5 mm

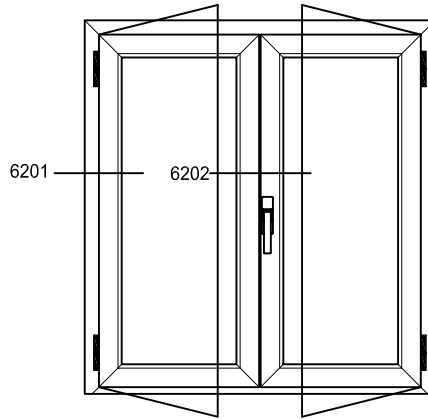

(*) Negli angoli a 45° le squadrette inserite nel tubolare esterno devono essere sempre incollate e cianfrinate. Cianfrinatura eseguibile anche con attrezzatura manuale Cod. M.2001.00
In the 45° corners, the corner joints in the external tubular section, must always be glued and caulked. Caulking may also be carried out by hand with equipment Art.M.2001.00

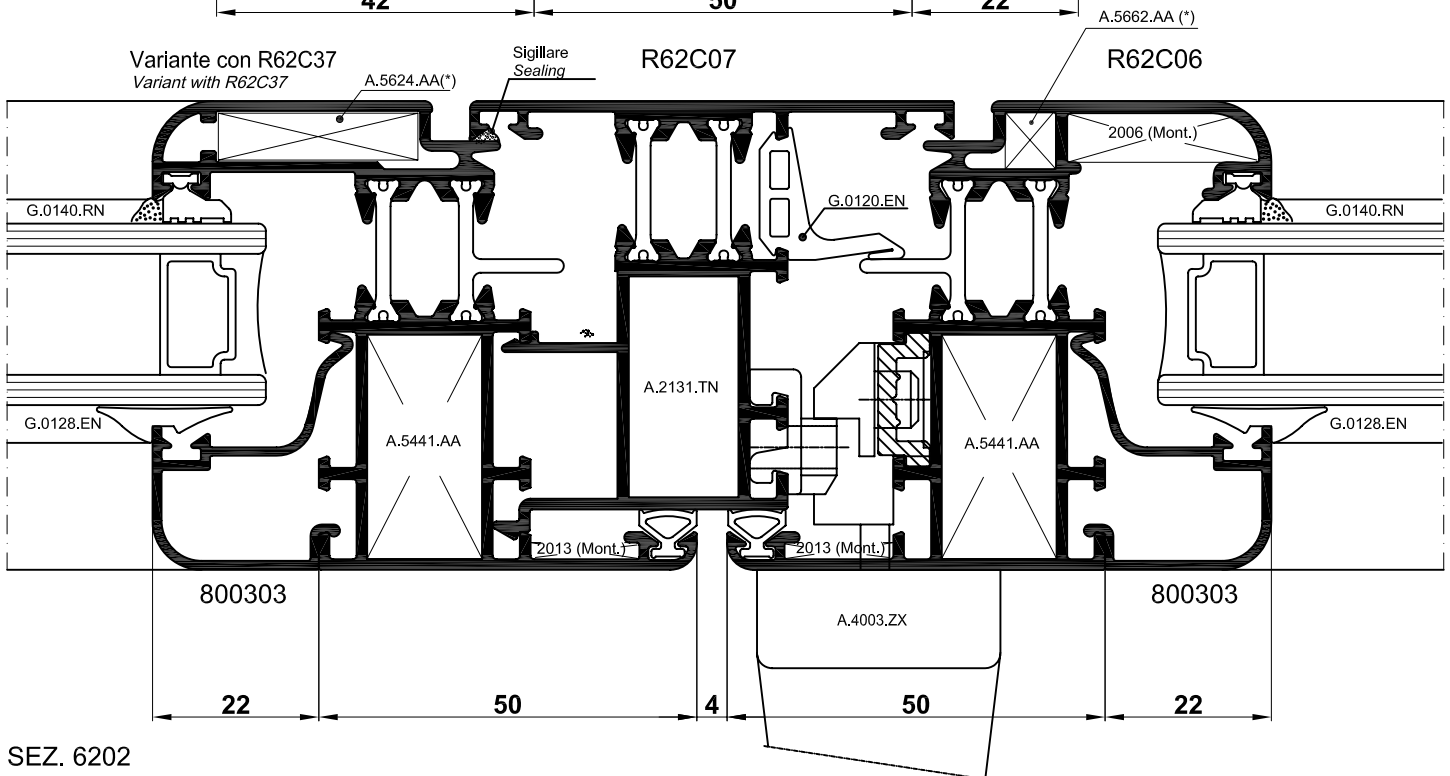
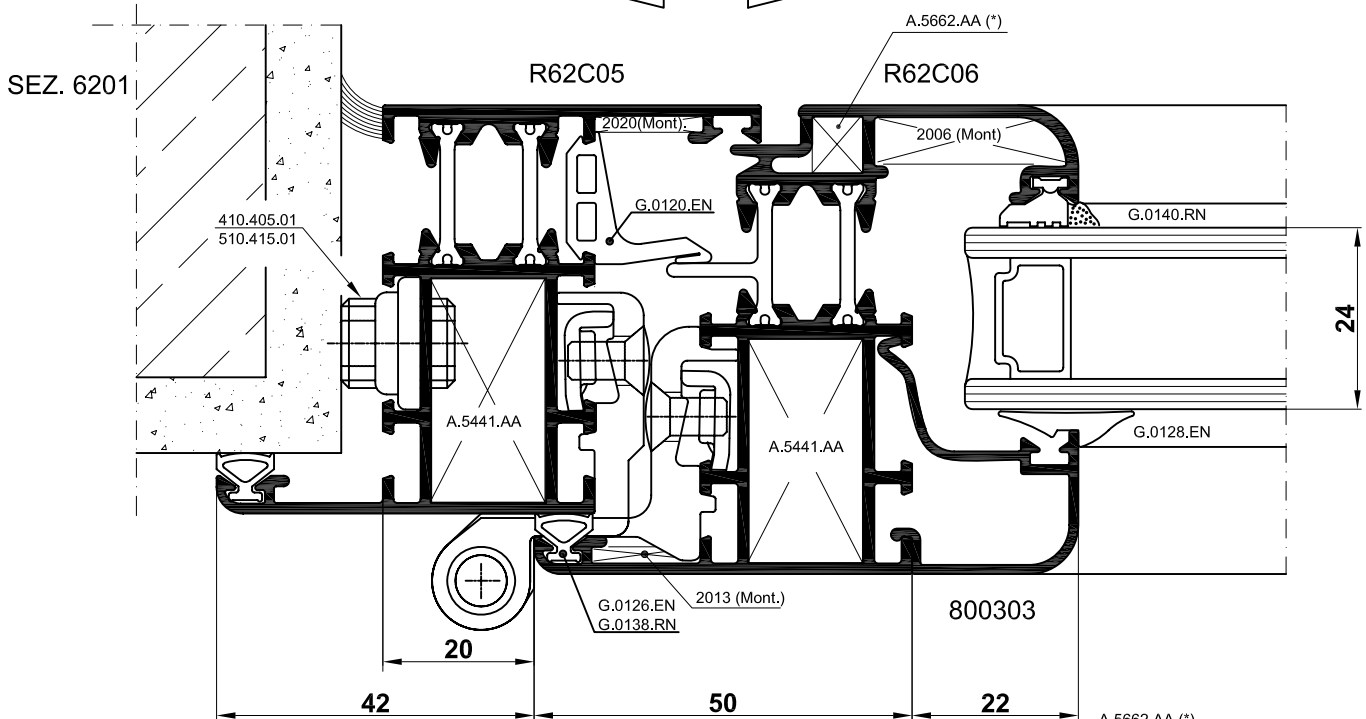

SEZ. 6202

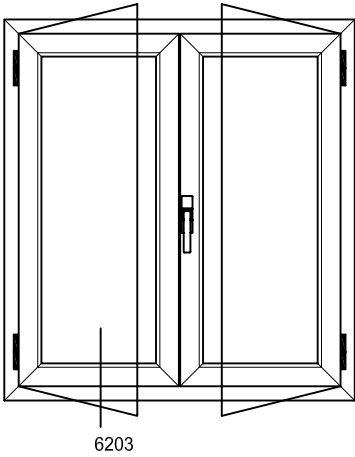

6203

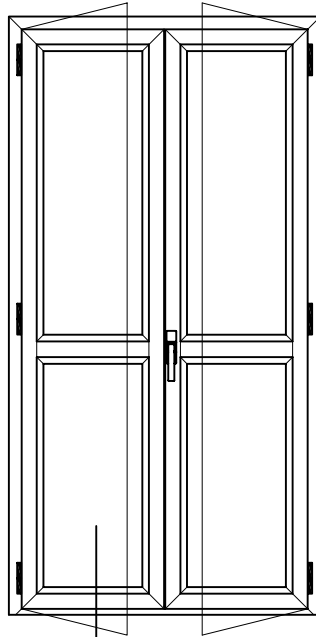

6204

(*) Negli angoli a 45° le squadrette inserite nel tubolare esterno devono essere sempre incollate e cianfrinate.
 Cianfrinatura eseguibile anche con attrezzatura manuale Cod. M.2001.OO
In the 45° corners, the corner joints in the external tubular section, must always be glued and caulked. Caulking may also be carried out by hand with equipment Art.M.2001.OO

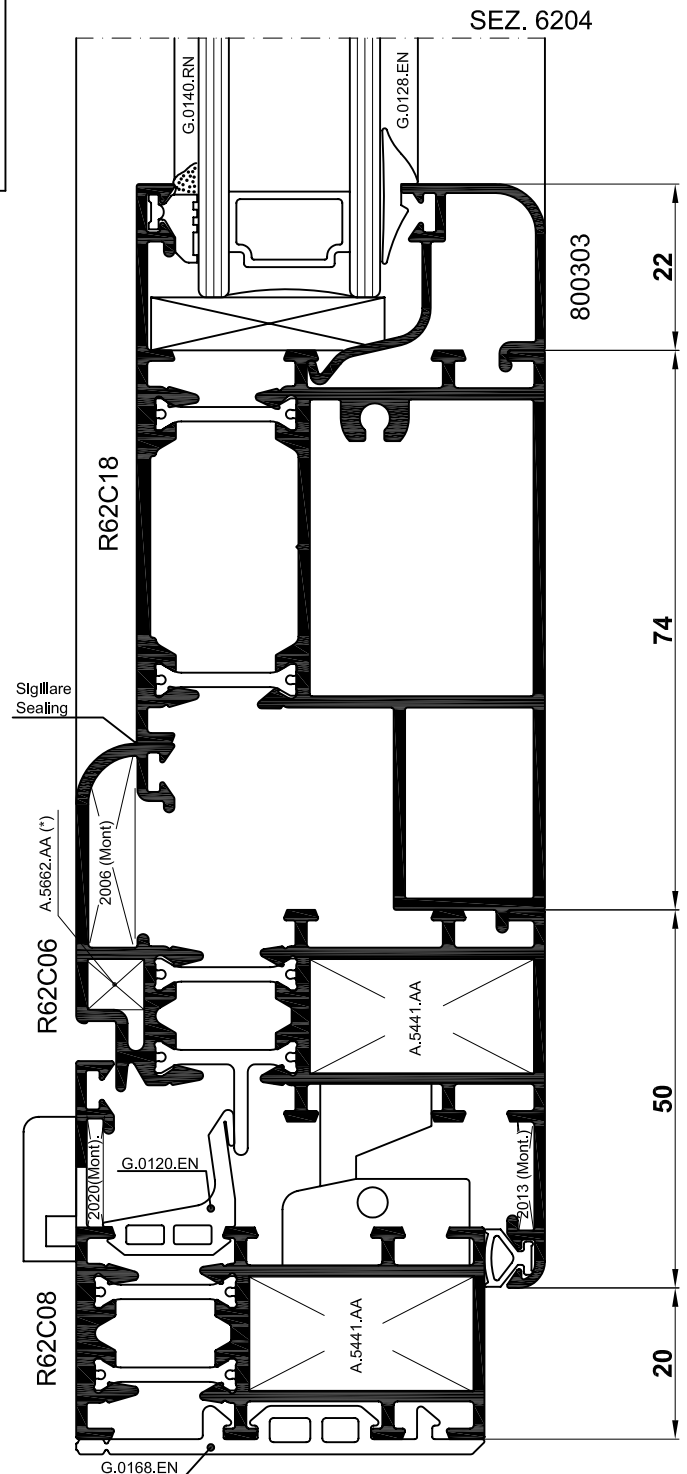
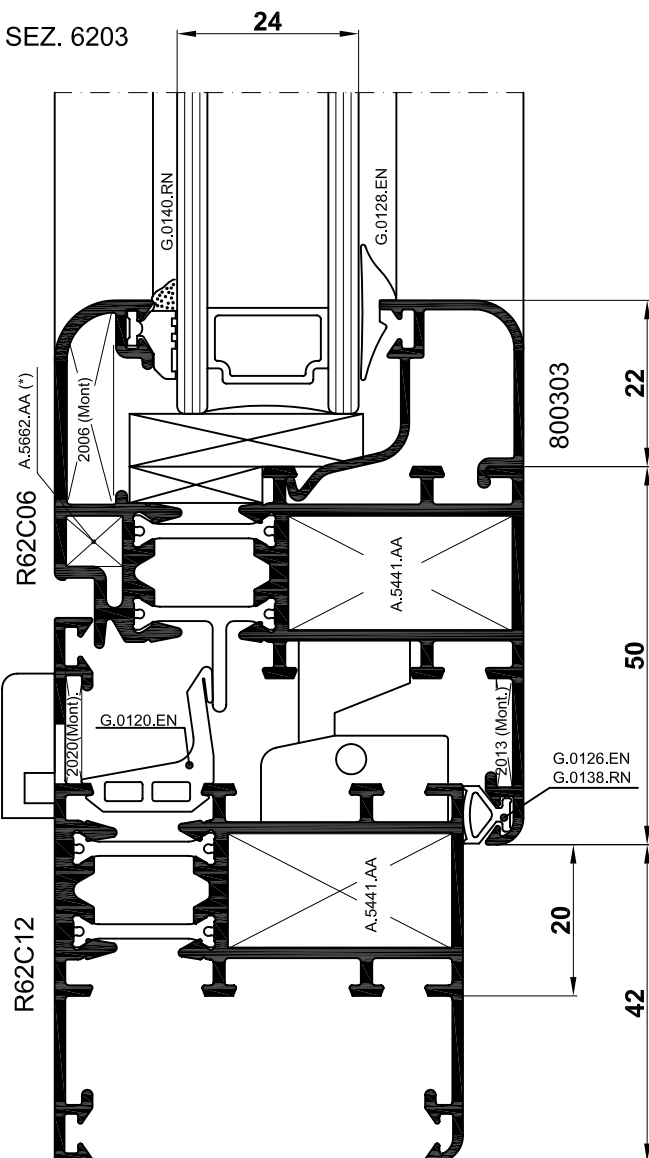

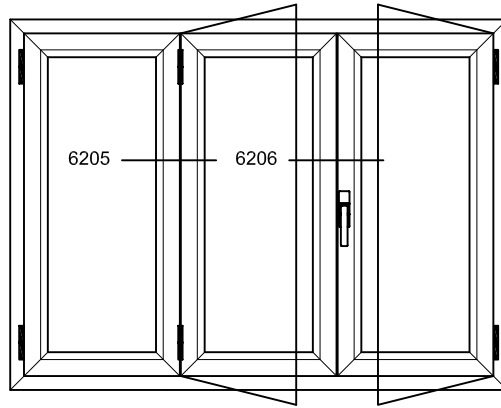

(*) Negli angoli a 45° le squadrette inserite nel tubolare esterno devono essere sempre incollate e cianfrinate. Cianfrinatura eseguibile anche con attrezzatura manuale Cod. M.2001.OO
In the 45° corners, the corner joints in the external tubular section, must always be glued and caulked. Caulking may also be carried out by hand with equipment Art.M.2001.OO

SEZ. 6206

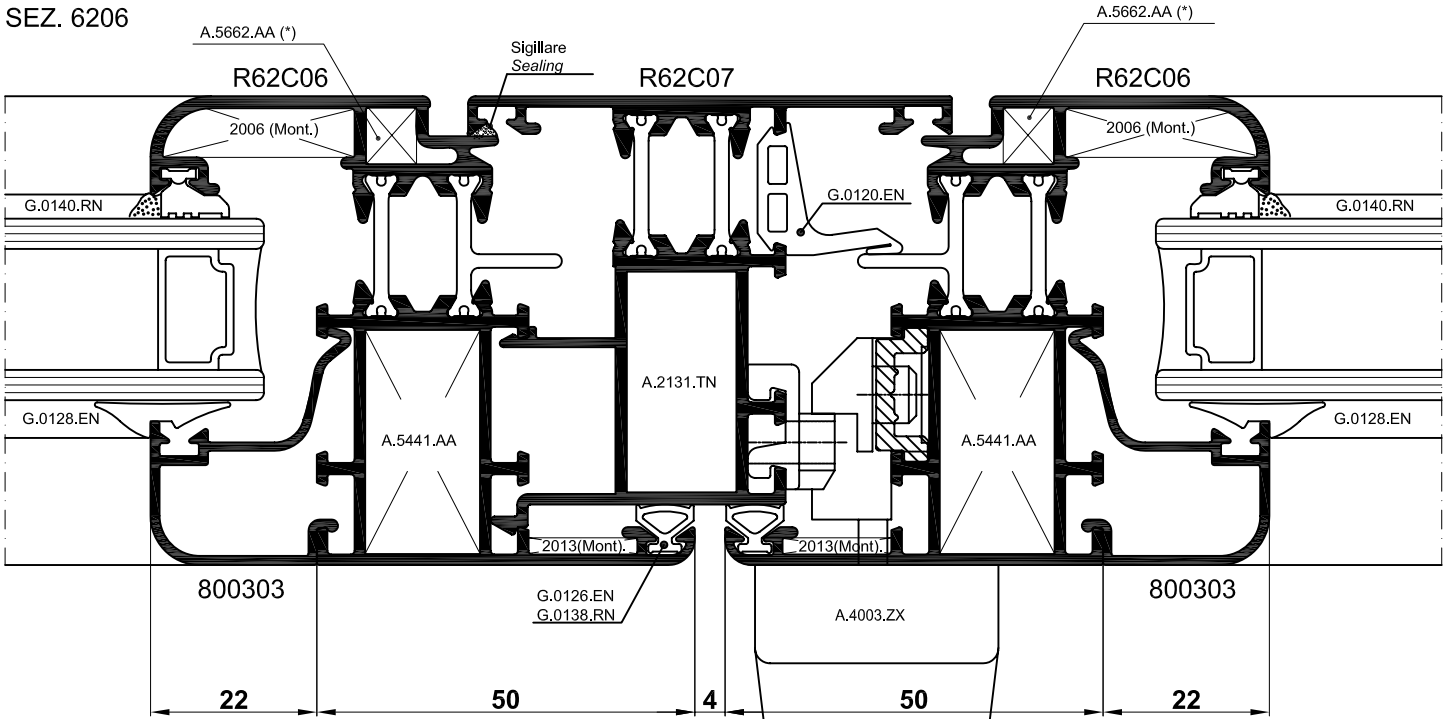

SEZ. 6205

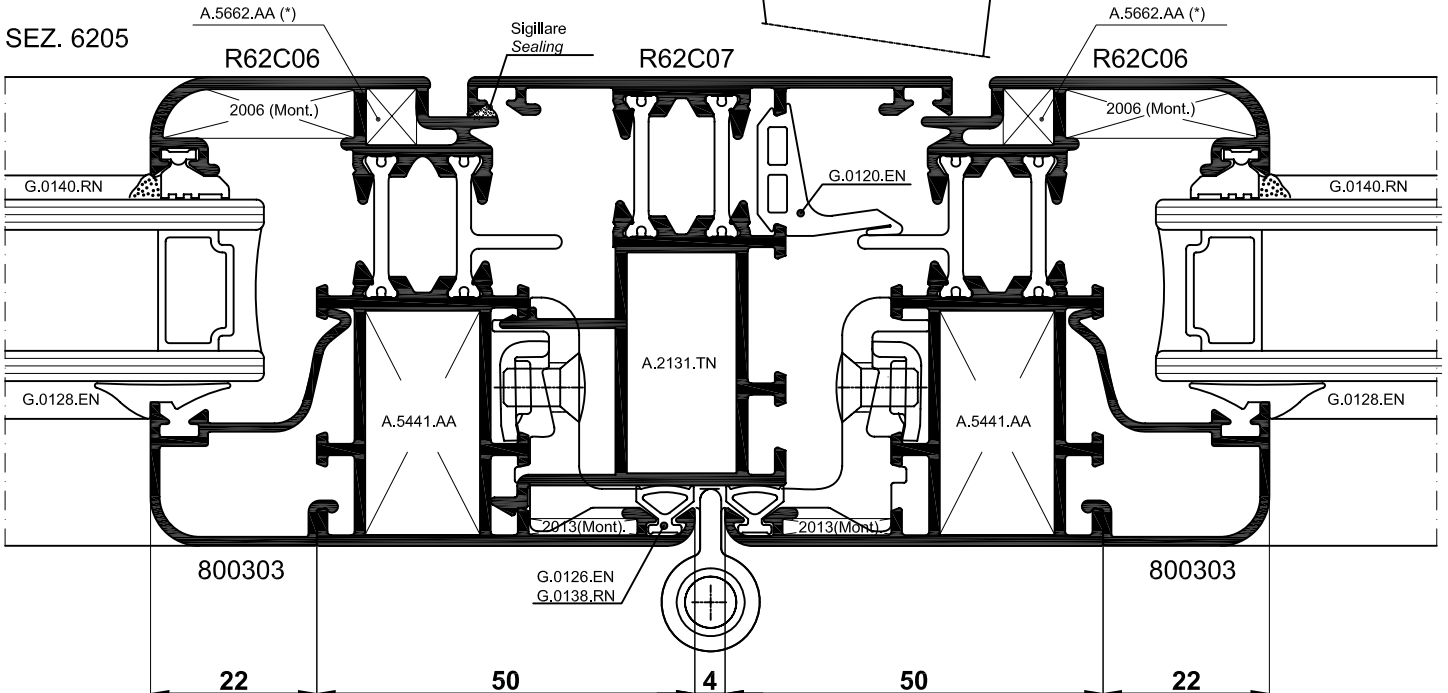

SEZIONI - FINESTRA A DUE ANTE - SOLUZIONE ARROTONDATA
SECTIONS - TWO WING WINDOW - ROUNDED SOLUTION

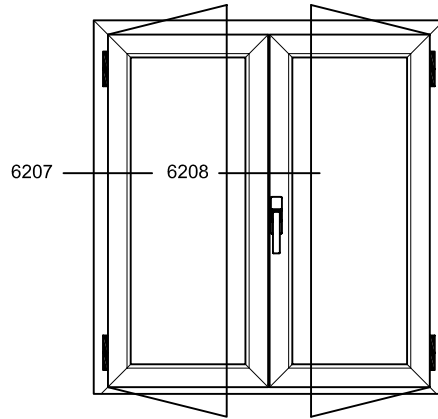

(*) Negli angoli a 45° le squadrette inserite nel tubolare esterno devono essere sempre incollate e cianfrinate. Cianfrinatura eseguibile anche con attrezzatura manuale Cod. M.2001.OO
In the 45° corners, the corner joints in the external tubular section, must always be glued and caulked. Caulking may also be carried out by hand with equipment Art.M.2001.OO

SEZ. 6207

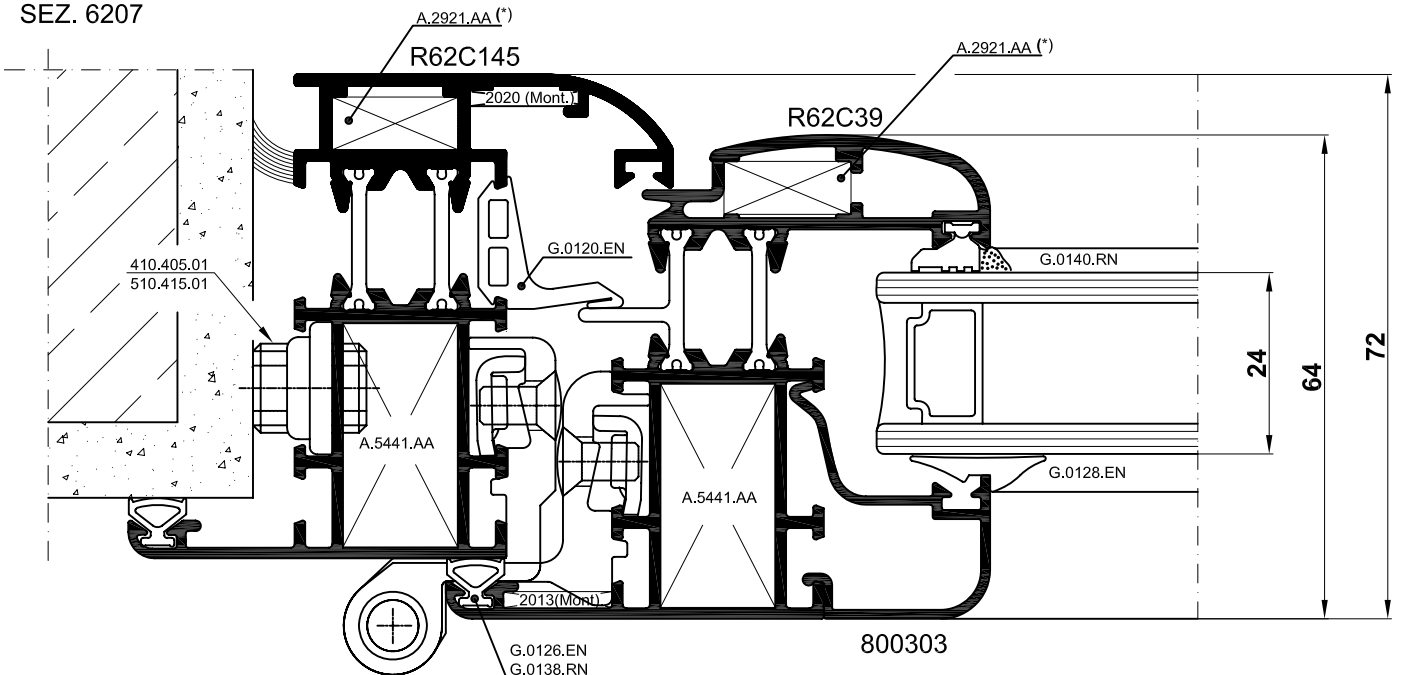

SEZ. 6208

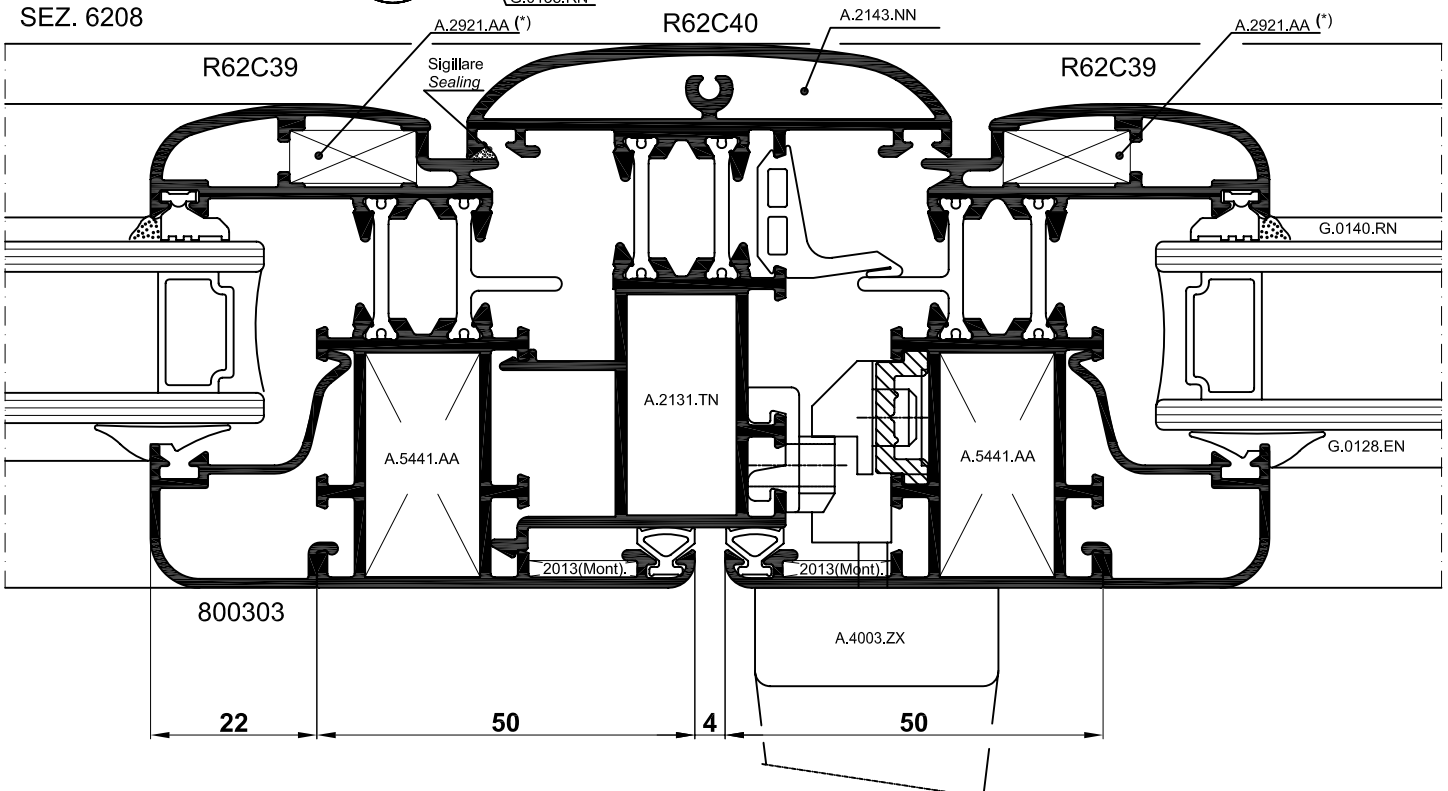

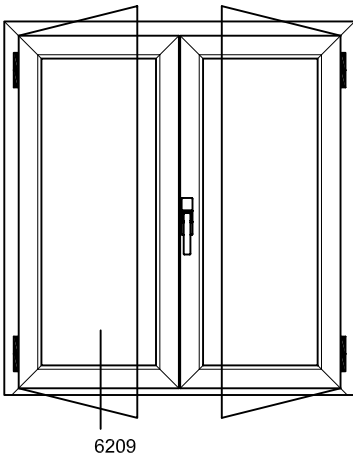

6209

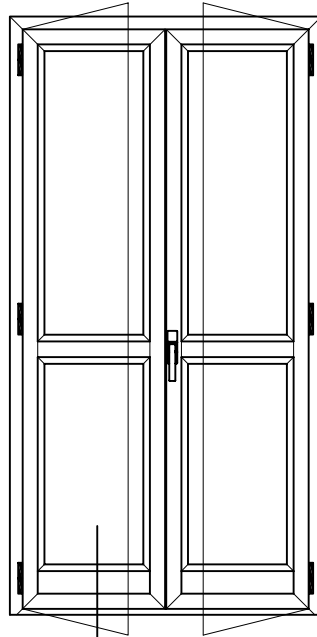

6210

(*) Negli angoli a 45° le squadrette inserite nel tubolare esterno devono essere sempre incollate e cianfrinate.
 Cianfrinatura eseguibile anche con attrezzatura manuale Cod. M.2001.OO
 In the 45° corners, the corner joints in the external tubular section, must always be glued and caulked.
 Caulking may also be carried out by hand with equipment Art.M.2001.OO

SEZ. 6210

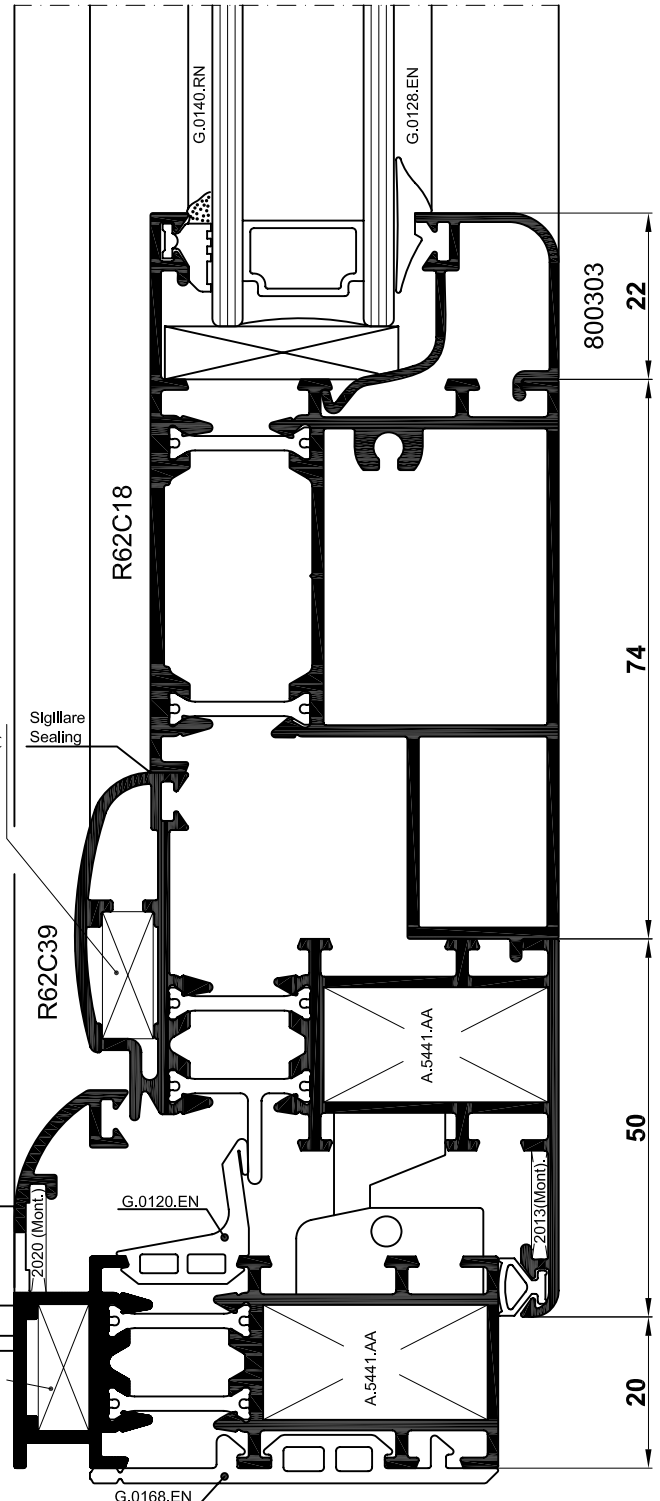

SEZ. 6209

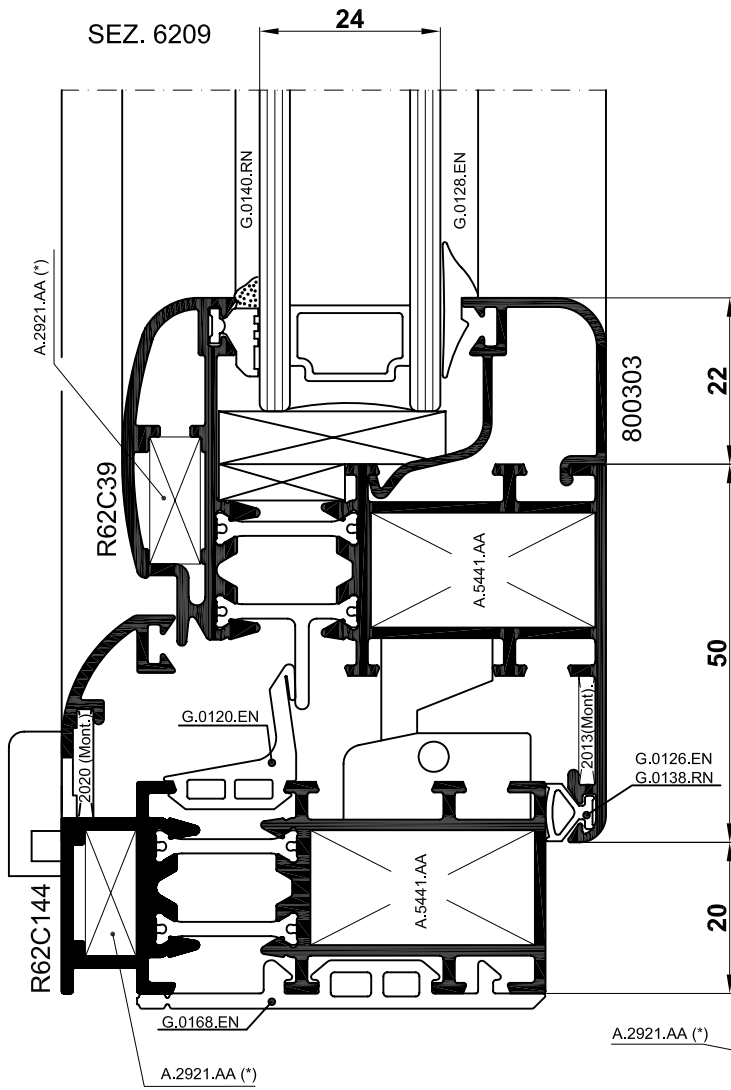

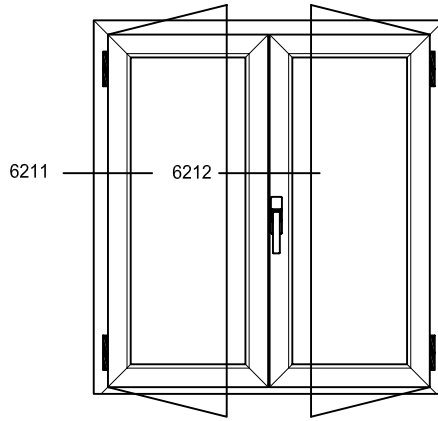

(*) Negli angoli a 45° le squadrette inserite nel tubolare esterno devono essere sempre incollate e cianfrinate. Cianfrinatura eseguibile anche con attrezzatura manuale Cod. M.2001.OO
In the 45° corners, the corner joints in the external tubular section, must always be glued and caulked. Caulking may also be carried out by hand with equipment Art.M.2001.OO

SEZ. 6211

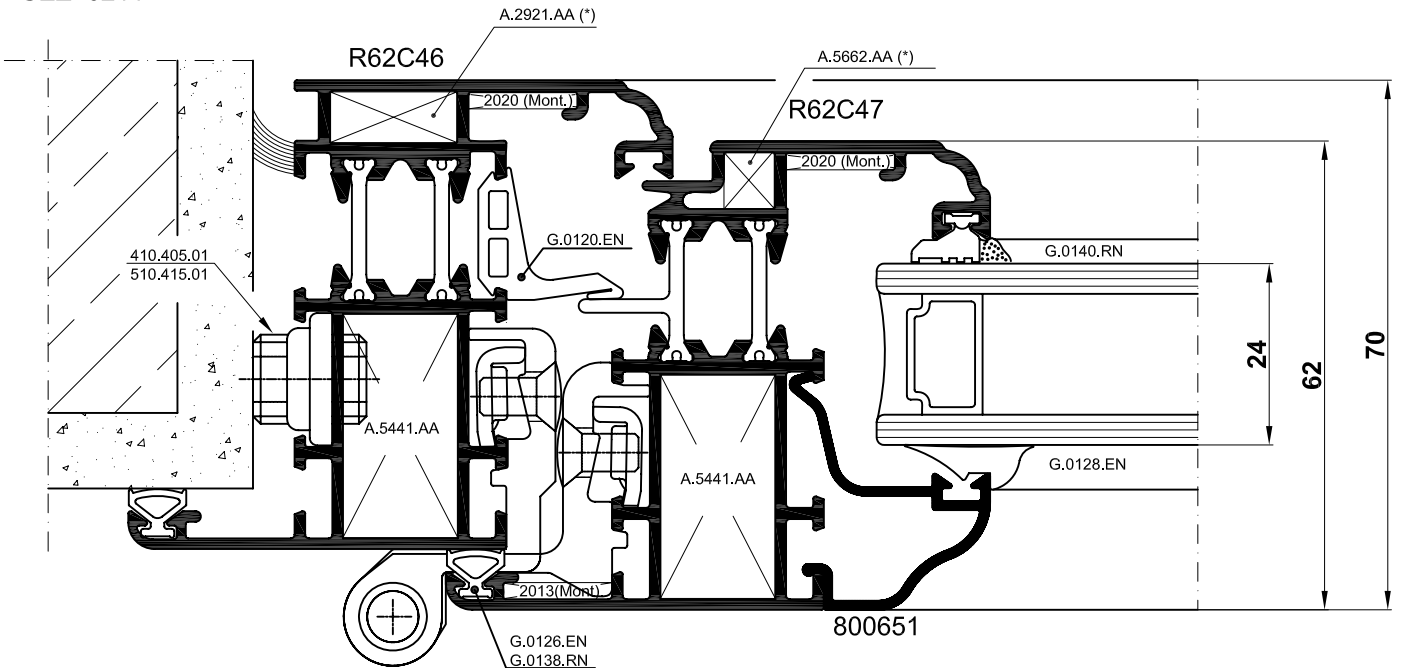

SEZ. 6212

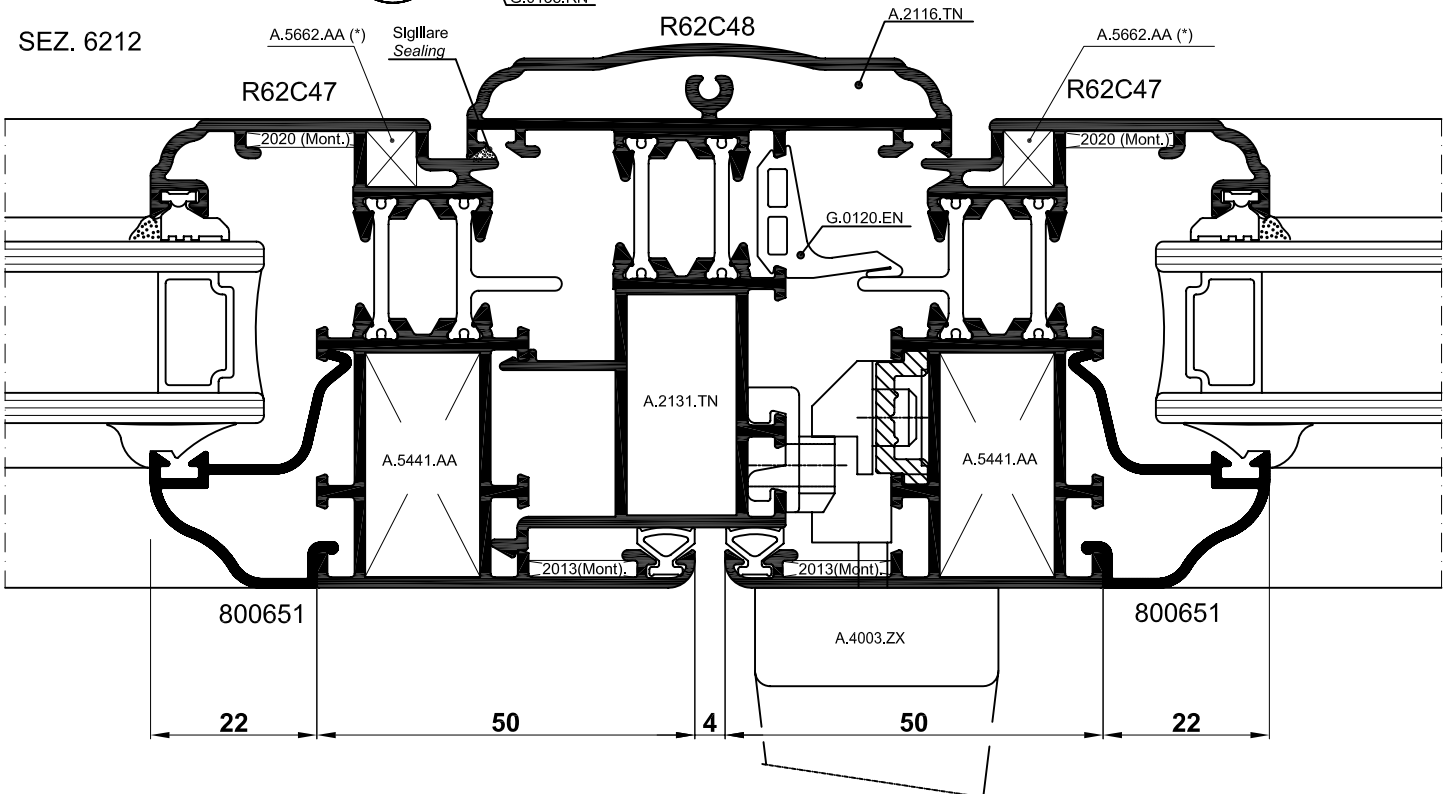

(*) Negli angoli a 45° le squadrette inserite nel tubolare esterno devono essere sempre incollate e cianfrinate. Cianfrinatura eseguibile anche con attrezzatura manuale Cod. M.2001.OO
In the 45° corners, the corner joints in the external tubular section, must always be glued and caulked. Caulking may also be carried out by hand with equipment Art.M.2001.OO

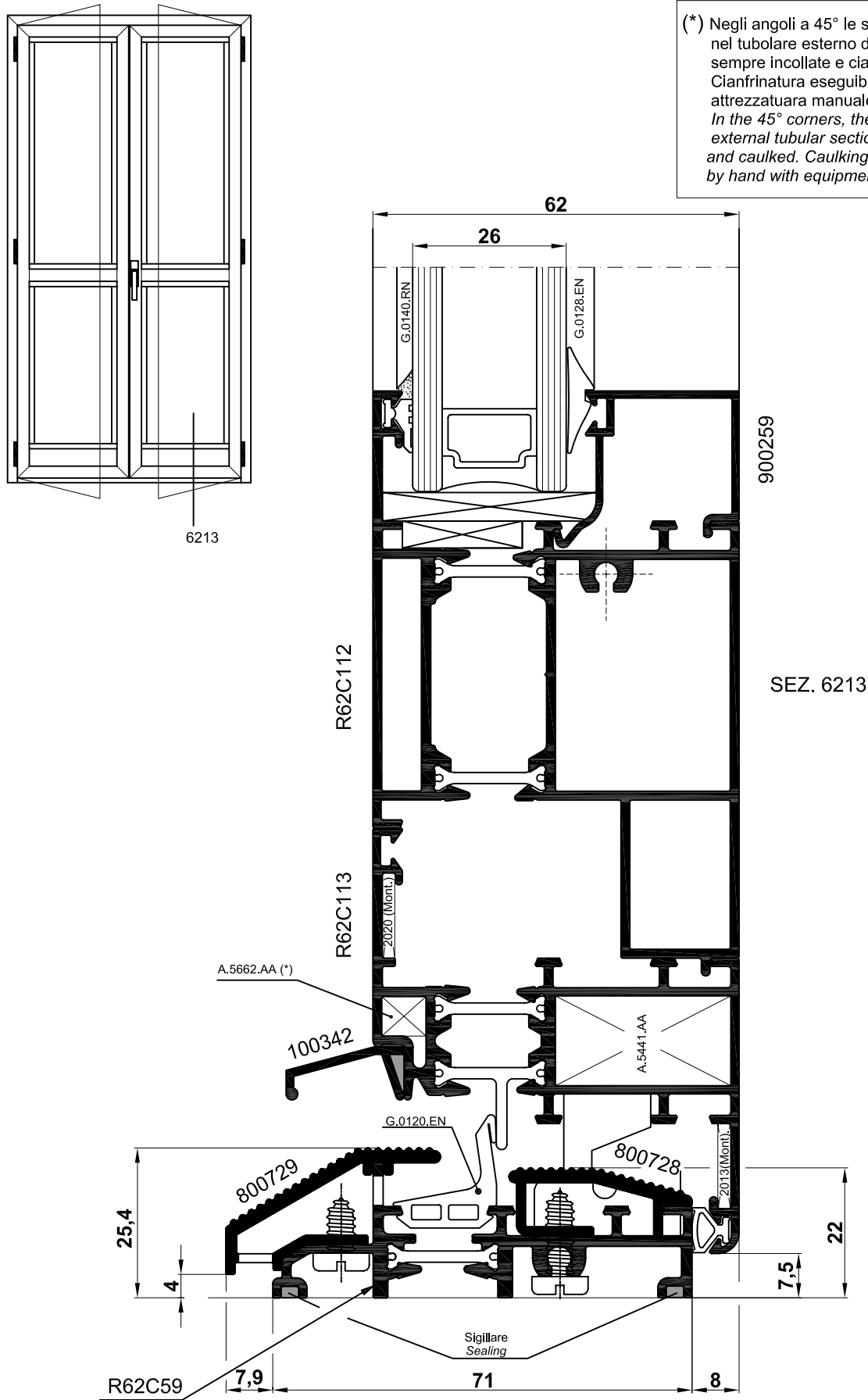

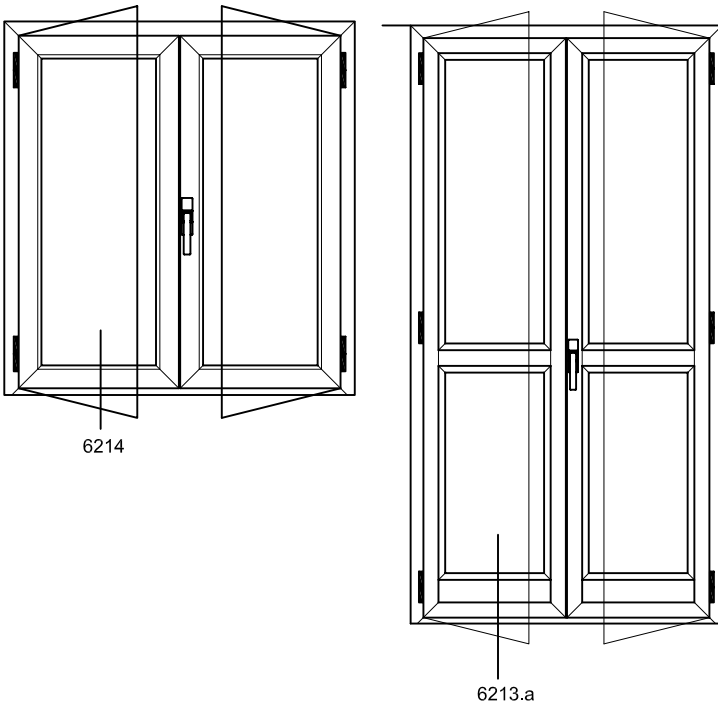

(*) Negli angoli a 45° le squadrette inserite nel tubolare esterno devono essere sempre incollate e cianfrinate. Cianfrinatura eseguibile anche con attrezzatura manuale Cod. M.2001.00
 In the 45° corners, the corner joints in the external tubular section, must always be glued and caulked. Caulking may also be carried out by hand with equipment Art.M.2001.00

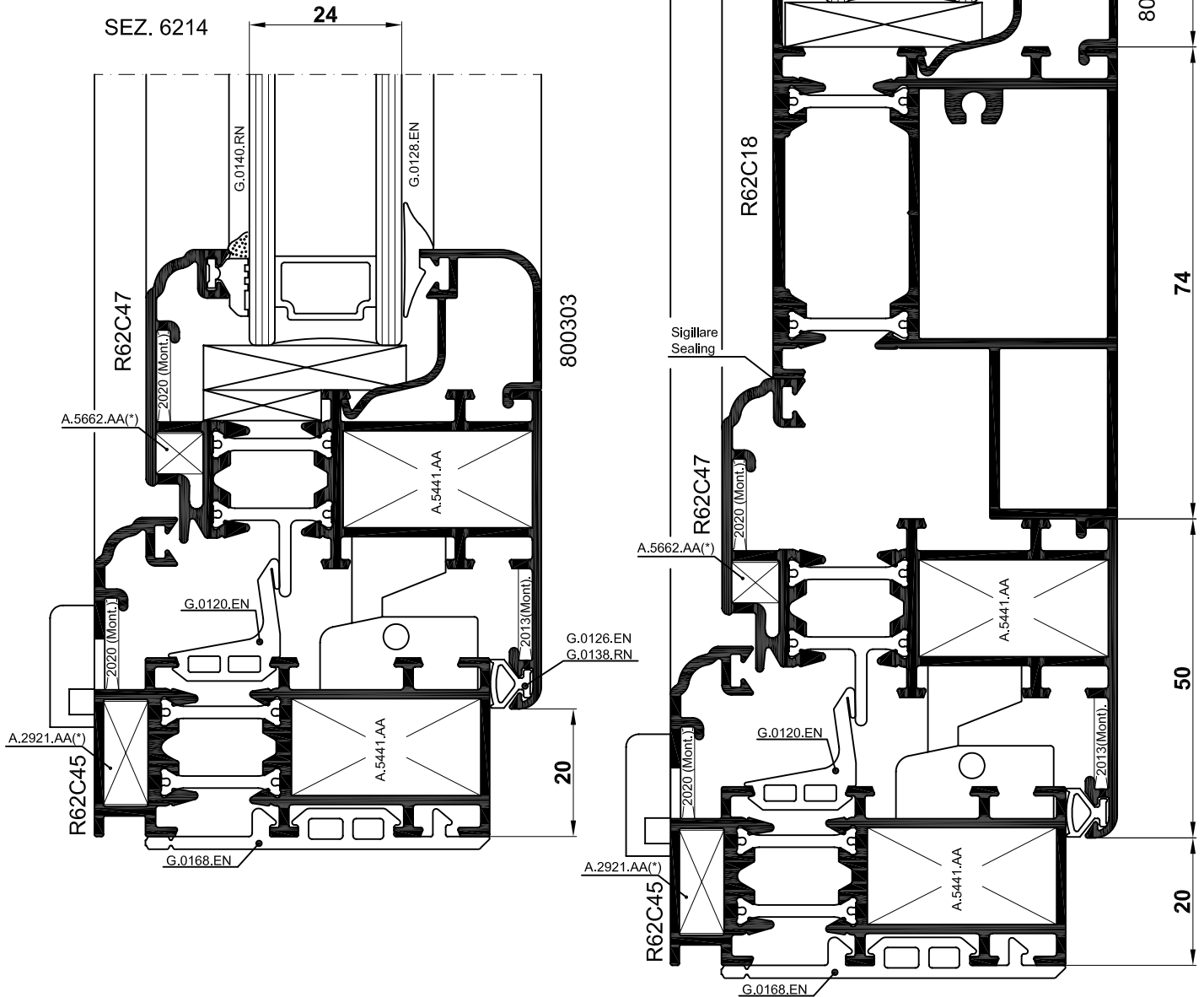

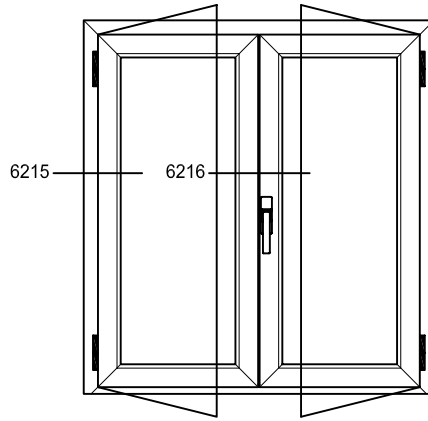

(*) Negli angoli a 45° le squadrette inserite nel tubolare esterno devono essere sempre incollate e cianfrinate.
 Cianfrinatura eseguibile anche con attrezzatura manuale Cod. M.2001.OO
 In the 45° corners, the corner joints in the external tubular section, must always be glued and caulked.
 Caulking may also be carried out by hand with equipment Art.M.2001.OO

SEZ. 6215

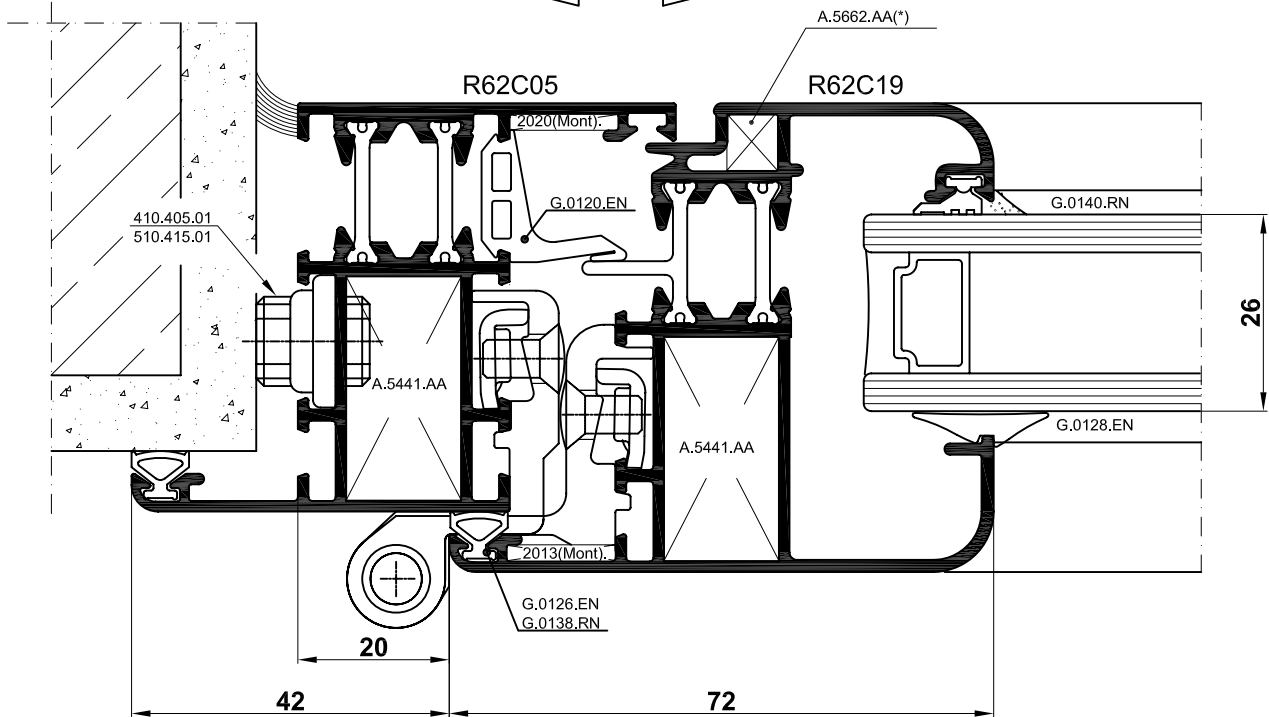

SEZ. 6216

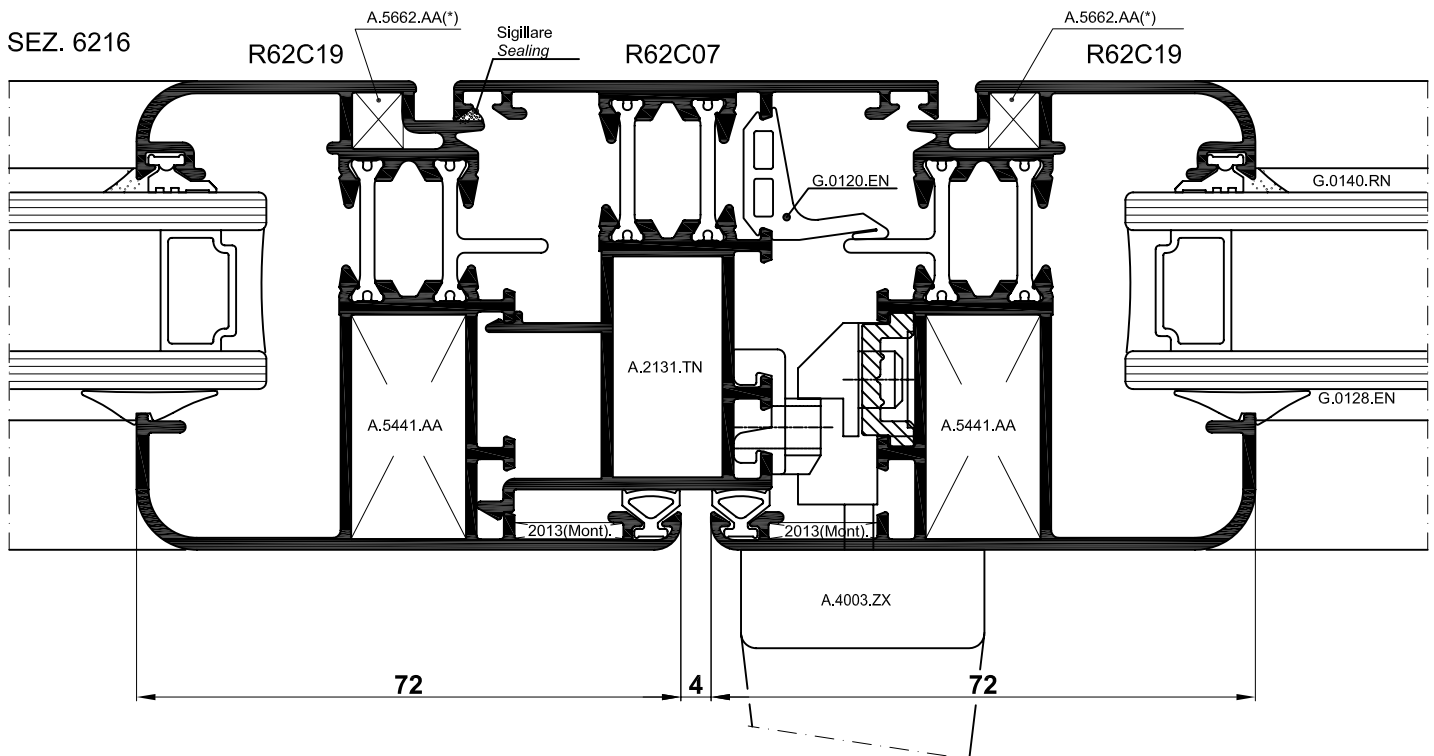

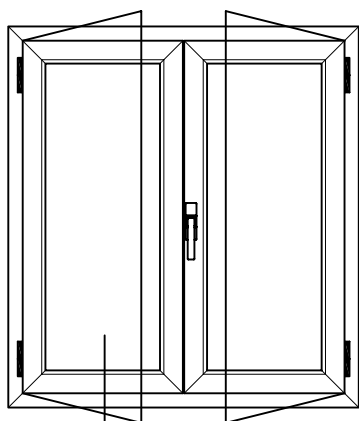

6217

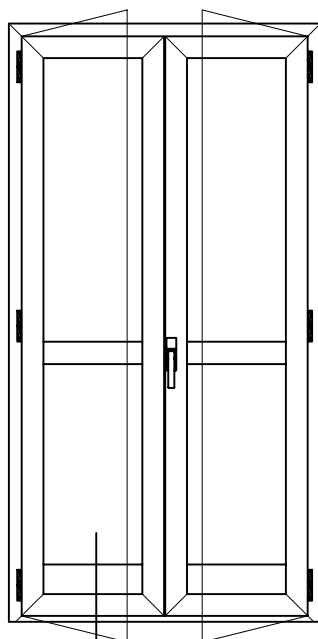

6218

(*) Negli angoli a 45° le squadrette inserite nel tubolare esterno devono essere sempre incollate e cianfrinate. Cianfrinatura eseguibile anche con attrezzatura manuale Cod. M.2001.OO
 In the 45° corners, the corner joints in the external tubular section, must always be glued and caulked. Caulking may also be carried out by hand with equipment Art.M.2001.OO

SEZ. 6218

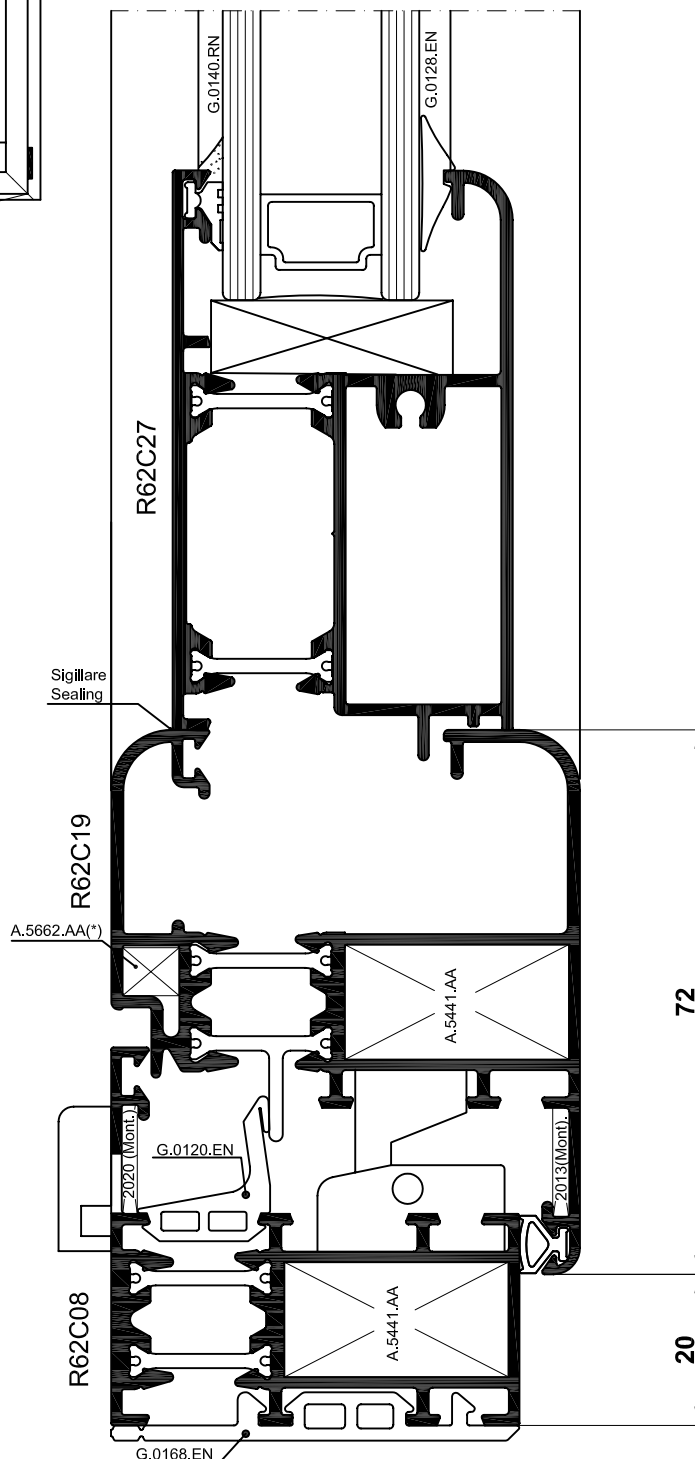
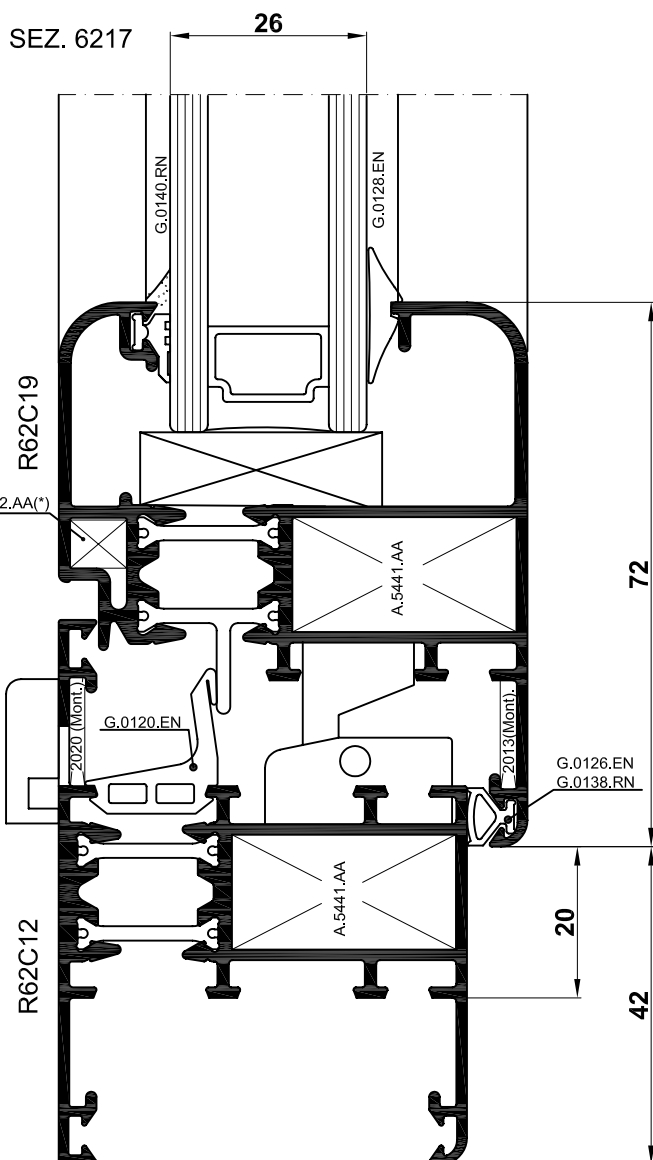

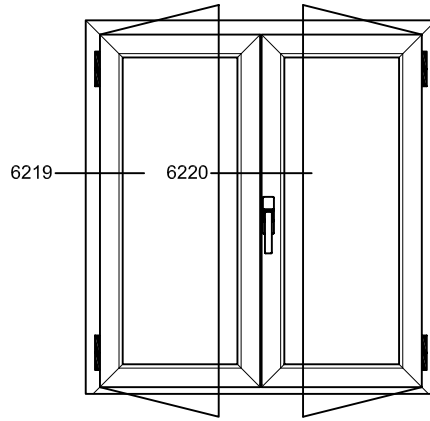

(*) Negli angoli a 45° le squadrette inserite nel tubolare esterno devono essere sempre incollate e cianfrinate.
 Cianfrinatura eseguibile anche con attrezzatura manuale Cod. M.2001.OO
In the 45° corners, the corner joints in the external tubular section, must always be glued and caulked. Caulking may also be carried out by hand with equipment Art.M.2001.OO

SEZ. 6219

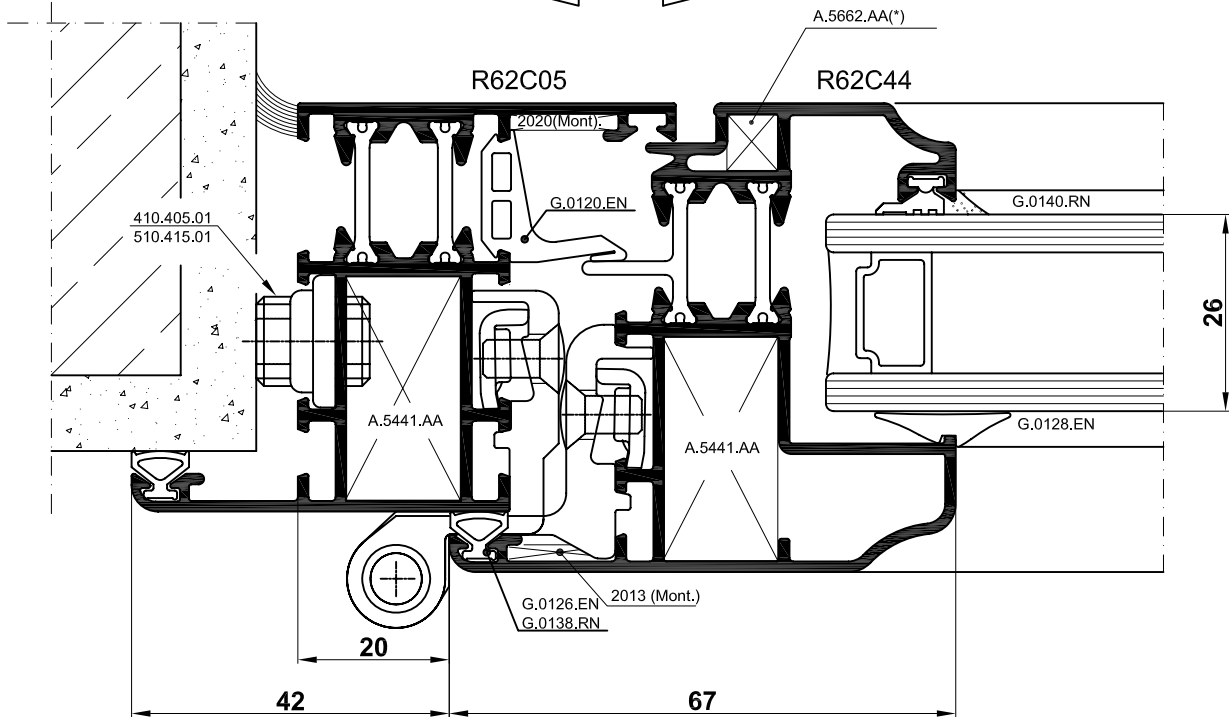

SEZ. 6220

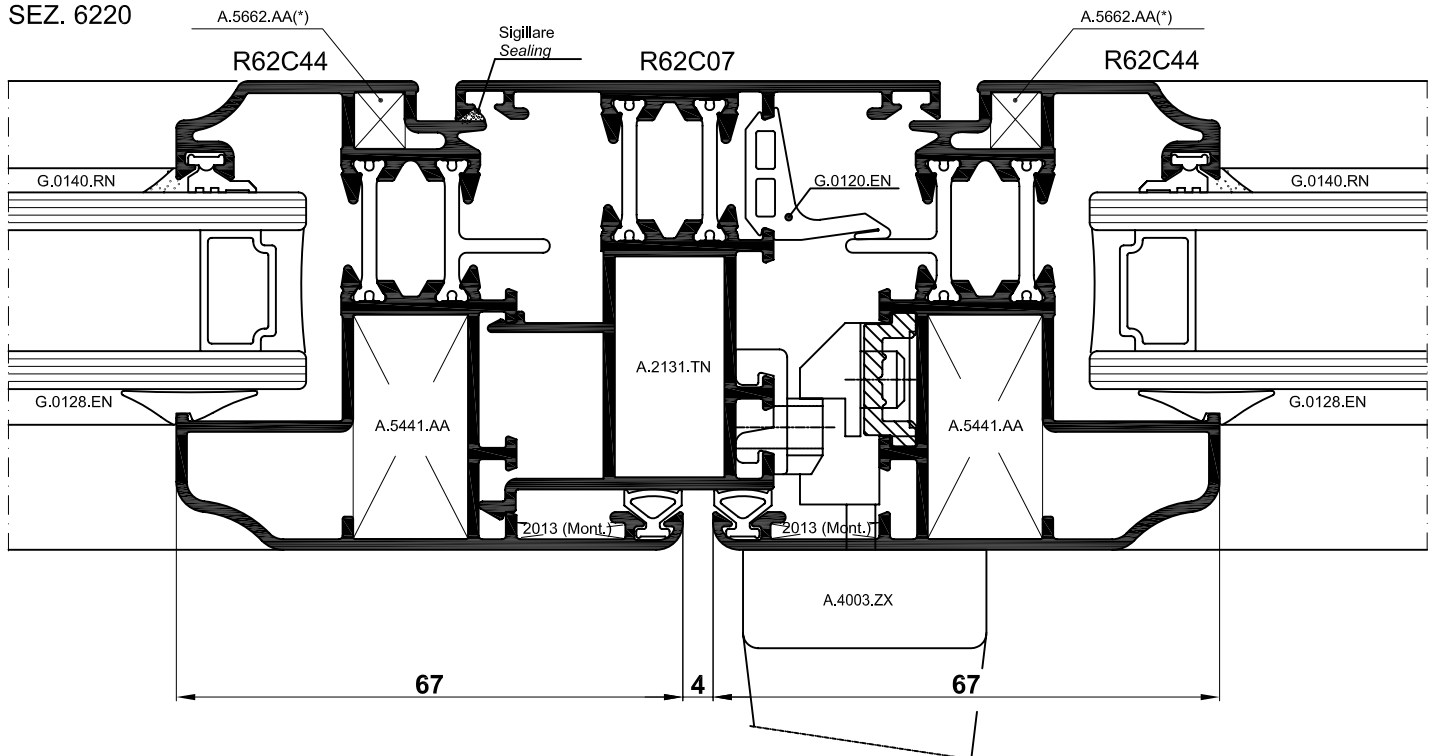

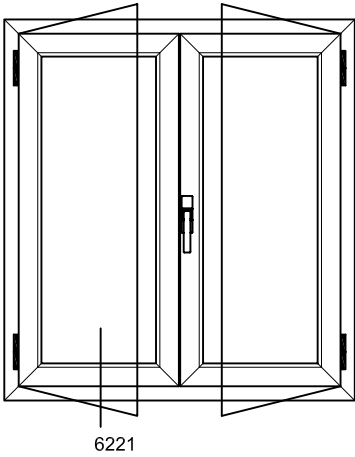

6221

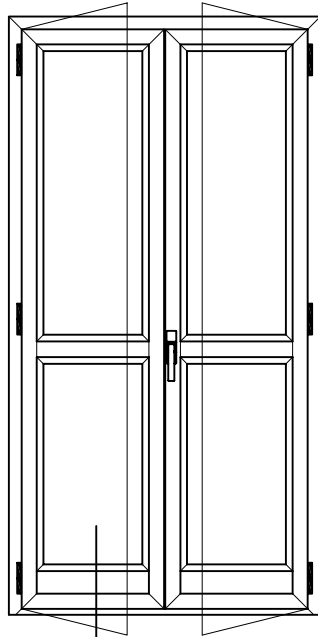

6222

(*) Negli angoli a 45° le squadrette inserite nel tubolare esterno devono essere sempre incollate e cianfrinate. Cianfrinatura eseguibile anche con attrezzatura manuale Cod. M.2001.OO
 In the 45° corners, the corner joints in the external tubular section, must always be glued and caulked. Caulking may also be carried out by hand with equipment Art.M.2001.OO

SEZ. 6221

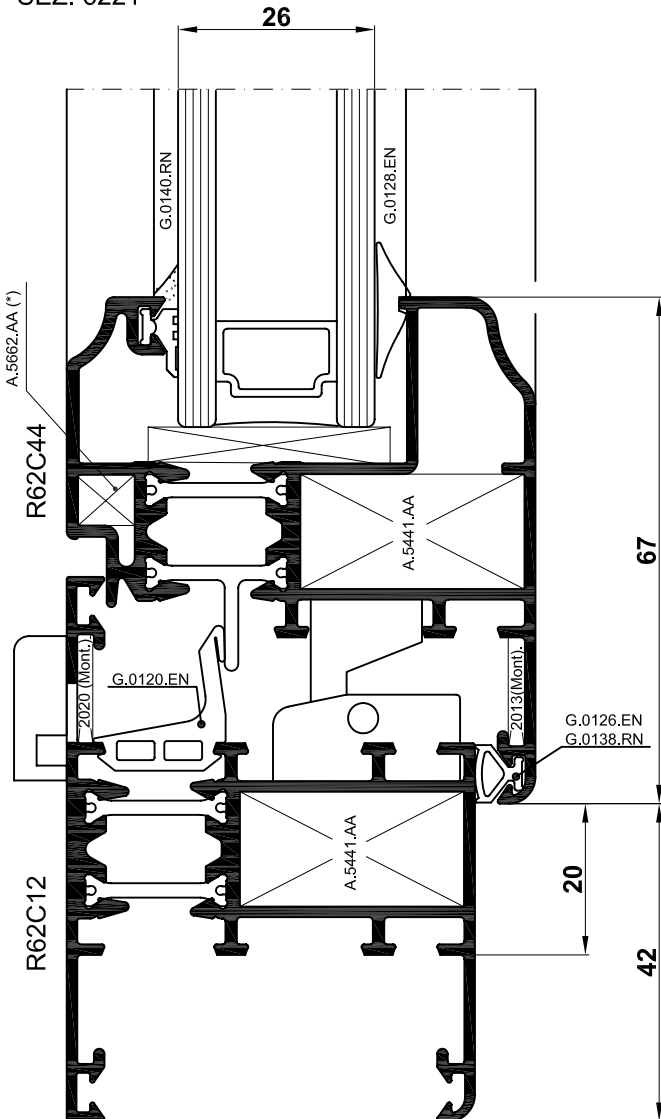

SEZ. 6222

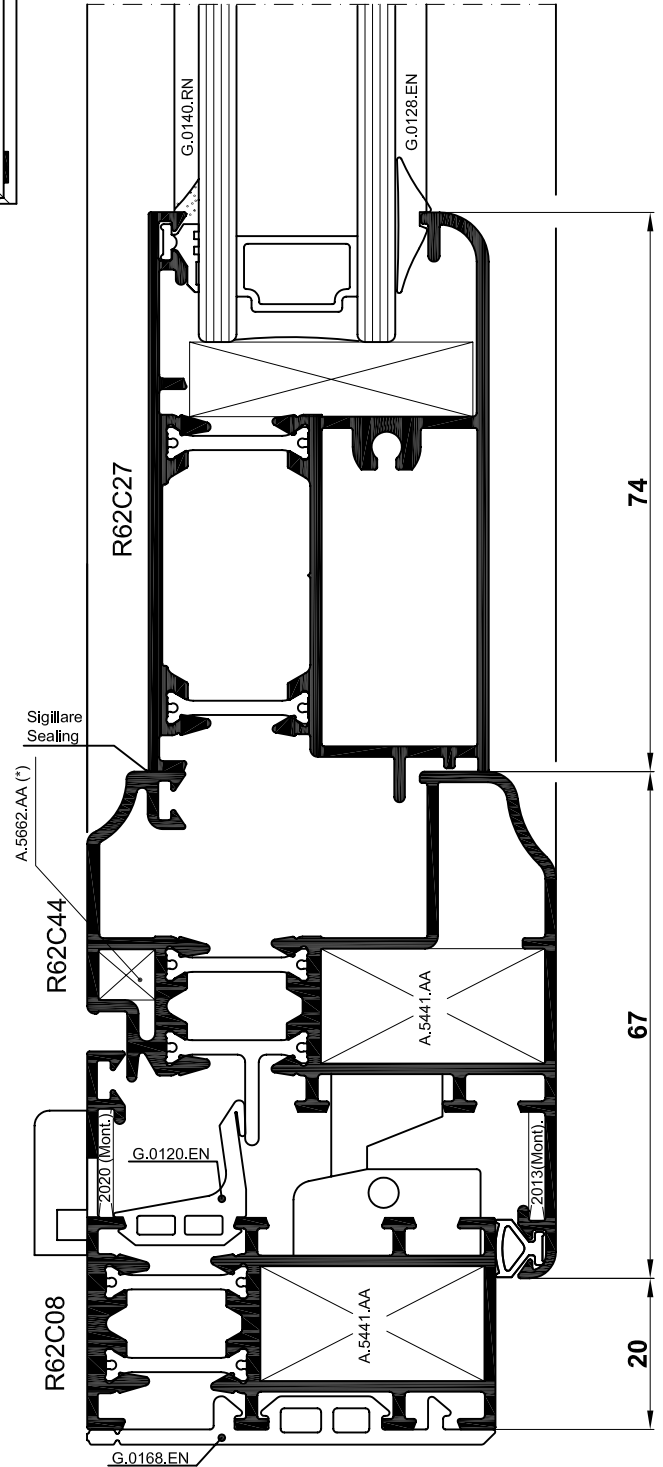

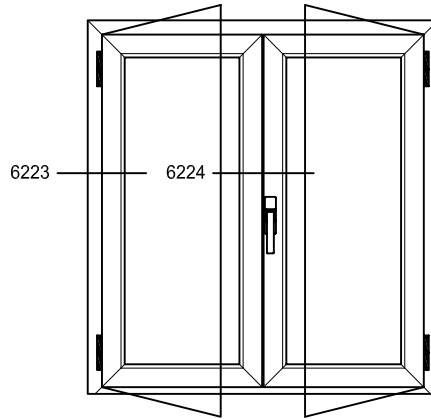

(*) Negli angoli a 45° le squadrette inserite nel tubolare esterno devono essere sempre incollate e cianfrinate. Cianfrinatura eseguibile anche con attrezzatura manuale Cod. M.2001.OO
In the 45° corners, the corner joints in the external tubular section, must always be glued and caulked. Caulking may also be carried out by hand with equipment Art.M.2001.OO

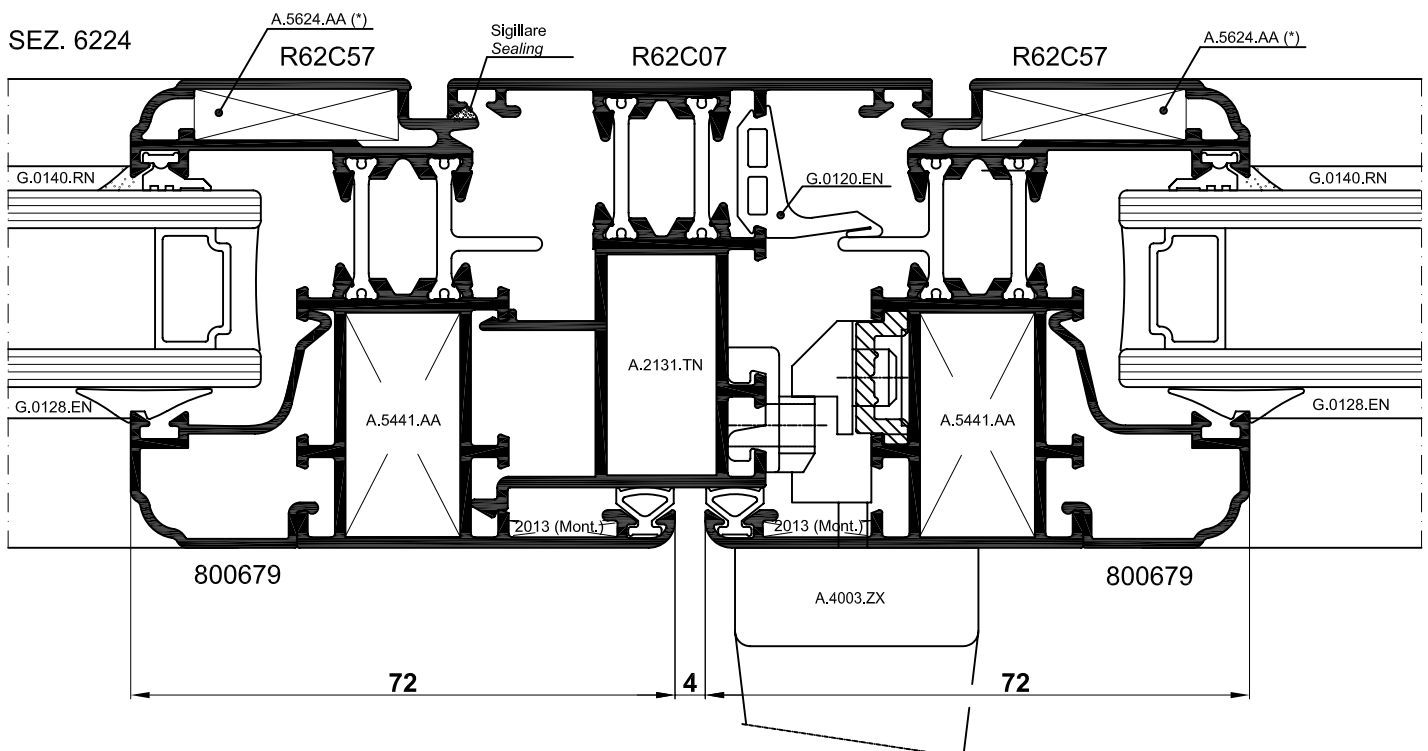
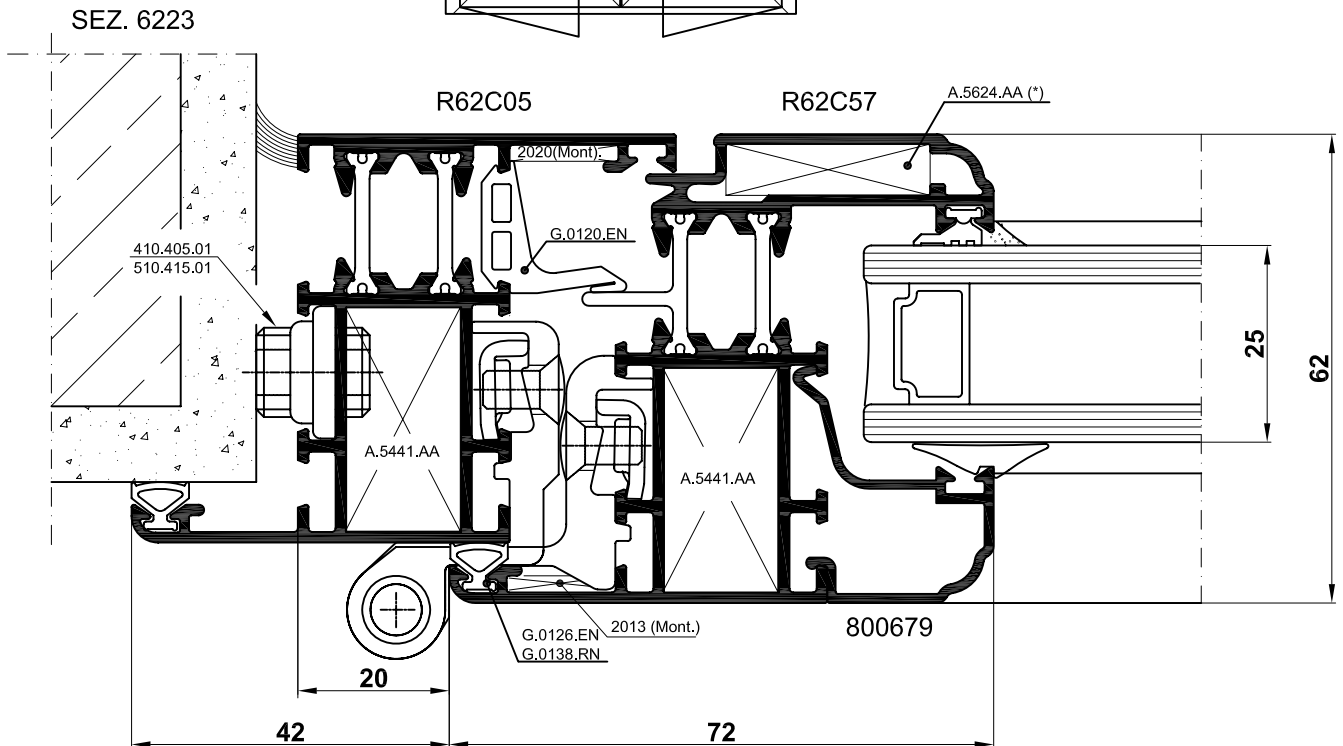

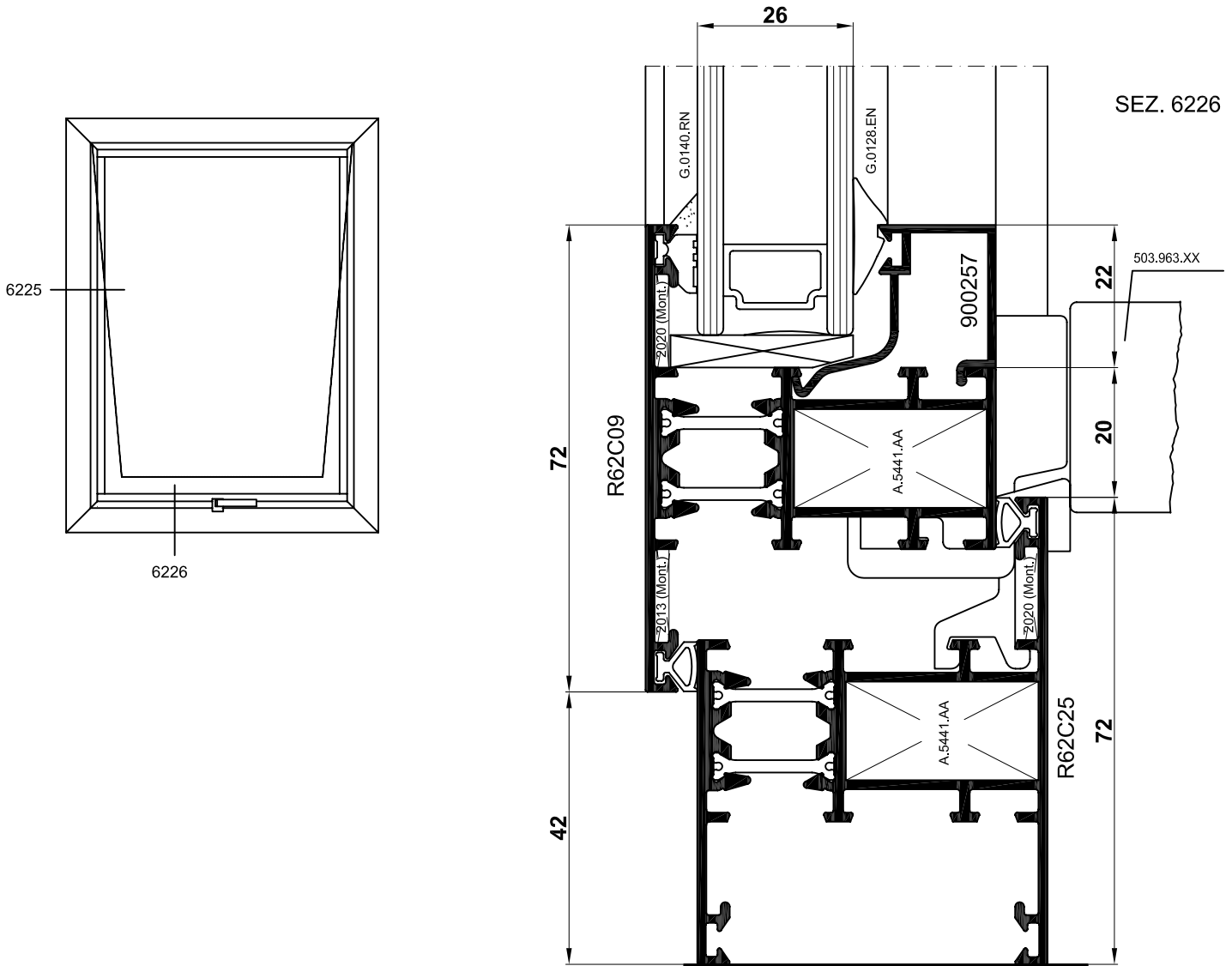

SEZ. 6225

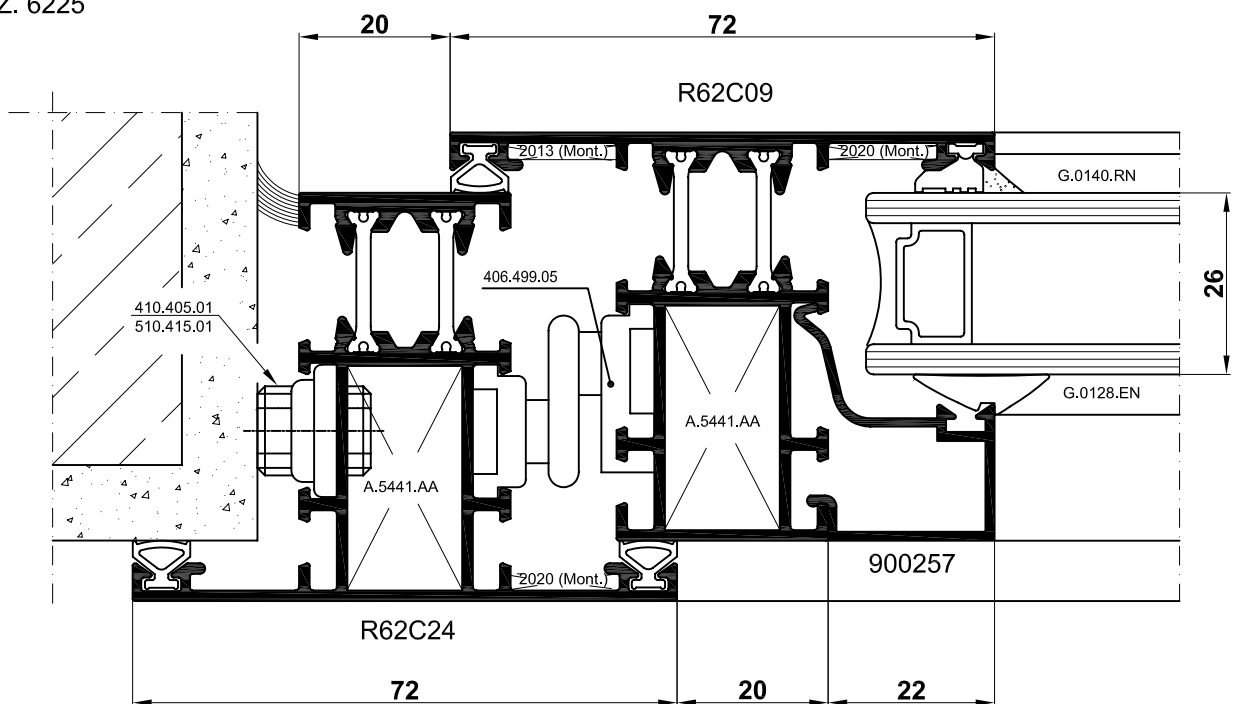

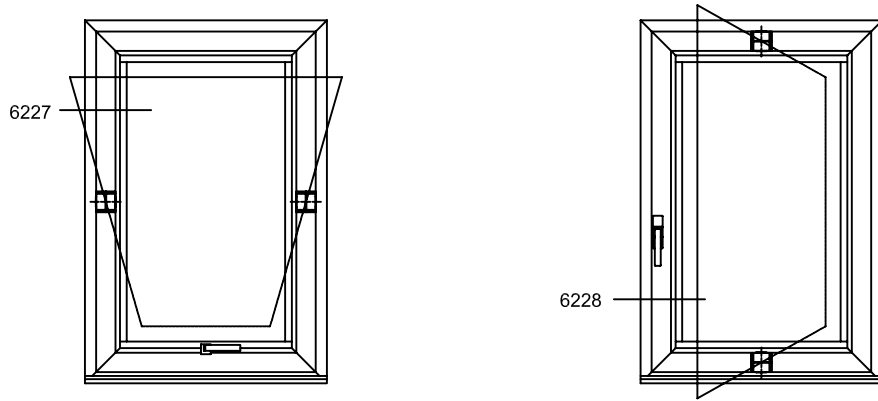

SEZ. 6227
 SEZ. 6228

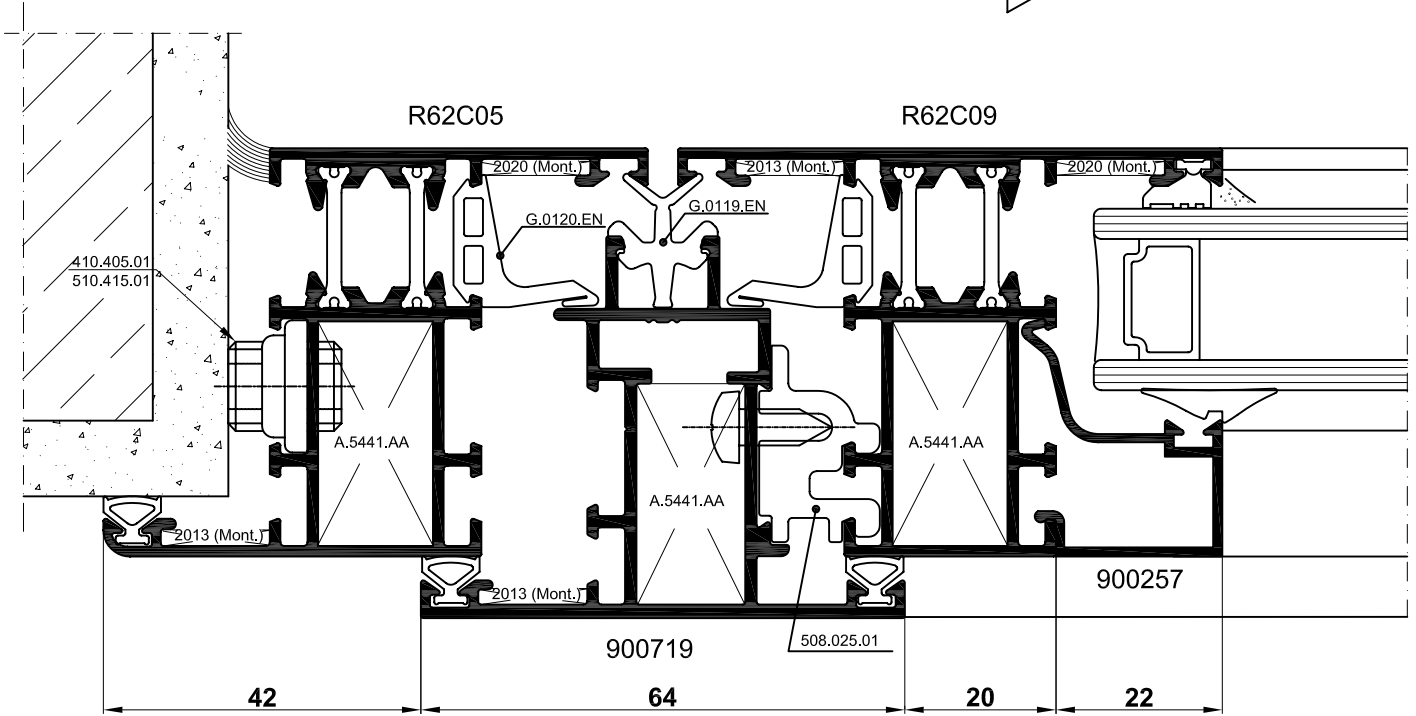

SEZIONI - LAVORAZIONE PROFILATO 900719
CROSS SECTIONS - TOOLING FOR SECTION 900719

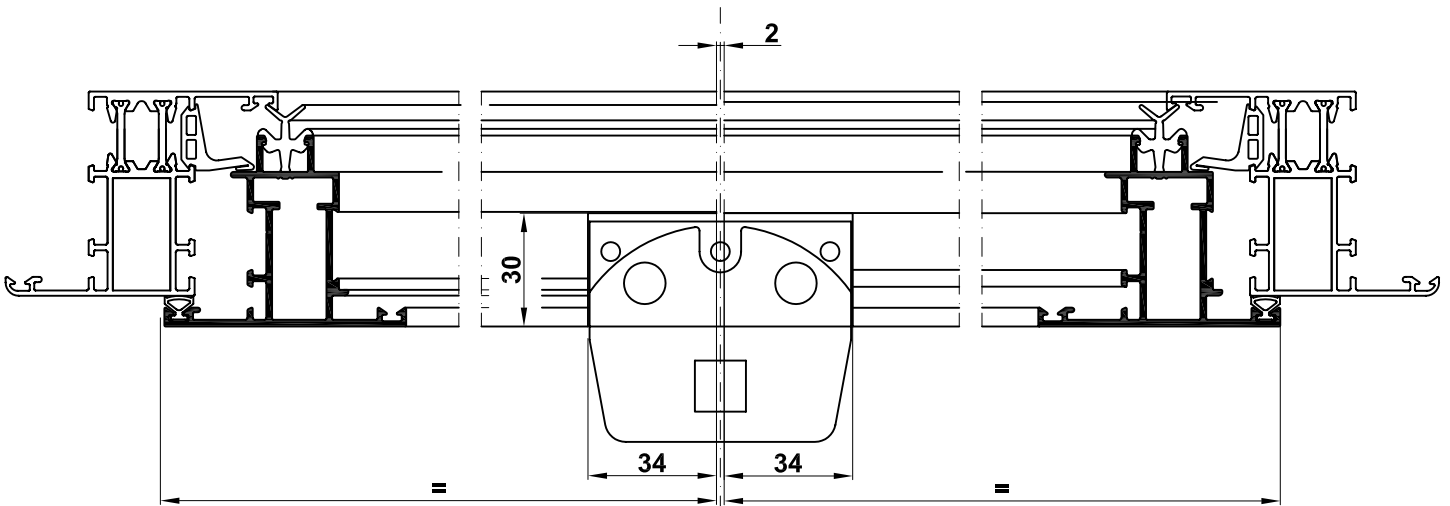

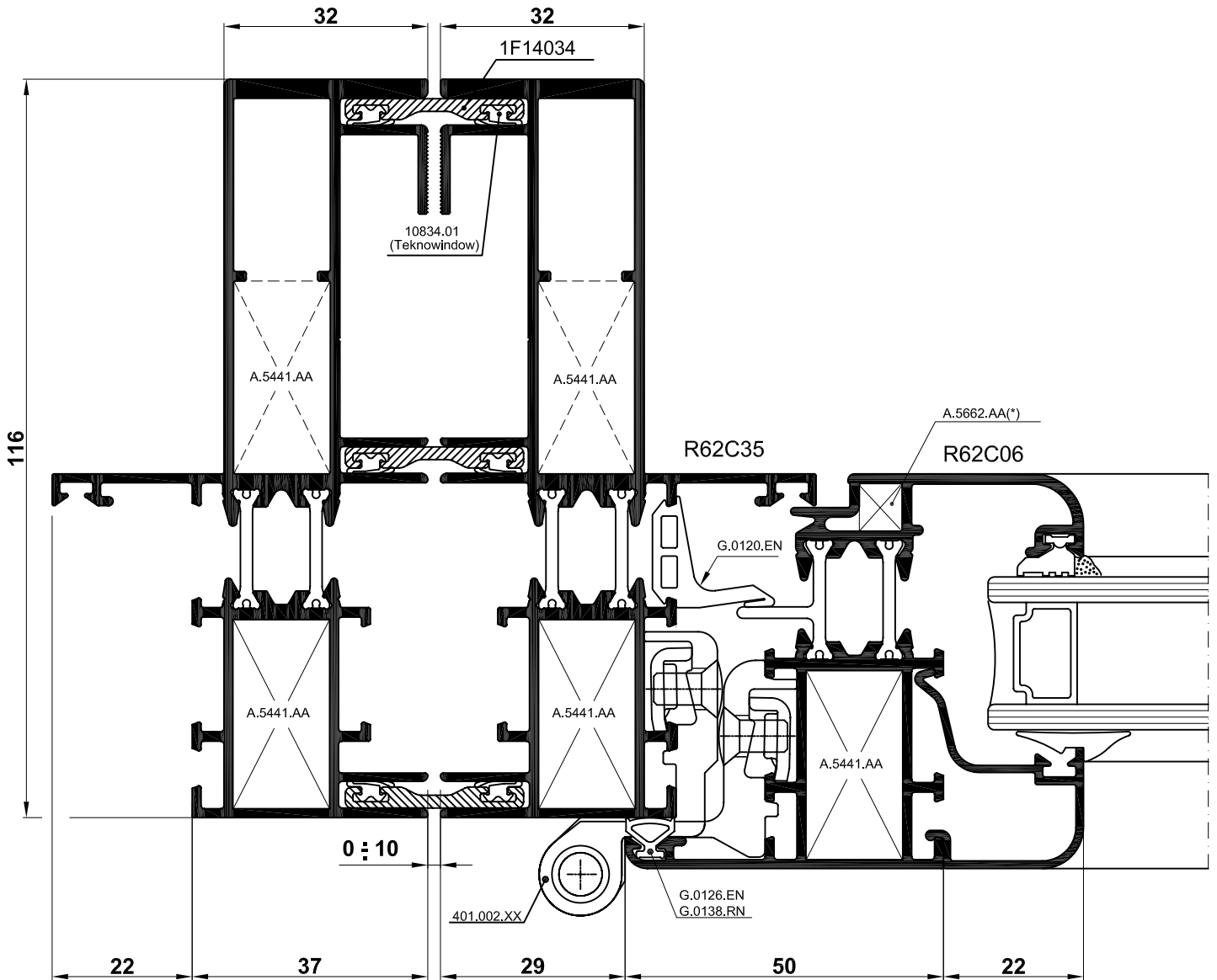

SEZIONI - APPLICAZIONE SOGLIA E PORTAGUARNIZIONE SOTTOZOCOLO
 SECTIONS - APPLICATION OF THRESHOLD AND SKIRTING BOARD WEATHERSTRIP HOLDER

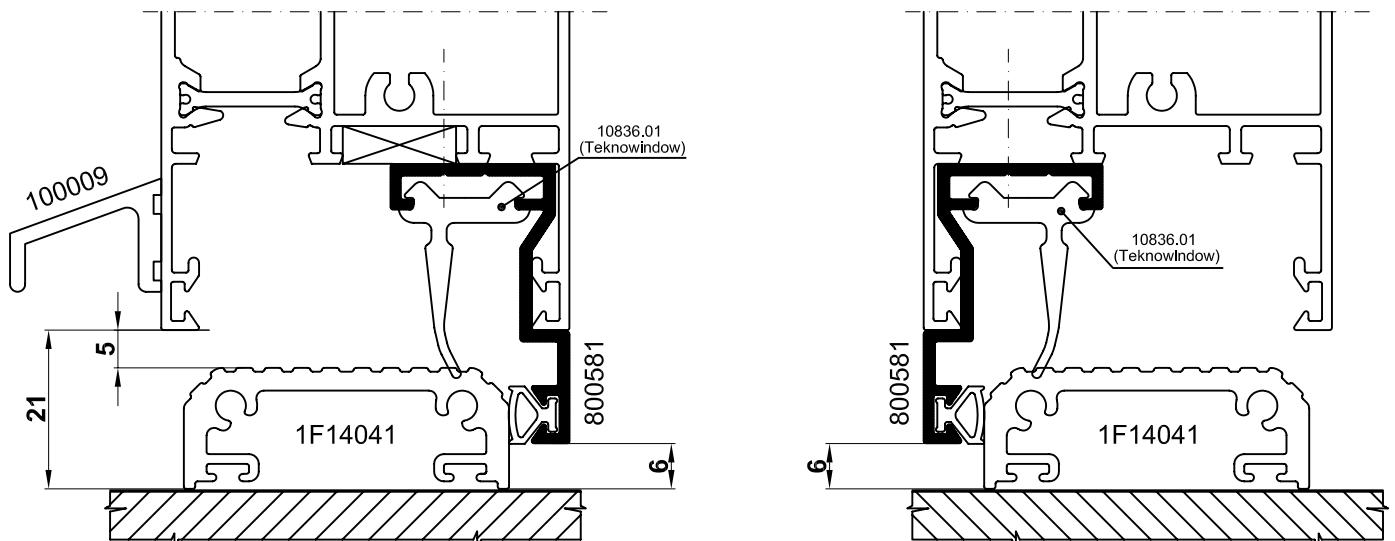

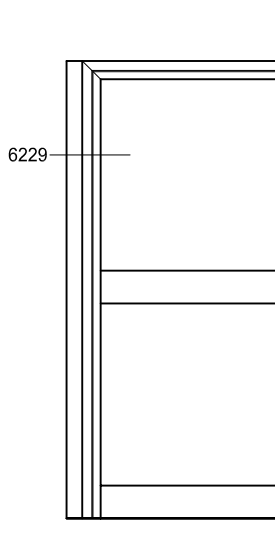

SEZ. 6229

(*) Negli angoli a 45° le squadrette inserite nel tubolare esterno devono essere sempre incollate e cianfrinate. Cianfrinatura eseguibile anche con attrezzatura manuale Cod. M.2001.OO
In the 45° corners, the corner joints in the external tubular section, must always be glued and caulked. Caulking may also be carried out by hand with equipment Art.M.2001.OO

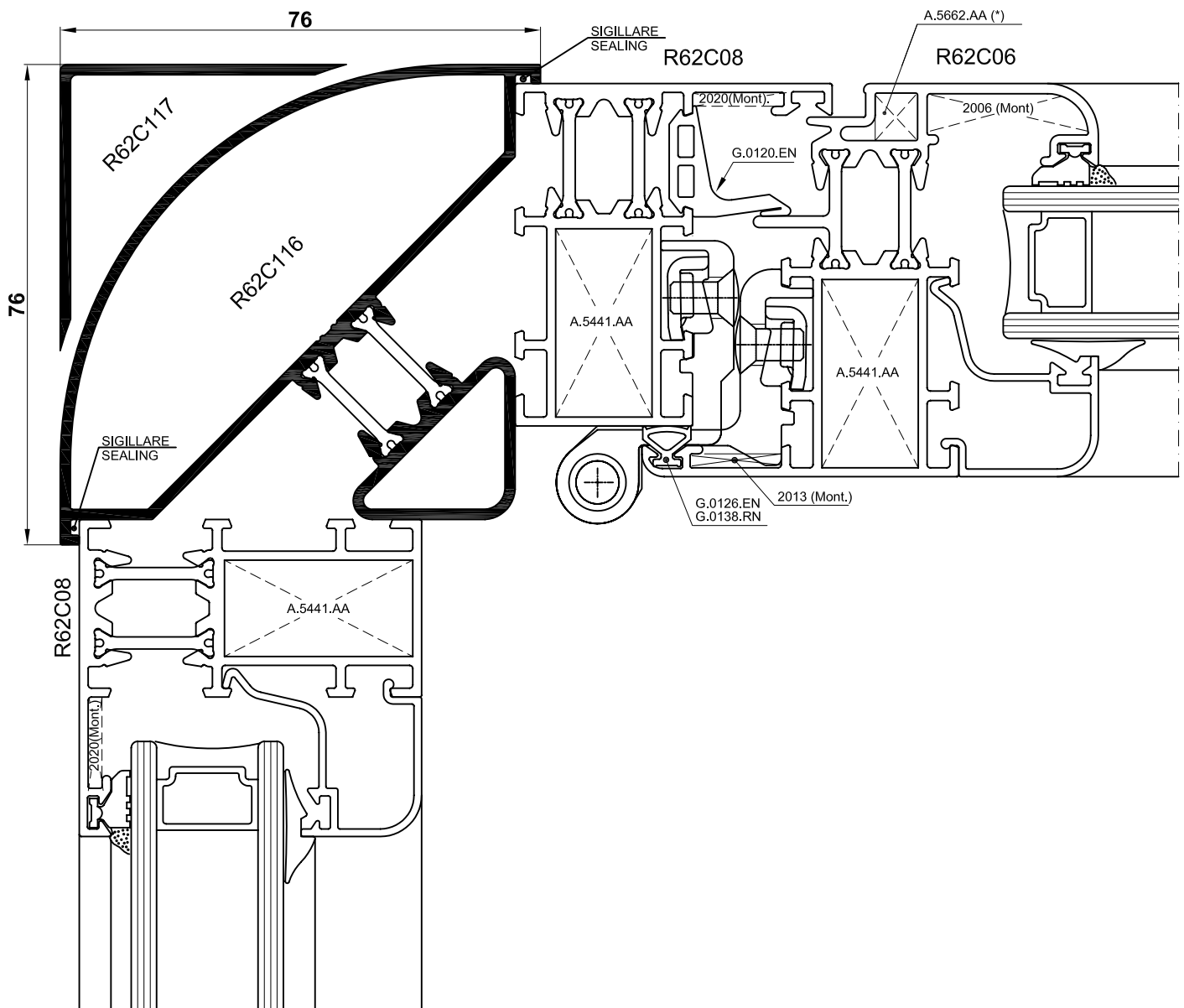

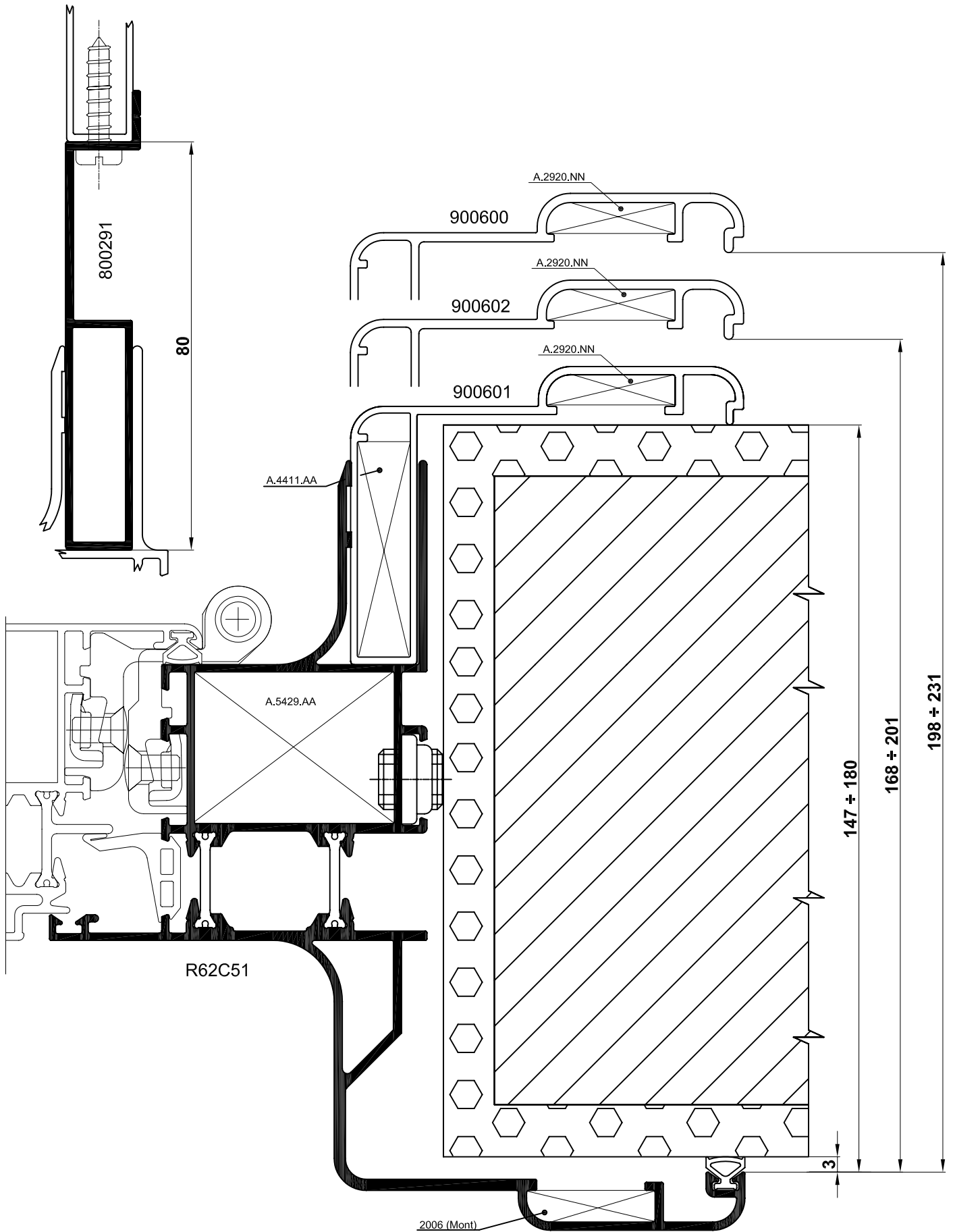

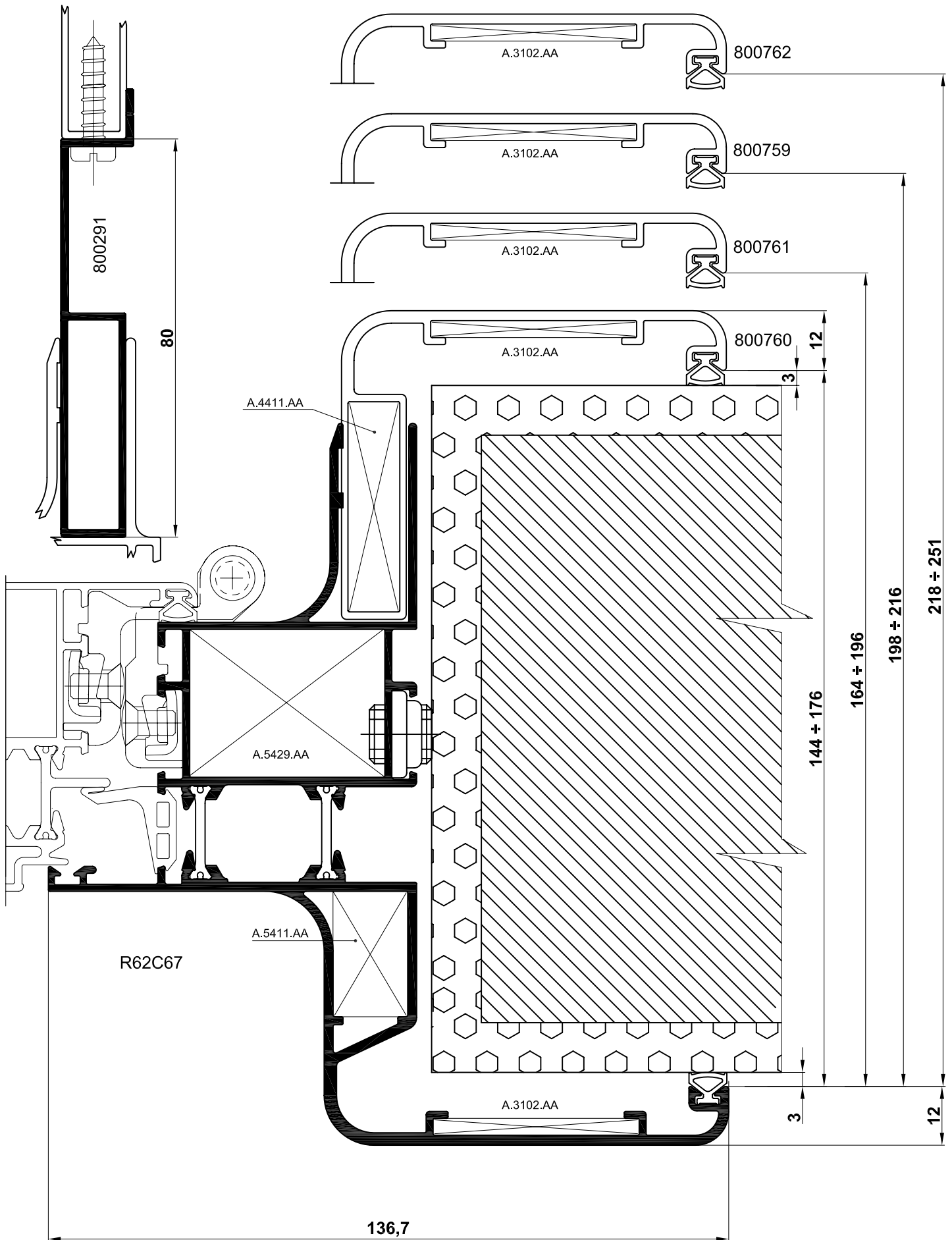

Profilati Sections		Spessore Muro Wall Thickness
Ester.	Inter.	mm
800760	800760	x= 155÷221
800760	800761	x= 175÷241
800760	800759	x= 209÷259
800760	800762	x= 230÷296
800761	800760	x= 175÷233
800761	800761	x= 195÷261
800761	800759	x= 229÷279
800761	800762	x= 250÷316
800759	800760	x= 209÷259
800759	800761	x= 229÷279
800759	800759	x= 264÷299
800759	800762	x= 284÷334
800762	800760	x= 230÷296
800762	800761	x= 250÷316
800762	800759	x= 284÷334
800762	800762	x= 305÷371

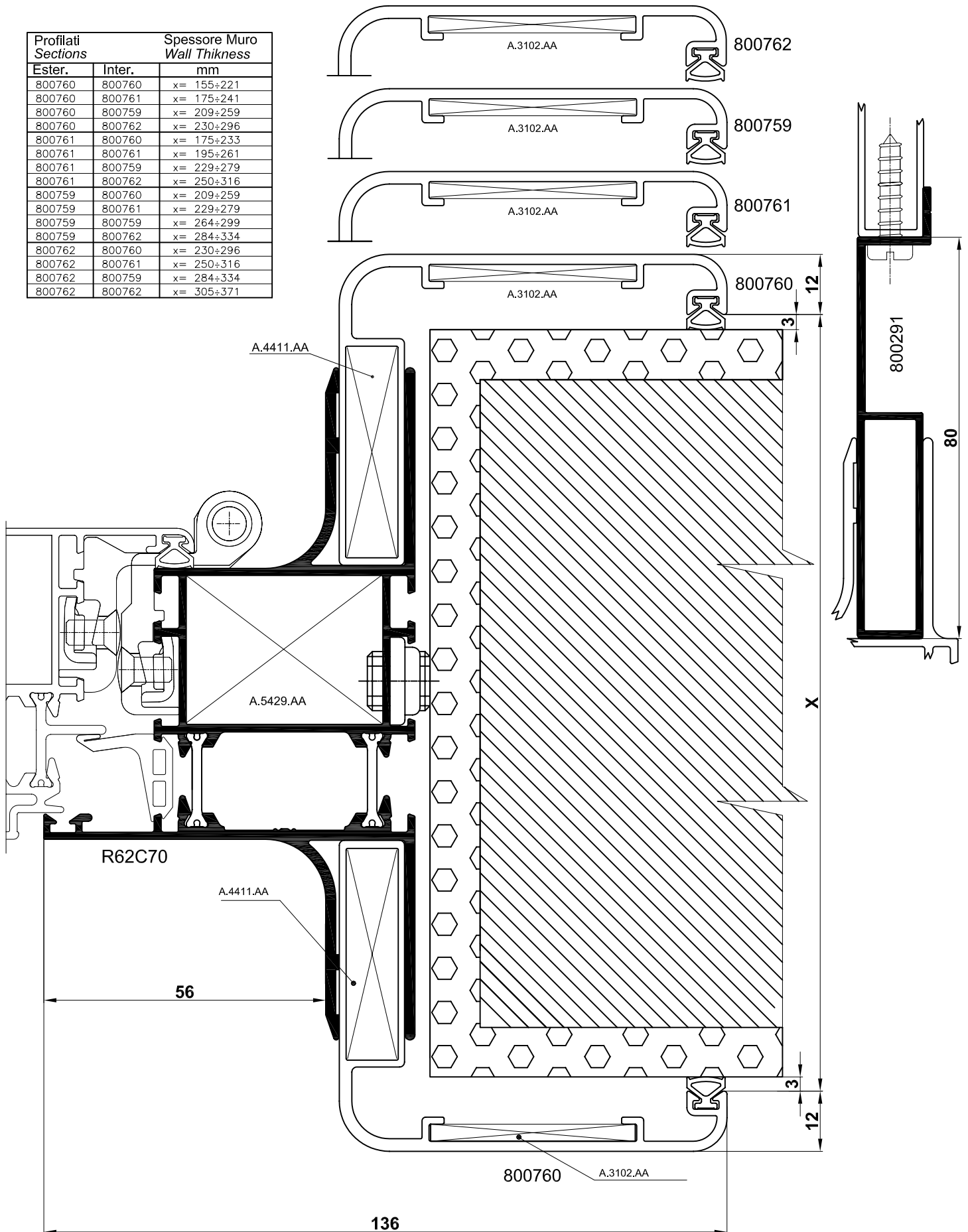

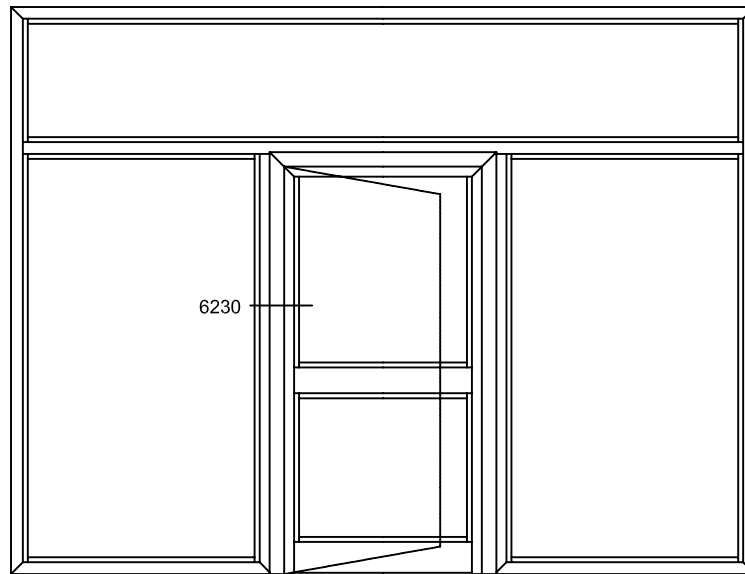

SEZ. 6230

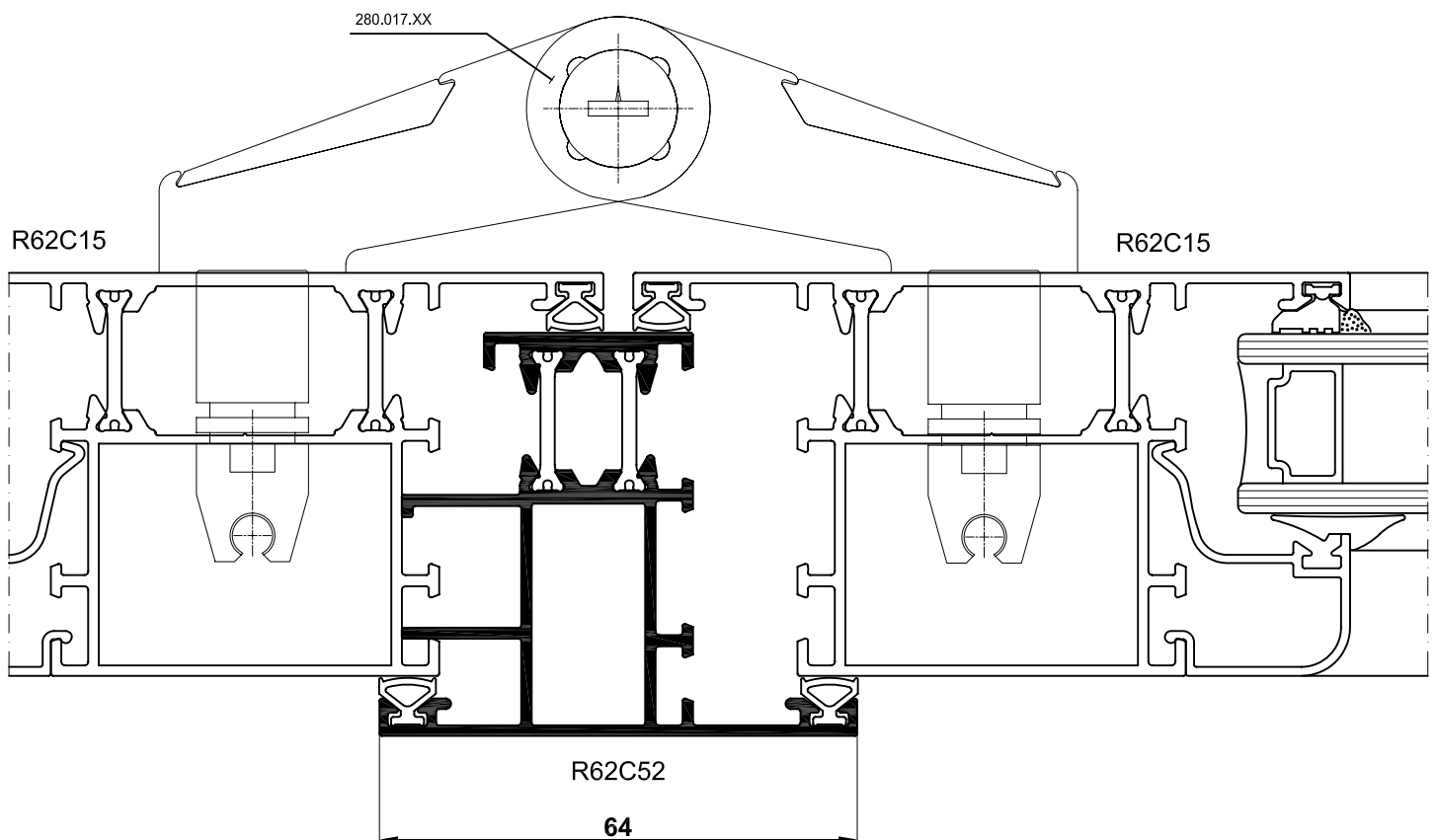

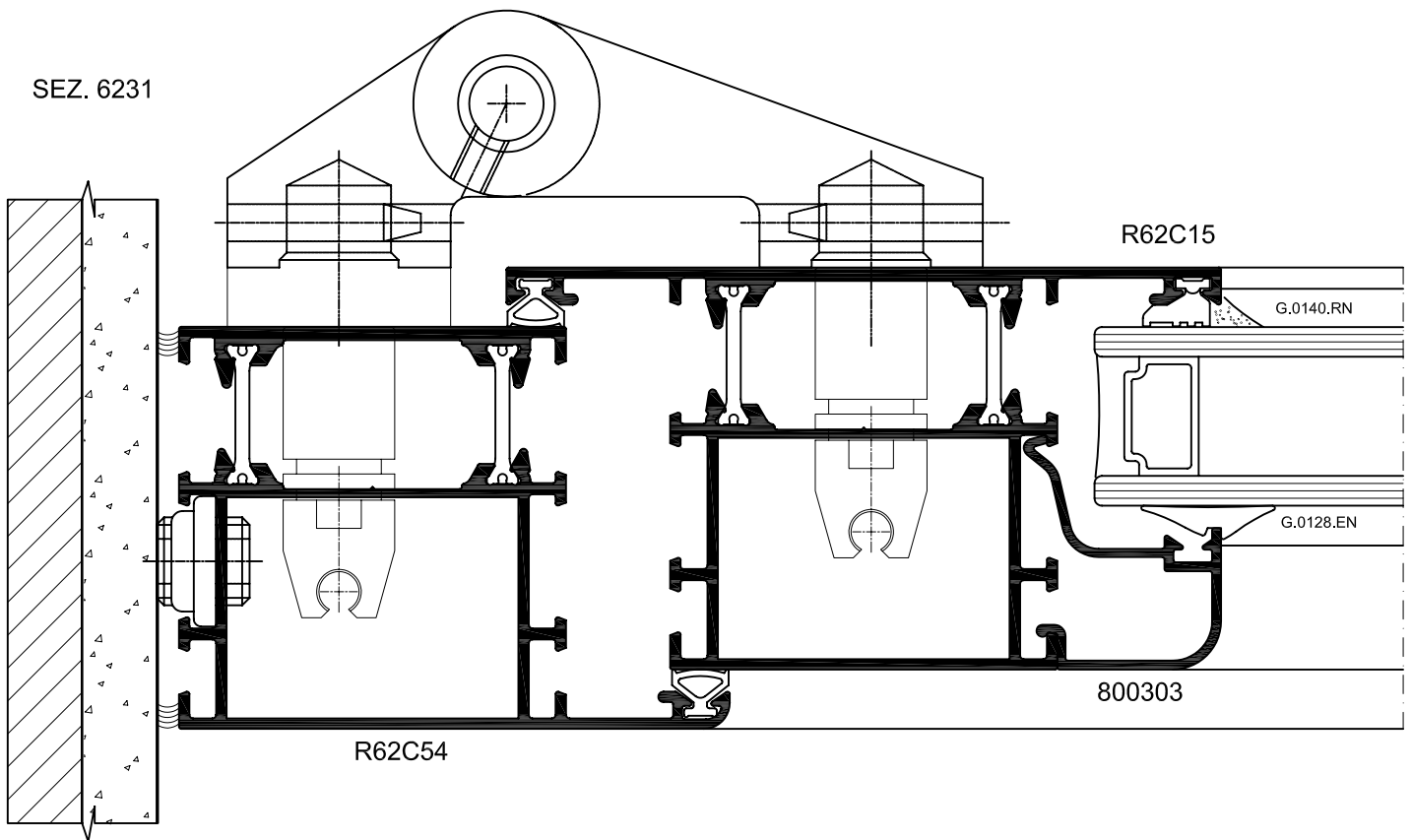
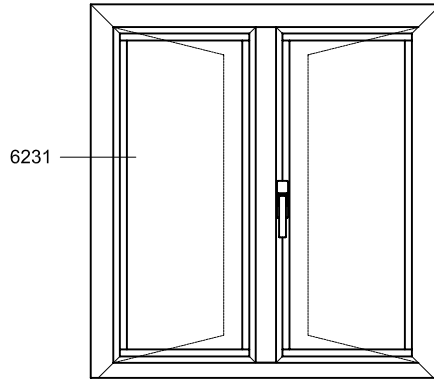

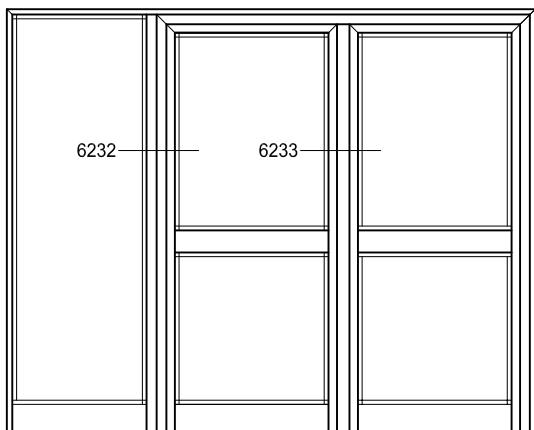

* Asportare dentini per l'altezza del tappo A.2131.TN
 Removed pins for the total height on the plug A.2131.TN

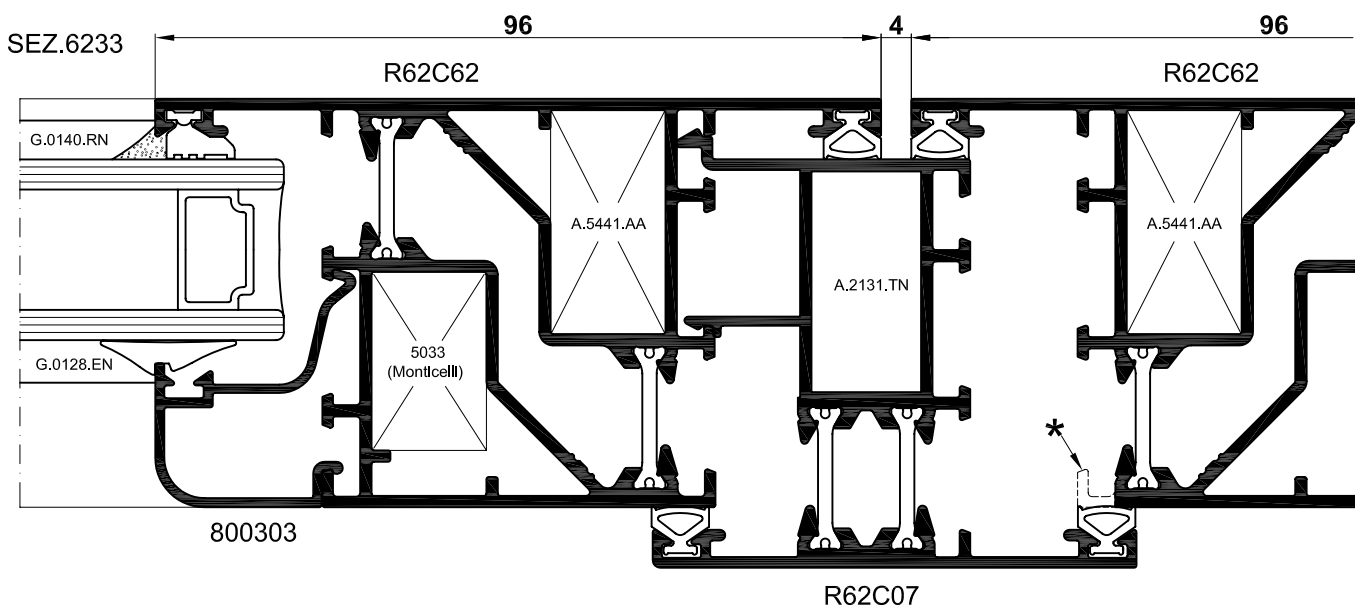
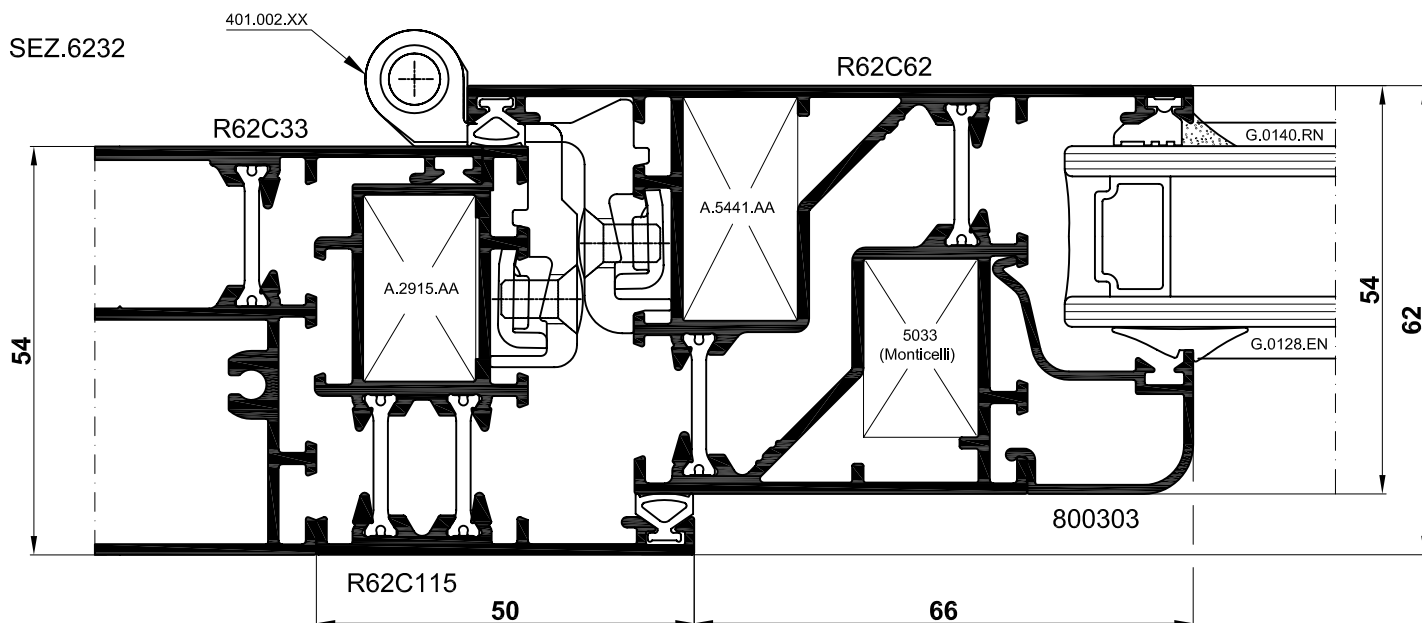

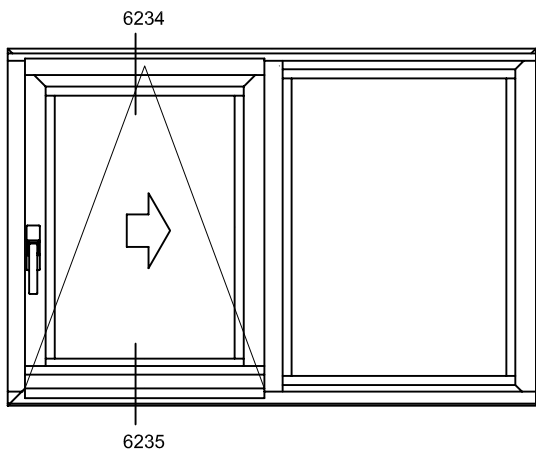

SEZ. 6234

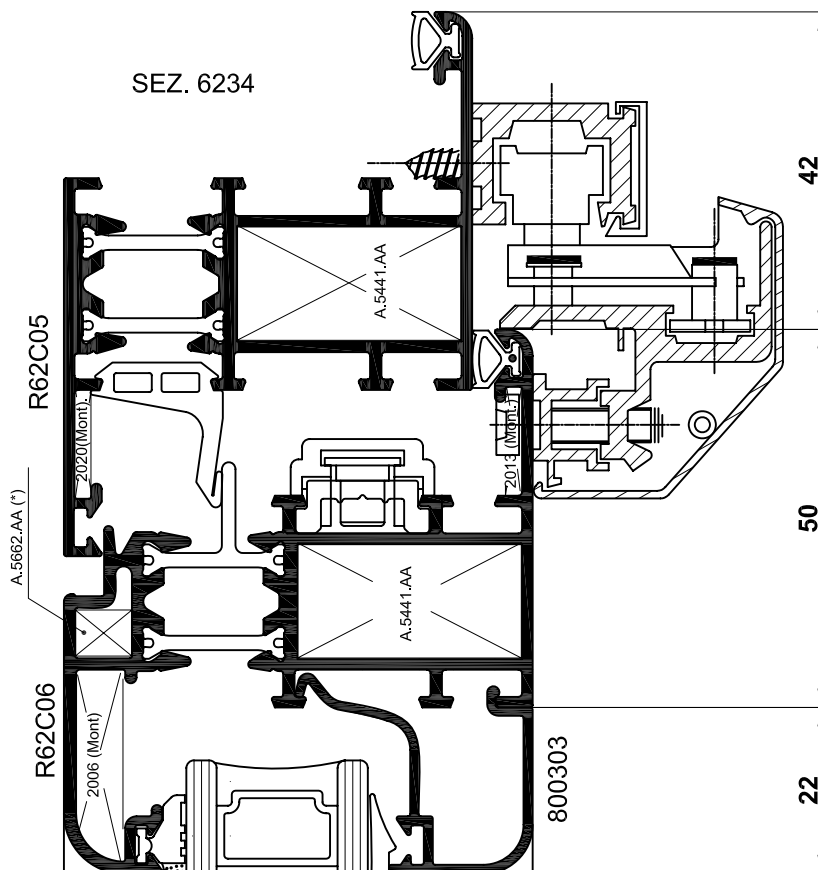

(*) Negli angoli a 45° le squadrette inserite nel tubolare esterno devono essere sempre incollate e cianfrinate. Cianfrinatura eseguibile anche con attrezzatura manuale Cod. M.2001.OO
 In the 45° corners, the corner joints in the external tubular section, must always be glued and caulked. Caulking may also be carried out by hand with equipment Art.M.2001.OO

SEZ. 6235

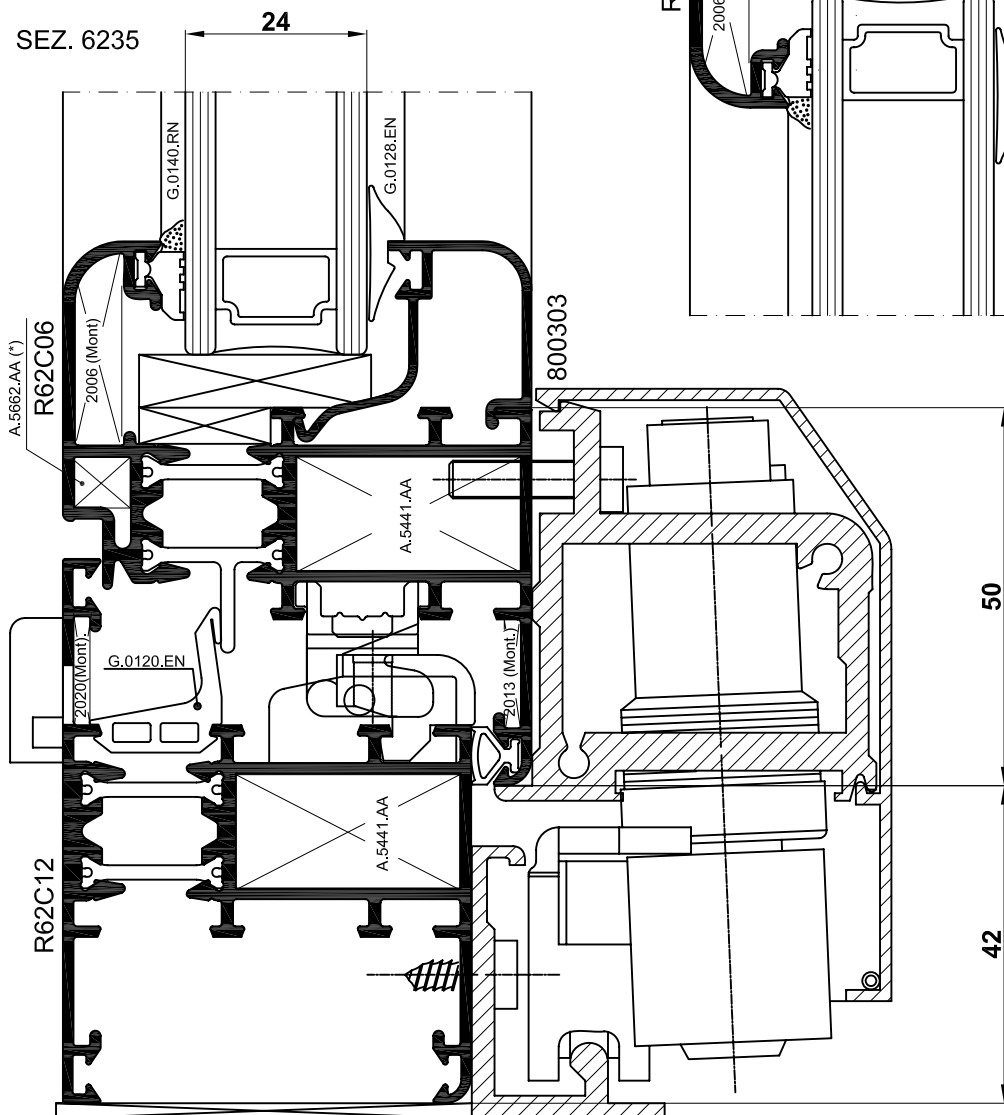

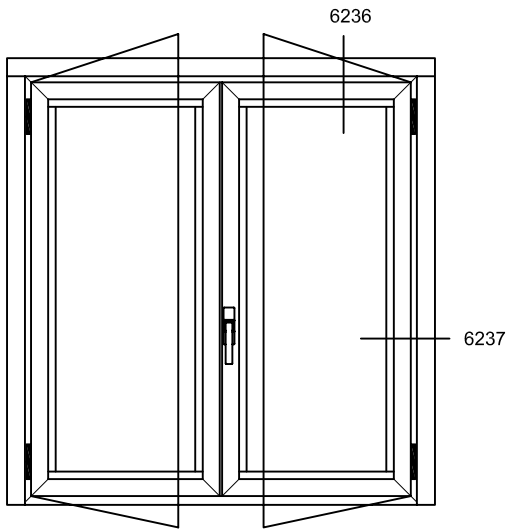

SEZ. 6236

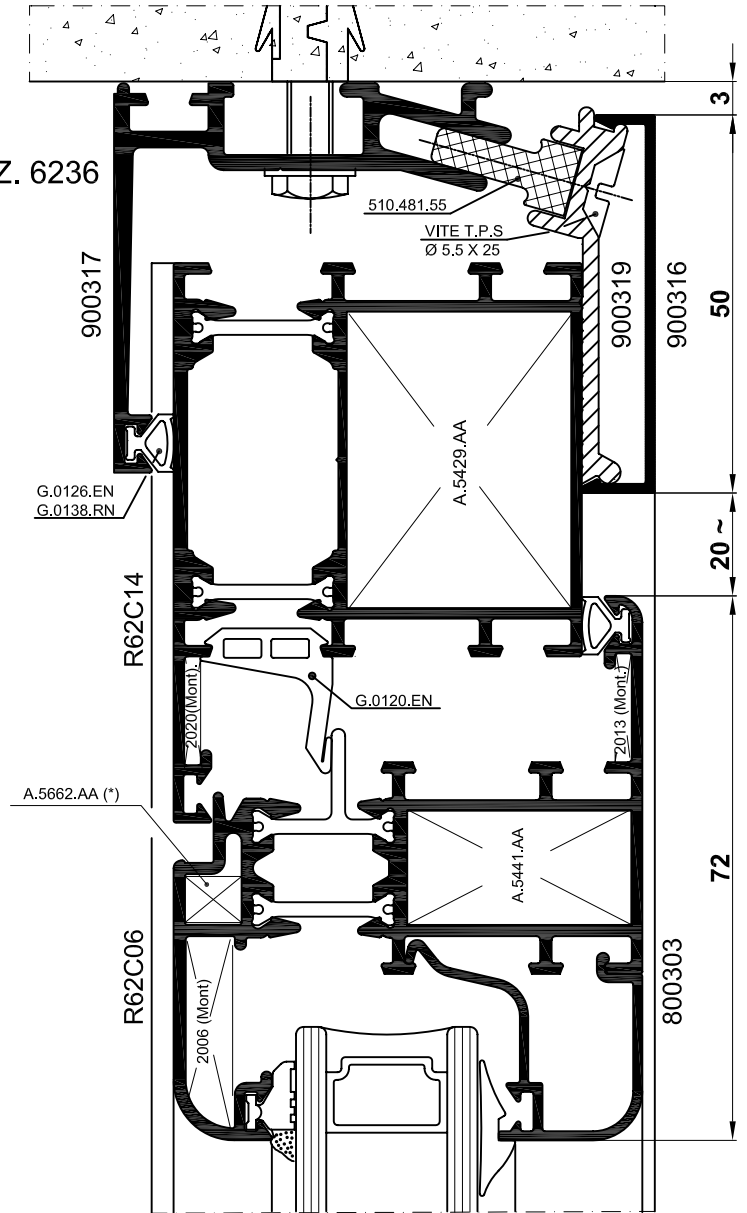

(*) Negli angoli a 45° le squadrette inserite nel tubolare esterno devono essere sempre incollate e cianfrinate.
 Cianfrinatura eseguibile anche con attrezzatura manuale Cod. M.2001.OO
 In the 45° corners, the corner joints in the external tubular section, must always be glued and caulked.
 Caulking may also be carried out by hand with equipment Art.M.2001.OO

SEZ. 6237

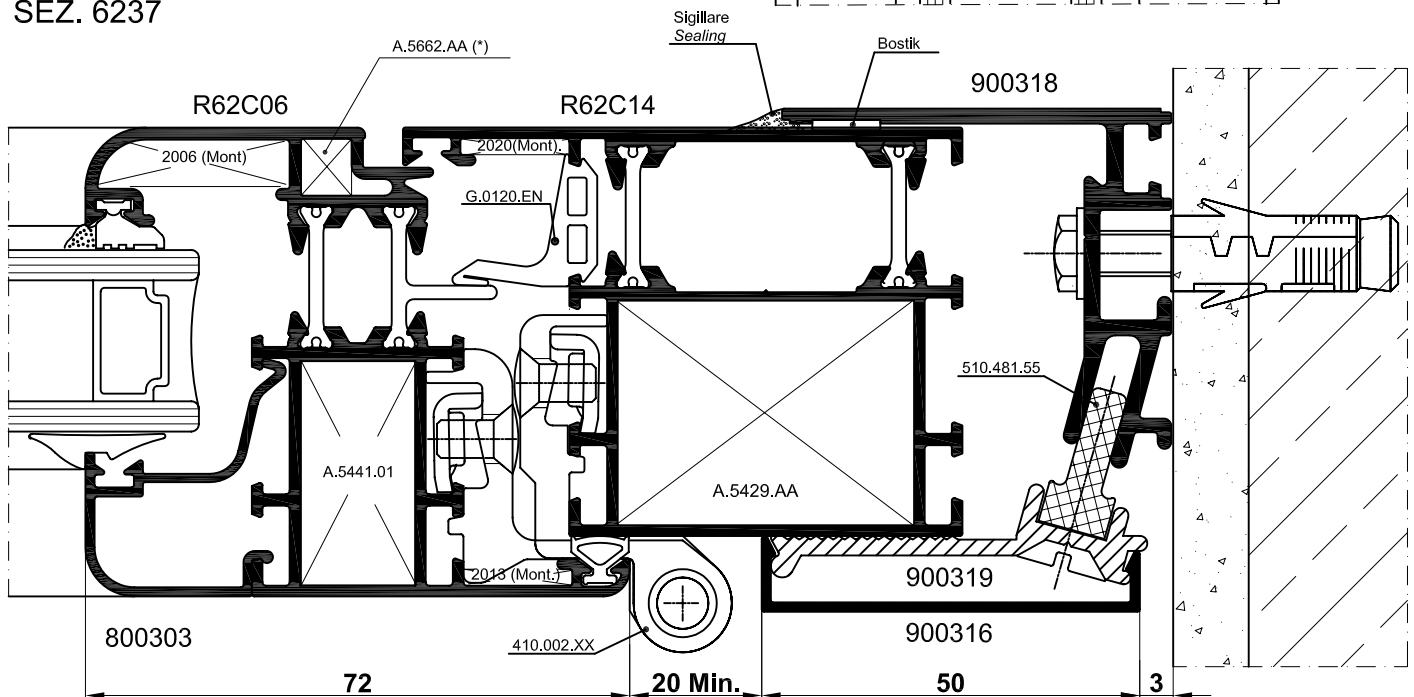

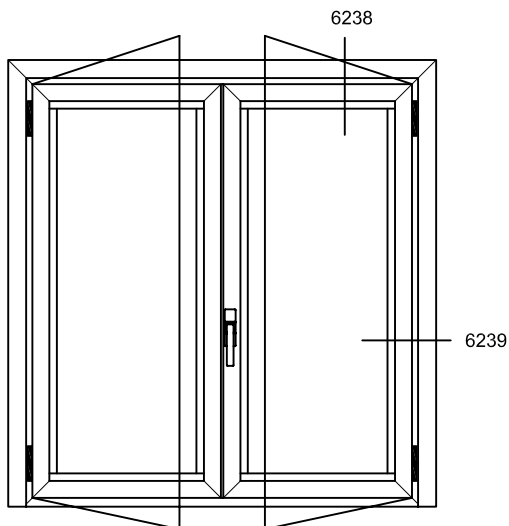

SEZ. 6238

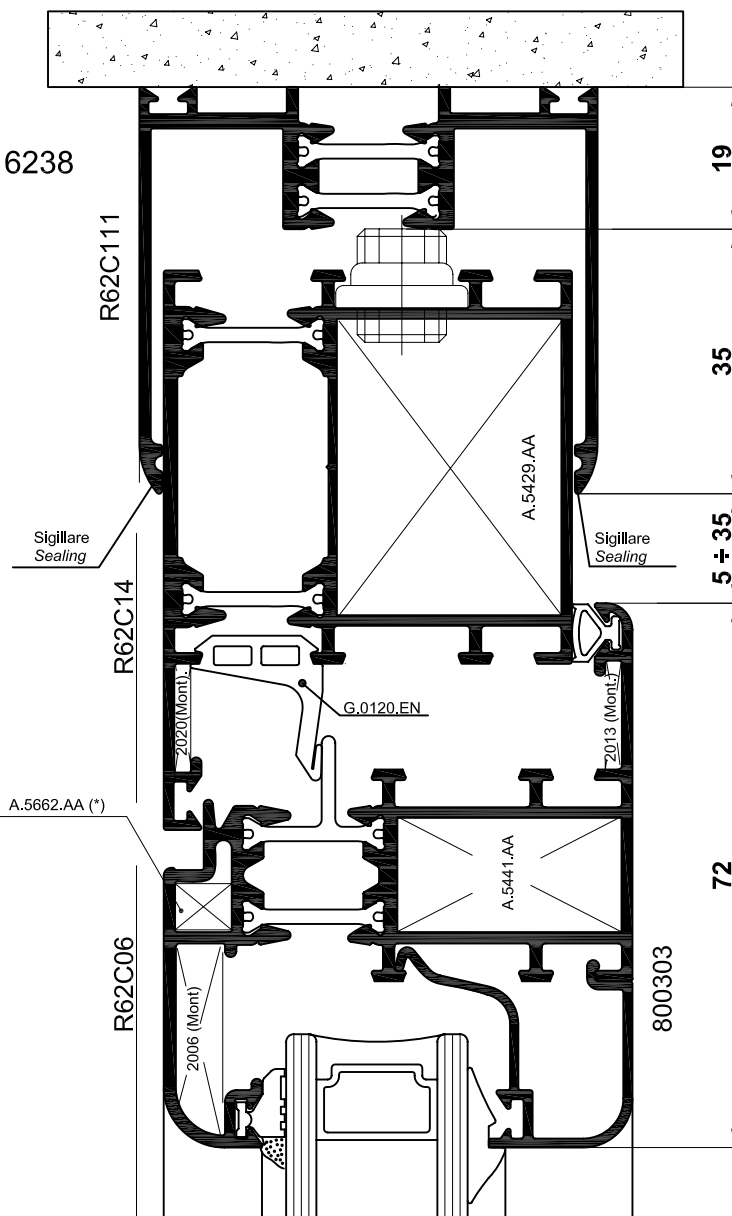

(*) Negli angoli a 45° le squadrette inserite nel tubolare esterno devono essere sempre incollate e cianfrinate.
 Cianfrinatura eseguibile anche con attrezzatura manuale Cod. M.2001.OO
In the 45° corners, the corner joints in the external tubular section, must always be glued and caulked. Caulking may also be carried out by hand with equipment Art.M.2001.OO

SEZ. 6239

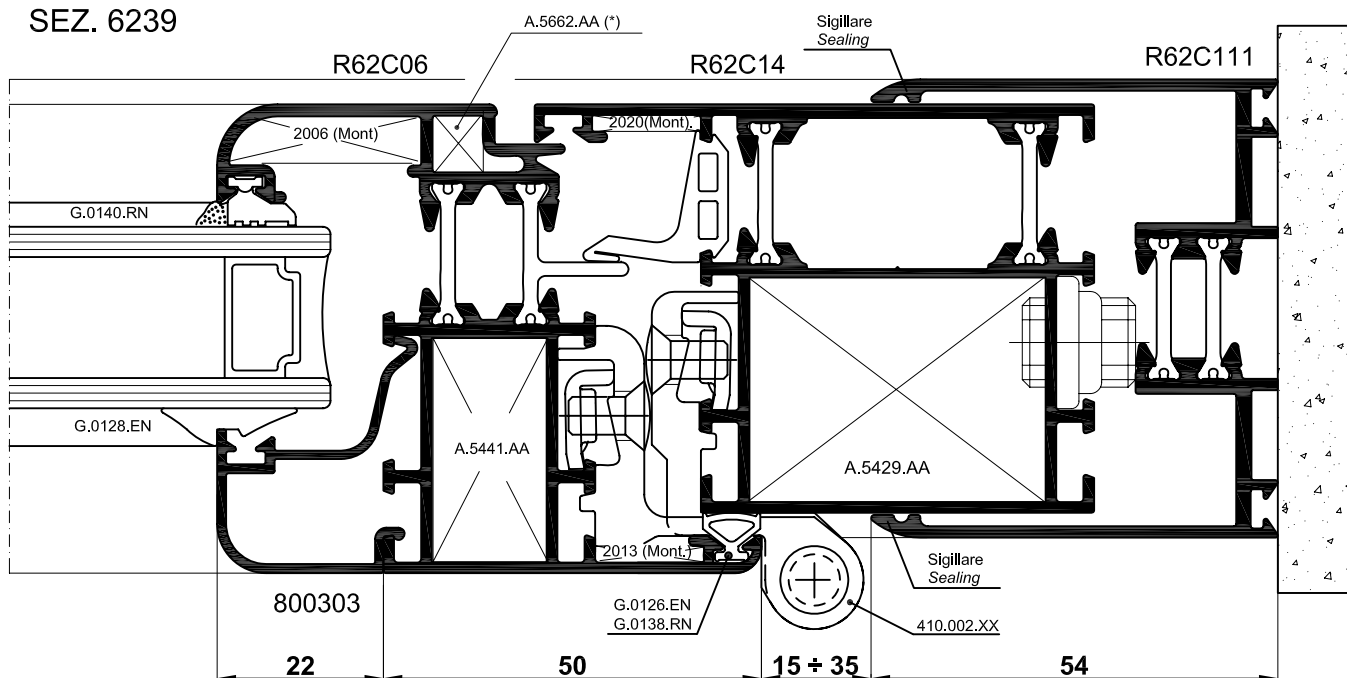

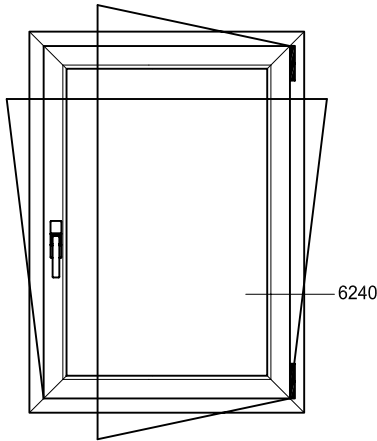

CAMPO DI APPLICAZIONE
APPLICATION RANGE

H	2800	50	50	40	30	28	24	22	20	18	16	14	14	13	13	12
	2700	50	50	40	30	28	24	22	20	18	16	14	14	13	13	13
	2600	50	50	40	35	30	26	22	20	18	16	16	14	14	13	13
	2500	50	50	40	35	30	26	24	22	20	18	16	14	14	13	13
	2400	50	50	45	35	30	28	24	22	20	18	16	16	14	14	13
	2300	50	50	45	35	30	28	26	24	22	20	18	16	16	14	14
	2200	50	50	50	40	35	30	26	24	22	20	18	18	16	14	14
	2100	50	50	50	40	35	30	28	26	24	22	20	18	16	16	14
	2000	50	50	50	45	35	30	30	28	24	22	20	18	18	16	16
	1900	50	50	50	45	40	35	30	28	26	24	22	20	18	18	16
	1800	50	50	50	50	40	35	30	30	28	26	22	22	20	18	18
	1700	50	50	50	50	45	40	35	30	30	26	24	22	20	20	18
	1600	50	50	50	50	50	40	35	35	30	28	26	24	22	20	20
	1500	50	50	50	50	50	45	40	35	30	30	28	26	24	22	20
1400	50	50	50	50	50	45	40	40	35	30	30	28	26	24	●	
1300	50	50	50	50	50	50	45	40	35	35	30	30	26	●	●	
1200	50	50	50	50	50	50	50	45	40	35	35	30	●	●	●	
1100	50	50	50	50	50	50	50	50	45	40	35	●	●	●	●	
1000	50	50	50	50	50	50	50	50	50	40	●	●	●	●	●	
900	50	50	50	50	50	50	50	50	50	●	●	●	●	●	●	
800	50	50	50	50	50	50	50	50	●	●	●	●	●	●	●	
700	50	50	50	50	50	50	50	●	●	●	●	●	●	●	●	
600	50	50	50	50	50	50	●	●	●	●	●	●	●	●	●	
		350	400	500	600	700	800	900	1000	1100	1200	1300	1400	1500	1600	1700
		L														

(*) Negli angoli a 45° le squadrette inserite nel tubolare esterno devono essere sempre incollate e cianfrinate. Cianfrinatura eseguibile anche con attrezzatura manuale Cod. M.2001.OO
In the 45° corners, the corner joints in the external tubular section, must always be glued and caulked. Caulking may also be carried out by hand with equipment Art.M.2001.OO

PER MAGGIORI CHIARIMENTI
CONSULTARE SP.918.01
FOR MORE DETAILS
CONSULT SP.918.01

H = Altezza anta mobile
H = Height of the moving leaf
L = Larghezza anta mobile
L = Width of the moving leaf

● Non eseguibile
Not feasible

28 Max spessore vetro 28 mm
Max glass thickness 28 mm

N.B. Lo spessore vetro si riferisce al materiale senza camera d'aria
N.B. Glass thickness refers to material without air chamber

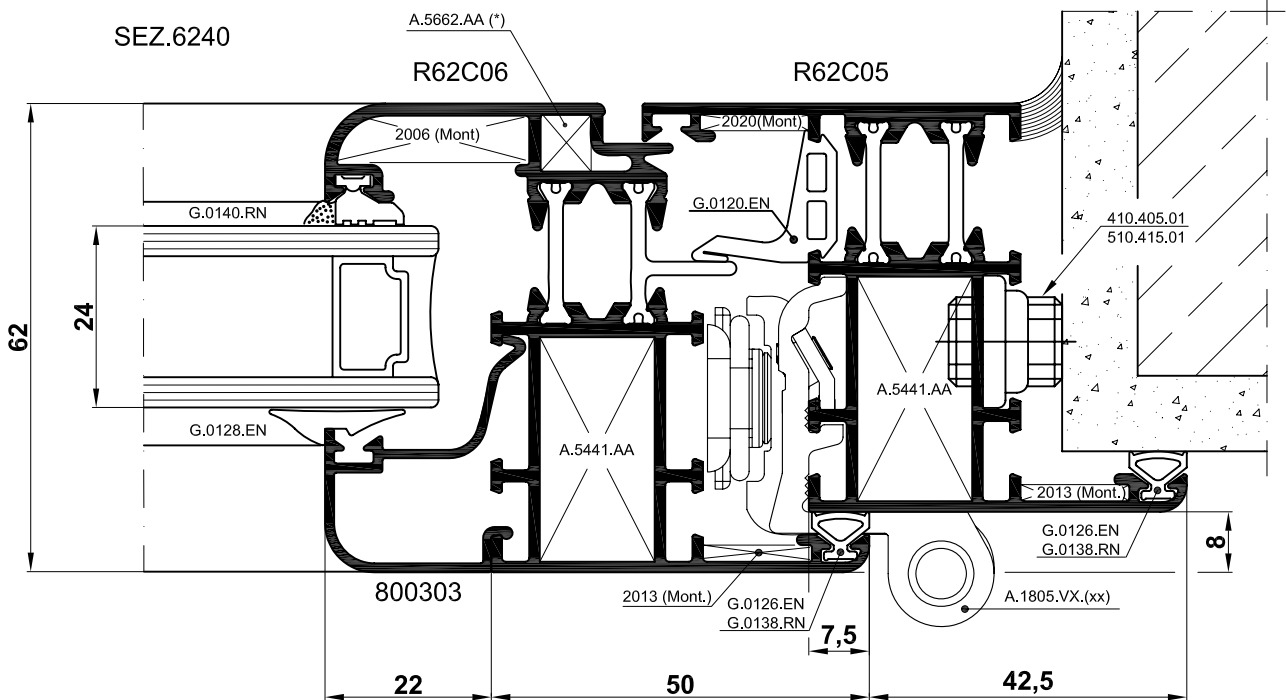

FINESTRA 1 ANTA
ONE-WING WINDOW

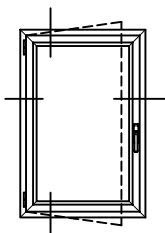

N.B: - Le dimensioni di taglio e di lavorazione indicate nelle pagine seguenti sono state ottenute considerando le quote teoriche.
Pertanto è necessario verificare sempre le dimensioni dei profilati prima di effettuare i tagli.
Sapa declina ogni responsabilità per errori dovuti al mancato controllo da parte del costruttore.

N.B: - The cutting and processing dimensions, indicated in the following pages, are obtained considering theoretical values.
It is, therefore, always necessary to check the dimensions of the profiles before executing the cutting.
Sapa declines any responsibility from errors caused from the missing dimensional check of the carpenter

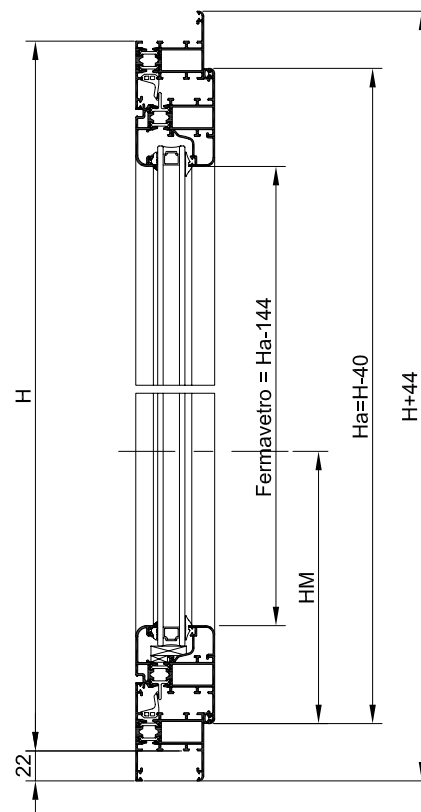
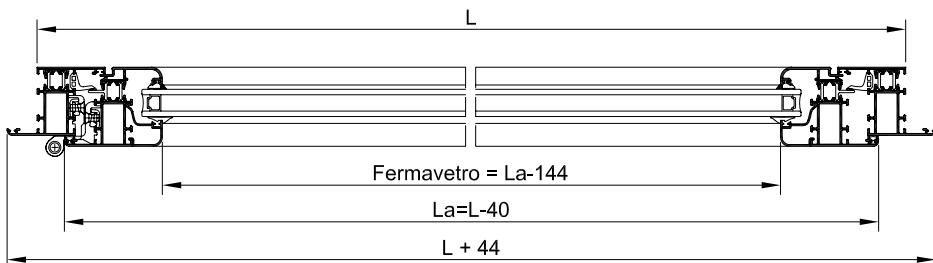

PROFILATI
SECTIONS

Profilato tipo Type Section	N° Pz.	Taglio Cut	N° Pz.	Taglio Cut
	2	 H + 44	1	 L + 44
			1	 L + 44
	2	 Ha = H - 40	2	 La = L - 40
	2	 Ha - 144	2	 La - 144
	1	(Inferiore/Lower) Hm - 113	1	(Superiore/Upper) Ha - Hm - 113

DIMENSIONI VETRO
GLASS SIZE

N. 1 PEZZO	N.B.: Spessore vetro considerato 20 mm (4+12+4) Gioco perimetrale tra profilato e vetro 5 mm For glass with 20 mm thickness Space between glass and profile 5 mm
Ha - 110	
La - 110	

ACCESSORI
ACCESSORIES

Articolo Item	Descrizione Description	N	Articolo Item	Descrizione Description	N	Articolo Item	Descrizione Description	N
404.110.55	Innesti per cremonese su prof 900221(cp) Pair of coupling internal opening for 900221	1	A.5662.AA	Squadretta a cianfrinare su prof. est. anta External corner joint to be crimped	4	510.415.01	Regolo mobile da 15 mm Adjustable block mm 15	5
404.145.05	Puntali in zama su prof. 900221 (cp) Pair of zamak terminals on profile 900221	1	401.002.XX	Cerniera sfilabile con controp. in acc. inox Slip-of hinge with stainless steel counterplate	2	510.491.55	Tappo rotondo copriforo diametro 12 mm Circular coverhole plug dia. mm 12	5
2020(Mont.)	Squadretta Fuji allineamento aletta Fuji alignment corner joint on fin.	4	A.4003.ZX	Cremonese reversibile per ap. int. Reversible cremone bolt for internal opening	1	A.0225.EN	Angolo stampato per precamera Moulded corner for central weatherstrip	4
2013(Mont.)	Squadretta Fuji allineamento aletta Fuji alignment corner joint on fin.	8	504.091.05	Riscontro registrabile per puntali 404.145.05 Adjustable striker for terminals 404.145.05	2	502.002.XX	Angolo stampato per fermavetro arrotondato Moulded corner for snap-on rounded glass beading	4
2006(Mont)	Squadretta Fuji allineamento aletta prof. compl. Fuji alignment corner joint for coplanar profiles	4	509.261.55	Cappetta scarico acqua (paratempesta) Water drain cover	2	Comm.le	Tassello spessoramento vetro Shim for glasses	3
A.5441.AA	Squadretta per giunzione d'angolo Corner joint	8	410.405.01	Basetta unificata per regolo mobile Unified plate for adjustable block	5			

GUARNIZIONI
WEATHERSTRIPS

Articolo Item	Descrizione Description	N	Articolo Item	Descrizione Description	N	Articolo Item	Descrizione Description	N
G.0126.EN	Guarnizione di battuta Weatherstrip of rabbet	4H 3L	G.0139.RN	Guarnizione esterna appoggio vetri 1,5 mm Weatherstrip on glass support mm 1,5	2H 2L			
G.0129.EN	Guarnizione interna tenuta vetro 5-6 mm Weatherstrip on glazing bead shim mm 5-6	2H 2L	G.0120.EN	Guarnizione di precamera Central weatherstrip	2H 2L			

FINESTRA 2 ANTE
TWO-WINGS WINDOW

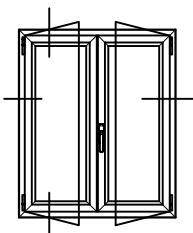

N.B: - Le dimensioni di taglio e di lavorazione indicate nelle pagine seguenti sono state ottenute considerando le quote teoriche.
Pertanto è necessario verificare sempre le dimensioni dei profilati prima di effettuare i tagli.
Sapa declina ogni responsabilità per errori dovuti al mancato controllo da parte del costruttore.

N.B: - The cutting and processing dimensions, indicated in the following pages, are obtained considering theoretical values.
It is, therefore, always necessary to check the dimensions of the profiles before executing the cutting.
Sapa declines any responsibility from errors caused from the missing dimensional check of the carpenter

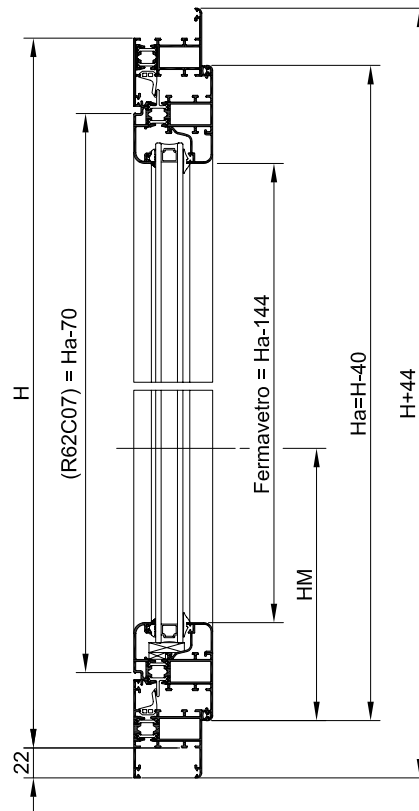
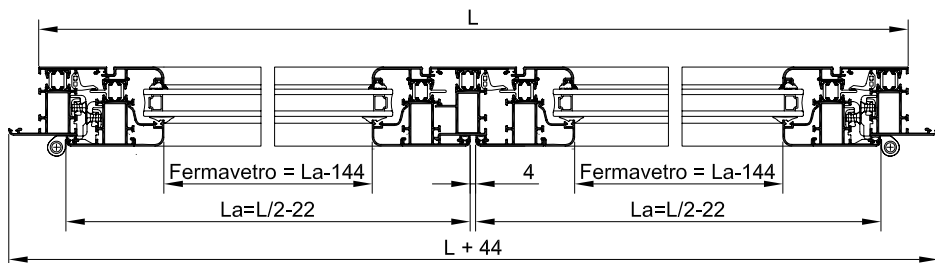

PROFILATI
SECTIONS

Profilato tipo Type Section	N° Pz.	Taglio Cut	N° Pz.	Taglio Cut
	2	 H + 44	1	 L + 44
			1	 L + 44
	4	 Ha = H - 40	4	 La = L/2 - 22
	4	 Ha - 144	4	 La - 144
	1	 Ha - 70		
	1	 (Inferiore/Lower) Hm - 113	1	 (Superiore/Upper) Ha - Hm - 113

DIMENSIONI VETRO
GLASS SIZE

N. 2 PEZZI	N.B.: Spessore vetro considerato 20 mm (4+12+4) Gioco perimetrale tra profilato e vetro 5 mm For glass with 20 mm thickness Space between glass and profile 5 mm
Ha - 110	
La - 110	

ACCESSORI
ACCESSORIES

Articolo Item	Descrizione Description	N	Articolo Item	Descrizione Description	N	Articolo Item	Descrizione Description	N
404.110.55	Innesti per cremonese su prof 900221 (cp) pair of coupling internal opening for 900221	1	401.002.XX	Cerniera sfilabile con controp.ra in acc. inox Slip-of hinge with stainless steel counterplate	4	509.261.55	Cappetta scarico acqua (paratempesta) Water drain cover	2
404.145.05	Puntali in zama su prof. 900221 (cp) Pair of zamak terminals on profile 900221	2	A.4003.ZX	Cremonese reversibile per ap. int. Reversible cremone bolt for internal opening	1	410.405.01	Basetta unificata per regolo mobile Unified plate for adjustable block	5
2020(Mont.)	Squadretta Fuji allineamento aletta Fuji alignment corner joint on fin.	4	Comm.le	Tassello spessoramento vetro Shim for glasses	6	510.415.01	Regolo mobile da 15 mm Adjustable block mm 15	5
2013(Mont.)	Squadretta Fuji allineamento aletta Fuji alignment corner joint on fin.	12	504.091.05	Riscontro registrabile per puntali 404.145.05 Adjustable striker for terminals 404.145.05	2	510.491.55	Tappo rotondo copriforo diametro 12 mm Circular coverhole plug dia. mm 12	5
2006(Mont)	Squadretta Fuji all.mento aletta prof. compl. Fuji alignment corner joint for coplanar profiles	8	A.2131.TN	Coppia tappi per riporto centrale R62C07 Pair of plugs for central rabbet on profile R62C07	1	A.0225.EN	Angolo stampato per precamera Moulded corner for central weatherstrip	4
A.5441.AA	Squadretta per giunzione d'angolo Corner joint	12	403.806.05	Manovra catenaccio per puntali 404.145.55 Lever deadlatch for terminals 404.145.55	2			
A.5662.AA	Squadretta a cianfrinare su prof. est. anta External corner joint to be crimped	8	502.002.XX	Angolo stampato per fermavetro arrotondato Moulded corner for snap-on rounded glass beading	8			

GUARNIZIONI
WEATHERSTRIPS

Articolo Item	Descrizione Description	N	Articolo Item	Descrizione Description	N	Articolo Item	Descrizione Description	N
G.0126.EN	Guarnizione di battuta Weatherstrip of rabbet	6H 3L	G.0139.RN	Guarnizione esterna appoggio vetri 1,5 mm Weatherstrip on glass support mm 1,5	4H 2L			
G.0129.EN	Guarnizione interna tenuta vetro 5-6 mm Weatherstrip on glazing bead shim mm 5-6	4H 2L	G.0120.EN	Guarnizione di precamera Central weatherstrip	3H 2L			

FINESTRA 1 ANTA A RIBALTA
TILT AND TURN WINDOW

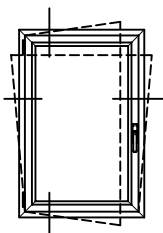

N.B.: - Le dimensioni di taglio e di lavorazione indicate nelle pagine seguenti sono state ottenute considerando le quote teoriche.
Pertanto è necessario verificare sempre le dimensioni dei profilati prima di effettuare i tagli.
Sapa declina ogni responsabilità per errori dovuti al mancato controllo da parte del costruttore.

N.B.: - The cutting and processing dimensions, indicated in the following pages, are obtained considering theoretical values.
It is, therefore, always necessary to check the dimensions of the profiles before executing the cutting.
Sapa declines any responsibility from errors caused from the missing dimensional check of the carpenter

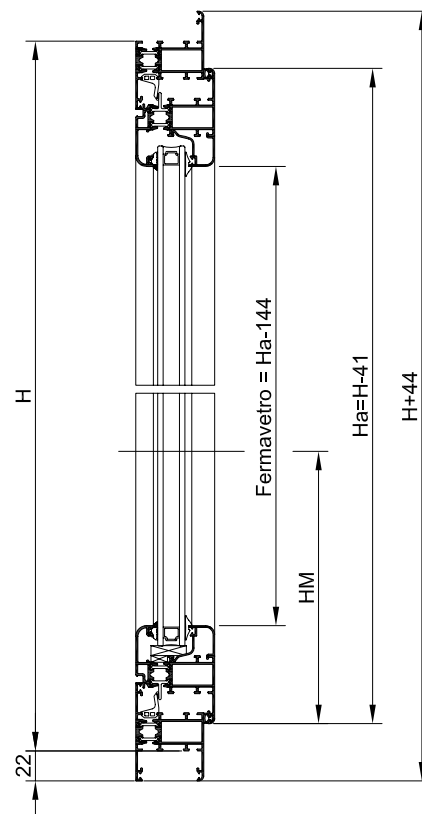
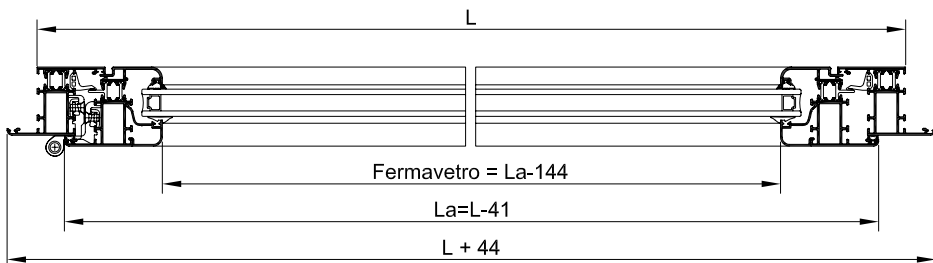

PROFILATI
SECTIONS

Profilato tipo Type Section	N° Pz.	Taglio Cut	N° Pz.	Taglio Cut
	2	H + 44	1	L + 44
			1	L + 44
	2	Ha = H - 41	2	La = L - 41
	2	Ha - 144	2	La - 144
	1	Verticale inferiore Lower Vertical Hm - 250 (*)	1	Verticale Superiore Upper Vertical Ha - Hm - 243 (*)
			1	Orizzontale Superiore Upper Horizontal La - 515 (*)

DIMENSIONI VETRO
GLASS SIZE

N. 1 PEZZO	N.B.: Spessore vetro considerato 20 mm (4+12+4) Gloco perimetrale tra profilato e vetro 5 mm For glass with 20 mm thickness Space between glass and profile 5 mm
Ha - 110	
La - 110	

(*) = Valido per ante con La da 550 a 1200 mm ed Ha fino a 2800 mm. Per altre dimensioni ed ulteriori informazioni Vi preghiamo di consultare lo schema di montaggio contenuto nella confezione AR.

This for wings with L from 550 to 1200 mm and H up to 2800 mm. For other dimensions and further information please see processing scheme inside A/R box

ACCESSORI
ACCESSORIES

Articolo Item	Descrizione Description	N	Articolo Item	Descrizione Description	N	Articolo Item	Descrizione Description	N
A. 1805.VX	Gruppo completo anta ribalta Tilt-and-turn kit	1	509.261.55	Cappetta scarico acqua (paratempesta) Water drain cover	2	Comm.le	Tassello spessoramento vetro Shim for glass	3
2020(Mont.)	Squadretta Fuji allineamento aletta Fuji alignment corner joint on fin.	4	410.405.01	Basetta unificata per regolo mobile Unified plate for adjustable block	5			
2013(Mont.)	Squadretta Fuji allineamento aletta Fuji alignment corner joint on fin.	8	510.415.01	Regolo mobile da 15 mm Adjustable block mm 15	5			
2006(Mont)	Squadretta Fuji all.mento aletta prof. compl. Fuji alignment corner joint for coplanar profiles	4	510.491.55	Tappo rotondo copriforo diametro 12 mm Circular coverhole plug dia. mm 12	5			
A. 5441.AA	Squadretta per giunzione d'angolo Corner joint	8	A.0225.EN	Angolo stampato per precamera Moulded corner for central weatherstrip	4			
A. 5662.AA	Squadretta a cianfrinare su prof. est. anta External corner joint to be crimped	4	502.002.XX	Angolo stampato per fermavetro arrotondato Moulded corner for snap-on rounded glass beading	4			

GUARNIZIONI
WEATHERSTRIPS

Articolo Item	Descrizione Description	N	Articolo Item	Descrizione Description	N	Articolo Item	Descrizione Description	N
G.0126.EN	Guarnizione di battuta Weatherstrip of rabbet	4H 3L	G.0139.RN	Guarnizione esterna appoggio vetri 1,5 mm Weatherstrip on glass support mm 1.5	2H 2L			
G.0129.EN	Guarnizione interna tenuta vetro 5-6 mm Weatherstrip on glazing bead shim mm 5-6	2H 2L	G.0120.EN	Guarnizione di precamera Central weatherstrip	2H 2L			

FINESTRA 2 ANTE
CON ANTA RIBALTA
WING WINDOW - OVERLAP
AND TILT-AND-TURN

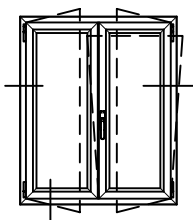

N.B.: - Le dimensioni di taglio e di lavorazione indicate nelle pagine seguenti sono state ottenute considerando le quote teoriche.
Pertanto è necessario verificare sempre le dimensioni dei profilati prima di effettuare i tagli.
Sapa declina ogni responsabilità per errori dovuti al mancato controllo da parte del costruttore.

N.B.: - The cutting and processing dimensions, indicated in the following pages, are obtained considering theoretical values.
It is, therefore, always necessary to check the dimensions of the profiles before executing the cutting.
Sapa declines any responsibility from errors caused from the missing dimensional check of the carpenter

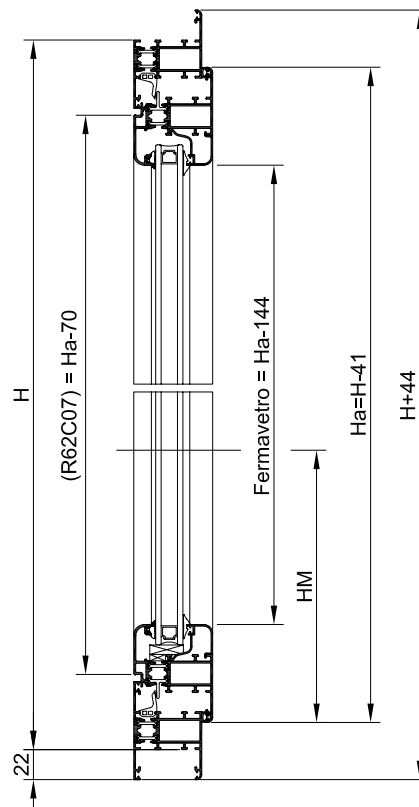
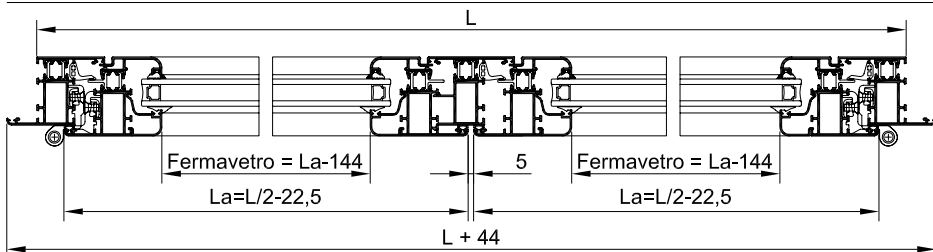

PROFILATI
SECTIONS

Profilato tipo Type Section	N° Pz.	Taglio Cut	N° Pz.	Taglio Cut
	2	 H + 44	1	 L + 44
			1	 L + 44
	4	 Ha = H - 41	4	 La = L/2 - 22,5
	4	 Ha - 144	4	 La - 144
	1	 Ha - 70		
	1	Verticale inferiore Lower Vertical Hm - 250 (*)	1	Verticale Superiore Upper Vertical Ha - Hm - 243 (*)
			1	Orizzontale Superiore Upper Orizzontale La - 515 (*)

(*) = Valido per ante con La da 550 a 1200 mm ed Ha fino a 2800 mm. Per altre dimensioni ed ulteriori informazioni Vi preghiamo di consultare lo schema di montaggio contenuto nella confezione AR.

This for wings with L from 550 to 1200 mm and H up to 2800 mm. For other dimensions and further information please see processing scheme inside AR box

DIMENSIONI VETRO
GLASS SIZE

N. 2 PEZZI	N.B.: Spessore vetro considerato 20 mm (4+12+4) Gioco perimetrale tra profilato e vetro 5 mm For glass with 20 mm thickness Space between glass and profile 5 mm
Ha - 110	
La - 110	

ACCESSORI
ACCESSORIES

Articolo Item	Descrizione Description	N	Articolo Item	Descrizione Description	N	Articolo Item	Descrizione Description	N
A.1805.VX	Kit cerniere anta affiancata A/R Kit hinges for side by side leaf	1	A.5662.AA	Squadretta a cianfrinare su prof. est. anta External corner joint to be crimped	8	510.491.55	Tappo rotondo copriforo diametro 12 mm Circular coverhole plug dia. mm 12	5
A.1810.VV	Paletti per anta semifissa A/R (cp) Straight latches for semifixed wing (pair)	1	A.5441.AA	Squadretta per giunzione d'angolo Corner joint	12	A.0225.EN	Angolo stampato per precamera Moulded corner for central weatherstrip	4
A.1809.VX	Gruppo completo anta ribalta Tilt-and-turn kit	1	A.2131.TN	Coppia tappi per riporto centrale R62C07 Pair of plugs for central rabbet on profile R62C07	1	502.002.XX	Angolo stampato per fermavetro arrotondato Moulded corner for snap-on rounded glass beading	8
2020(Mont.)	Squadretta Fuji allineamento aletta Fuji alignment corner joint on fin.	4	509.261.55	Cappetta scarico acqua (paratempesta) Water drain cover	2	Comm.le	Tassello spessoramento vetri Shim for glasses	6
2013(Mont.)	Squadretta Fuji allineamento aletta Fuji alignment corner joint on fin.	12	410.405.01	Basetta unificata per regolo mobile Unified plate for adjustable block	5			
2006(Mont.)	Squadretta Fuji all.mento aletta prof. compl. Fuji alignment corner joint for coplanar profiles	8	510.415.01	Regolo mobile da 15 mm Adjustable block mm 15	5			

GUARNIZIONI
WEATHERSTRIPS

Articolo Item	Descrizione Description	N	Articolo Item	Descrizione Description	N	Articolo Item	Descrizione Description	N
G.0126.EN	Guarnizione di battuta Weatherstrip of rabbet	6H 3L	G.0139.RN	Guarnizione esterna appoggio vetri 1,5 mm Weatherstrip on glass support mm 1,5	4H 2L			
G.0129.EN	Guarnizione interna tenuta vetro 5-6 mm Weatherstrip on glazing bead shim mm 5-6	4H 2L	G.0120.EN	Guarnizione di precamera Central weatherstrip	3H 2L			

FINESTRA SPORGERE
PROJECTING WINDOW

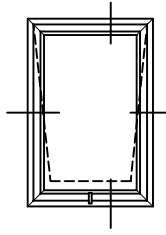

N.B.: - Le dimensioni di taglio e di lavorazione indicate nelle pagine seguenti sono state ottenute considerando le quote teoriche.
Pertanto è necessario verificare sempre le dimensioni dei profilati prima di effettuare i tagli.
Sapa declina ogni responsabilità per errori dovuti al mancato controllo da parte del costruttore.

N.B.: - The cutting and processing dimensions, indicated in the following pages, are obtained considering theoretical values.
It is, therefore, always necessary to check the dimensions of the profiles before executing the cutting.
Sapa declines any responsibility from errors caused from the missing dimensional check of the carpenter

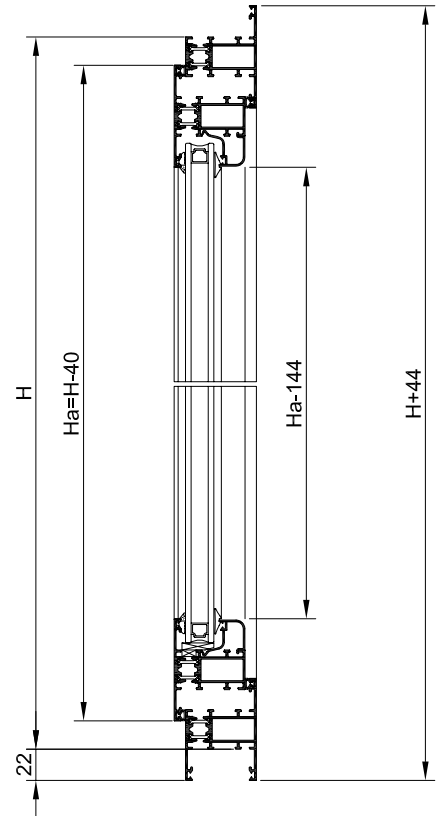
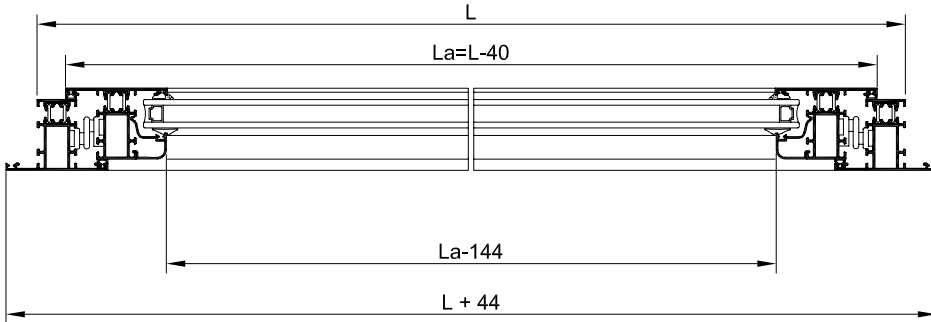

PROFILATI
SECTIONS

Profilato tipo Type Section	N° Pz.	Taglio Cut	N° Pz.	Taglio Cut
	2	 H + 44	1	 L + 44
			1	 L + 44
	2	 Ha = H - 40	2	 La = L - 40
	2	 Ha - 144	2	 La - 144

DIMENSIONI VETRO
GLASS SIZE

N. 1 PEZZO	N.B.: Spessore vetro considerato 20 mm (4+12+4) Gloco perimetrale tra profilato e vetro 5 mm For glass with 20 mm thickness Space between glass and profile 5 mm
Ha - 110	
La - 110	

ACCESSORI
ACCESSORIES

Articolo Item	Descrizione Description	N	Articolo Item	Descrizione Description	N	Articolo Item	Descrizione Description	N
406.499.05	Gruppo articolazione sporgere con bracci Kit for stiffened projecting windows with arms	1	510.415.01	Regolo mobile da 15 mm Adjustable block mm 15	5			
503.963.xx	Maniglia a tavellino "linea 600" "600 flatcatch" handle for projecting windows	1	510.491.55	Tappo rotondo copriforo diametro 12 mm Circular coverhole plug dia. mm 12	5			
2020(Mont.)	Squadretta Fuji allineamento aletta Fuji alignment corner joint on fin.	8	502.002.XX	Angolo stampato per fermavetro arrotondato Moulded corner for snap-on rounded glass beading	4			
2013(Mont.)	Squadretta Fuji allineamento aletta Fuji alignment corner joint on fin.	8	Comm.le	Tassello spessoramento vetro Shim for glass	3			
A.5441.AA	Squadretta per giunzione d'angolo Corner joint	8						
410.405.01	Basetta unificata per regolo mobile Unified plate for adjustable block	5						

GUARNIZIONI
WEATHERSTRIPS

Articolo Item	Descrizione Description	N	Articolo Item	Descrizione Description	N	Articolo Item	Descrizione Description	N
G.0126.EN	Guarnizione di battuta Weatherstrip of rabbet	6H 5L	G.0139.RN	Guarnizione esterna appoggio vetri 1,5 mm Weatherstrip on glass support mm 1,5	2H 2L			
G.0129.EN	Guarnizione interna tenuta vetro 5-6 mm Weatherstrip on glazing bead shim mm 5-6	2H 2L						

FINESTRA VASISTAS
OVERLAP HOPPER WINDOW

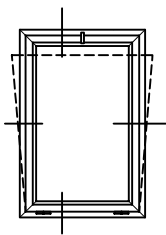

N.B: - Le dimensioni di taglio e di lavorazione indicate nelle pagine seguenti sono state ottenute considerando le quote teoriche.
Pertanto è necessario verificare sempre le dimensioni dei profilati prima di effettuare i tagli.
Sapa declina ogni responsabilità per errori dovuti al mancato controllo da parte del costruttore.

N.B: - The cutting and processing dimensions, indicated in the following pages, are obtained considering theoretical values.
It is, therefore, always necessary to check the dimensions of the profiles before executing the cutting.
Sapa declines any responsibility from errors caused from the missing dimensional check of the carpenter

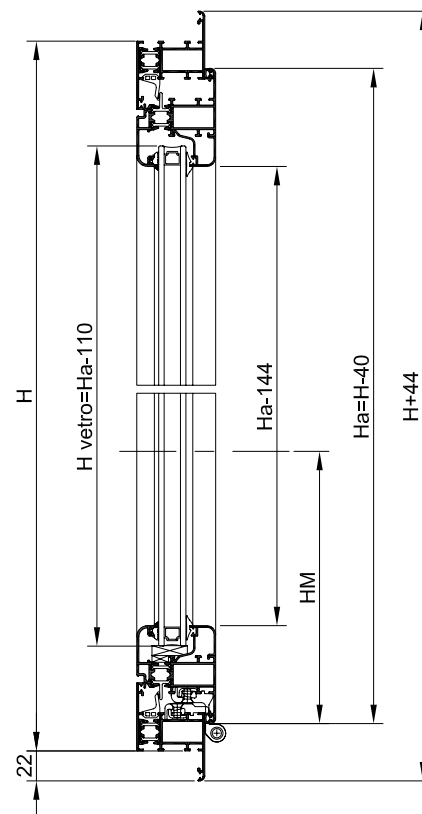
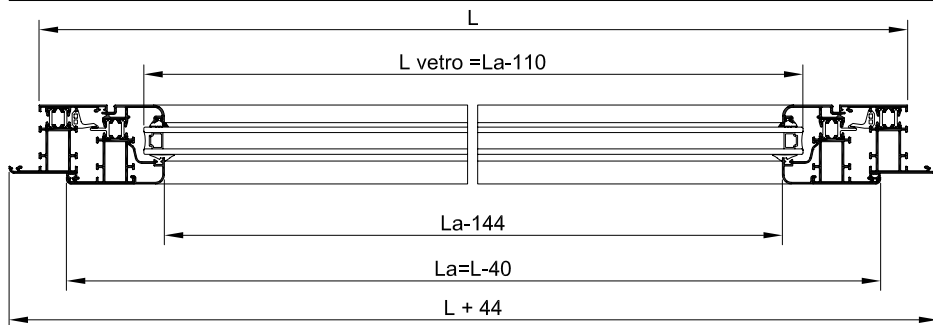

PROFILATI
SECTIONS

Profilato tipo Type Section	N° Pz.	Taglio Cut	N° Pz.	Taglio Cut
	2	 H + 44	2	 L + 44
	2	 Ha= H - 40	2	 La= L - 40
	2	 Ha - 144	2	 La - 144

DIMENSIONI VETRO
GLASS SIZE

N. 1 PEZZO	N.B.: Spessore vetro considerato 20 mm (4+12+4) Glco perimetrale tra profilato e vetro 5 mm For glass with 20 mm thickness Space between glass and profile 5 mm
Ha - 110	
La - 110	

ACCESSORI
ACCESSORIES

Articolo Item	Descrizione Description	N	Articolo Item	Descrizione Description	N	Articolo Item	Descrizione Description	N
A.3906.IA	coppia bracci per vasistas pair of coupling internal opening for 900221	1	A.5441.AA	Squadretta per giunzione d'angolo Corner joint	8	A.0225.EN	Angolo stampato per precamera Moulded corner for central weatherstrip	4
401.002.xx	Cerniera sfilabile con controp.ra in acc. inox Slip-of hinge with stainless steel counterplate	2	Comm.le	Tassello spessoramento vetro Shim for glass	3	502.002.XX	Angolo stampato per fermavetro arrotondato Moulded corner for snap-on rounded glass beading	4
503.642.xx	Chiusura a cricchetto Spring latch locking	1	509.261.55	Cappetta scarico acqua (paratempsta) Water drain cover	2			
2020(Mont.)	Squadretta Fuji allineamento aletta Fuji alignment corner joint on fin.	4	410.405.01	Basetta unificata per regolo mobile Unified plate for adjustable block	5			
2013(Mont.)	Squadretta Fuji allineamento aletta Fuji alignment corner joint on fin.	8	510.415.01	Regolo mobile da 15 mm Adjustable block mm 15	5			
2006(Mont)	Squadretta Fuji all.mento aletta prof. compl. Fuji alignment corner joint for coplanar profiles	4	510.491.55	Tappo rotondo copriforo diametro 12 mm Circular coverhole plug dia. mm 12	5			

GUARNIZIONI
WEATHERSTRIPS

Articolo Item	Descrizione Description	N	Articolo Item	Descrizione Description	N	Articolo Item	Descrizione Description	N
G.0126.EN	Guarnizione di battuta Weatherstrip of rabbet	4H 3L	G.0139.RN	Guarnizione esterna appoggio vetri 1,5 mm Weatherstrip on glass support mm 1.5	2H 2L			
G.0129.EN	Guarnizione interna tenuta vetro 5-6 mm Weatherstrip on glazing bead shim mm 5-6	2H 2L	G.0120.EN	Guarnizione di precamera Central weatherstrip	2H 2L			

PORTA
BALCONE 1 ANTA
ONE-WING
BALCONY DOOR

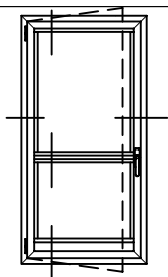

N.B: - Le dimensioni di taglio e di lavorazione indicate nelle pagine seguenti sono state ottenute considerando le quote teoriche.
Pertanto è necessario verificare sempre le dimensioni dei profilati prima di effettuare i tagli.
Sapa declina ogni responsabilità per errori dovuti al mancato controllo da parte del costruttore.

N.B: - The cutting and processing dimensions, indicated in the following pages, are obtained considering theoretical values.
It is, therefore, always necessary to check the dimensions of the profiles before executing the cutting.
Sapa declines any responsibility from errors caused from the missing dimensional check of the carpenter

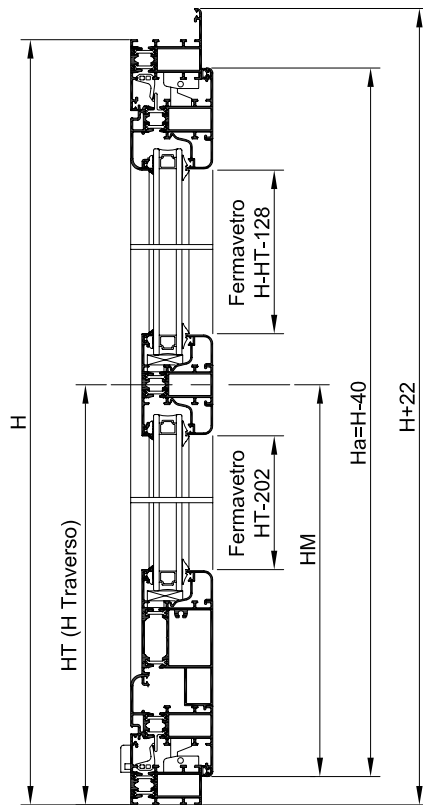
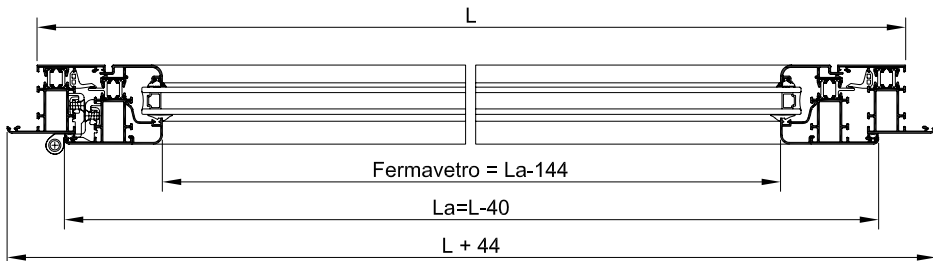

PROFILATI
SECTIONS

Profilato tipo Type Section	N° Pz.	Taglio Cut	N° Pz.	Taglio Cut
	1		1	
	1			
			1	
	2		2	
			1	
			1	
	2		2	
	1		1	
			4	

DIMENSIONE VETRO
GLASS SIZE

N. 1 PEZZO	N.B.: Spessore vetro considerato 20 mm (4+12+4)
HT - 168	Gloco perimetrale tra profilato e vetro 5 mm
La - 110	For glass with 20 mm thickness
N. 1 PEZZO	Space between glass and profile 5 mm
H - HT - 94	
La - 110	

ACCESSORI
ACCESSORIES

Articolo Item	Descrizione Description	N	Articolo Item	Descrizione Description	N	Articolo Item	Descrizione Description	N
404.110.55	Innesti per cremonese su prof 900221(cp) Pair of coupling internal opening for 900221	1	A.5662.AA	Squadretta a cianfrinare su prof. est. anta External corner joint to be crimped	4	510.415.01	Regolo mobile da 15 mm Adjustable block mm 15	8
404.145.05	Puntali in zama su prof. 900221 (cp) Pair of zamak terminals on profile 900221	1	505.267.01	Giunto in alluminio estruso Extruded aluminium joint	2	510.491.55	Tappo rotondo copriforo diametro 12 mm Circular coverhole plug dia. mm 12	8
2020(Mont.)	Squadretta Fuji allineamento aletta Fuji alignment corner joint on fin.	4	A.4003.ZX	Cremonese reversibile per ap. int. Reversible cremone bolt for internal opening	1	A.0225.EN	Angolo stampato per precamera Moulded corner for central weatherstrip	4
2013(Mont.)	Squadretta Fuji allineamento aletta Fuji alignment corner joint on fin.	6	504.091.05	Riscontro registrabile per puntali 404.145.05 Adjustable striker for terminals 404.145.05	2	502.002.XX	Angolo stampato per fermavetro arrotondato Moulded corner for snap-on rounded glass beading	8
2006(Mont.)	Squadretta Fuji allineamento aletta prof. compl. Fuji alignment corner joint for coplanar profiles	4	509.261.55	Cappetta scarico acqua (paratempesta) Water drain cover	2	401.002.XX	Cerniera sfilabile con controp. in acc. inox Slip-of-hinge with stainless steel counterplate	3
A.5441.AA	Squadretta per giunzione d'angolo Corner joint	8	410.405.01	Basetta unificata per regolo mobile Unified plate for adjustable block	8	Comm.le	Tassello spessoramento vetri Shim for glasses	6
			A.3204.ZA	Cavallotto di giunzione tela-traversi Tjoint for frames and transoms	6			

GUARNIZIONI
WEATHERSTRIPS

Articolo Item	Descrizione Description	N	Articolo Item	Descrizione Description	N	Articolo Item	Descrizione Description	N
G.0126.EN	Guarnizione di battuta Weatherstrip of rabbet	4H 3L	G.0139.RN	Guarnizione esterna appoggio vetri 1,5 mm Weatherstrip on glass support mm 1,5	2H 4L			
G.0129.EN	Guarnizione interna tenuta vetro 5-6 mm Weatherstrip on glazing bead shim mm 5-6	2H 4L	G.0120.EN	Guarnizione di precamera Central weatherstrip	2H 2L			

PORTA
BALCONE 2 ANTE
TWO-WINGS
BALCONY DOOR

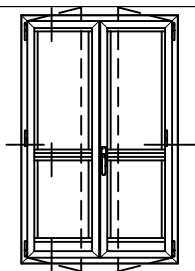

N.B: - Le dimensioni di taglio e di lavorazione indicate nelle pagine seguenti sono state ottenute considerando le quote teoriche.
Pertanto è necessario verificare sempre le dimensioni dei profilati prima di effettuare i tagli.
Sapa declina ogni responsabilità per errori dovuti al mancato controllo da parte del costruttore.

N.B: - The cutting and processing dimensions, indicated in the following pages, are obtained considering theoretical values.
It is, therefore, always necessary to check the dimensions of the profiles before executing the cutting.
Sapa declines any responsibility from errors caused from the missing dimensional check of the carpenter

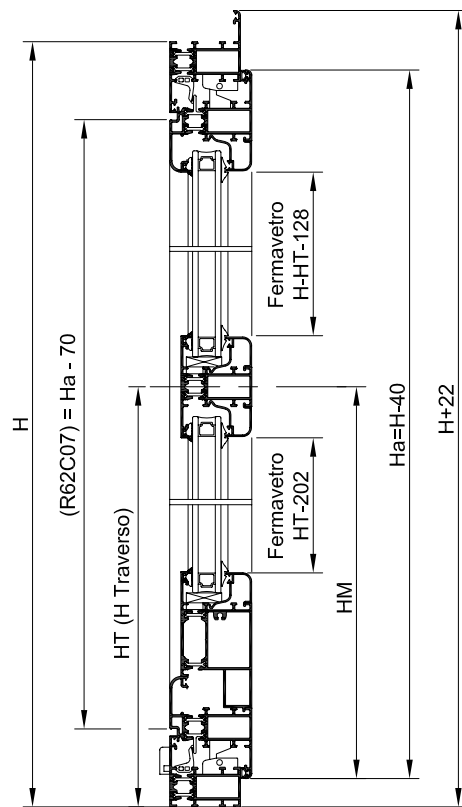
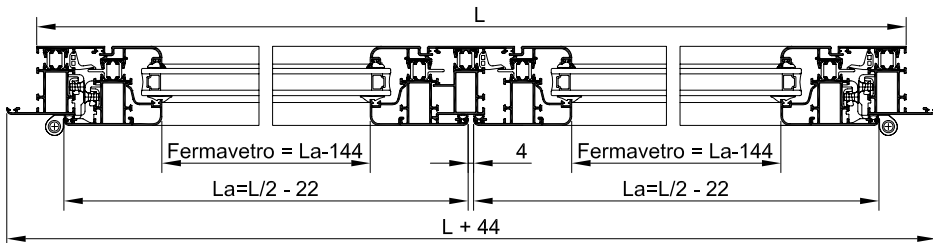

PROFILATI
SECTIONS

Profilato tipo Type Section	N° Pz.	Taglio Cut	N° Pz.	Taglio Cut
	1	H + 44	1	L + 44
	1	H + 44	1	L + 44
			1	L
	4	Ha= H - 40	4	La= L/2 - 22
			2	La - 91
			2	La - 91
	1	Ha - 70		
	4	H-HT-128	4	HT-202
	1	(Inferiore/Lower) Hm - 113	1	(Superiore/Upper) Ha - Hm - 113

DIMENSIONE VETRO
GLASS SIZE

N. 2 PEZZI	N.B.: Spessore vetro considerato 20 mm (4+12+4) Gioco perimetrale tra profilato e vetro 5 mm For glass with 20 mm thickness Space between glass and profile 5 mm
HT - 168	
La - 110	
N. 2 PEZZI	
H - HT - 94	
La - 110	

ACCESSORI
ACCESSORIES

Articolo Item	Descrizione Description	N	Articolo Item	Descrizione Description	N	Articolo Item	Descrizione Description	N
404.110.55	Innesti per cremonese su prof 900221(cp) Pair of coupling internal opening for 900221	1	A.5662.AA	Squadretta a cianfrinare su prof. est. anta External corner joint to be crimped	8	403.806.05	Manovra catenaccio per puntali 404.145.55 Lever deadlatch for terminals 404.145.55	2
404.145.05	Puntali in zama su prof. 900221 (cp) Pair of zamak terminals on profile 900221	2	505.267.01	Giunto in alluminio estruso Extruded aluminium joint	2	509.261.55	Cappetta scarico acqua (paratempesta) Water drain cover	2
2020(Mont.)	Squadretta Fuji allineamento aletta Fuji alignment corner joint on fin.	4	401.002.xx	Cerniera sfilabile con controp.ra in acc. inox Slip-of hinge with stainless steel counterplate	6	410.405.01	Basetta unificata per regolo mobile Unified plate for adjustable block	8
2013(Mont.)	Squadretta Fuji allineamento aletta Fuji alignment corner joint on fin.	10	A.4003.ZX	Cremonese reversibile per ap. int. Reversible cremone bolt for internal opening	1	510.415.01	Regolo mobile da 15 mm Adjustable block mm 15	8
2006(Mont.)	Squadretta Fuji all.mento aletta prof. compl. Fuji alignment corner joint for coplanar profiles	8	504.091.05	Riscontro registrabile per puntali 404.145.05 Adjustable striker for terminals 404.145.05	2	510.491.55	Tappo rotondo copriforo diametro 12 mm Circular coverhole plug dia. mm 12	8
A.5441.AA	Squadretta per giunzione d'angolo Corner joint	12	A.2131.TN	Coppia tappi per riporto centrale R62C07 Pair of plugs for central rabbet on profile R62C07	1	A.0225.EN	Angolo stampato per precamera Moulded corner for central weatherstrip	4
			502.002.XX	Angolo stampato per fermavetro arrotondato Moulded corner for snap-on rounded glass beading	16	Comm.le	Tassello spessoramento vetri Shim for glasses	6
			A.3204.ZA	Cavallotto di giunzione telai-traversi Tjoint for frames and transoms	12			

GUARNIZIONI
WEATHERSTRIPS

Articolo Item	Descrizione Description	N	Articolo Item	Descrizione Description	N	Articolo Item	Descrizione Description	N
G.0126.EN	Guarnizione di battuta Weatherstrip of rabbet	6H 3L	G.0139.RN	Guarnizione esterna appoggio vetri 1,5 mm Weatherstrip on glass support mm 1.5	4H 4L			
G.0129.EN	Guarnizione interna tenuta vetro 5-6 mm Weatherstrip on glazing bead shim mm 5-6	4H 4L	G.0120.EN	Guarnizione di precamera Central weatherstrip	3H 2L			

SQUADRETTA D'ANGOLO
CORNER JOINT

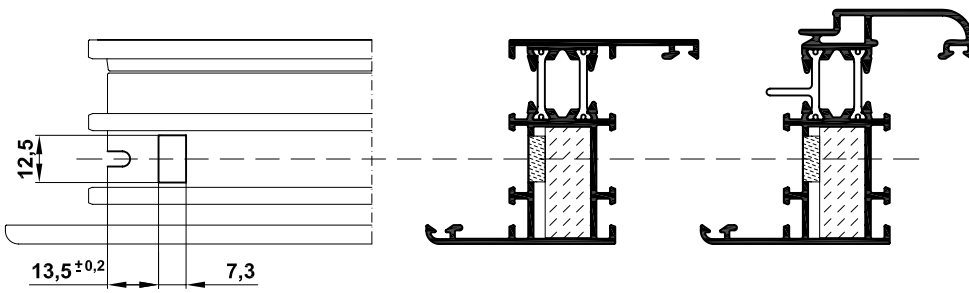

ART. : A.5441.AA



Attrezzatura: PUNZONATRICE
Tooling: PUNCHING MACHINE

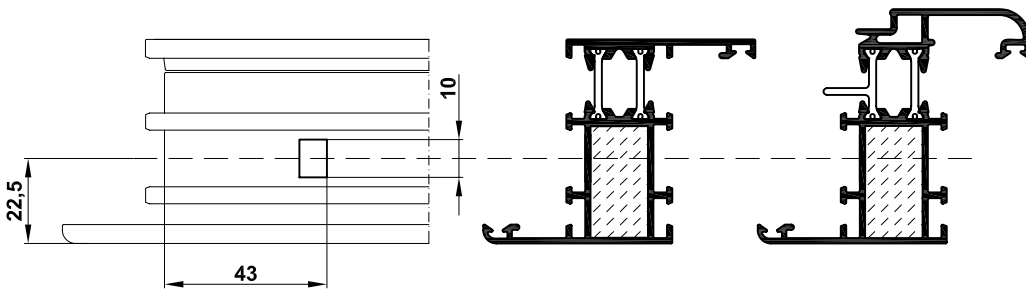

ART. : 5034



Attrezzatura: CIANFRINATRICE MANUALE
Tooling: MANUAL CRIMPING TOOL

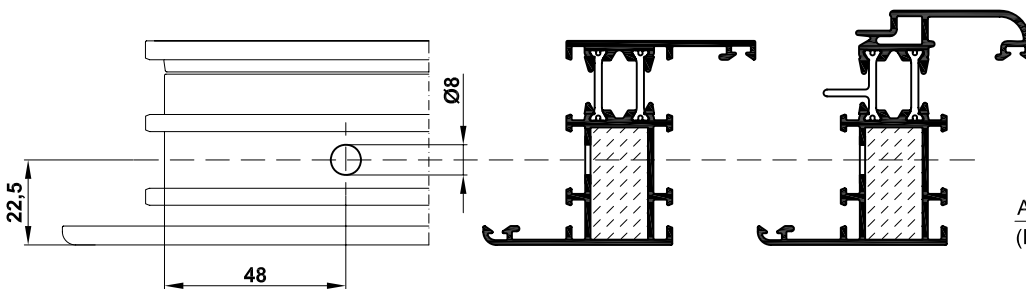

ART. : 5034



ART. : VILM 5x14_D8
(Monticelli)

Attrezzatura: TRAPANO
Tooling: DRILL

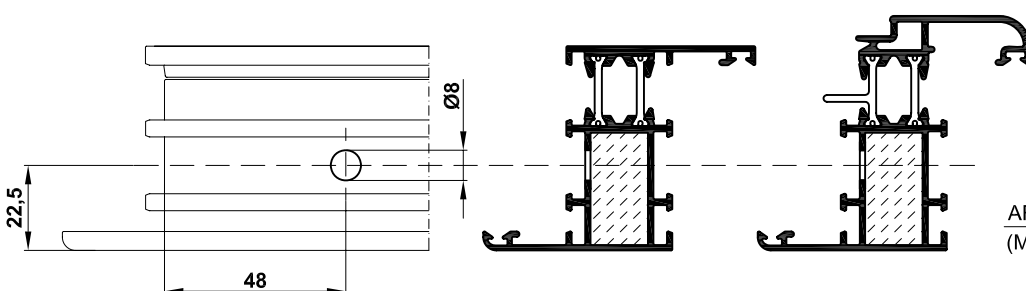

ART. : 5034



ART. : VILM 5x14_0088
(Monticelli)

Attrezzatura: TRAPANO
Tooling: DRILL

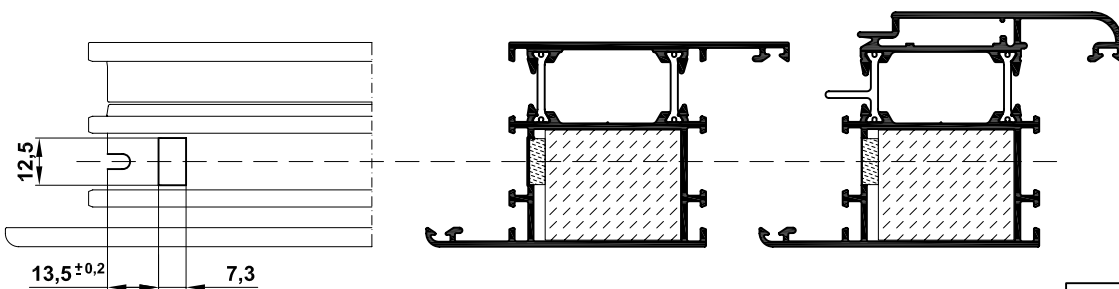

ART. : A.5429.AA



Attrezzatura: PUNZONATRICE
Tooling: PUNCHING MACHINE

SQUADRETTA D'ANGOLO
CORNER JOINT

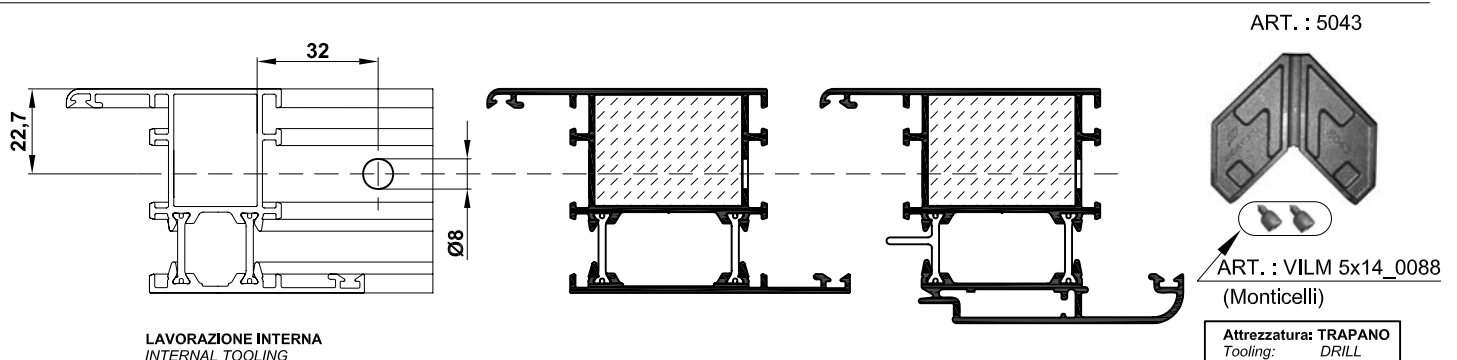
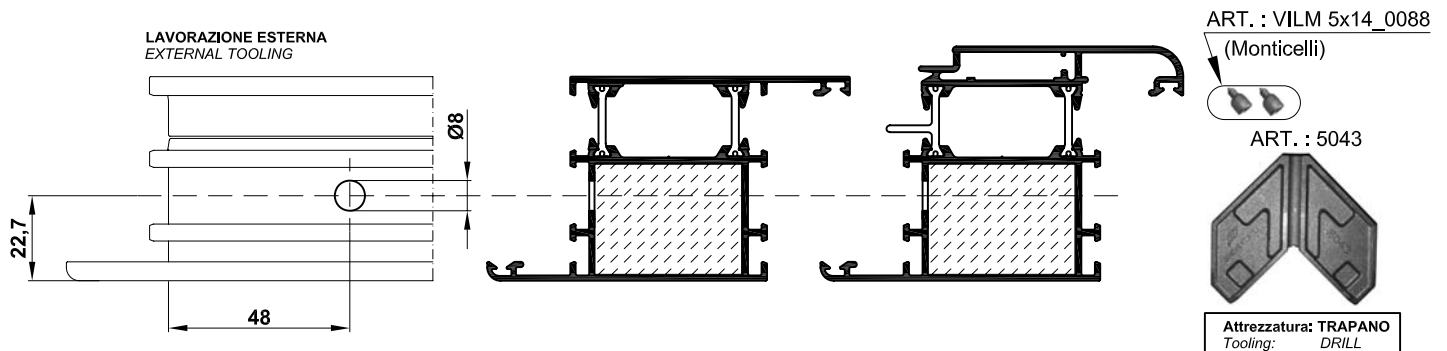
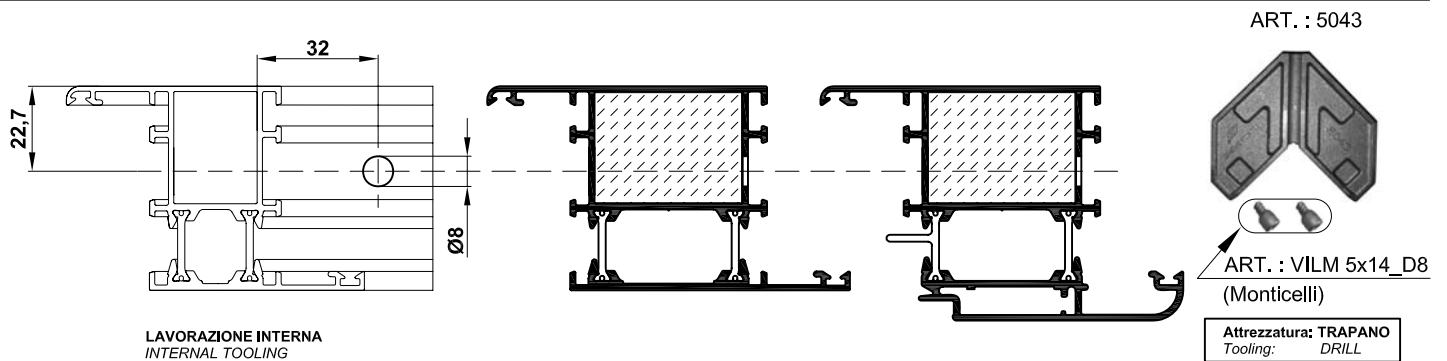
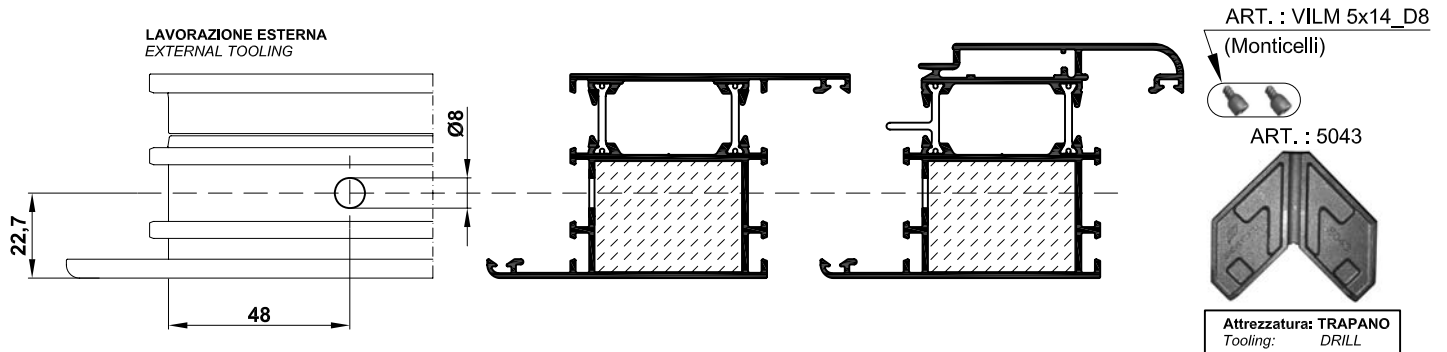
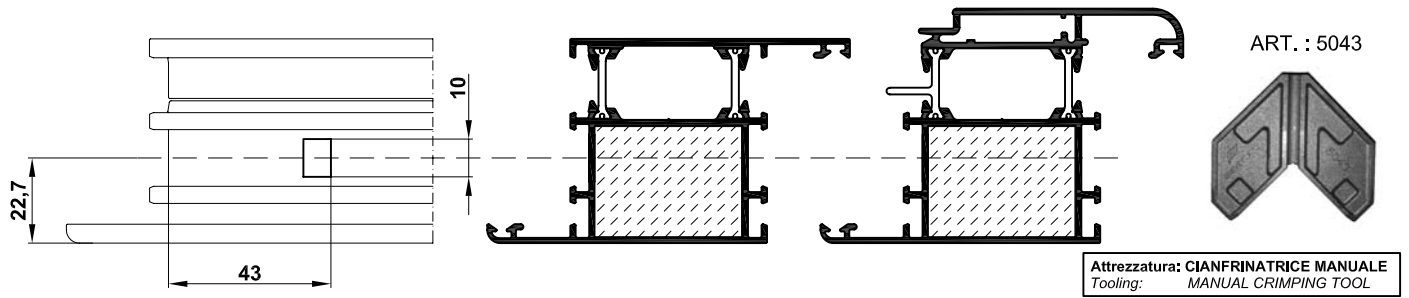

SQUADRETTA D'ANGOLO
CORNER JOINT

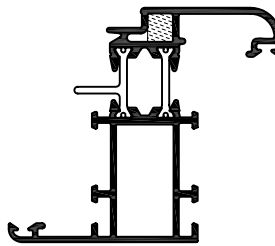
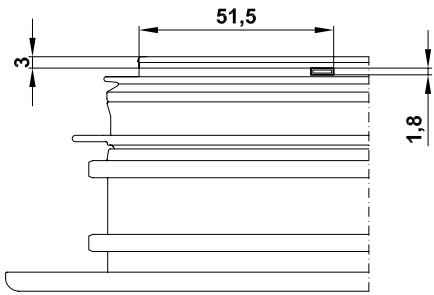

Per Profilati:
R62C06
R62C19
R62C44
R62C47
R62C66
R62C113

ART. : A.5662.AA



Attrezzatura: CIANFRINATRICE MANUALE
Tooling: MANUAL CRIMPING TOOL

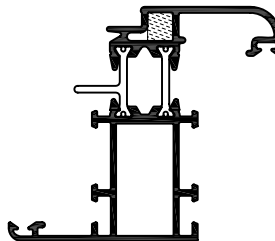
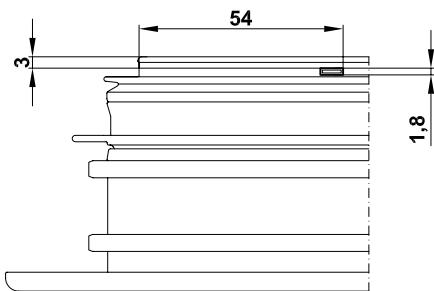

Per Profilati:
R62C06
R62C19
R62C44
R62C47
R62C66
R62C113

ART. : 0133



Attrezzatura: CIANFRINATRICE MANUALE
Tooling: MANUAL CRIMPING TOOL

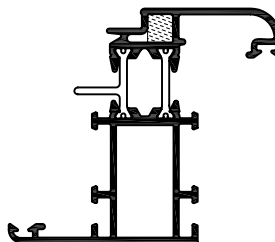
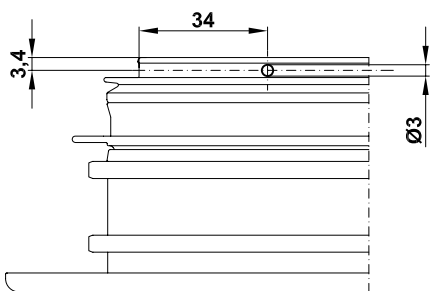

Per Profilati:
R62C06
R62C19
R62C44
R62C47
R62C66
R62C113

ART. : 0133



Spina 0092 "Moticelli"



Attrezzatura: TRAPANO
Tooling: DRILL

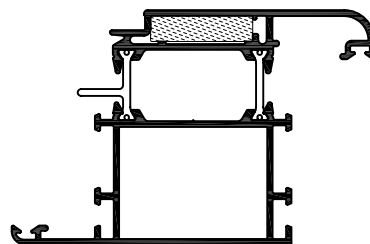
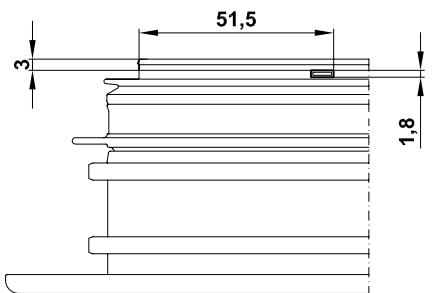

Per Profilati:
R62C17
R62C37
R62C57
R62C60
R62C68
R62C69

ART. : A.5624.AA



Attrezzatura: CIANFRINATRICE MANUALE
Tooling: MANUAL CRIMPING TOOL

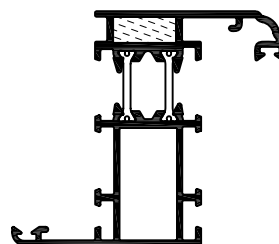
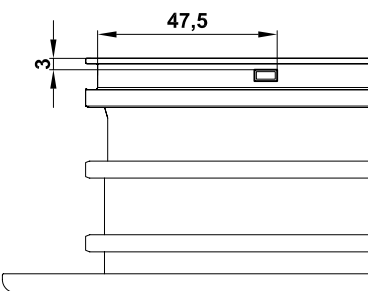

R62C46

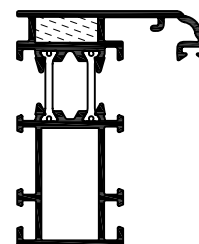

R62C45

ART. : A.2921.AA



Attrezzatura: CIANFRINATRICE MANUALE
Tooling: MANUAL CRIMPING TOOL

SQUADRETTA D'ANGOLO
CORNER JOINT

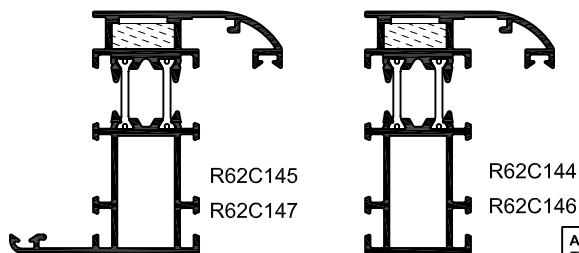
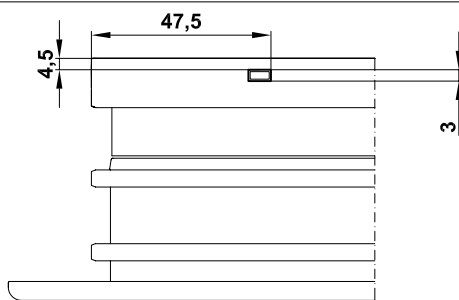

ART. : A.2921.AA



Attrezzatura: CIANFRINATRICE MANUALE
Tooling: MANUAL CRIMPING TOOL

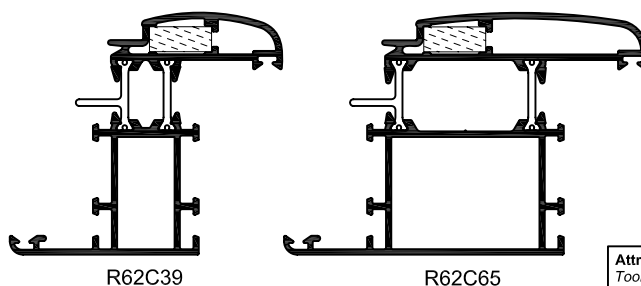
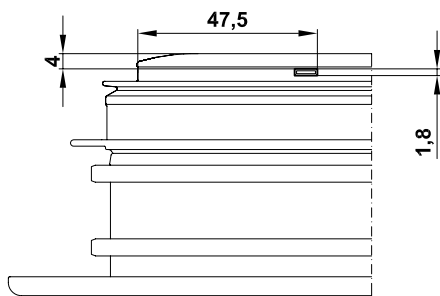

ART. : A.2921.AA



Attrezzatura: CIANFRINATRICE MANUALE
Tooling: MANUAL CRIMPING TOOL

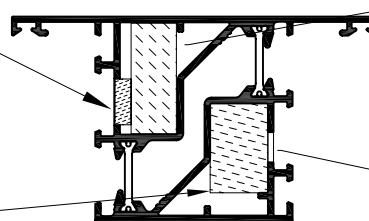
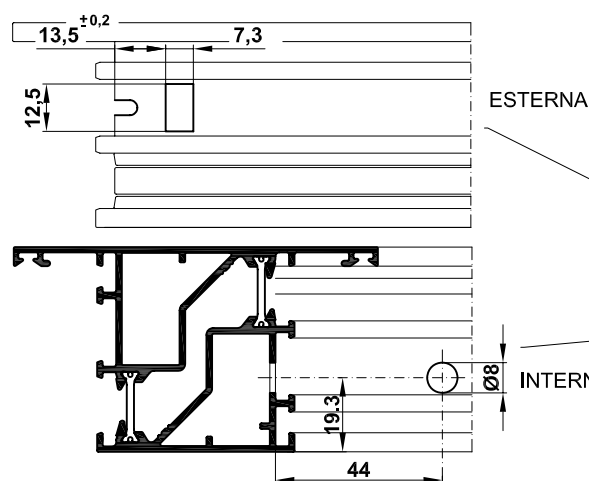

ART. : A.5441.AA



Attrezzatura: PUNZONATRICE
Tooling: PUNCHING MACHINE

ART. : 5033

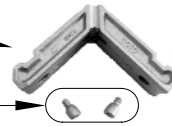

ART. : VILM 5x14_D8
(Monticelli)

Attrezzatura: TRAPANO
Tooling: DRILL

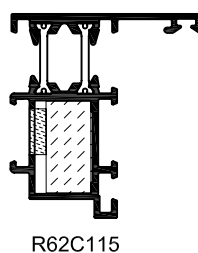
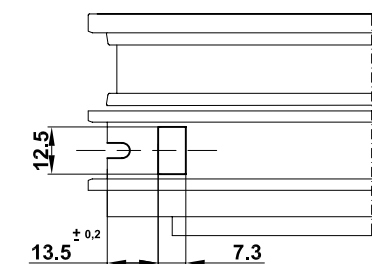

A.2915.AA



Attrezzatura: PUNZONATRICE
Tooling: PUNCHING MACHINE

ASPORTAZIONE DENTINI PER INSERIMENTO ASTA
TOOTH REMOVAL FOR ROD NOTCH

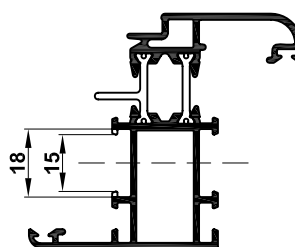
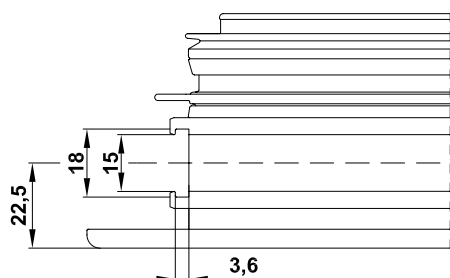

900221

Attrezzatura: PUNZONATRICE
Tooling: PUNCHING MACHINE

APPLICAZIONE SQUADRETTE DI ALLINEAMENTO
ALIGNMENT CORNER JOINTS APPLICATION

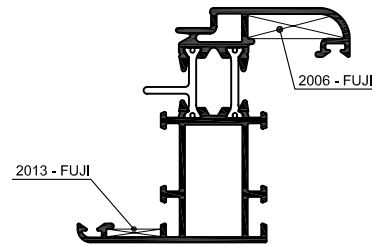
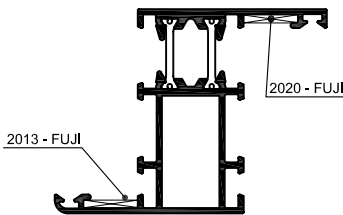
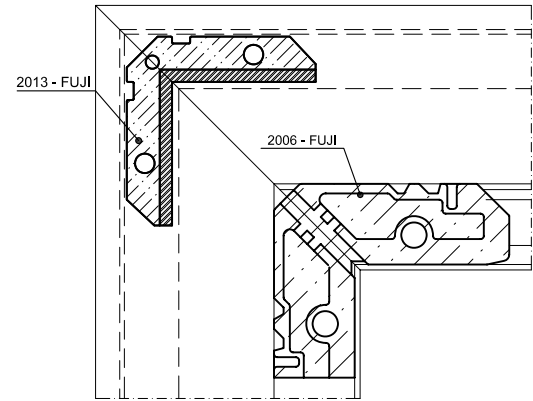
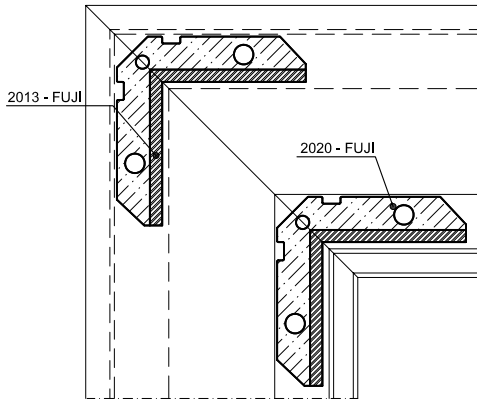

- Le squadrette di allineamento su alette, devono essere incollate con colle per alluminio di tipo epossidico bicomponente o di tipo poliuretano monocomponente

- The corner joints to be crimped, and alignment on fins, must be glued with bicomponent epoxy or monocomponent polyuretan glue for aluminium

INTESTATURA FASCE E ZOCOLI PER TELAI
BUTTING HORIZONTAL PANELS - SKIRTING BOARDS FOR FRAMES

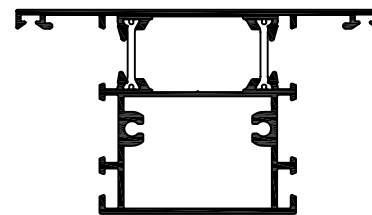
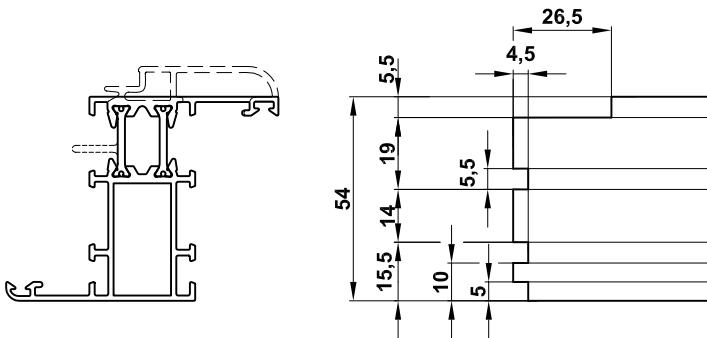

R62C10
R62C11
R62C15
R62C18
R62C33
R62C121
R62C122

Attrezzatura: GRUPPO FRESE
Tooling: MILLING CUTTER GROUP

INTESTATURA FASCE E ZOCOLI PER ANTE COMPLANARI
BUTTING HORIZONTAL PANELS - SKIRTING BOARDS FOR COMPLANAR WINGS

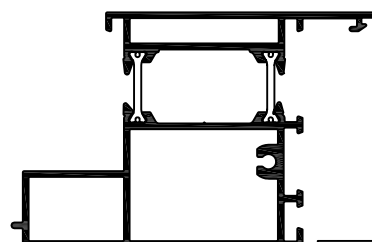
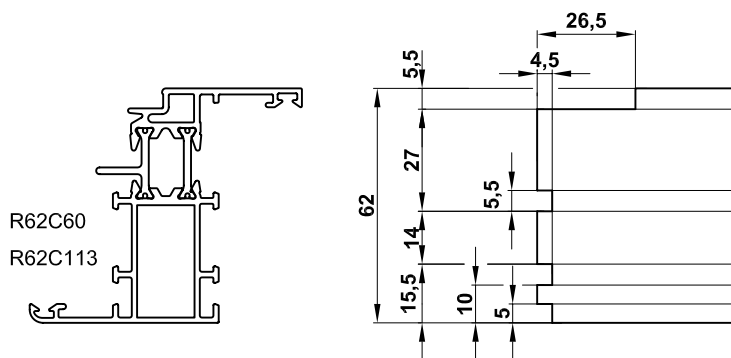

R62C60
R62C113

R62C112

Attrezzatura: GRUPPO FRESE
Tooling: MILLING CUTTER GROUP

INTESTATURA SOGLIA PROFILATO R72C96
BUTTING FRAME SECTIONS R72C96

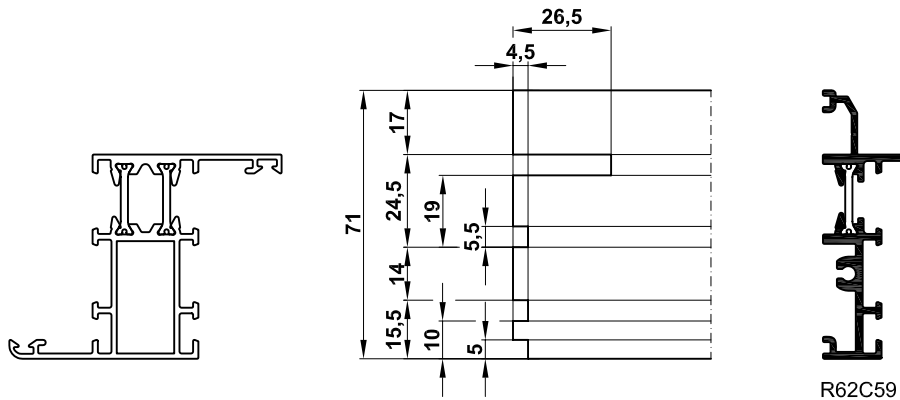

R62C59

Attrezzatura: GRUPPO FRESE
Tooling: MILLING CUTTER GROUP

INTESTATURA SOGLIA PROFILATO 800728
BUTTING FRAME SECTIONS 800728

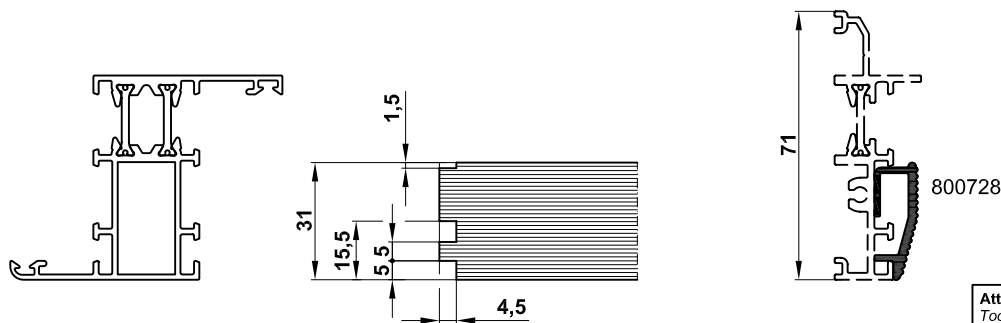

Attrezzatura: GRUPPO FRESE
Tooling: MILLING CUTTER GROUP

INTESTATURA SOGLIA PROFILATO 800729
BUTTING FRAME SECTIONS 800729

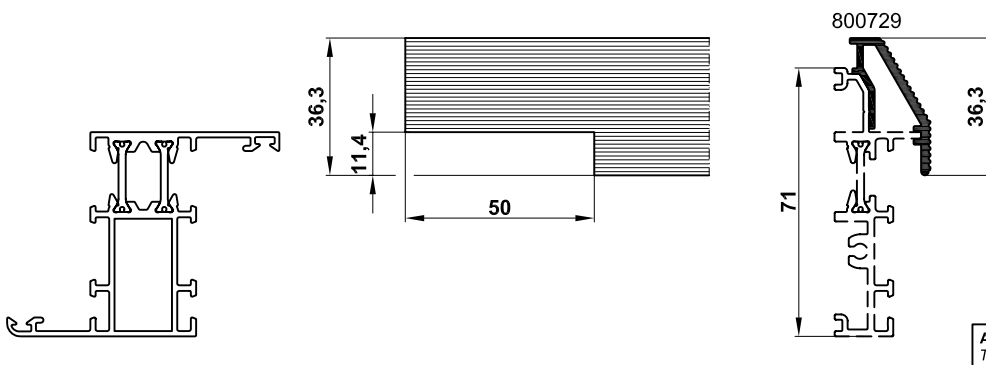

Attrezzatura: FRESA
Tooling: MILLING CUTTER

INTESTATURA VETRO AD INFILARE
BUTTING GLASS TO INSERT

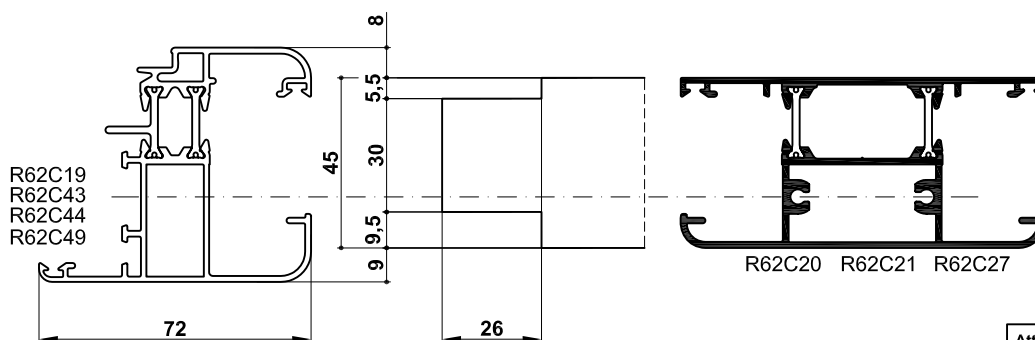

R62C19
R62C43
R62C44
R62C49

R62C20 R62C21 R62C27

Attrezzatura: GRUPPO FRESE
Tooling: MILLING CUTTER GROUP

MONTAGGIO CAVALLOTTO A.3204.ZA
ASSEMBLY TJOINTS A.3204.ZA

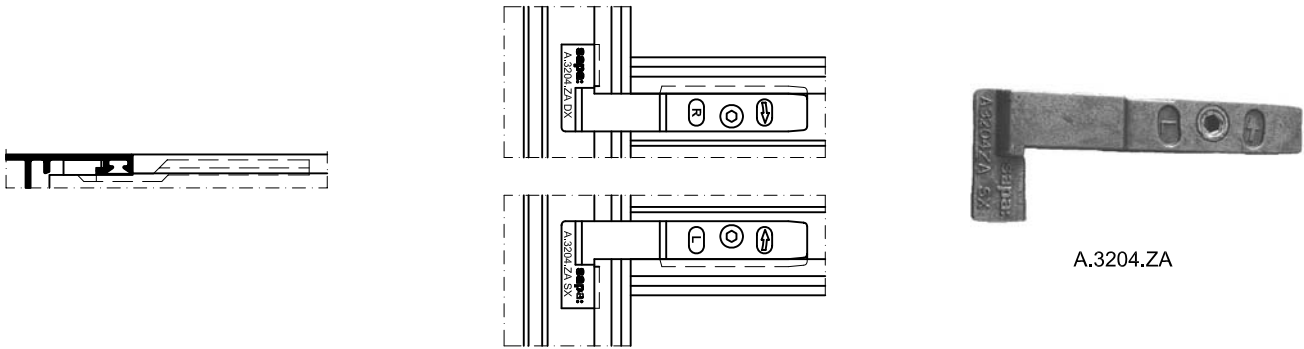

A.3204.ZA

FORATURA PER REGOLO MOBILE
PUNCHING FOR ADJUSTABLE BLOCK

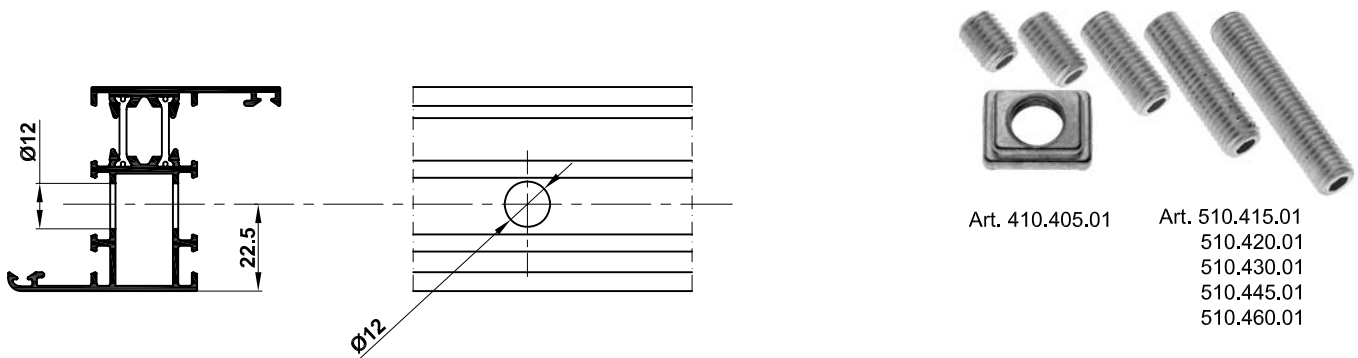

Art. 410.405.01

Art. 510.415.01
510.420.01
510.430.01
510.445.01
510.460.01

Attrezzatura: TRAPANO
Tooling: DRILL

CAVALLOTTI CON VITE
T JOINTS WITH SCREW

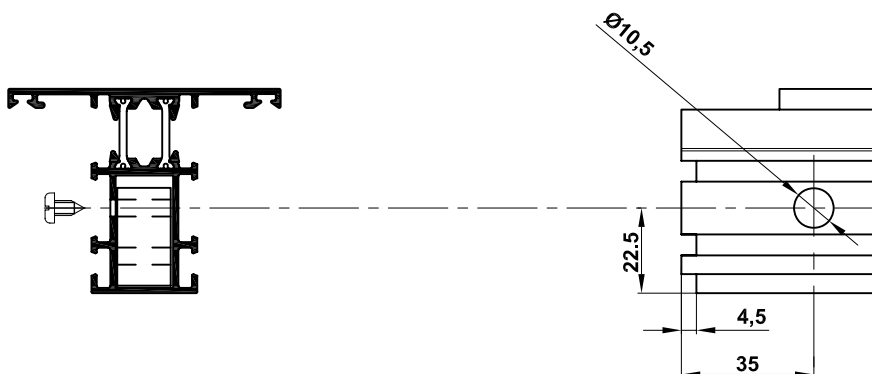

Art. 505.267.01

Attrezzatura: TRAPANO
Tooling: DRILL

FORATURA UNIONE FASCE - ZOCCOLI
PUNCHING FOR HORIZONTAL PANELS CONNECTION - SKIRTING BOARD

R62C10

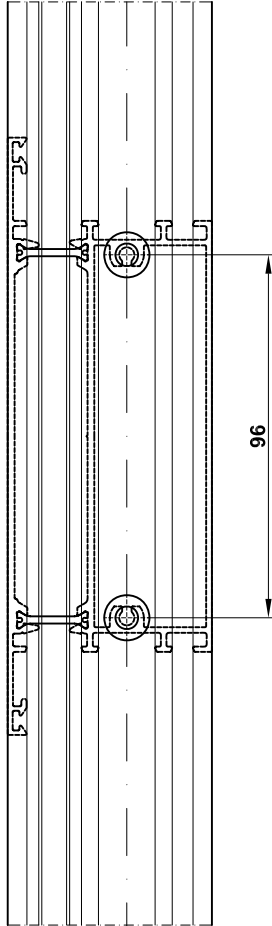

R62C33

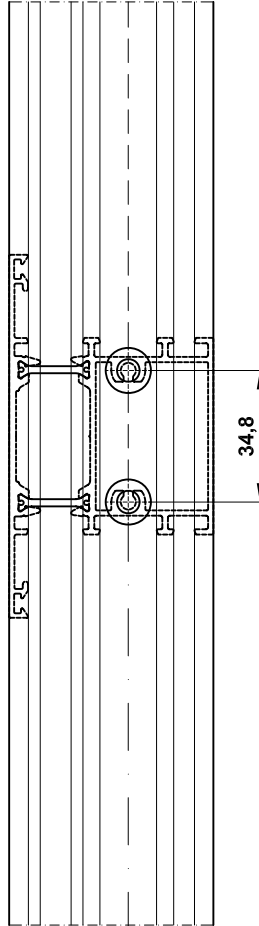

R62C11

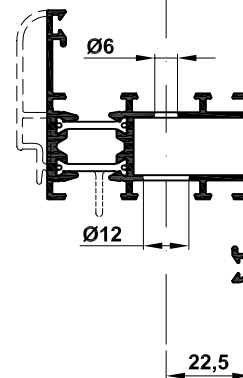
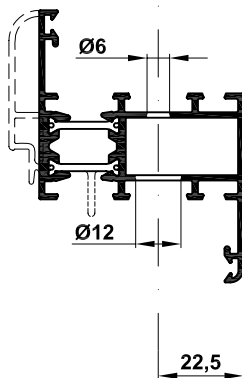
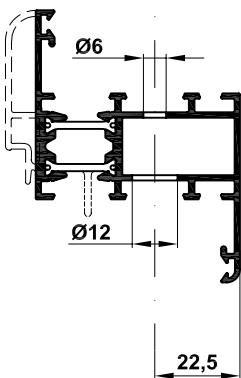
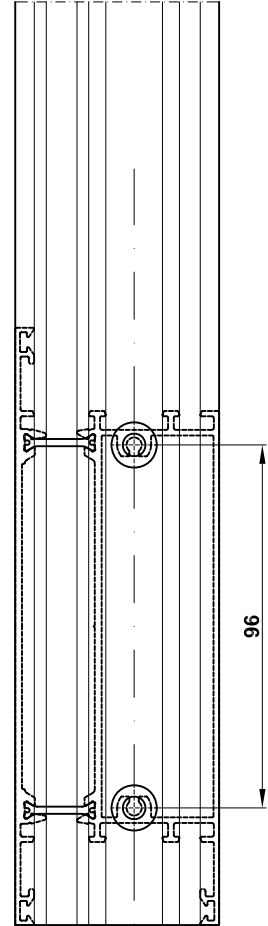

Attrezzatura: TRAPANO
Tooling: DRILL

FORATURA UNIONE FASCE - ZOCCOLI
PUNCHING FOR HORIZONTAL PANELS CONNECTION - SKIRTING BOARD

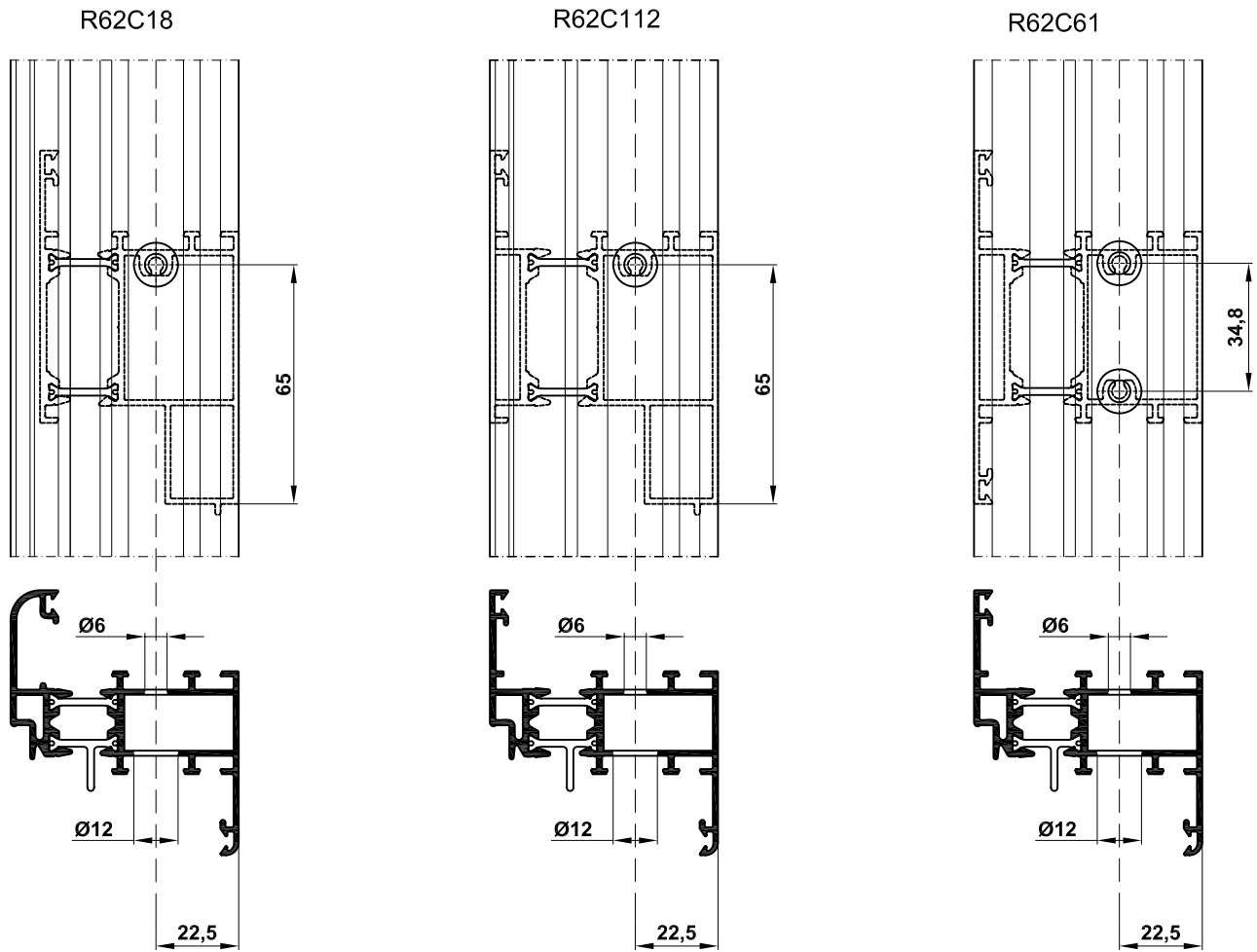

Attrezzatura: TRAPANO
Tooling: DRILL

FORATURA UNIONE FASCE - ZOCCOLI
PUNCHING FOR HORIZONTAL PANELS CONNECTION - SKIRTING BOARD

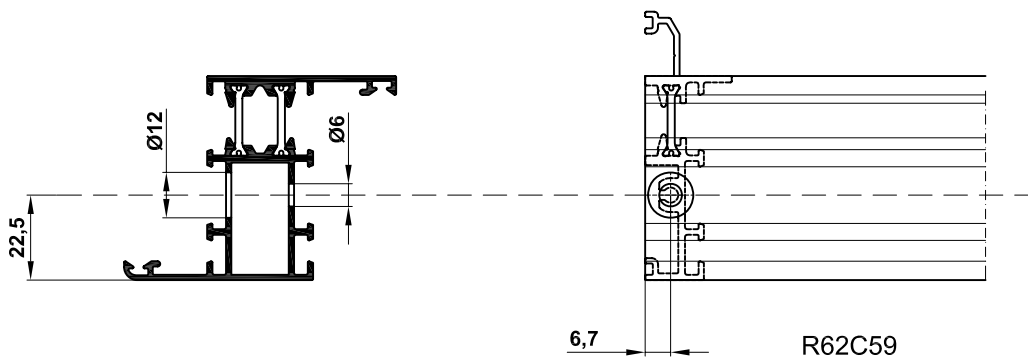

Attrezzatura: TRAPANO
Tooling: DRILL

LAVORAZIONE DELUSSO ACQUA
TOOLING WATER DRAINAGE

Art. 509.260.55
509.261.55

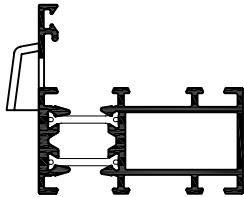
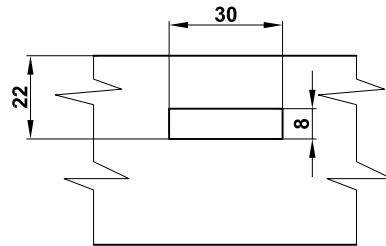

Art. 509.264.55

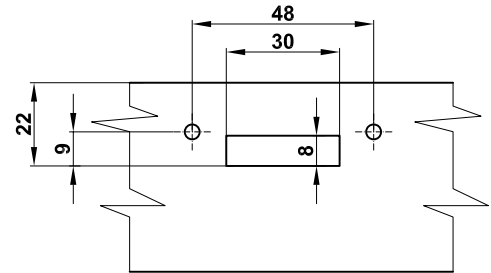

Attrezzatura: PUNZONATRICE
Tooling: PUNCHING MACHINE

Art. 509.260.55
509.261.55

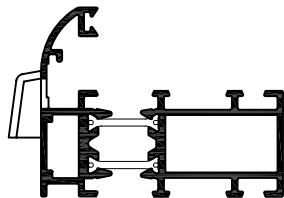
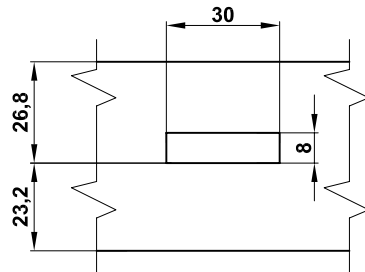

Art. 509.264.55

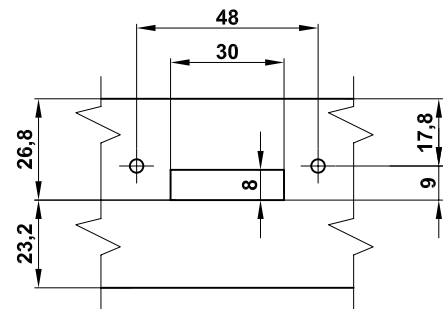

Attrezzatura: PUNZONATRICE
Tooling: PUNCHING MACHINE

Art. 509.260.55
509.261.55

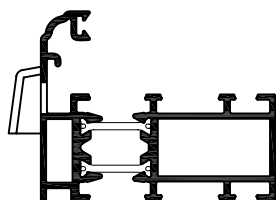
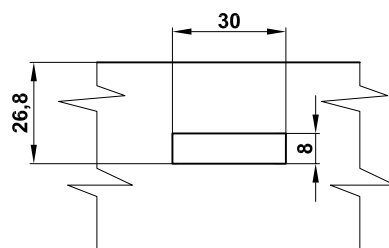

Art. 509.264.55

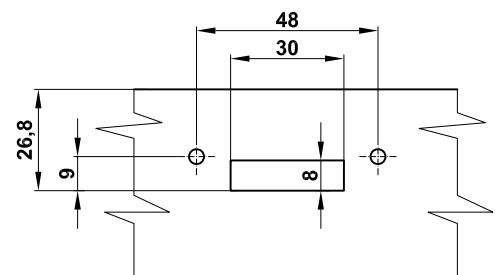

Attrezzatura: PUNZONATRICE
Tooling: PUNCHING MACHINE

LAVORAZIONI PER SCARICHI ACQUA E VENTILAZIONE VETRI
PROCESSING FOR WATER DRAINAGE AND GLASS VENTILATION

Posizione scarichi acqua
Water drainages position

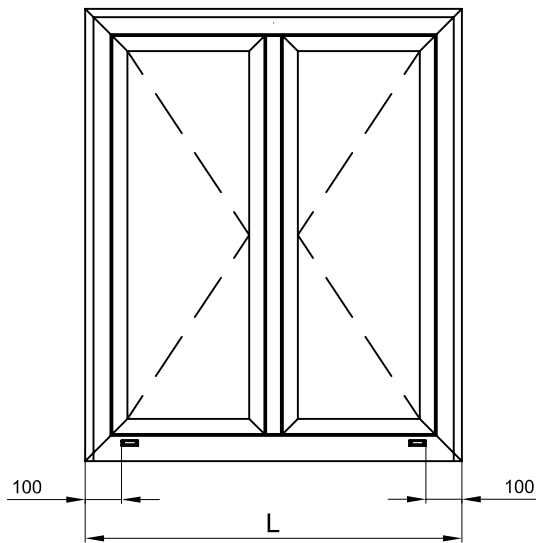

Posizione ventilazione vetri
Glass ventilation position

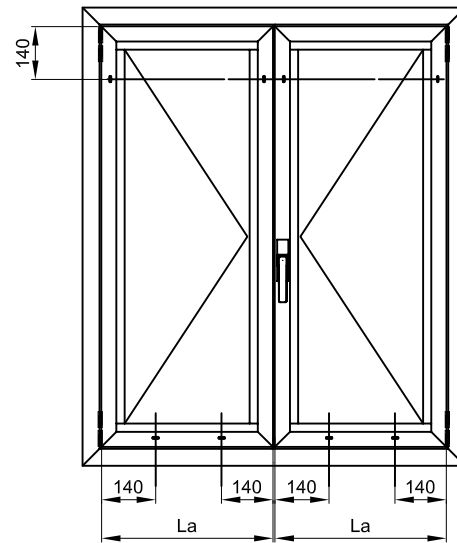

- Scarichi acqua:
N° 2 Per $L \leq 1400$ mm
N° 3 Per $L > 1400$ mm ≤ 2100 mm
N° 4 Per $L > 2100$ mm ≤ 2800 mm
- Water drains:
N° 2 For $L \leq 1400$ mm
N° 3 For $L > 1400$ mm ≤ 2100 mm
N° 4 For $L > 2100$ mm ≤ 2800 mm

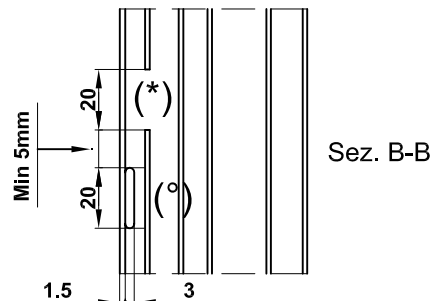
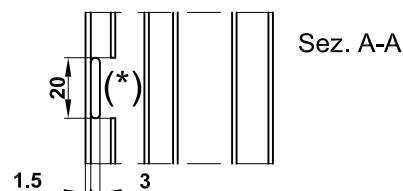
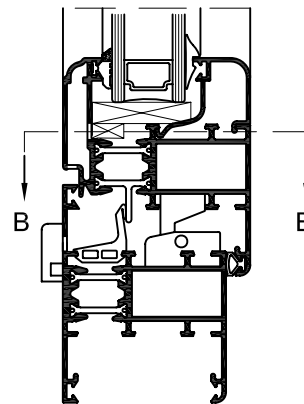
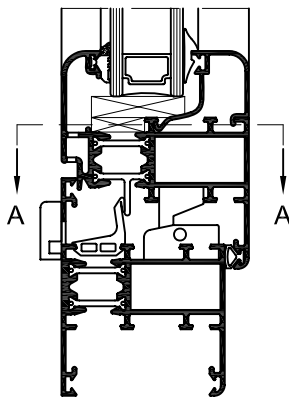

(*) Asportazione dentino solo su profilato anta lato inferiore
in corrispondenza scarico acqua

Teeth removal only on lower wing section
corresponding to the water drainage hole

(*) Asola da 20x 5mm spostata rispetto all'altra lavorazione
(°) Asola da 20x 3mm in corrispondenza dello scarico acqua

(*) Slot 20x5mm not corresponding to the other tooling
(°) Slot 20x3mm corresponding to the water drainage hole

Attrezzatura: TRAPANO - PANTOGRAFO
Tooling: DRILL - PANTOGRAPH

PUNTALI ED INNESTI CREMONESI

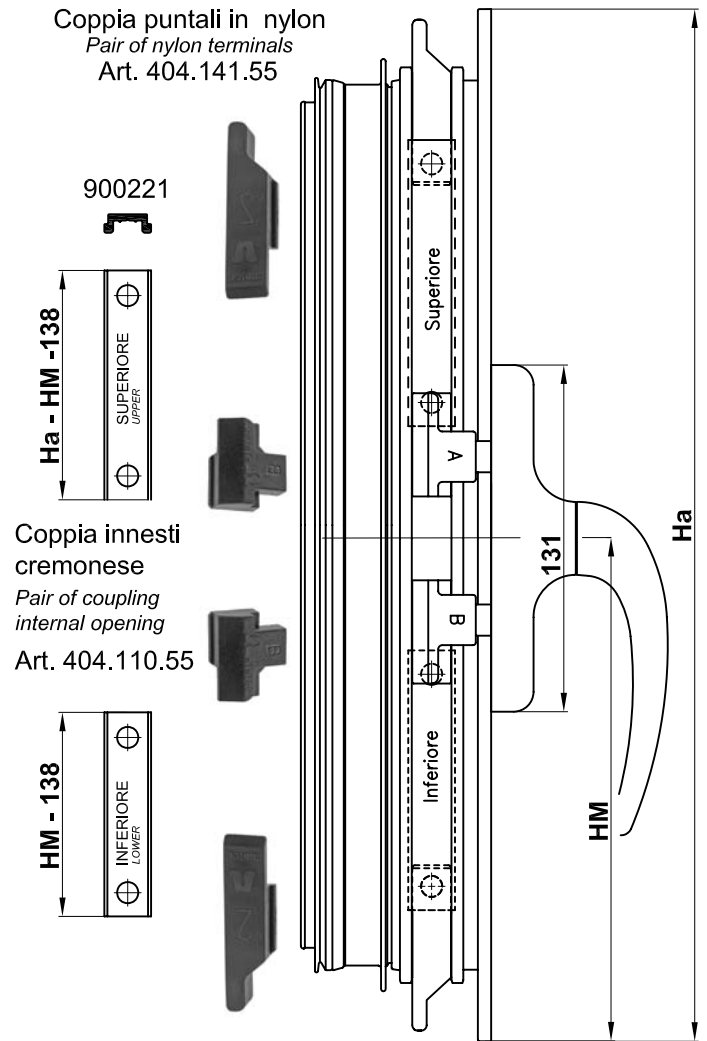
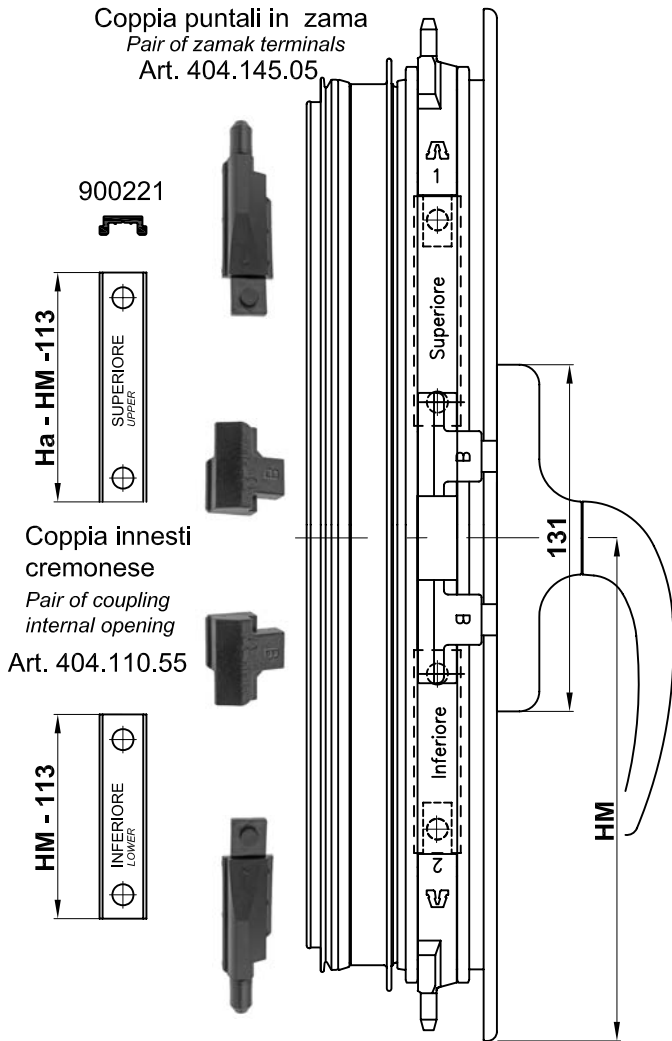

LAVORAZIONE PER CREMONESI
TOOLING FOR CREMONES BOLT

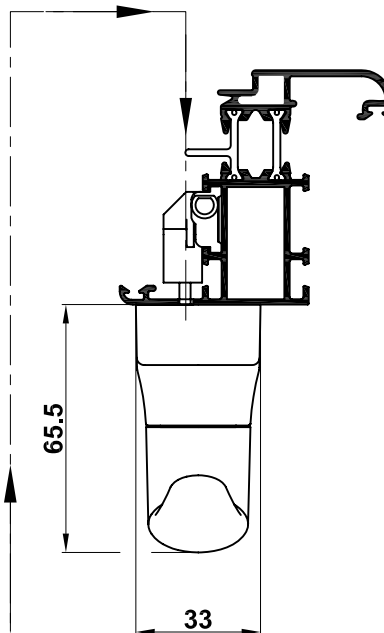
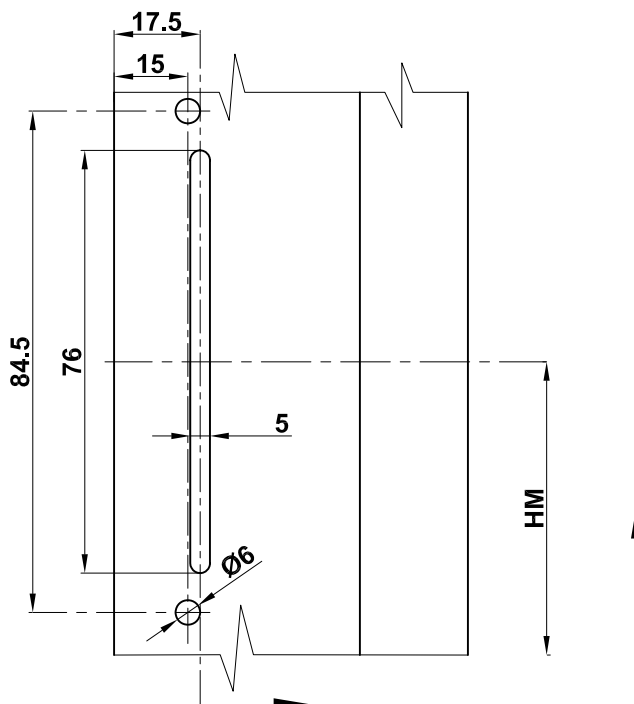

Cremonese reversibile
Reversible cremone
Art. A.4003.ZX

APERTURA ESTERNA
EXTERNAL OPENING

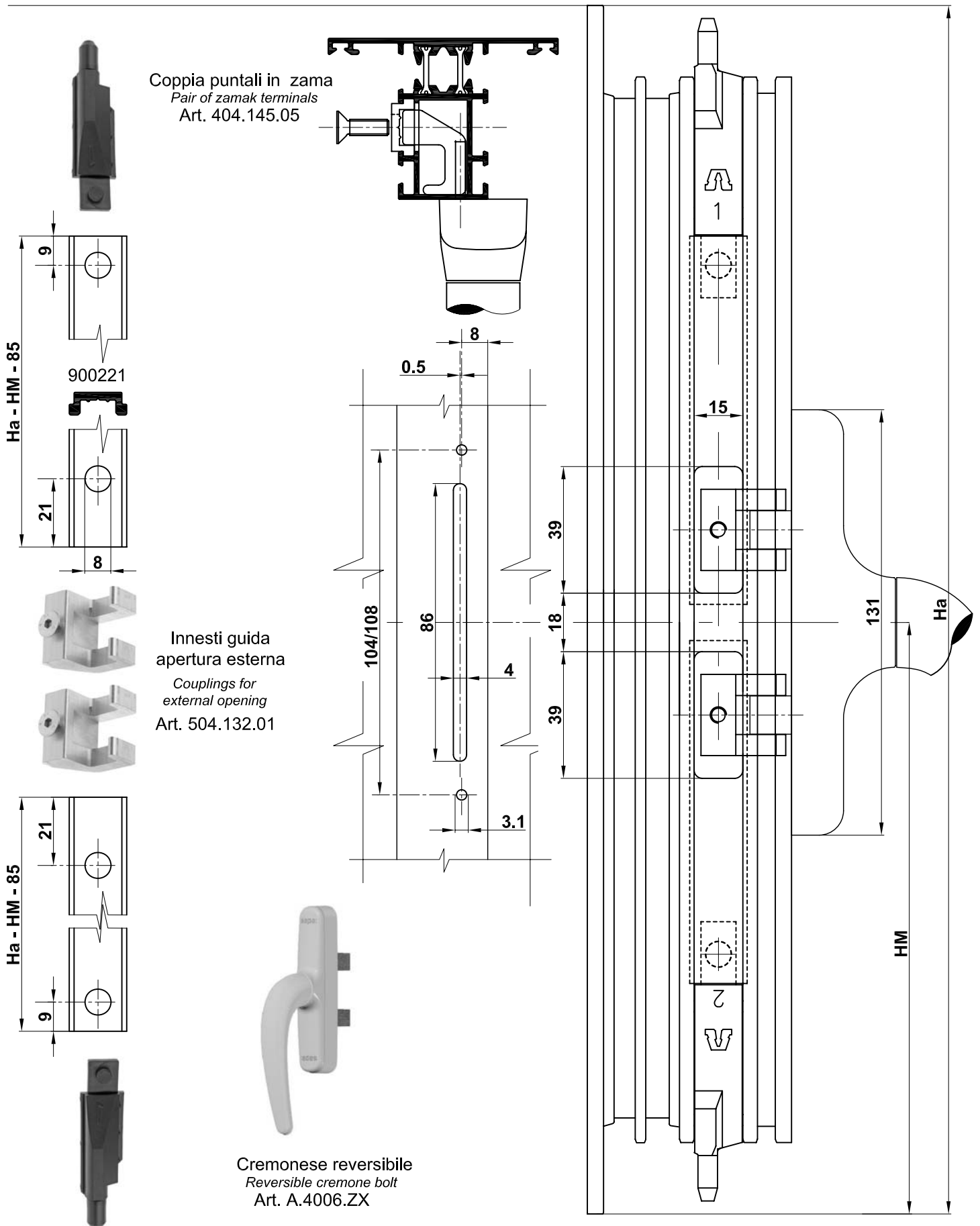

Coppia puntali in zama
Pair of zamak terminals
Art. 404.145.05

Innesti guida
apertura esterna
Couplings for
external opening
Art. 504.132.01

Cremonese reversibile
Reversible cremone bolt
Art. A.4006.ZX

GRUPPO ARTICOLAZIONE RINFORZATO PER SPORGERE PORTATA 90Kg
RELEASABLE ARMS FOR HOPPER WINDOW

Il sistema a sporgere R62TT, è basato sul bilanciamento dell'anta che deve rimanere in equilibrio indipendentemente dalla sua posizione in apertura. Per ottenere le prestazioni ottimali e garantite, il peso dell'anta deve scaricarsi sempre sui bracci e mai sullo scivolo.

Per verificare l'equilibratura dell'anta si può procedere nella seguente maniera: se i bracci sono stati montati troppo in basso l'anta tenderà ad aprirsi autonomamente, viceversa se sono stati montati troppo in alto l'anta tenderà a chiudersi

R62TT, awning systems with load-bearing arms, are based on the balancing of the sash which must remain balanced regardless of its opening position. If the arms have been mounted too low the sash will tend to open on its own while viceversa, if they have been mounted too high up, the sash tends to close.

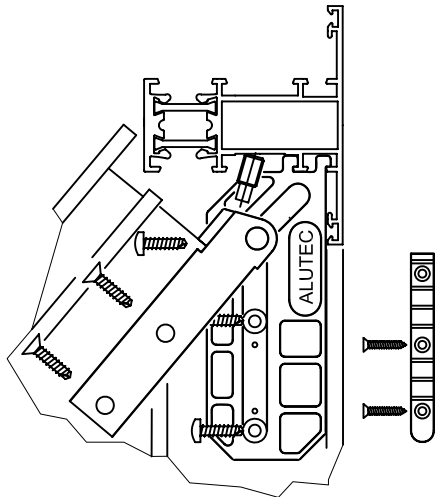
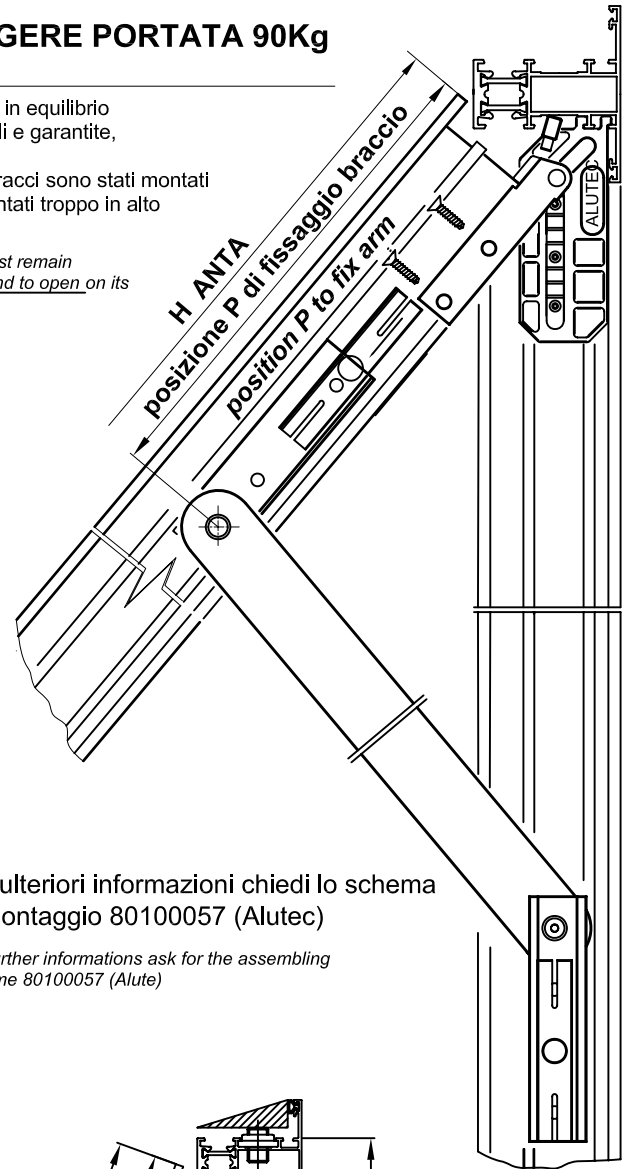

Posizione P Position P	
H anta H wing	P
500	NON FATTIBILE
600	183
700	223
800	265
900	285
1000	300
1100	318
1200	332
1300	342
1400	352
1500	362
1600	370
1700	377
1800	384
1900	392
2000	400

Per ulteriori informazioni chiedi lo schema di montaggio 80100057 (Alutec)

For further informations ask for the assembling scheme 80100057 (Alute)

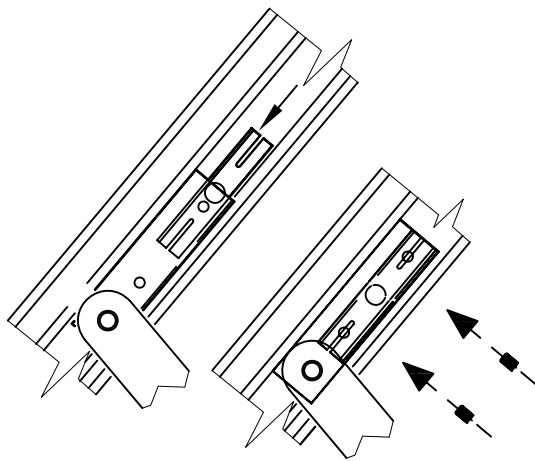

Art. 406.499.05

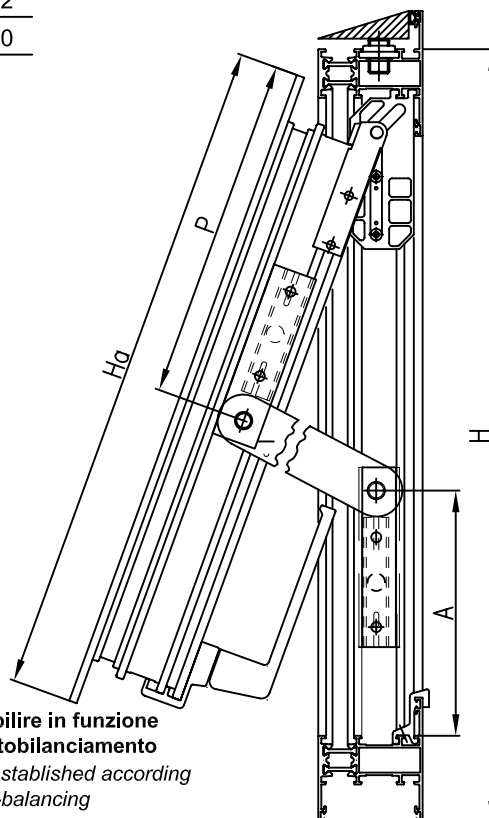

A = Da stabilire in funzione dell'autobilanciamento

A = To be established according to self-balancing

BRACCI SGANCIABILI AMMORTIZZATI PER VASISTAS
RELEASABLE AND AMORTIZED ARMS FOR VASISTAS

CAMPO DI APPLICAZIONE APPLICATION RANGE									
H	Art. A.3907.IA H da 1000 a 2000mm			Art. A.3906.IA H da 350 a 1600mm			Art. A.3905.IA H da 250 a 500mm		
	A	B	C	A	B	C	A	B	C
250							0	40	145
300							0	40	132
							50	90	171
							0	40	124
350				0	150	250	0	40	124
							50	90	152
							100	140	198
400				0	150	220	0	40	119
				50	200	284	50	90	140
							100	140	172
450				0	150	202	0	40	115
				50	200	246	50	90	132
				100	250	318	100	140	157
							150	190	193
500				0	150	190	0	40	112
				50	200	223	50	90	127
				100	250	272	100	140	146
				150	300	353	150	190	173
550				0	150	181			
				50	200	208			
				100	250	244			
				150	300	299			
600				0	150	174			
				50	200	197			
				100	250	226			
				150	300	266			
				200	350	325			
700				0	150	165			
				100	250	202			
				200	350	262			
800				0	150	159			
				100	250	188			
				200	350	230			
900				0	150	155			
				100	250	178			
				200	350	210			
				300	450	257			
1000	0	340	238	0	150	151			
	100	440	278	100	250	170			
	200	540	334	200	350	196			
	300	640	421	300	450	232			
1100	0	340	229	0	150	148			
	100	440	261	100	250	165			
	200	540	305	200	350	187			
	300	640	366	300	450	215			
1200	0	340	223	0	150	146			
	100	440	250	100	250	161			
	200	540	284	200	350	180			
	300	640	332	300	450	203			
	400	740	400	400	550	235			
1300	0	340	217	0	150	145			
	100	440	240	100	250	158			
	200	540	270	200	350	174			
	300	640	308	300	450	194			
	400	740	359	400	550	220			
1400	0	340	213	0	150	144			
	100	440	233	100	250	156			
	200	540	258	200	350	170			
	300	640	290	300	450	187			
	400	740	331	400	550	209			
1500	0	340	209	0	150	142			
	100	440	227	100	250	153			
	200	540	249	200	350	166			
	300	640	276	300	450	181			
	400	740	310	400	550	200			
	500	840	354	500	650	223			
1600	0	340	200	0	150	141			
	100	440	223	100	250	151			
	200	540	242	200	350	163			
	300	640	265	300	450	177			
	400	740	294	400	550	193			
	500	840	330	500	650	213			
1700	0	340	204						
	100	440	219						
	200	540	236						
	300	640	257						
	400	740	282						
	500	840	312						
1800	0	340	201						
	100	440	215						
	200	540	231						
	300	640	250						
	400	740	271						
	500	840	298						
	600	940	330						
1900	0	340	199						
	100	440	212						
	200	540	227						
	300	640	243						
	400	740	263						
	500	840	286						
	600	940	315						
2000	0	340	198						
	100	440	210						
	200	540	223						
	300	640	243						
	400	740	263						
	500	840	286						
	600	940	315						

- Art. A.3905.IA Braccio corto
short arm
- Art. A.3906.IA Braccio medio
medium arm
- Art. A.3907.IA Braccio lungo
long arm

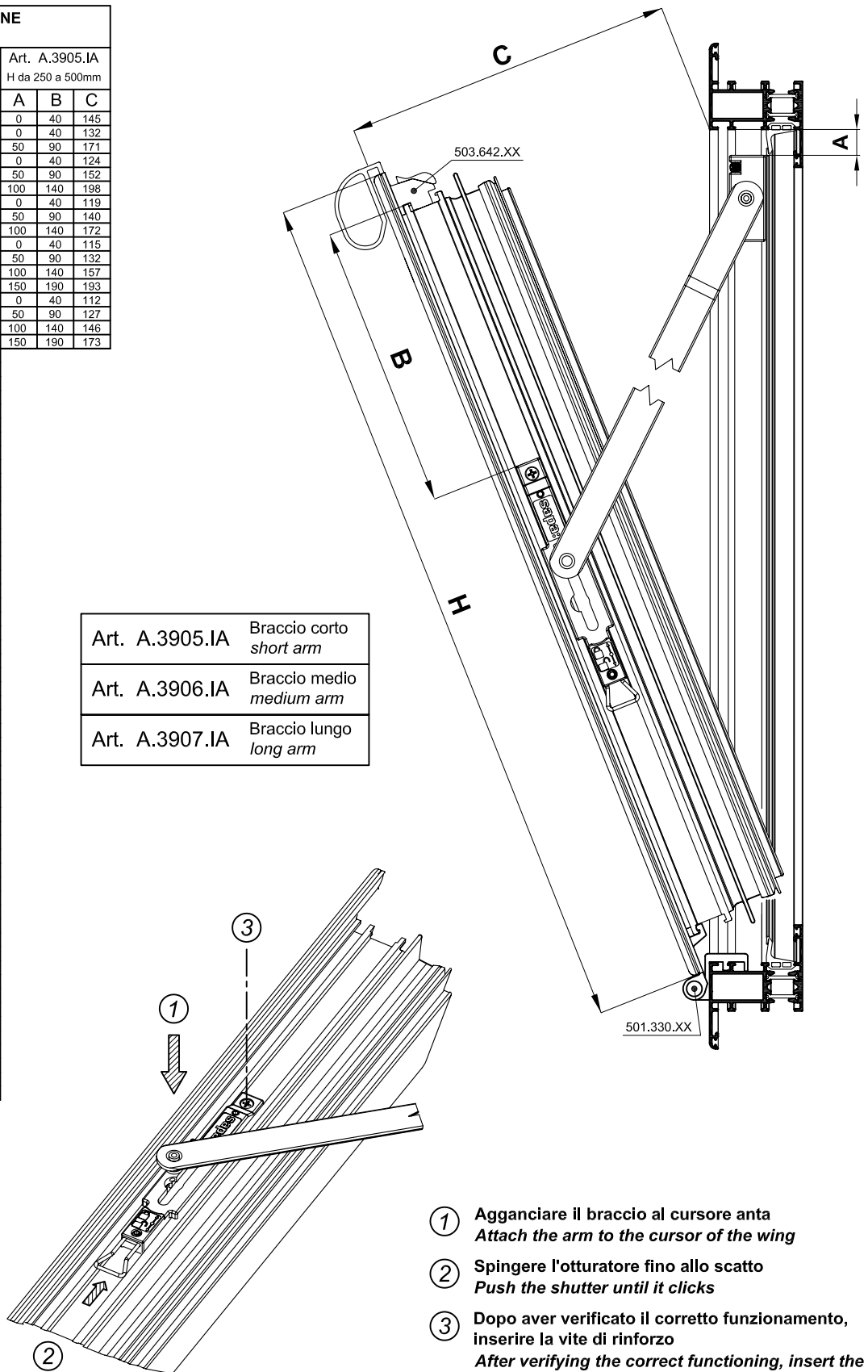

- ① Agganciare il braccio al cursore anta
Attach the arm to the cursor of the wing
- ② Spingere l'otturatore fino allo scatto
Push the shutter until it clicks
- ③ Dopo aver verificato il corretto funzionamento,
inserire la vite di rinforzo
*After verifying the correct functioning, insert the
reinforcement screw*

Per sganciare, eseguire l'operazione inversa.
To release, perform the inverse operation.

SERRATURE DA INFILARE MULTIPUNTO AD INGRANAGGI - COMPLANARE 1 e 2 ANTE
LOCK

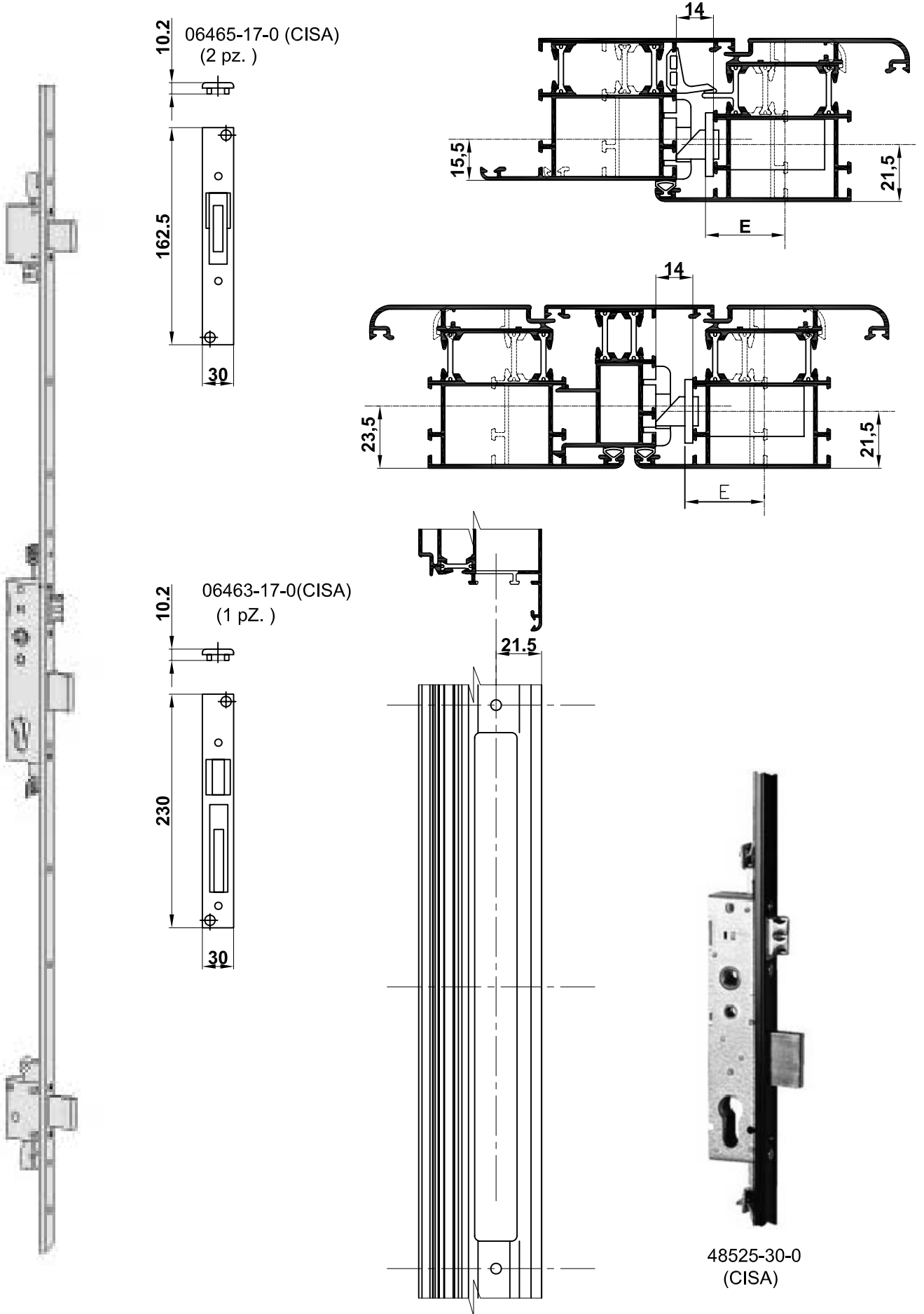

**APERTURA ESTERNA R62C62
EXTERNAL OPENING**

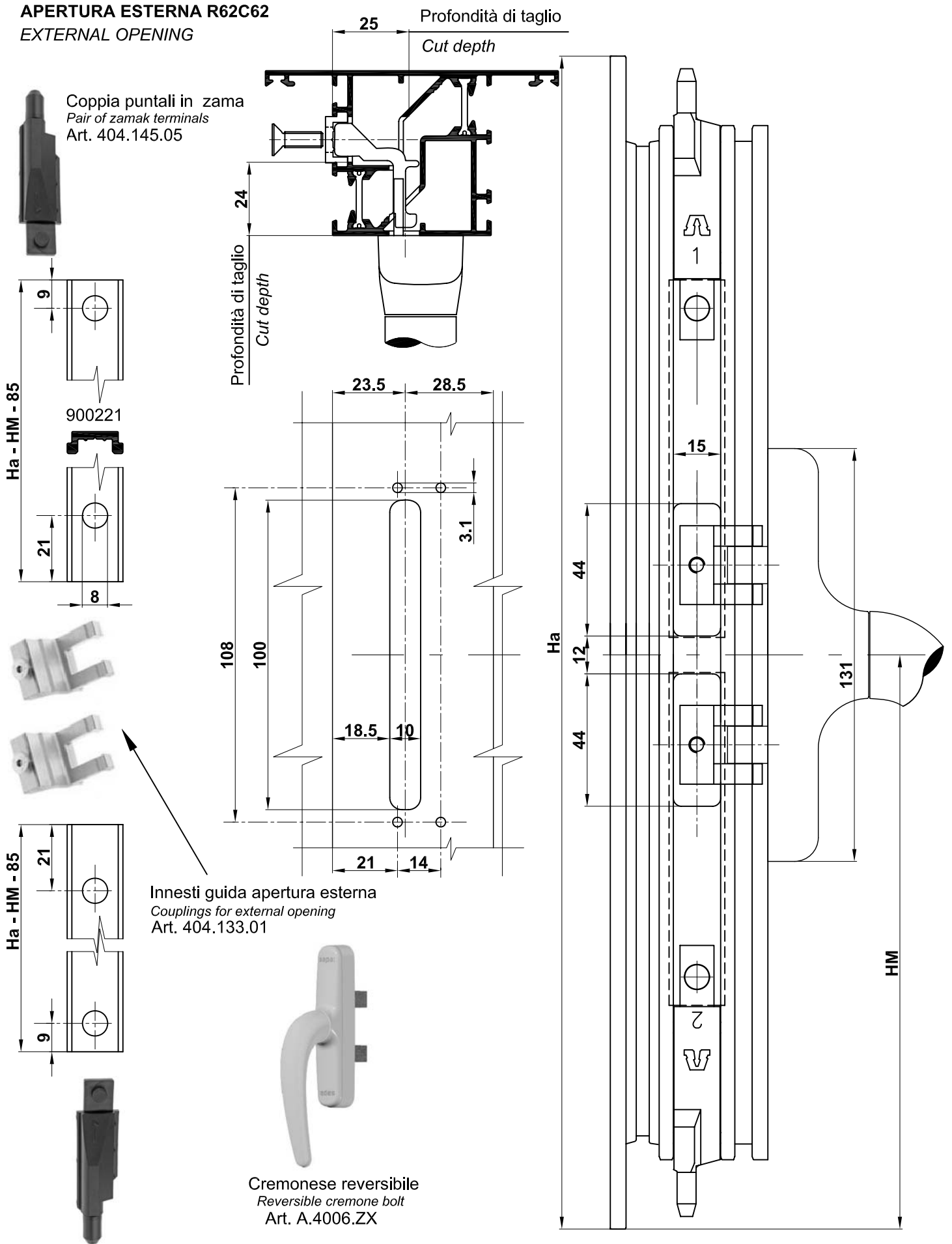

POSIZIONAMENTO FISSAGGIO ART. 508.025.01
MOUNTING POSITION ART. 508.025.01

ART. 508.025.01

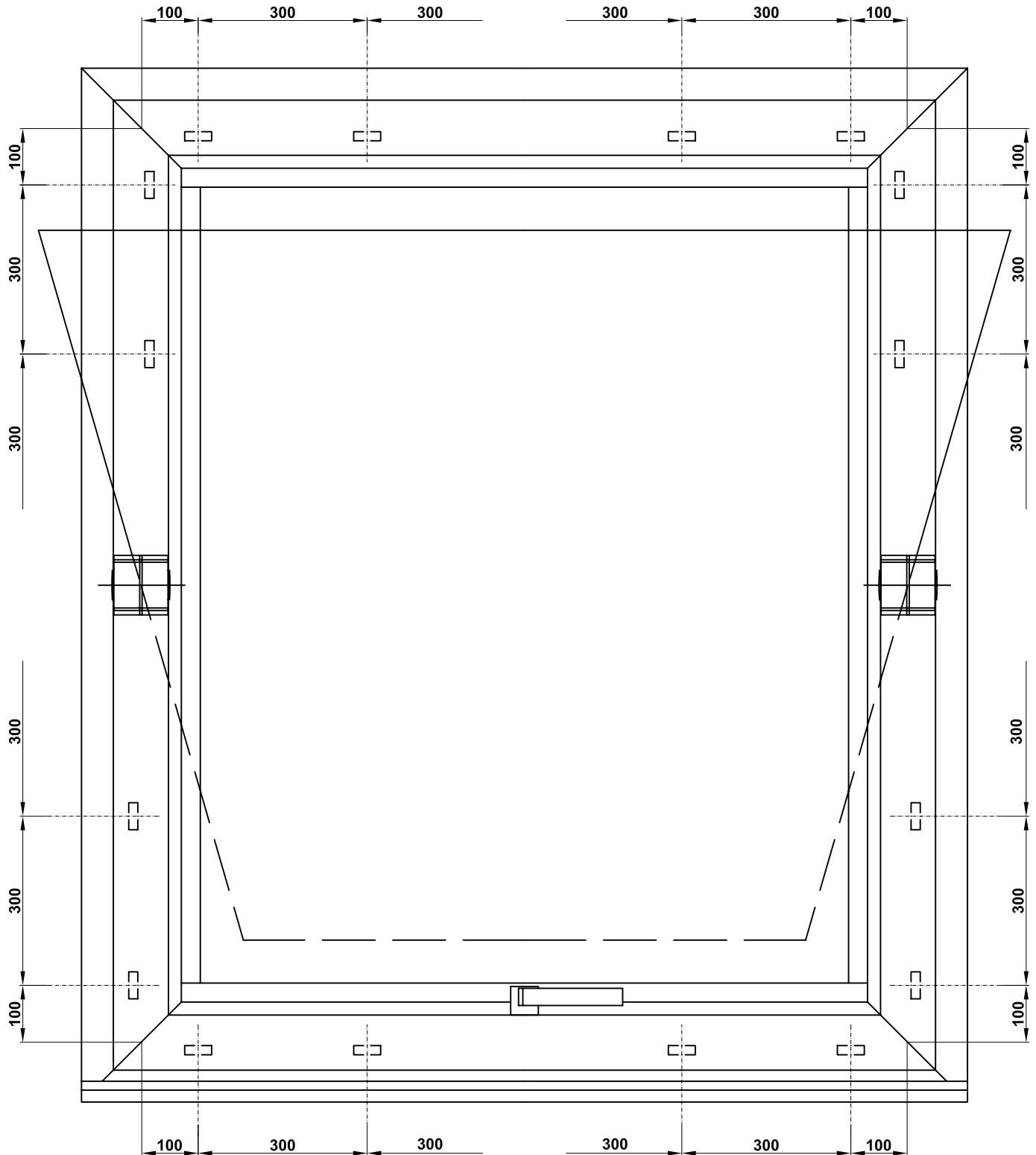

Sapa sviluppa, produce e commercializza in tutto il mondo profili a valore aggiunto. Sapa si avvale di oltre 13.000 dipendenti e centri di produzione in 30 paesi che collaborano per soddisfare tutte le esigenze dei clienti dei mercati più disparati.

Sapa Profili srl sviluppa, produce e commercializza profili per l'edilizia sempre innovativi. Original Systems garantisce una vasta e completa gamma di soluzioni residenziali e non, per rispettare le normative e per soddisfare le esigenze più complesse del mercato dell'involucro edilizio. I marchi di Original Systems, Sistema RTT, Sistema R, Teknowall, Teknowindow ed Alfil, sono distribuiti solo attraverso la rete Ufficiale di Distributori Sapa.

sapa: ... e scegli con serenità.